

## Radio Touch

Order no.: 2880 xx

### Operation and installation instructions

#### 1 Safety instructions

Electrical equipment must only be installed and assembled by a qualified electrician in accordance with the relevant installation standards, regulations, directives and safety and accident prevention directives of the country.

Failure to comply with these instructions may result in damage to the device, fire, or other hazards.

Disconnect load before working on the device. Take all circuit breakers that feed dangerous voltages to the device into account.

These operating instructions are an integral component of the product, and must be retained by the end user.

#### 2 Structure of the device (Figure 1)

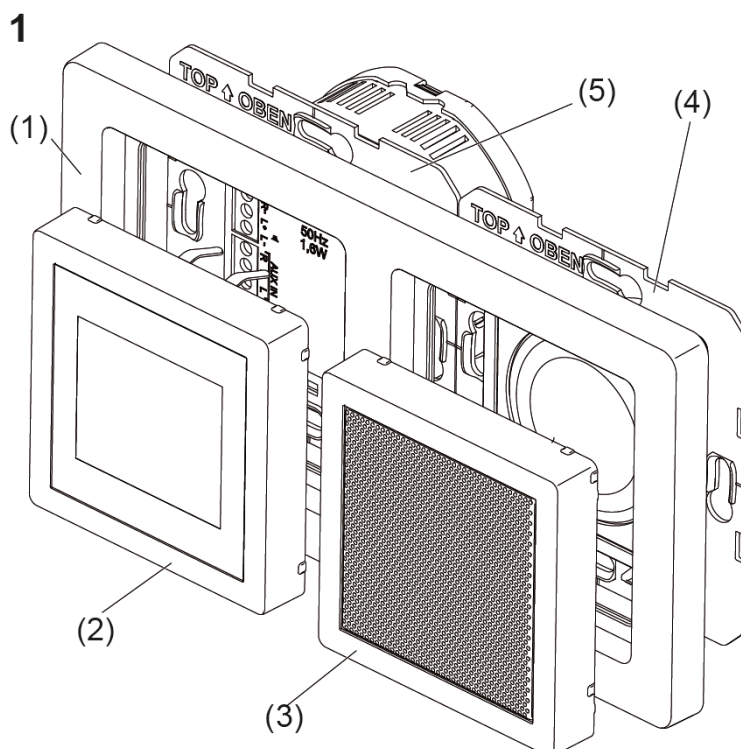

- (1) Frame 2-gang
- (2) Radio Touch cover
- (3) Centre plate for loudspeaker
- (4) Loudspeaker insert
- (5) Radio Touch insert

**i** Scope of delivery: radio and loudspeaker with Design parts and fastening screws.

### 3 Function

The radio receives FM radio stations and outputs them via the connected loudspeaker. Additional functions:

- Capacitive touch display
- Manual and automatic station search
- 8 memory slots
- Display of reception frequency and RDS information
- Display of date and time in Standby mode
- Automatic date and time setting on RDS reception
- Alarm with radio or acoustic signal
- Timer (countdown) with acoustic signal when expired (also during radio reception)
- Sleep mode with automatic switch-off
- Display brightness settable in 10 levels and 8 times
- Extension connection, e.g. for switch, controller
- AUX-IN for external audio sources, e.g. docking station or MP3 player to multimedia socket outlet

#### Correct use





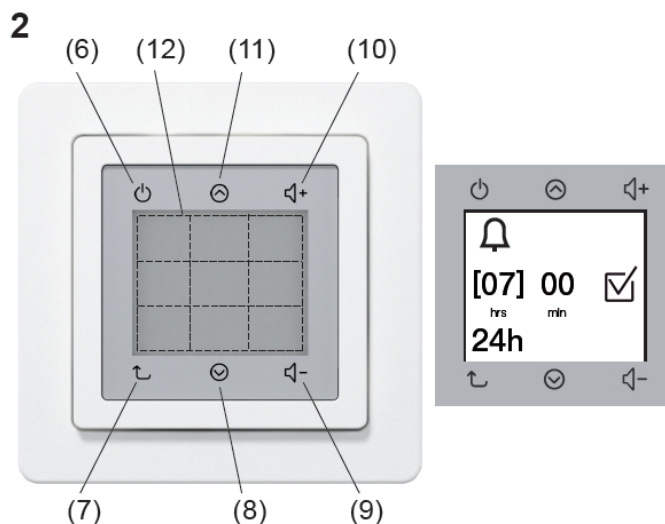

- Only suitable for use in indoor areas
- Flush-mounting in wall box according to DIN 49073
- Radio and loudspeaker each mounted in a wall box

### 4 Operation

Operation solely using touch operating surfaces.

#### Operating concept (Figure 2)



- (6) Switch on/switch off 
- (7) Jump back to the higher-level operating level 
- (8) Scroll down/reduce value 
- (9) Decrease volume 
- (10) Increase volume 
- (11) Scroll up/Increase value 
- (12) Touch display with variable display/operating areas

The six symbolic operating elements, arranged at the top and bottom of the display, represent fixed buttons for frequent operations.

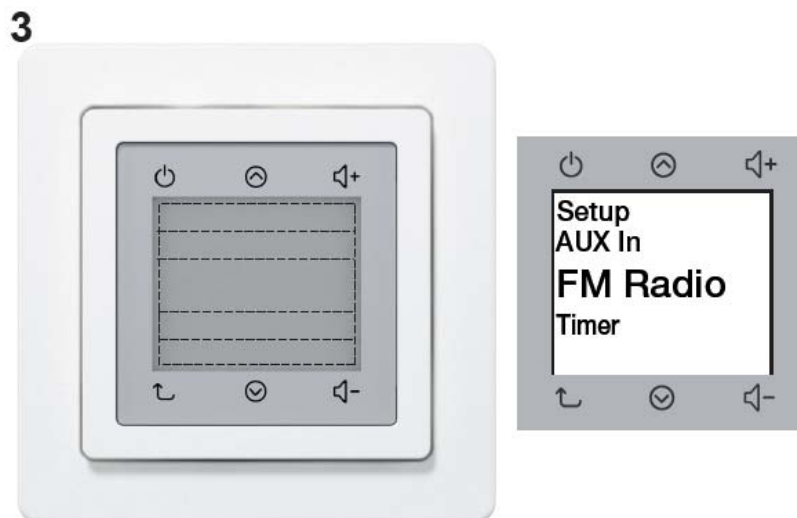



Figure 3

Either a 3- or 5-line menu (Figure 3) or up to 9 fields for the settings (Figure 2) are shown on the display.

**i** Longer lines of text are shown in a loop after a second's delay.

### Switching on the radio



The radio is in Standby mode, the date and time are displayed.

- Touch the display or button  (Figure 2, 6).  
The radio outputs the most recently set station.

**i** Details such as station type, station name, transmitter frequency, song name, storage location and reproduction mode are displayed with RDS reception.

### Selecting menu items

The radio is switched on.

- Touch the  button until main menu appears (Figure 3).
- Touch the  /  button or the display.  
The active display in the central operating panel - shown in bold - changes.
- Touch the active display with the desired menu item.  
A new menu opens.

**i** If necessary, an additional selection must be made in the menu, before settings are possible.

### Changing settings

The menu item is selected - e.g. **Countdown**. The first setting is active - e.g. hours **hrs**.

- Use the  /  button to set the desired number.

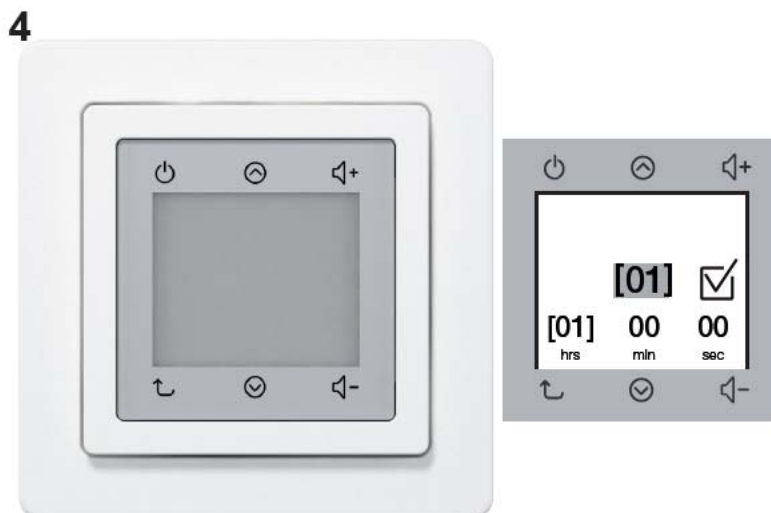

Figure 4

- Using the control panel, apply the number of another setting, e.g. **min** or **sec** or save the settings with  (Figure 4).
- Adjust other settings accordingly.
- i** The order and number of settings is arbitrary.
- i** The active setting is displayed in square brackets.

### Setting the volume

The radio is switched on.

- Press the  $\text{🔊+} / \text{🔊-}$  button (Figure 2, 10/9).  
The sound is played back louder/more quietly.
- i** With control panel  $\text{🔊}$ , switched to mute during volume setting.
- i** Pressing the volume bar at the bottom in the middle or at the top - when setting the volume - adjusts the volume to 30%, 60% or 100%.







### Setting the date and time manually

The radio is switched on.

- Touch the  $\text{🏠}$  button until main menu appears (Figure 3).
- Select the **Timer** control panel with the  $\text{🕒} / \text{🕒}$  buttons and press it.
- Select **Time/Date** with  $\text{🕒} / \text{🕒}$  and press it.
- Select **Manual** with  $\text{🕒} / \text{🕒}$  and press it.
- Using  $\text{🕒} / \text{🕒}$ , select the date format **EU / US** and, using another control panel, apply, e.g. **year**.
- Using  $\text{🕒} / \text{🕒}$ , select the year and apply with **month**.
- Using  $\text{🕒} / \text{🕒}$ , select the month and apply with **day**.
- Using  $\text{🕒} / \text{🕒}$ , select the day and apply with **hrs**.
- Using  $\text{🕒} / \text{🕒}$ , select the hours and apply with **min**.
- Using  $\text{🕒} / \text{🕒}$ , select the minutes and press  to save all the settings.

### Setting an FM station with automatic search

The radio is switched on.









- Touch the  button until main menu appears (Figure 3).
- Select the control panel **FM Radio** using  /  and press it.
- Select the **Automatic Scan** control panel with  /  and press it.  
The first station to be found will be played back and shown in the display.
- Pressing  continues the automatic search without saving.

or:

- Save the station (see Saving stations).

### Setting an FM station with manual search

The radio is switched on.



- Touch the  button until main menu appears (Figure 3).
- Select the control panel **FM Radio** using  /  and press it.
- Select the control panel **Manual Seek** using  /  and press it.
- Increase/reduce the reception frequency in 0.1 MHz steps using  /  until a station is received without interference.
- Press  to continue the manual search without saving.

or:

- Save the station (see Saving stations).

### Saving stations

The searched for station is played back.





- Press the station display in the control panel.
- Press **Save**.
- Select **New station** using  /  and press it to save.



or:

- Select the saved radio station with  /  and press it to overwrite.

### Opening a saved station

The radio is switched on.

- Touch the  button until main menu appears (Figure 3).
- Select the control panel **FM Radio** using  /  and press it.
- Select the saved station using  /  and press it.

 If a storage slot is opened, it is possible to skip to the next or previous storage slot using  / .















### Deleting stations

The station to be deleted is played back.

- Press the control panel with the station display.
- Delete this storage slot using **Delete**.









### Setting the alarm

The radio is switched on.







- Touch the  button until main menu appears (Figure 3).
  - Select the **Timer** control panel with the  /  buttons and press it.
  - Select **Wake Up** with  /  and press it.
  - Select **On** with  /  and press it.
  - If necessary, switch to **24h/AM/PM** display.
  - Press the time to be set (hours, minutes or seconds). Set the time using  /  (Figure 2).
  - Press  and, using  / , select and press a radio station or the electronic alarm signal.
  - Press  to apply the settings.
- i** When the alarm is active and the radio switched off, the alarm symbol  is displayed.
- i** Alarm operations can be terminated using  or moved by intervals of 5 minutes (snooze) by pressing another control panel.

### Setting a countdown



The radio is switched on.

- Touch the  button until main menu appears (Figure 3).
  - Select the **Timer** control panel with the  /  buttons and press it.
  - Select **Countdown** with  /  and press it.
  - Press the time to be set (hours, minutes or seconds). Using  / , set the time shown in brackets (Figure 4).
  - If necessary, set additional times.
  - Apply the time setting using  and activate the countdown.  
After the time has elapsed, an acoustic signal will sound - even if radio is being received.
- i** The **Sleep Mode** function can be set accordingly.

### Setting the language

- Touch the  button until main menu appears (Figure 3).
  - Select the **Setup** using the  /  buttons and press it.
  - Select the **Language** using  /  and press it.
  - Select the appropriate language with  /  and press it.
- i** The **Backlight**, **Reset of Defaults** and **Sound** functions can be set in the same way.

### Setting to external audio device

- Touch the  button until main menu appears (Figure 3).
- Select the **AUX In** control panel using the  /  buttons and press it.

## 5 Information for electricians

### 5.1 Installation and electrical connection

**DANGER!**

Touching live parts can result in an electric shock.

An electric shock can lead to death.

Before working on the device or load, disconnect all associated circuit breakers.  
Cover all live parts in the area!

Connections on the radio insert (Figures 5 and 6) for:

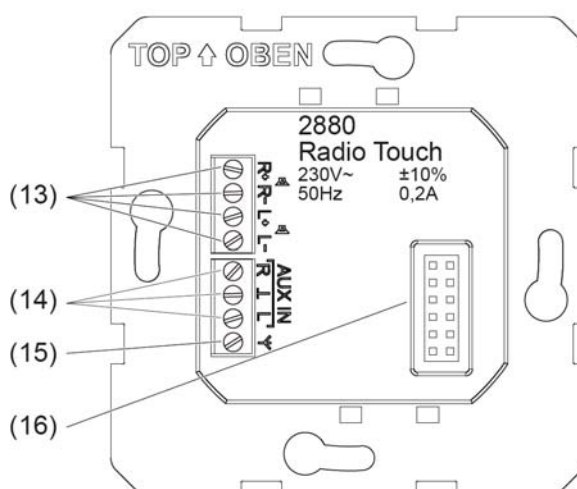
**5**

(13) Loudspeaker (L, R)

(14) External audio devices **AUX IN**

(15) Antenna

(16) Radio application module (12-pole jack)

6

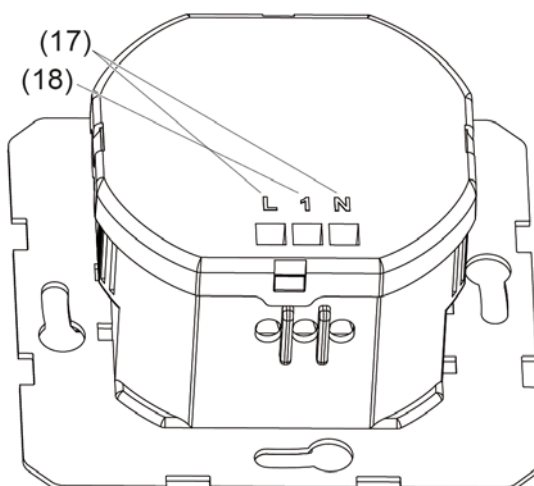

(17) 230 V~ lead

(18) Extension unit

### Connecting radio to lead

The lead is protected by means of a circuit breaker (max 16 A).

- Connect the 230 V~ lead to the **L** and **N** terminals (Figure 6, 17).
  - If necessary, connect the extension unit (Figure 6, 18).
- i** Do not connect the load cable directly to the extension unit terminal but connect it directly to the switch or in connection boxes.
- i** When switching on energy-saving lamps, electronic transformers and ballasts on the extension unit input, interference pulses may occur. We recommend wiring the extension unit input with a separate contact e.g. with a 2-pole switch or additional relay.

### Connecting loudspeakers and auxiliary devices



#### **DANGER!**

**If the loudspeakers are connected to the operating voltage in a shared cable, the operating voltage can reach the loudspeaker cables. Electric shock possible through touching the loudspeaker cable.**

**An electric shock can lead to death.**

**Route a separate loudspeaker wire.**

At least one loudspeaker must be connected for radio operation.

- Connect loudspeakers to the terminals **⊕** (red) and **⊖** (white) (Figure 5, 13).



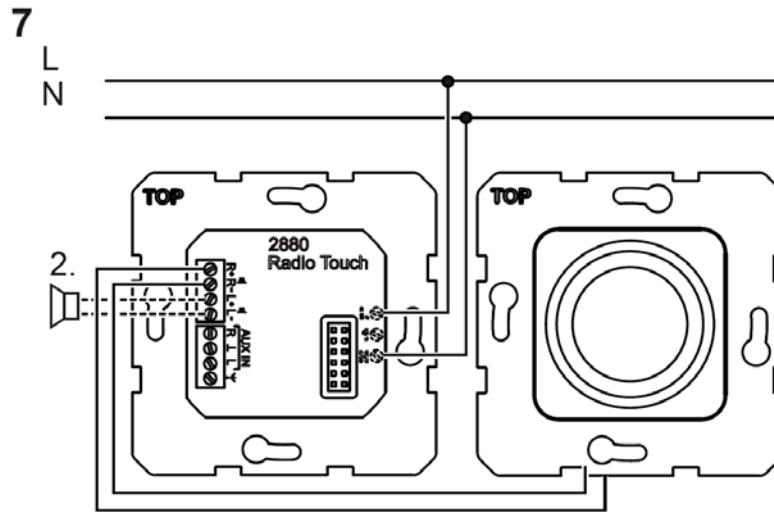

Figure 7

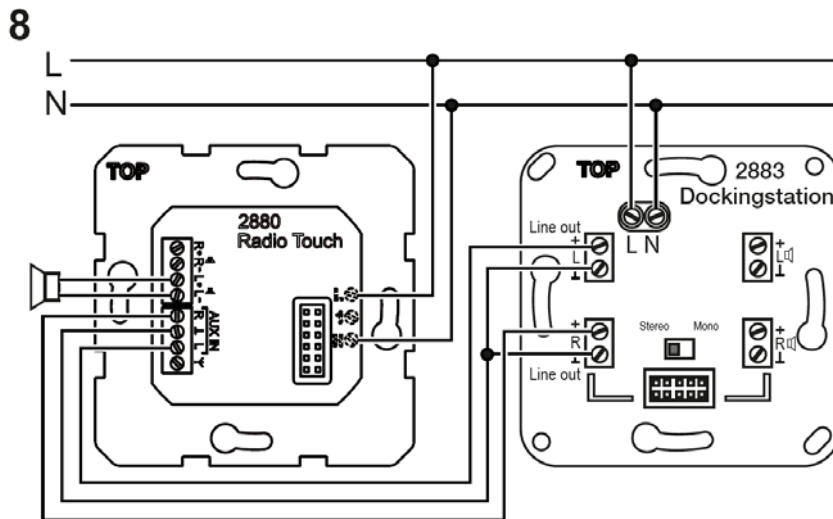

Figure 8

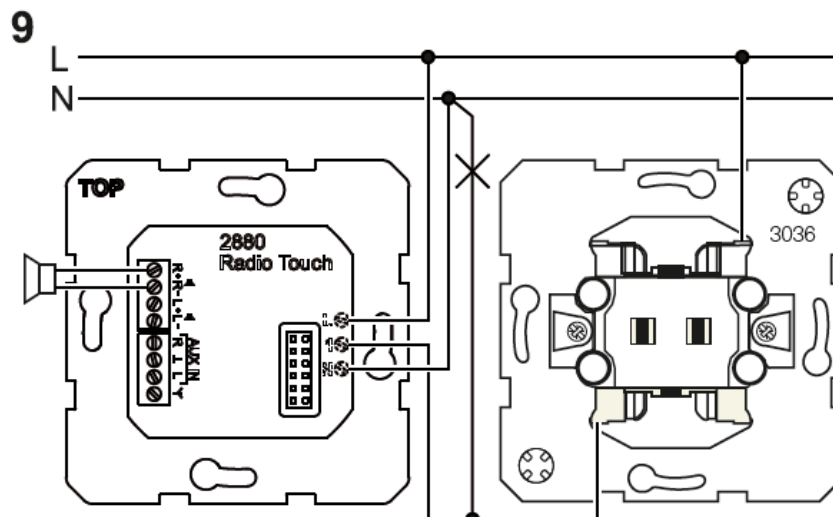

Figure 9

- If necessary, connect other external devices (Figures 7, 8 or 9).
- ⓘ In stereo mode with two loudspeakers, the control panel with the station display can be used to switch manually to mono operation.
- ⓘ Only use wires that are adjusted for the mains voltage method of laying.
- ⓘ Wires must be mounted in such a way, e.g. with cable ties, that a detached wire will not touch another potential in the event of a fault.
- ⓘ Use shielded wires for interference-free signal transmission. Connect the shield to the terminal ⊥ according to the terminal labelling.
- ⓘ In combinations or in the immediate vicinity of electronic devices (e.g. ballasts), radio reception can be disturbed. Before installation at the assembly location, put the radio into operation and test it for interference. In case of interference, increase the distance to the source of interference.
- ⓘ When using an antenna wire as an external antenna, make sure that the wire and the tip of the antenna are insulated against 230 V.

### Assembling the device (Figure 1)

The inserts are connected.

- Insert the inserts (Figures 1, 4 and 5) correctly into the wall boxes and fasten them with the screws provided.
- Place the 2-gang frame (Figure 1, 1) over the inserts and attach the Radio Touch application module (Figure 1, 2) and the loudspeaker centre plate (Figure 1, 3).
- ⓘ Carefully guide the contact pins on the radio application module into the socket (Figure 5, 16) on the insert without bending them.
- ⓘ Assemble the Radio Touch and loudspeaker separately with two 1-gang frames or in combinations.

## 5.2 Radio start-up

The radio is assembled.

- Switch the operating voltage on.  
The display shows **Enter Time/Date!** and **back**.
- Press the **Enter Time/Date!** control panel.  
The control panels **Automatic**, **Manual** and **Time Zone** appear.
- Press **Automatic**.  
The time and date are set automatically as soon as a station with RDS reception is saved (see setting FM station with automatic search).
- ⓘ If no RDS signal is received, **Manual** must be selected (see Setting time and date manually).
- ⓘ When using 2 loudspeakers, both loudspeakers should be activated under **Setup, Sound**.
- ⓘ When using an antenna, the external antenna must be activated under **Setup, FM Antenna**.

## 6 Appendix



The device is at the end of its serviceable life never throw it away in the household waste under any circumstances. The local authorities provide information about environmentally-friendly disposal.

When used as intended, this device complies with the requirements of the R&TTE Directive (1999/5/EC). A complete declaration of conformity can be found on the Internet at [www.berker.com](http://www.berker.com).

### 6.1 Technical Data

#### Radio Touch

Operating voltage	230 V~, 50/60 Hz
Rated current	0.2 A
Power consumption at rated output power	7 W
Stand-by operation	1.3 W
Music rated power output (sine) per channel	1.5 W
Loudspeaker impedance	4 ... 8 Ω/channel
Input impedance <b>AUX IN</b>	10 kΩ
Frequency range FM	87.5 ... 108 MHz
Operating temperature	5 ... 40 °C
Protection class	II
Protection type	IP20
Connecting terminal	Screw terminals
Mains connection	2.5 mm <sup>2</sup>
Loudspeaker/AUX	1 mm <sup>2</sup>
Cable lengths:	
Loudspeaker	max. 20 m
<b>AUX IN</b>	max. 3 m
Extension units	max. 50 m
Installation depth	33 mm

#### Loudspeaker

Loudspeaker impedance	8 Ω
Sine output/music output	4/8 W
Frequency range	170 Hz ... 20 kHz
Prefabricated cable length	approx. 30 cm

### 6.2 Accessories

Loudspeaker	2882 xx xx
Docking station	2883 xx xx
USB/3.5 mm Audio socket outlet	33 1539 xx xx
3 x Cinch/S-video socket outlet	33 1532 xx xx

 Switches, controllers and timers are suitable as extension units. The same phase should be used as for the radio.

### 6.3 Troubleshooting

#### Poor FM radio reception

Cause 1: Internal FM antenna insufficient for reception.

Connection an additional antenna (Figure 5, 15).

Cause 2: Stereo playback is selected.

Switch to Mono.

---

**Poor audio signal during operation in an external audio device**

Cause 1: An insufficiently shielded cable was used for the connection.

Replace the connecting cable for the external audio device.

Cause 2: Shield of the cable is not connected correctly to the  $\perp$  terminal of the **AUX IN** connection.

Check the connection of the shield and rectify if necessary.

## **6.4 Warranty**

We reserve the right to make technical and formal changes to the product in the interest of technical progress.

Our products are under guarantee within the scope of the statutory regulations.

If you have a warranty claim, please contact the point of sale or ship the device postage free with a description of the appropriate regional representative.

**Berker GmbH & Co. KG**

Klagebach 38

58579 Schalksmühle/Germany

Phone: + 49 (0) 23 55/90 5-0

Fax: + 49 (0) 23 55/90 5-111

[www.berker.com](http://www.berker.com)