



















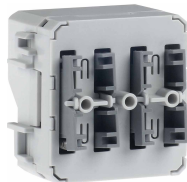

- ▲  Manufacture
- ▲  Berker
- ▲  Push button
  -  1gang KNX push-button
  -  2gang KNX push-button
  -  1gang KNX group push-button
  -  1gang KNX group push-button

## Application description

1gang KNX push-button module with integrated BAU  
 2gang KNX push-button module with integrated BAU  
 1gang KNX group push-button module with integrated BAU  
 2gang KNX group push-button module with integrated BAU



|   | Order number | Product designation   | Application programme   | TP product <br>Radio product  |
|---|--------------|---|---|---|
|  | 8014 12 00   | 1gang push-button module with integrated bus application unit       | S80141xx00<br>V1.0.0<br> |    |
|  | 8014 14 00   | 2gang push-button module with integrated bus application unit       | S80141xx00<br>V1.0.0<br> |    |
|  | 8014 13 00   | 1gang group push-button module with integrated bus application unit | S80141xx00<br>V1.0.0<br> |    |
|  | 8014 15 00   | 1gang group push-button module with integrated bus application unit | S80141xx00<br>V1.0.0<br> |    |

## Table of contents

|   |           |
|---|-----------|
| <b>1. General</b> .....   | <b>4</b>  |
| 1.1 General information about this application description .....  | 4         |
| 1.2 ETS Programming software .....  | 4         |
| 1.2.1 ETS Application designation  ..... | 4         |
| 1.3 Commissioning .....   | 5         |
| 1.3.1 Physical address .....  | 5         |
| 1.3.2 Application programme .....   | 5         |
| <b>2. Functional and device description</b> .....   | <b>6</b>  |
| 2.1 Device overview .....   | 6         |
| 2.2 Functional description .....  | 7         |
| 2.2.1 Operating concept.....  | 7         |
| 2.2.2 Range of functions .....  | 8         |
| 2.3 Functional overview .....   | 9         |
| <b>3. General, "Parameters"</b> .....   | <b>10</b> |
| 3.1 Blocking function .....   | 11        |
| 3.2 Parameter „Using mode“ .....  | 12        |
| 3.3 "Status LED brightness" parameter .....   | 13        |
| 3.3.1 General .....   | 13        |
| 3.3.2 Status LED .....  | 13        |
| <b>4. "Independent push-button"/"rocker" configuration</b> .....  | <b>15</b> |
| 4.1 General information .....   | 15        |
| 4.1.1 Individual push-button using mode .....   | 15        |
| 4.1.2 Rocker using mode .....   | 16        |
| 4.2 "Toggle switch" function .....  | 17        |
| 4.3 "ON/OFF" function .....   | 18        |
| 4.4 "Dimming" Function .....  | 19        |
| 4.5 "Shutter/blind" function.....   | 21        |
| 4.5.1 Hager/Berker behaviour.....   | 21        |
| 4.5.2 "Short – Long – Short" operating concept.....   | 23        |
| 4.5.3 "Long – Short" operating concept .....  | 25        |
| 4.5.4 "Short – Long" operating concept .....  | 27        |
| 4.5.5 "Long – Short or Short" operating concept .....   | 29        |

|           |   |           |
|-----------|---|-----------|
| 4.6       | "Value 1 bytes" function .....                              | 32        |
| 4.7       | "Value 2 bytes" function .....                              | 33        |
| 4.8       | Function "Room thermostat extension unit .....              | 34        |
| 4.9       | "Priority" function.....                                    | 37        |
| 4.10      | "Scene" function.....                                       | 39        |
| 4.11      | "Deactivate automatic functions" function .....             | 42        |
| <b>5.</b> | <b>"Information" parameter window .....</b>                 | <b>43</b> |
| <b>6.</b> | <b>Communication objects .....</b>                          | <b>44</b> |
| 6.1       | "General" communication objects .....                       | 44        |
| 6.1.1     | Blocking function.....                                      | 44        |
| 6.2       | Status LED communication objects .....                      | 44        |
| 6.2.1     | "Direction LED ON/OFF" brightness .....                     | 44        |
| 6.2.2     | Change of brightness value through object .....             | 44        |
| 6.3       | "Independent push-button/rocker" communication objects..... | 45        |
| 6.3.1     | Toggle switch .....   | 45        |
| 6.3.2     | Switching.....  | 46        |
| 6.3.3     | Dimming.....  | 47        |
| 6.3.4     | Shutter/blind.....  | 49        |
| 6.3.5     | Value 1 bytes .....   | 50        |
| 6.3.6     | Value 2 bytes .....   | 51        |
| 6.3.7     | Thermostat extension .....                                  | 52        |
| 6.3.8     | Mandatory control .....                                     | 53        |
| 6.3.9     | Scene.....  | 54        |
| 6.3.10    | Deactivate automatic .....                                  | 55        |
| <b>7.</b> | <b>Appendix.....</b>  | <b>56</b> |
| 7.1       | ETS software characteristics .....                          | 56        |
| 7.2       | Technical data .....  | 56        |
| 7.3       | Accessories.....  | 56        |
| 7.4       | Warranty.....   | 56        |
| <b>8.</b> | <b>Table of Figures.....</b>                                | <b>57</b> |
| <b>9.</b> | <b>List of tables.....</b>                                  | <b>59</b> |

## 1. General

### 1.1 General information about this application description

This document describes the operation and parameterisation of KNX devices with the aid of the Engineering Tool Software ETS.

The devices are parameterised by the ETS and the required settings are made during the first installation.

### 1.2 ETS Programming software

The application programmes are compatible with ETS5 or ETS4 and are always available in their latest version on our Internet website.

| ETS version               | File extension of compatible products | File extension of compatible projects |
|---------------------------|---------------------------------------|---------------------------------------|
| ETS 4 (v 4.18 and higher) | *.knxprod or *.vd5                    | *.knxproj                             |
| ETS 5 (v 5.04 and higher) | *.knxprod                             | *.knxproj                             |

Table1: ETS Software version

#### 1.2.1 ETS Application designation

| Application      | Article order number   |
|------------------|--|
| S80141xxx V1.0.0 | 1gang push-button module with integrated bus application unit (80141200)       |
| S80141xxx V1.0.0 | 2gang push-button module with integrated bus application unit (80141400)       |
| S80141xxx V1.0.0 | 2gang group push-button module with integrated bus application unit (80141300) |
| S80141xxx V1.0.0 | 2gang group push-button module with integrated bus application unit (80141500) |

Table2: ETS Application designations

## 1.3 Commissioning

The commissioning of the push-button/group push-button modules primarily refers to the programming of the physical address and the application data by the ETS Engineering Tool Software.

### 1.3.1 Physical address

The ETS assigns the physical address. The device has an integrated bus application unit for assigning the physical address; this application unit is fitted with a programming button and a red programming LED.

The red programming LED lights up by pressing the programming button. After assignment of the physical address by the ETS, the programming LED goes out.

To check whether the bus voltage is present, press the programming button briefly, the red LED lights up. Press the button once again to exit the programming mode.

#### Example:

- Activate programming mode      Actuate the programming button on the rear side of the push-button module.  
Programming LED flashes red.
- The ETS starts downloading the physical address.  
The programming mode is automatically cancelled once the download is complete → The programming LED is switched off.
- Label bus application unit with the physical address.

**i** If a device in an existing system is to be programmed, only one device can be in programming mode.

### 1.3.2 Application programme

The application software can be loaded on to the application unit directly when assigning the physical address, for example. If this has not taken place, it can also be programmed at a later date.

The application programme is downloaded directly on to the bus application unit of the push-button module.

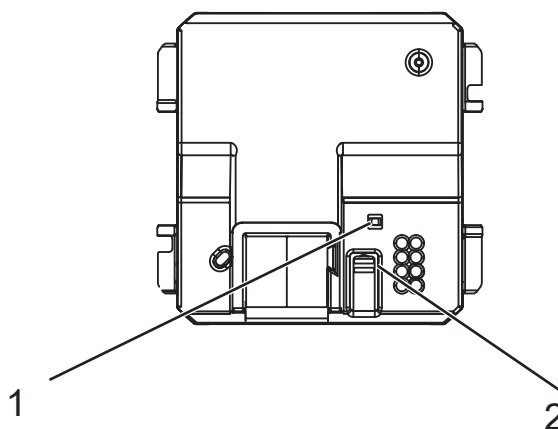

Figure 1: Push-button module

- (1) Programming LED
- (2) Programming button

## 2. Functional and device description

### 2.1 Device overview

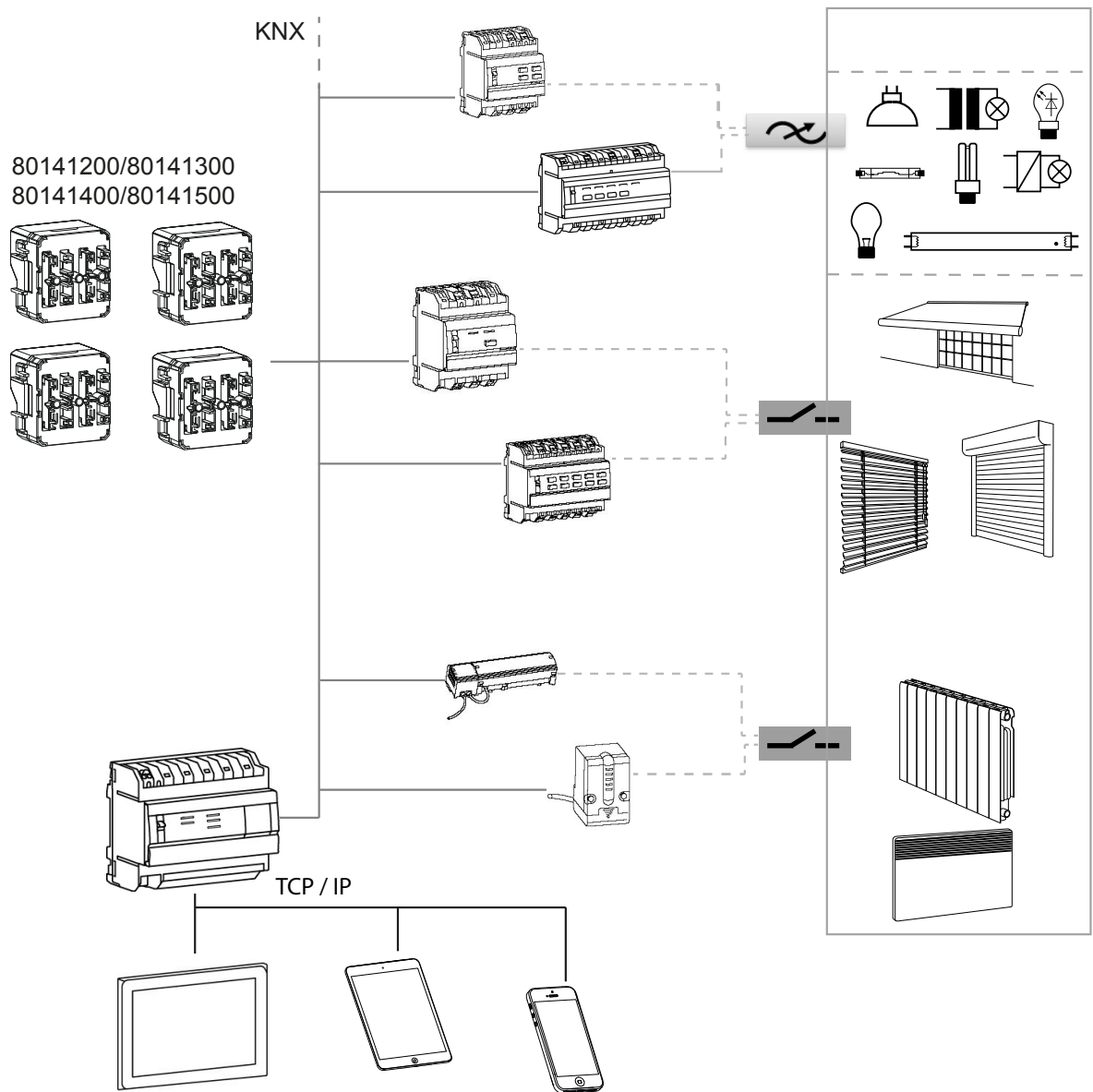

Figure 2: Device overview

## 2.2 Functional description

The 1gang and 2gang push button/group push button modules are monoblock devices with integrated bus application units. The rockers/buttons can be assigned the following functions: ON/OFF, dimming, shutter/blind, light scene activation, value, priority and thermostat extension. The assignment of the various functions is freely selectable for each rocker/button and is defined by parameterisation in the ETS. Depending on the parameterised functions, telegrams that trigger ON/OFF, dimming, blind/shutter functions, call up or save light scenes and set dimming, brightness or temperature values in the corresponding actuators are transmitted to the KNX system bus when rockers/buttons are pressed.

The following functions are formulated for the terms "rocker" and "individual push-buttons" for the devices listed.

### 2.2.1 Operating concept

The function of the individual control rockers depends on the type and programming of the push-button module.

#### Xgang push-button module:

The push-button module can be operated with a 1gang rocker (Figure 3, left) or with a 2gang rocker (Figure 3, right). The device on the left side has only one actuation point (Figure 3, 1) and the device on the right side has two actuation points (Figure 3, 1-2).

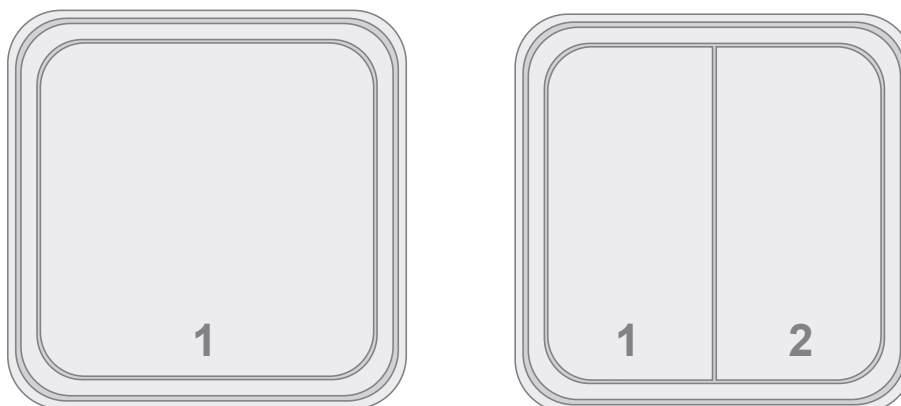

Figure 3: "Xgang push-button module" distribution

#### Xgang group push-button module:

The group push-button module can be operated with a 1gang rocker (Figure 4, left) or with a 2gang rocker (Figure 4, right). Due to the center position of the rockers, the device on the left side has two actuation points (Figure 4, 1-2) and the device on the right side has four actuation points (Figure 4, 1-4).

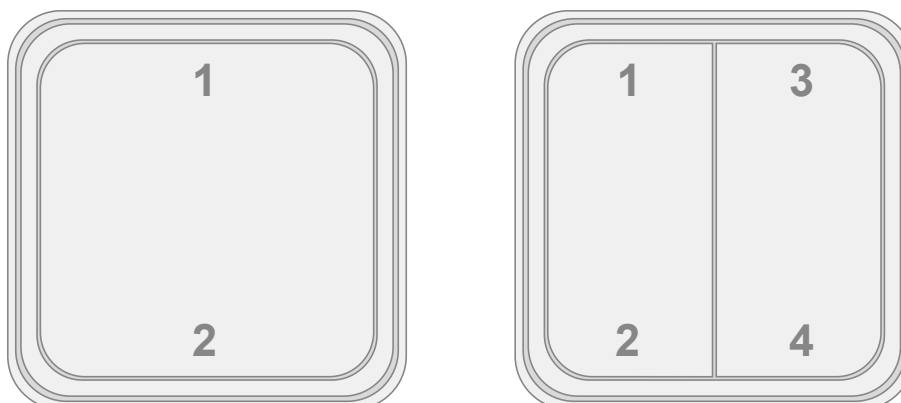

Figure 4: "Xgang group push-button module" distribution

## Operating instructions

The device differentiates between short and long touches.

- Short touch operation
  - Switch lighting
  - Shutter/blind step operation
  - Operating mode changeover, etc.
- Long touch operation
  - Dimming the lighting
  - Move command (move) roller shutter/blind
  - Saving of a scene

### 2.2.2 Range of functions

- Button surfaces can be configured as either a rocker or as independent buttons.
- Each rocker or independent button can be used for the following functions: switching, dimming, shutter/blind control, 1-byte value transmitter, 2-byte value transmitter, scene extension unit, and room thermostat extension unit.
- ON/OFF function: the following settings are possible for each button: response when the rocker/button is pressed and/or released, switching on, switching off, not active.
- The following adjustments are possible when dimming: times for short and long touches, dimming in different steps, transmitting a stop telegram at the end of the touch, transmitting dimming values.
- The following adjustments are possible during blind control: up/down, position (slat position / shutter/blind position), safety run
- The following settings are possible in the 1-byte and 2-byte value transmitter function: selection of the value range (0-100 %, 0-65535, 0-1500 Lux, 0-40°C), value when pressed.
- The following settings are possible in the scene function: call-up of a scene number (1-64), saving upon long key-press and emission time delay.
- When the button is being used as a control extension, the following adjustments are possible: operating mode change-over, heating/cooling change-over.



## 2.3 Functional overview

The functions described in the following section enable the individual configuration of the device inputs or outputs.

### Not active

The "Not active" function means that no function is assigned to the rocker/button; the rocker/button is disabled.

### Toggle switch

The "Toggle switch" function switches on the lighting upon the first key-press and switches it off again upon the second.

### Switching

The "ON/OFF" function enables the push-button (lighting circuits, for example) to be switched on or off (ON, OFF, ON/OFF, for example).

### Dimming

The "Dimming" function enables the push-button to increase and decrease the dimming in lighting circuits.

This function can either be used as a rocker or as a button (first key-press dims up, second dims down (during toggle mode)).

 The rockers/buttons function can only be selected in the group push-button modules.

### Shutter/blind

The "Shutter/blind" function allows blinds, shutters, awnings or similar hangings to be opened and closed.

This function can either be used as a rocker or as a button (first key-press moves blind UP, second key-press moves blind DOWN (during toggle mode)).

 The rockers/buttons function can only be selected in the group push-button modules.

### Value 1 byte/2 bytes

The value transmitter (1 byte) function allows values from 0 to 100 % to be transmitted to a dim actuator, for example.

The value transmitter (2 bytes) function allows values from 0 to 65535, brightness values from 0 to 1000 lx or temperature values from 0 to 40°C to be configured.

### Thermostat extension

When being used as a control extension, the following parameter settings can be set/selected for each button or rocker. Override setpoint to a defined operating mode, setpoint selection or heating/cooling changeover

### Mandatory control

The "Priority" function enables a precisely defined state (2 bits) to be specified or enables the function to impose a defined state.

### Scene

When functioning as a scene extension, a light scene can be called up in a KNX device.

### Deactivate automatic

This function can be used to interrupt and deactivate ongoing operations (time-controlled lighting).

 This function must be configured in our TXA... and TYA... actuators.

### 3. General, "Parameters"

The following sections describe the configuration of the parameters for the devices 1gang/2gang push-button module and group push-button module with bus application unit. The functions of the different modules only differ in the number of channels/buttons.

**i** ETS Engineering Tool Software (version ETS4.x / ETS5.x) is used for parameterisation and commissioning.

Global parameter settings for the entire device (i.e. for all buttons/rockers) are made under "General".

Tasten/Wippen eingestellt.

An image is displayed for the selected device under the operating concept which depicts the press-activation points of the rocker(s)/button(s) relevant to the selected device.

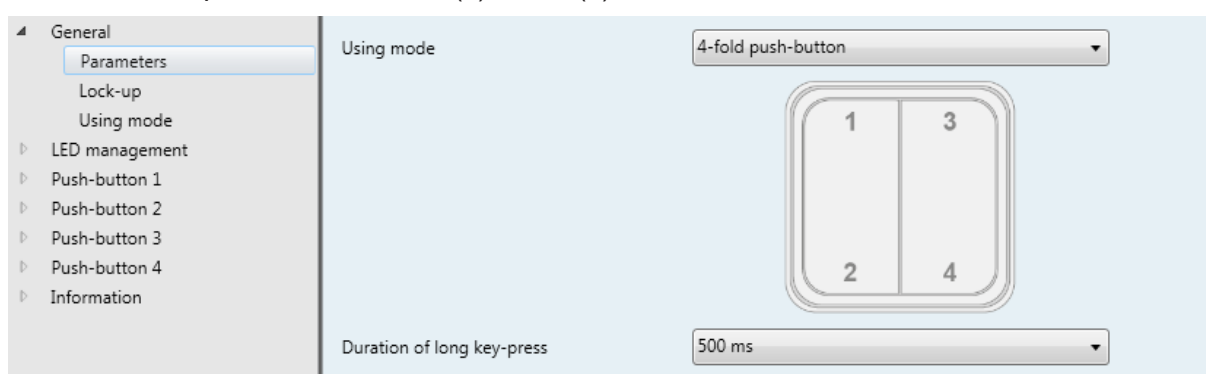

Figure 5: General, "Parameters"

| Parameters                                       | Description  | Value  |
|--|--|--|
| Operating concept                                | This parameter selects the device used.  | 1gang <b>rocker*</b><br>2gang rocker<br>1gang push-button<br>2gang push-button |
| Time for long key-press (dimming, shutter/blind) | This parameter defines the moment from when a long push-button action is detected. | 400 ms - <b>500 ms*</b> ... 1 s  |

Table3: General, "Parameters"

\* Default value

### 3.1 Blocking function

In the following parameter window, the respective functions and selection options of the **Lock-up function** for the operating concept are displayed and configured as **rocker** and **button**.

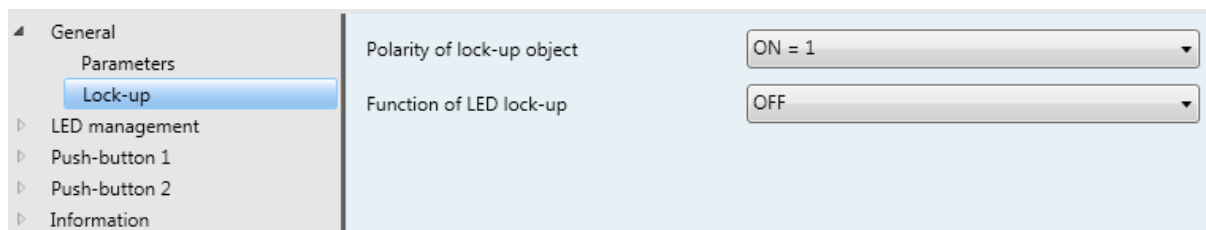

Figure 6: General "Lock-up"

| Parameters                 | Description  | Value                    |
|----------------------------|--|--------------------------|
| Polarity of lock-up object | This parameter defines at which value the blocking function is activated.  | <b>ON = 1*</b><br>ON = 0 |
| Function of LED lock-up    | The function of the status LED for the respective button is set with this parameter if the disabling function is active. | <b>Off*</b><br>Blinking  |

Table4: General "Lock-up"

| No. | Name    | Object function   | Length | Data type        |
|-----|---------|-------------------|--------|------------------|
| 4   | General | Blocking function | 1 bits | 1.011 DPT_Status |

The device has a lock-up function that can be used to lock independent buttons or rockers. To activate the lock-up function for each button/rocker, the **Lock-up function** must be explicitly activated (ticked) in the "Function" parameter branch for each button/rocker.

After bus voltage recovery, a lock-up remains active if it was activated before the bus voltage failed. The lock-up is always deactivated after a programming process by the ETS.

The polarity of the lock-up object can be parameterised.

If the polarity of the lock-up object is set to "Inverted (ON = 0)", the push-button is not immediately locked in the event of bus voltage recovery or after a download if no lock-up was switched on before the bus voltage failed. In such cases, the lock-up is only activated in the event of an object update (value = "0") for the lock-up object!

\* Default value

### 3.2 Parameter „Using mode“

This function only becomes visible when the 1gang push-button or 2gang push-button selection is made under General – Parameters – Operating concept. You can select between the operating concept as a single button or as a rocker for both of these device variants.

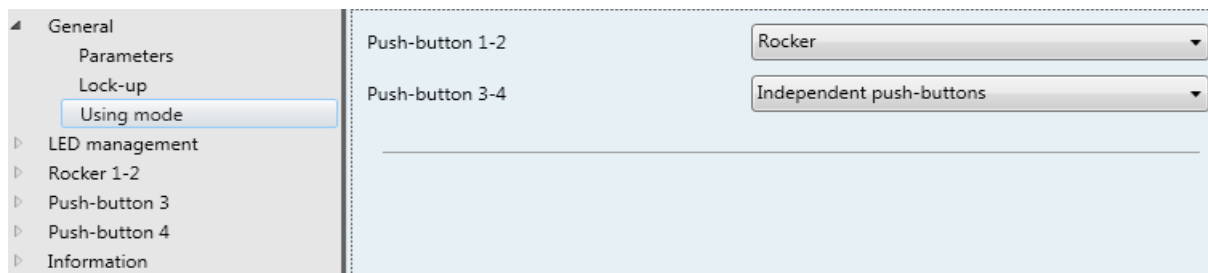

Figure 7: Parameter „Using mode“

The button pair can be operated in the "independent push-button" function; i.e. each individual independent button can be assigned an individual function (for example, top side of the rocker (button 1) for light ON/OFF, bottom side of the rocker (button 2) for blind UP/DOWN).

The button pair can also be operated in the "rocker" function; i.e. the rocker pair work together to carry out a joint function (for example, top rocker side for light ON, bottom rocker side for light OFF).

| Parameters      | Description   | Value                                       |
|-----------------|---|---|
| Push-button 1-2 | This parameter can be used to configure the function of the buttons/rocker. | <b>Independent push-buttons *</b><br>Rocker |
| Buttons 3–4 **  | This parameter can be used to configure the function of the buttons/rocker. | <b>Independent push-buttons *</b><br>Rocker |

Table5: Parameter „Using mode“

\*\* This parameter is only visible when the 2gang push-button device is selected under General – Parameters.

\* Default value

### 3.3 "Status LED brightness" parameter

#### 3.3.1 General

The **status LED brightness** is configured and described in the following parameter window. The colour of the status LED is fixed with the colour red.

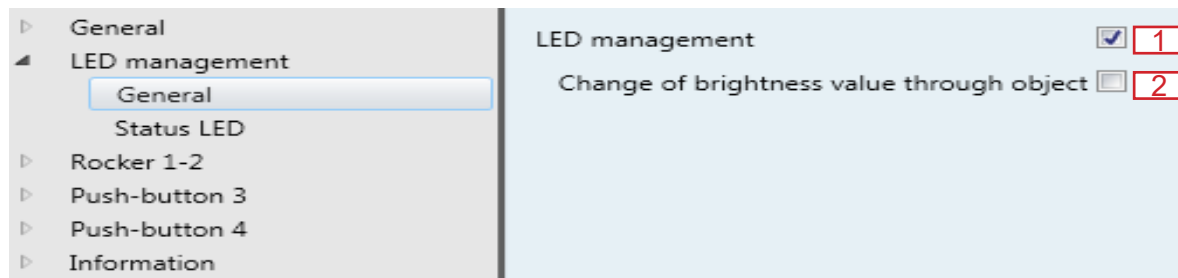

Figure 8: Status LED brightness, "General"

The tick box (Figure 8, 1) must be activated in order to adjust the settings for the status LED brightness. The brightness value for both the status LED and the direction LED can also be changed separately for day and night using separate communication objects. (Figure 8, 2).

When "Status LED brightness" is activated, another parameter for configuring the status LED opens.

#### 3.3.2 Status LED

Each rocker is fitted with one RGB status LED that can be connected internally to the operating function depending on the function of the rocker or button.

**i** If parameterised as an independent push-button, the status LED is assigned to the upper button.

##### 1-fold push-button module (independent push-button):

- Button 1 status LED
- Button 2 → no LED function

##### 2-fold push-button module (independent push-button):

- Button 1 status LED
- Button 2 → no LED function
- Button 3 status LED
- Button 4 → no LED function

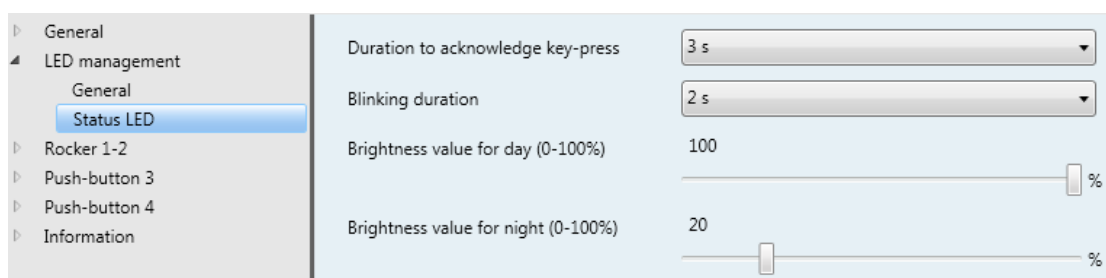

Figure 9: Brightness of the "Status LED" status LED

| Parameters                           | Description   | Value                        |
|--------------------------------------|---|------------------------------|
| Duration to acknowledge key-press    | With this parameter the lighting duration of the status LED upon pressing the button/rocker is set. | 0.5 s... <b>3 s*</b> ... 5 s |
| Flashing duration                    | This parameter defines the blinking duration of the LED   | 250 ms - <b>2 s*</b> ... 5 s |
| Brightness value for day (0-100 %)   | The sidebar for this parameter can be used to set the brightness value for daytime operation.       | 0 ... <b>100%*</b>           |
| Brightness value for night (0-100 %) | The sliding bar for this parameter can be used to set the brightness value for nighttime operation. | 0 ... <b>20 %*</b> ... 100 % |

Table6: LED management, "Status LED"

| No. | Name           | Object function               | Length | Data type                      |
|-----|----------------|-------------------------------|--------|--------------------------------|
| 5   | LED management | Day/Night                     | 1 bits |                                |
| 6   | LED management | Device LED ON/OFF             | 1 bits | 1.001 DPT_ON/OFF               |
| 9   | LED management | Status LED – brightness day   | 1 byte | 5.001 DPT_Percentage (0-100 %) |
| 11  | LED management | Status LED – brightness night | 1 byte | 5.001 DPT_Percentage (0-100 %) |

\* Default value

## 4. "Independent push-button"/"rocker" configuration

### 4.1 General information

The following chapter describes the **rocker/independent push-button** configuration. Only the first rocker or the first pair of independent push-buttons are described. An additional rocker / additional independent push-buttons must be configured accordingly.

#### 4.1.1 Individual push-button using mode



Figure 10: Function type of the button(s)

| Parameters                              | Description  | Value  |
|---|--|--|
| Function of the independent push-button | This parameter defines the function type of the button(s). | <b>Not active *</b><br>Toggle switch<br>ON/OFF<br>Dimming<br>Shutter/blind<br>Value 1 byte<br>Value 2 bytes<br>Thermostat extension<br>Priority<br>Scene<br>Automatic control deactivation |
| LED status                              | This parameter defines the status LED function.            | <b>Always off *</b><br>Always on<br>Acknowledgement  |

Table7: "Button function type" parameters

- i** The lock-up function can be activated for the respective independent push-button (tick box, Figure 10 ,1).
- i** The LED status parameter can only be set for button 1 in this type of configuration.

\* Default value

### 4.1.2 Rocker using mode

If the device is an xgang group push-button module, two parameters for the rocker configuration become visible (function and status LED).

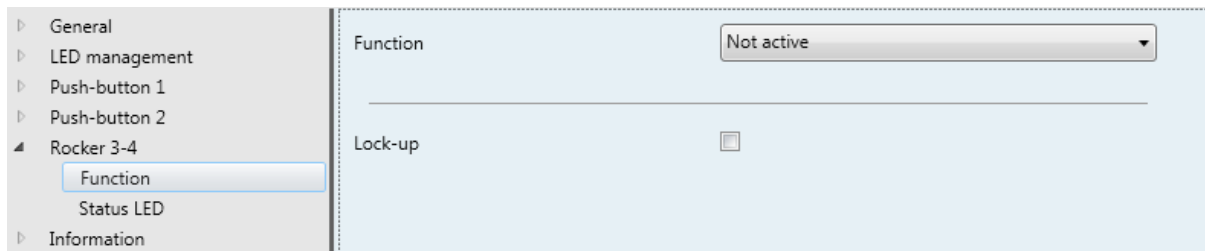

Figure 11: Function type of the rocker(s)

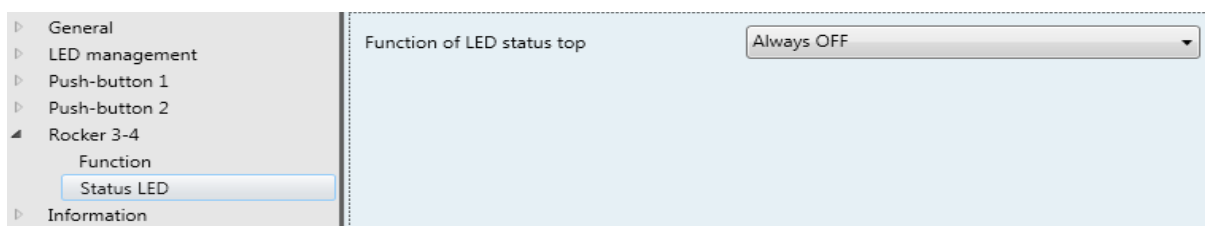



Figure 12: Status LED of the rocker(s)

| Parameters      | Description  | Value  |
|-----------------|--|--|
| Function rocker | This parameter defines the function type of the rocker(s). | <b>Not active *</b><br>Toggle switch<br>ON/OFF<br>Dimming<br>Shutter/blind<br>Value 1 byte<br>Value 2 bytes<br>Thermostat extension<br>Priority<br>Scene<br>Automatic control deactivation |
| LED status      | This parameter defines the status LED function.            | <b>Always off *</b><br>Always on<br>Acknowledgement  |

Table8: "Rocker function type" parameters

 The lock-up function can be activated for the respective rocker (tick boxBild 15 ,1).

\* Default value



## 4.2 "Toggle switch" function

The **Toggle switch** function for the push-button or rocker operating concept is configured in the parameter windows below (Figure 13).

The "Toggle switch" function means changing over. When the "Toggle switch" function is active, pressing the same push-button/rocker side triggers an alternate switching command.

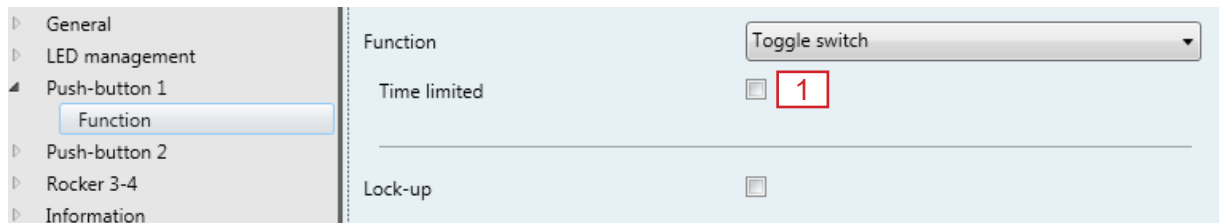

Figure 13: "Toggle switch" function of the push-button(s)

When the "Toggle switch" function is active in the rocker using mode, pressing the top or bottom rocker side triggers a switching command. In this parameterisation, no detailed settings are possible per rocker side.

"Toggle switch" function communication objects (rocker)

| No.     | Name       | Object function          | Length | Data type        |
|---------|------------|--------------------------|--------|------------------|
| 13, 53, | Rocker x-y | ON/OFF status indication | 1 bits | 1.001 DPT_ON/OFF |
| 18, 58, | Rocker x-y | Switching                | 1 bits | 1.001 DPT_ON/OFF |

"Toggle switch" function communication objects (button)

| No.                | Name     | Object function          | Length | Data type        |
|--------------------|----------|--------------------------|--------|------------------|
| 13, 33,<br>53, 73, | Button x | ON/OFF status indication | 1 bits | 1.001 DPT_ON/OFF |
| 18, 38,<br>58, 78, | Button x | Switching                | 1 bits | 1.001 DPT_ON/OFF |

### "Toggle switch" function – time limited

This function is available in both operating concepts if the tick box 1 in the Figure 13 is activated.

Pressing the button quickly changes the output state. The state changes each time a short key-press occurs. If the button is not pressed, the output is switched off after the time set in the output. Pressing the button for a long time retriggers the switch-off time.

Details:

when a short key-press occurs, the push-button transmits the reversal of the last command received on the status object via the on pulse object. When the button is pressed for a long time, the push-button transmits an ON command via the on pulse object.

An ON command on the on pulse object in our TXA products switches on the output for the time set.

An OFF command on the on pulse object switches off the output. If an ON command follows even though the output is still switched on, the switch-on time is restarted (retriggered). "Toggle switch" function communication objects (rocker)

### 4.3 "ON/OFF" function

The different function variants of the **Switching** function for the independent button (Figure 14) and rocker pair are presented and described in the parameter window below.

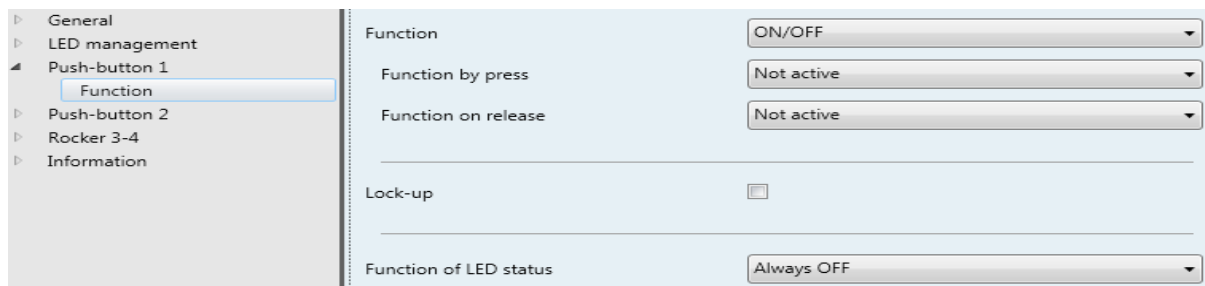

Figure 14: "Function by press/on release" parameters

**i** The independent button can trigger different responses for the two actuation functions PRESS/RELEASE.

| Parameters  | Description   | Value                                      |
|---|---|--|
| Function by press<br>Function on release"<br>(Individual push-button configuration) | This parameter defines the function of the button.                              | <b>Not active *</b><br>ON<br>OFF           |
| Function by press top<br>Function by press bottom<br>(Configuration rocker)         | This parameter defines the function of the rocker.                              | <b>Not active *</b><br>ON<br>OFF           |
| Emission time delay upon press<br>Emission time delay upon release                  | This parameter defines when the button command is to be transmitted to the bus. | <b>Immediate emission *</b><br>1 s - 5 min |

Table9: "Function by press/on release" ON/OFF parameters

#### "ON/OFF" function communication objects (rocker)

| No.     | Name       | Object function | Length | Data type        |
|---------|------------|-----------------|--------|------------------|
| 18, 58, | Rocker x-y | Switching       | 1 bits | 1.001 DPT_ON/OFF |

#### "ON/OFF" function communication objects (button)

| No.                | Name     | Object function | Length | Data type        |
|--------------------|----------|-----------------|--------|------------------|
| 18, 38,<br>58, 78, | Button x | Switching       | 1 bits | 1.001 DPT_ON/OFF |

\* Default value

## 4.4 "Dimming" Function

The **Dimming** function is described below. The lighting can be switched on/off (short press of button), and dimmed brighter and darker (long press of button) with the "Dimming" function.

When the operating surface is set as a rocker, two-push-button operation is preset for the dimming function. For example, this means that in the event of a short press of button 1, the device transmits a telegram to switch on and, in the event of a long press, a telegram to dim upward ("Brighter"). Respectively, in the event of a short press of button 2, it transmits a telegram to switch off and, in the event of a long press, a telegram to dim down ("Darker").

When the operating surface is set as a button, single-push-button operation is preset for the dimming function. Each time a short press of the respective button occurs, the push-button sends the telegram for the set function. In the event of a long press of the button, the device sends a telegram for the dimming command.

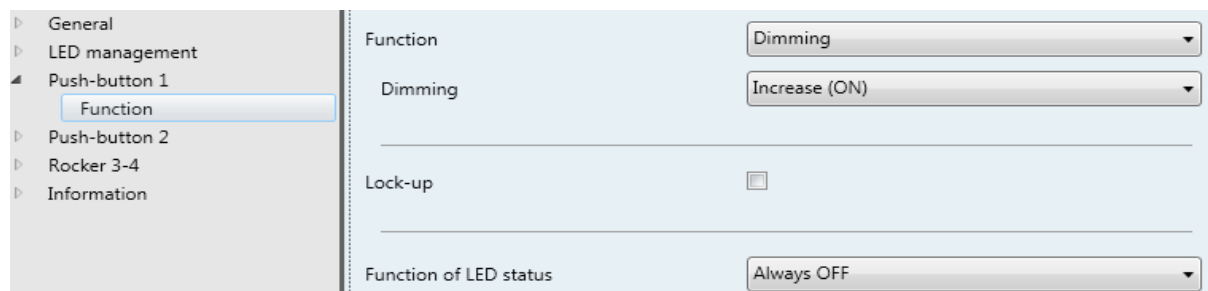

Figure 15: "Dimming" Function

| Parameters  | Description   | Value  |
|---|---|--|
| Function of the independent push-button "Dimming" | With this parameter the following function is assigned to the button in the "Dimming" function when pressing the button.  | <b>Increase (ON) *</b><br>Decrease (OFF)<br>Increase (toggle switch)<br>Decrease (toggle switch)<br>Increase/Decrease (toggle switch)<br>Dimming value |
| Function of the "Dimming" rocker                  | With this parameter the following function is assigned to the rocker in the "Dimming" function. A distinction is made here between the function when the rocker is pressed up and the function when the rocker is pressed down. | <b>Increase (ON) *</b><br>Decrease (OFF)<br>Increase (toggle switch)<br>Decrease (toggle switch)<br>Increase/Decrease (toggle switch)<br>Dimming value |

Table10: Rocker/button "Dimming" function

"Dimming (Increase/Decrease)" function communication objects (rocker)

| No.     | Name       | Object function | Length | Data type             |
|---------|------------|-----------------|--------|-----------------------|
| 18, 58, | Rocker x-y | Switching       | 1 bits | 1.001 DPT_ON/OFF      |
| 21, 61, | Rocker x-y | Dimming         | 4 bits | 3.007 DPT_Dimmer step |

\* Default value

"Dimming (Increase/Decrease)" function communication objects (button)

| No.                | Name     | Object function | Length | Data type             |
|--------------------|----------|-----------------|--------|-----------------------|
| 18, 38,<br>58, 78, | Button x | Switching       | 1 bits | 1.001 DPT_ON/OFF      |
| 21, 41,<br>61, 81  | Button x | Dimming         | 4 bits | 3.007 DPT_Dimmer step |

"Dimming (Increase/Decrease toggle switch)" function communication objects (rocker)

| No.     | Name       | Object function          | Length | Data type             |
|---------|------------|--------------------------|--------|-----------------------|
| 13, 53, | Rocker x-y | ON/OFF status indication | 1 bits | 1.001 DPT_ON/OFF      |
| 18, 58, | Rocker x-y | Switching                | 1 bits | 1.001 DPT_ON/OFF      |
| 21, 61, | Rocker x-y | Dimming                  | 4 bits | 3.007 DPT_Dimmer step |

"Dimming (Increase/Decrease toggle switch)" function communication objects (button)

| No.                | Name     | Object function          | Length | Data type             |
|--------------------|----------|--------------------------|--------|-----------------------|
| 13, 33,<br>53,73,  | Button x | ON/OFF status indication | 1 bits | 1.001 DPT_ON/OFF      |
| 18, 38,<br>58, 78, | Button x | Switching                | 1 bits | 1.001 DPT_ON/OFF      |
| 21, 41,<br>61, 81  | Button x | Dimming                  | 4 bits | 3.007 DPT_Dimmer step |

In addition to the dimming communication objects, the ON/OFF communication objects are also visible. Two separate group addresses for ON/OFF and dimming must be created and connected with the corresponding communication objects.

If the "Dimming – dimming value" function is selected, the dimming value is to be set by means of the slider (0 % ... 100 %). Only one communication object can be selected in this function. The "Dimming – dimming value" function assigns a specific brightness value to the lamp via the connected actuator. The scene values are primarily only set in the actuator. Scenes can only be called up or adjusted on the push-button.

## 4.5 "Shutter/blind" function

The **Shutter/blind** function for the button and rocker operating concept are configured in the parameter windows below.

This function switches shutters, blinds, awnings and other hangings. In the "Shutter/blind" function, a distinction is made between long and short key-presses.

- Short key-press: the device transmits a step or stop command to the bus via the Slat Step/Stop (step) communication object.
- Long key-press: The device transmits a motion command (Up/Down) to the bus via the Up/Down (move) communication object.

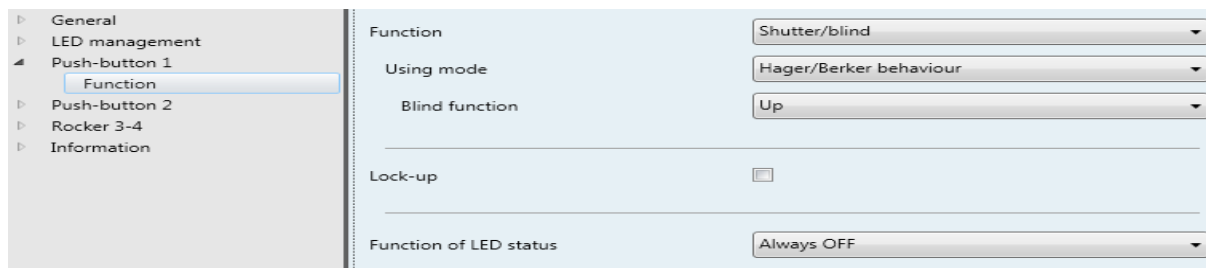

Figure 16: "Roller shutter/blind" function

In the rocker using mode, the "Shutter/blind" function can be set so that the top rocker side raises the shutter and the bottom side lowers it. The rocker sides work as part of the same function (they function in the same way as 2 shutter/blind buttons). Two communication objects (Rocker x-y Slat Step/Stop (step) and rocker x-y Up/Down (move)) are displayed for the respective function version.

### Operating concepts for the roller shutter / blind function

Five different operating concepts are available in the application for activating roller shutters, blinds or similar hangings. In these operating concepts, the telegrams are transmitted to the bus with a different time sequence. This allows the widest range of drive concepts to be set and operated.

| Parameters  | Description   | Value  |
|---|---|--|
| Using mode of the rocker(s)/ independent push-button(s) | This parameter selects the using mode of the "Shutter/blind" function | <b>Hager/Berker behaviour *</b><br>Short – Long – Short<br>Long – Short<br>Short – Long<br>Long – Short or Short |

Table11: "Shutter/blind" rocker/button using mode

\* Default value

#### 4.5.1 Hager/Berker behaviour

**i** The "Hager/Berker behaviour" has been adapted to the new Hager/Berker blind and roller shutter actuators.

| Parameters  | Description   | Value  |
|---|---|--|
| Function blind<br>(Individual push-button configuration)                              | In the sun protection type, this parameter selects the function of the independent push-buttons.  | <b>Up *</b><br>Down<br>Up/Down/Stop<br>Position (0-100 %)<br>Position/slat angle (0-100 %)<br>Slat angle (0-100 %) |
| Function upon press on top<br>Function upon press on bottom<br>(Configuration rocker) | In the sun protection type, this parameter selects the function of the top and bottom rocker side | <b>Up *</b><br>Down<br>Up/Down/Stop<br>Position (0-100 %)<br>Position/slat angle (0-100 %)<br>Slat angle (0-100 %) |

Table12: Hager/Berker behaviour parameters

| Parameters                       | Description  | Value                  |
|----------------------------------|--|------------------------|
| Position (0–100%) <sup>1,2</sup> | This parameter sets a specific shutter/blind position using the sidebar. | <b>0 % * ... 100 %</b> |
| Slat angle (0–100%) <sup>2</sup> | This parameter sets the slat angle of the slat using the sidebar.        | <b>0 % * ... 100 %</b> |

Table13: Blind, shutter and slat position parameters

<sup>1</sup> This parameter is not visible until the value "Position (0–100 %)" or "Position/Slat angle (0–100 %)" is selected in the "Function" parameter.

<sup>2</sup> This parameter is not visible until the value "Slat angle (0–100 %)" or "Position/Slat angle (0–100 %)" is selected in the "Function" parameter.

\* Default value

### 4.5.2 "Short – Long – Short" operating concept

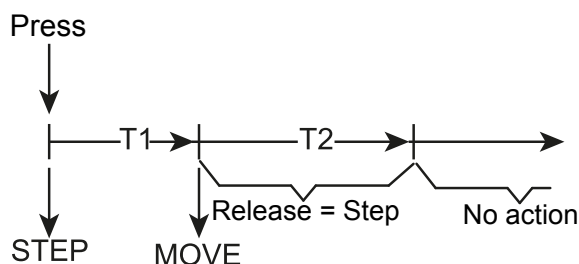

Figure 17: "Short – Long – Short" operating concept

As soon as the button is pressed, the device transmits a step telegram to the bus. As a result, a moving drive is stopped and the time T1 ("the time between a step and move command") is started. If the button is released again within T1, no further telegram is transmitted. This step stops an ongoing continuous move.

**i** The "time between a step and move command" in the device should be set shorter than the step operation of the actuator so that no disturbing buckling of the blind occurs.

If the button is kept pressed for longer than T1, the push-button transmits a move telegram for extending the drive after T1 has expired and the time T2 ("slat adjusting time") is started.

If the button is released within the slat adjusting time, the device transmits another short-time telegram. This function is used for the slat adjustment of a blind. As a result, the slats can be stopped at any position within their rotation. The length of the "slat adjusting time" selected should be as long as the time required by the drive to turn the slats completely. If the "slat adjusting time" selected is longer than the complete operation time of the drive, a touch function is also possible. The driver only moves if the button is pressed down.

If the button is pressed down longer than T2, the device does not transmit any further telegram. The drive continues moving until the end position is reached.

Times T1 ("time between a step and move command") and T2 ("slat adjusting time") must first be adjusted.

| Parameters                               | Description                                    | Value                              |
|--|--|------------------------------------|
| Duration between short-long key-press T1 | T1 is the time between a step and move command | 1 ... <b>4</b> *... 3000 (x100 ms) |
| Duration of the slat angle setting T2    | T2 is the slat adjusting time.                 | 1 ... <b>5</b> *... 3000 (x100 ms) |

Table14: Time setting under "Short – Long – Short"

\* Default value

| Parameters  | Description   | Value  |
|---|---|--|
| Function blind<br>(Individual push-button configuration)                              | In the sun protection type, this parameter selects the function of the independent push-buttons.                                | <b>Up *</b><br>Down<br>Position (0-100 %)<br>Position/slat angle (0-100 %)<br>Slat angle (0-100 %) |
| Function upon press on top<br>Function upon press on bottom<br>(Configuration rocker) | In the sun protection type, this parameter selects the function of the top and bottom rocker side                               | <b>Up *</b><br>Down<br>Position (0-100 %)<br>Position/slat angle (0-100 %)<br>Slat angle (0-100 %) |
| Position (0-100 %) <sup>1,2</sup>   | This parameter allows the shutter/ blind to reach a specific position by pressing a button. The value is set using the sidebar. | <b>0 % * ... 100 %</b>   |
| Slat angle (0-100 %) <sup>2</sup>   | This parameter allows a specific blind slat angle to be set by pressing a button. The value is set using the sidebar.           | <b>0 % * ... 100 %</b>   |

Table15: Blind, shutter and slat position parameters

<sup>1</sup> This parameter is only visible when the value "Position (0-100 %)" or "Position/slat angle (0-100 %)" is selected in the "Function when pressing the rocker side/independent push-button" parameter.

<sup>2</sup> This parameter is only visible when the value "Slat angle (0-100 %)" or "Position/slat angle (0-100 %)" is selected in the "Function when pressing the rocker side/independent push-button".

\* Default value



### 4.5.3 "Long – Short" operating concept

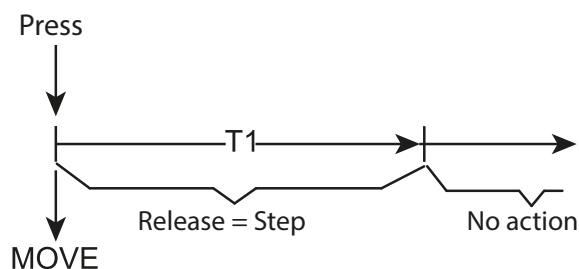

Figure 18: "Long – Short" operating concept

Immediately upon pressing the button, the device transmits a long-time telegram (Move). As a result, the drive starts moving and time T1 ("slat adjusting time") is started.

If the button is released during the slat adjusting time, the device transmits a step telegram. This function is used for the slat adjustment of a blind. As a result, the slats can be stopped at any position within their rotation. The length of the "slat adjusting time" selected should be as long as the time required by the drive to turn the slats completely. If the "slat adjusting time" selected is longer than the complete operation time of the drive, a touch function is also possible. The driver only moves if the button is pressed down.

If the button is pressed down longer than T1, the device does not transmit any further telegram. The drive continues moving until the end position is reached.

Time T1 ("time between a step and move command") must first be adjusted.

| Parameters                               | Description                                    | Value                       |
|--|--|-----------------------------|
| Duration between short-long key-press T1 | T1 is the time between a step and move command | 1 ... 4 *... 3000 (x100 ms) |

Table16: Time setting under "Long – Short"

\* Default value

| Parameters  | Description  | Value  |
|---|--|--|
| Function blind<br>(Individual push-button configuration)                              | In the sun protection type, this parameter selects the function of the independent push-buttons.                                 | <b>Up *</b><br>Down<br>Up/Down/Stop<br>Position (0-100 %)<br>Position/slat angle (0-100 %)<br>Slat angle (0-100 %) |
| Function upon press on top<br>Function upon press on bottom<br>(Configuration rocker) | In the sun protection type, this parameter selects the function of the top and bottom rocker side                                | <b>Up *</b><br>Down<br>Up/Down/Stop<br>Position (0-100 %)<br>Position/slat angle (0-100 %)<br>Slat angle (0-100 %) |
| Position (0-100 %) <sup>1</sup>   | This parameter allows the shutter/ blind to reach a specific position by pressing a button. The value is set using the slidebar. | <b>0 % * ... 100 %</b>   |
| Slat angle (0-100 %) <sup>2</sup>   | This parameter allows a specific blind slat angle to be set by pressing a button. The value is set using the slidebar.           | <b>0 % * ... 100 %</b>   |

Table17: Blind, shutter and slat position parameters

<sup>1</sup> This parameter is only visible when the value "Position (0-100 %)" or "Position/slat angle (0-100 %)" is selected in the "Function when pressing the rocker side/independent push-button" parameter.

<sup>2</sup> This parameter is only visible when the value "Slat angle (0-100 %)" or "Position/slat angle (0-100 %)" is selected in the "Function when pressing the rocker side/independent push-button".

\* Default value

#### 4.5.4 "Short – Long" operating concept

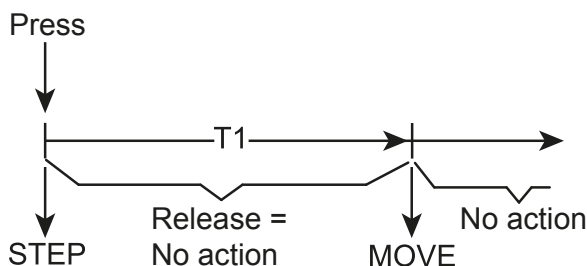

Figure 19: "Short – Long" using mode

Immediately upon pressing the button, the device transmits a short-time telegram. As a result, a moving drive is stopped and the time T1 ("the time between a step and move command") is started. If the button is released again within T1, no further telegram is transmitted. This step stops an ongoing continuous move. The "time between a step and move command" in the push-button should be set shorter than the step operation of the actuator so that no disturbing buckling of the blind occurs.

If the button is kept pressed longer than T1, the push-button transmits a long-time telegram for extending the driver after T1 has expired.

When the button is released, the push-button does not transmit any further telegram. The drive continues moving until the end position is reached.

Times T1 ("time between a step and move command") and T2 ("slat adjusting time") must first be adjusted.

| Parameters                               | Description                                    | Value                       |
|--|--|-----------------------------|
| Duration between short-long key-press T1 | T1 is the time between a step and move command | 1 ... 4 *... 3000 (x100 ms) |

Table18: Time setting under "Short – Long"

\* Default value

| Parameters  | Description  | Value  |
|---|--|--|
| Function blind<br>(Individual push-button configuration)                              | In the sun protection type, this parameter selects the function of the independent push-buttons.                                 | <b>Up *</b><br>Down<br>Up/Down/Stop<br>Position (0-100 %)<br>Position/slat angle (0-100 %)<br>Slat angle (0-100 %) |
| Function upon press on top<br>Function upon press on bottom<br>(Configuration rocker) | In the sun protection type, this parameter selects the function of the top and bottom rocker side                                | <b>Up *</b><br>Down<br>Up/Down/Stop<br>Position (0-100 %)<br>Position/slat angle (0-100 %)<br>Slat angle (0-100 %) |
| Position (0-100 %) <sup>1</sup>   | This parameter allows the shutter/ blind to reach a specific position by pressing a button. The value is set using the slidebar. | <b>0 % * ... 100 %</b>   |
| Slat angle (0-100 %) <sup>2</sup>   | This parameter allows a specific blind slat angle to be set by pressing a button. The value is set using the slidebar.           | <b>0 % * ... 100 %</b>   |

Table19: Blind, shutter and slat position parameters

<sup>1</sup> This parameter is only visible when the value "Position (0-100 %)" or "Position/slat angle (0-100 %)" is selected in the "Function when pressing the rocker side/independent push-button" parameter.

<sup>2</sup> This parameter is only visible when the value "Slat angle (0-100 %)" or "Position/slat angle (0-100 %)" is selected in the "Function when pressing the rocker side/independent push-button".

\* Default value

### 4.5.5 "Long – Short or Short" operating concept

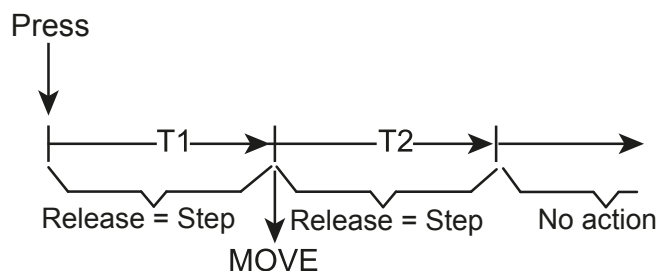

Figure 20: "Long – Short or Short" operating concept

As soon as the button is pressed, the device starts the time T1 ("time between a step and move command") and waits. If the button is released again before T1 expires, the device transmits a step telegram. In this way, a moving drive can be stopped. A stationary drive turns the slats by one step.

If the button remains pressed after T1 has expired, the device transmits a move telegram and starts the time T2 ("slat adjusting time").

If the button is released within T2, the device transmits a short-time telegram. This function is used for the slat adjustment of a blind. As a result, the slats can be stopped at any position within their rotation. The length of the "slat adjusting time" selected should be as long as the time required by the drive to turn the slats completely. If the "slat adjusting time" selected is longer than the complete operation time of the drive, a touch function is also possible. The driver only moves if the button is pressed down.

If the button is pressed down longer than T2, the device does not transmit any further telegram. The drive continues moving until the end position is reached.

**i** In this using mode, the device does not transmit a telegram as soon as a button is pressed. This makes it possible in the rocker configuration to also detect a full surface operation.

Times T1 ("time between a step and move command") and T2 ("slat adjusting time") must first be adjusted.

| Parameters                               | Description                                    | Value                       |
|--|--|-----------------------------|
| Duration between short-long key-press T1 | T1 is the time between a step and move command | 1 ... 4 *... 3000 (x100 ms) |
| Duration of the slat angle setting T2    | T2 is the slat adjusting time                  | 1 ... 5 *... 3000 (x100 ms) |

Table20: Time setting under "Long – Short or Short"

\* Default value

| Parameters  | Description   | Value   |
|---|---|---|
| Function blind<br>(Individual push-button configuration)                              | In the sun protection type, this parameter selects the function of the independent push-buttons.                                  | Up *<br>Down<br>Up/Down/Stop<br>Position (0-100 %)<br>Position/slat angle (0-100 %)<br>Slat angle (0-100 %) |
| Function upon press on top<br>Function upon press on bottom<br>(Configuration rocker) | In the sun protection type, this parameter selects the function of the top and bottom rocker side                                 | Up *<br>Down<br>Up/Down/Stop<br>Position (0-100 %)<br>Position/slat angle (0-100 %)<br>Slat angle (0-100 %) |
| Position (0-100 %) <sup>1</sup>   | This parameter allows the shutter/ blind to reach a specific position by pressing a button. The value is set using the sliderbar. | 0 % * ... 100 %   |
| Slat angle (0-100 %) <sup>2</sup>   | This parameter allows a specific blind slat angle to be set by pressing a button. The value is set using the sliderbar.           | 0 % * ... 100 %   |

Table21: Blind, shutter and slat position parameters

<sup>1</sup> This parameter is only visible when the value "Position (0-100 %)" or "Position/slat angle (0-100 %)" is selected in the "Function when pressing the rocker side/independent push-button" parameter.

<sup>2</sup> This parameter is only visible when the value "Slat angle (0-100 %)" or "Position/slat angle (0-100 %)" is selected in the "Function when pressing the rocker side/independent push-button".

"Up/Down" communication objects for shutter/blind operation (rocker)

| No.    | Name       | Object function       | Length | Data type         |
|--------|------------|-----------------------|--------|-------------------|
| 18, 58 | Rocker x-y | Up/Down               | 1 bits | 1.008 DPT_Up/Down |
| 19, 59 | Rocker x-y | Slat Step/Stop (step) | 1 bits | 1.007 DPT_Step    |

"Position (0-100 %)" communication objects for shutter/blind operation (rocker)

| No.    | Name       | Object function | Length | Data type                      |
|--------|------------|-----------------|--------|--------------------------------|
| 22.62, | Rocker x-y | Position in %   | 1 byte | 5.001 DPT_Percentage (0-100 %) |

Communication objects "Position/slat angle (0..100%)" for shutter/blind operation (rocker)

| No.    | Name       | Object function | Length | Data type                      |
|--------|------------|-----------------|--------|--------------------------------|
| 22.62  | Rocker x-y | Position in %   | 1 byte | 5.001 DPT_Percentage (0-100 %) |
| 23, 63 | Rocker x-y | Slat angle in % | 1 byte | 5.001 DPT_Percentage (0-100 %) |

"Slat angle (0-100 %)" communication objects for shutter/blind operation (rocker)

| No.    | Name       | Object function | Length | Data type                      |
|--------|------------|-----------------|--------|--------------------------------|
| 23, 63 | Rocker x-y | Slat angle in % | 1 byte | 5.001 DPT_Percentage (0-100 %) |

\* Default value

"Up/Down" communication objects for shutter/blind operation (button)

| No.              | Name     | Object function       | Length | Data type         |
|------------------|----------|-----------------------|--------|-------------------|
| 18, 38,<br>58.78 | Button x | Up/Down               | 1 bits | 1.008 DPT_Up/Down |
| 19, 39,<br>59.79 | Button x | Slat Step/Stop (step) | 1 bits | 1.007 DPT_Step    |

"Position (0-100 %)" communication objects for shutter/blind operation (button)

| No.             | Name     | Object function | Length | Data type                      |
|-----------------|----------|-----------------|--------|--------------------------------|
| 22.42,<br>62.82 | Button x | Position in %   | 1 byte | 5.001 DPT_Percentage (0-100 %) |

Communication objects "Position/slat angle (0..100%)" for shutter/blind operation (button)

| No.              | Name     | Object function | Length | Data type                      |
|------------------|----------|-----------------|--------|--------------------------------|
| 22.42,<br>62.82  | Button x | Position in %   | 1 byte | 5.001 DPT_Percentage (0-100 %) |
| 23, 43,<br>63.83 | Button x | Slat angle in % | 1 byte | 5.001 DPT_Percentage (0-100 %) |

"Slat angle (0-100 %)" communication objects for shutter/blind operation (button)

| No.              | Name     | Object function | Length | Data type                      |
|------------------|----------|-----------------|--------|--------------------------------|
| 23, 43,<br>63.83 | Button x | Slat angle in % | 1 byte | 5.001 DPT_Percentage (0-100 %) |

## 4.6 "Value 1 bytes" function

In the following parameter window, the "Value 1 byte" function is parameterised and set as a rocker or independent push-button in the using mode.

The application provides a 1-byte communication object for each rocker or independent push-button. Pressing a button transmits the set value to the bus. In the "rocker" using mode, different values can be parameterised and set for the two rocker sides.

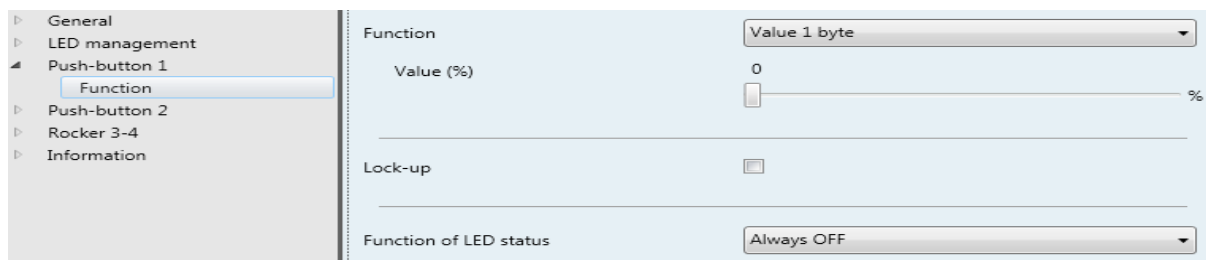

Figure 21: Function of the "Value 1 byte" rocker

| Parameters  | Description   | Value                            |
|---|---|----------------------------------|
| Function<br>(Individual push-button configuration)                                    | This parameter assigns the independent push-button one of the following object values. The 1-byte value as a percentage is set using the sidebar.   | <b>Percentage (0 ... 100%) *</b> |
| Function upon press on top<br>Function upon press on bottom<br>(Configuration rocker) | This parameter assigns the rocker one of the following object values when pressed. A distinction is made here between the push-button functions when it is pressed on top or bottom. The 1-byte value as a percentage is set using the sidebar. | <b>Percentage (0 ... 100%) *</b> |

Table22: Function of the "Value 1 byte" rocker/independent push-button

"Value 1 byte (0-100 %)" communication objects (rocker)

| No.    | Name       | Object function | Length | Data type            |
|--------|------------|-----------------|--------|----------------------|
| 22.62, | Rocker x-y | Value in %      | 1 byte | 5.001 DPT_Percentage |

"Value 1 byte (0-100 %)" communication objects (button)

| No.               | Name     | Object function | Length | Data type            |
|-------------------|----------|-----------------|--------|----------------------|
| 22, 42,<br>62.82, | Button x | Value in %      | 1 byte | 5.001 DPT_Percentage |

The "Value 1 byte" parameter defines which value range the push-button should use. Relative values ranging from 0 to 100 % can be transmitted to the bus for the "Value 1 byte" function by means of a slide control.

\* Default value



## 4.7 "Value 2 bytes" function

In the following parameter window, the "Value 2 bytes" function is parameterised and set as a rocker or button in the using mode.

The application provides a 2-byte communication object for each rocker or button. Pressing a button transmits the set value to the bus. In the "rocker" using mode, different values can be parameterised and set for the two rocker sides.

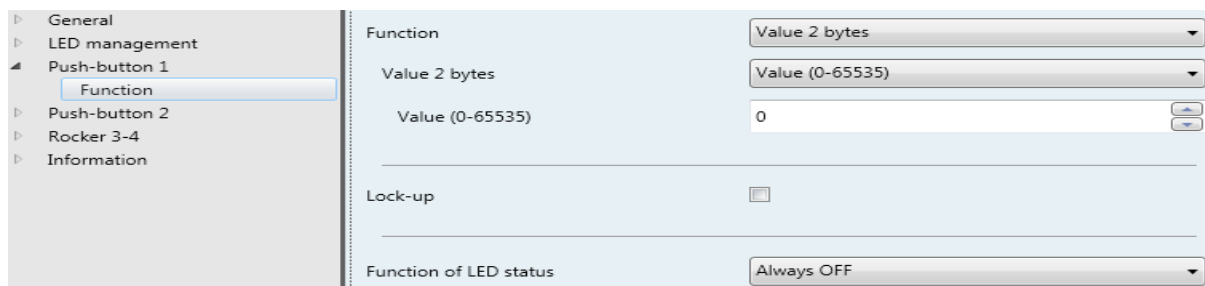

Figure 22: Function of the "Value 2 bytes" independent push-button

| Parameters   | Description  | Value   |
|--|--|---|
| Function of the "Value 2 bytes" independent push-button <sup>1</sup><br>(Individual push-button configuration)                               | This parameter assigns the independent push-button one of the following object values when pressed.  | <b>Value (0-65535) *</b><br>temperature<br>brightness |
| Function of the rocker "Value 2 bytes" <sup>1</sup><br>Function upon press on top<br>Function upon press on bottom<br>(Configuration rocker) | This parameter assigns the rocker one of the following object values when pressed. A distinction is made here between the push-button functions when it is pressed on top or bottom. | <b>Value (0-65535) *</b><br>temperature<br>brightness |

Table23: Function of the "Value 2 bytes" rocker/independent push-button

<sup>1</sup> If the respective function value is selected, another parameter window opens for setting the desired 2-byte value (0-65535 / 0-1000 Lux / 0- 40°C).

### "Value 2 bytes" communication objects (rocker)

| No.    | Name       | Object function   | Length | Data type                  |
|--------|------------|-------------------|--------|----------------------------|
| 24.64  | Rocker x-y | Value (0-65535)   | 2 byte | 7.001 DPT_Pulse            |
| 24.64, | Rocker x-y | Temperature value | 2 byte | 9.001 DPT_Temperature (°C) |
| 24.64  | Rocker x-y | Brightness value  | 2 byte | 9.004 DPT_Lux (Lux)        |

### "Value 2 bytes" communication objects (independent push-button)

| No.              | Name     | Object function   | Length | Data type                  |
|------------------|----------|-------------------|--------|----------------------------|
| 24.44,<br>64, 84 | Button x | Value (0-65535)   | 2 byte | 7.001 DPT_Pulse            |
| 24.44,<br>64, 84 | Button x | Temperature value | 2 byte | 9.001 DPT_Temperature (°C) |
| 24.44,<br>64, 84 | Button x | Brightness value  | 2 byte | 9.004 DPT_Lux (Lux)        |

\* Default value

## 4.8 Function "Room thermostat extension unit"

This function allows an external KNX room thermostat (KNX thermostat or KNX room controller, for example) to be activated using the push-button module operation button.

This allows the user to change/adjust basic controller functions (such as operating mode change-over or heating/cooling change-over) from different places in the room.

- i** The thermostat extension is, however, not actively involved in the actual calculation of the temperature control.
- i** The thermostat extension only works properly when all communication objects are connected to the appropriate objects in the associated KNX thermostat with a group address.

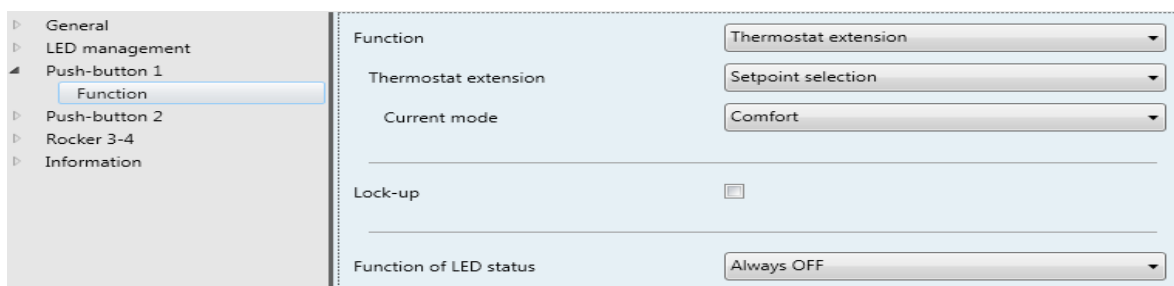

Figure 23: Function of the "Thermostat extension" independent push-button

| Parameters  | Description   | Value  |
|---|---|--|
| Function of the "Thermostat extension" independent push-button <sup>1</sup><br>(Individual push-button configuration)                               | This parameter assigns the following function to the rocker in the "Thermostat extension" function. A distinction is made here between the push-button functions when it is pressed on top or bottom. | <b>Override setpoint *</b><br>Heating/cooling-changeover |
| Function of the "Thermostat extension" rocker <sup>1</sup><br>Function upon press on top<br>Function upon press on bottom<br>(Configuration rocker) | This parameter assigns the following function to the push-button in the "Thermostat extension" function when the button is pressed.   | <b>Override setpoint *</b><br>Heating/cooling-changeover |

Table24: Function of the "Thermostat extension" rocker/button

<sup>1</sup> If the respective function value is selected, another parameter window opens for setting the desired function type.

\* Default value

| Parameters                    | Description  | Value  |
|-------------------------------|--|--|
| Operating mode changeover     | <p>This parameter defines which operating mode is transmitted to the KNX when a button is pressed (on the controller extension).</p> <p>Rocker function: different operating modes can be set for the top and bottom rocker sides</p> <p>Independent push-button: one operating mode assigned for when the button is pressed</p> | Auto<br>Comfort *<br>Standby<br>Night Reduction<br>Frost Protection. |
| Heating/cooling – change-over | <p>With this parameter, each time the independent push-button or rocker (top/ bottom) is pressed, the function of the heating system (heating/cooling) is changed over.</p> <p>Two 1-bit objects are available for communication here (changeover and status indication).</p>  |  |

Table25: Function of the "Thermostat extension" rocker/independent push-button

The "Override setpoint" function allows the "Comfort", "Standby", "Frost protection", "Night setpoint" or "Auto" operating modes to be transmitted to the bus.

**Example:**

- Comfort
 

The **Comfort** operating mode sets the room temperature to a temperature value predefined in the thermostat (comfort temperature 21°C, for example) for comfort (presence).
- Standby
 

The **Standby** operating mode reduces the room temperature after leaving the room (brief absence) to a value predefined in the thermostat (19°C, for example).
- Frost protection
 

The **Frost protection** operating mode reduces the heating circuit temperature to a minimum temperature of 7°C defined in the controller to protect against frost damage over night or during periods of extended absence.
- Night lowering
 

The **Night setpoint** operating mode turns down the room temperature during a long absence (holiday, for example) to a value of 17°C, for example, defined in the thermostat.
- Auto
 

The **Auto** operating mode automatically resets the operating mode to the current operating mode (after forced position, for example).

 With underfloor heating, the change-over from "Comfort" to Standby is only noticeable after a certain period of time due to the sluggishness of the underfloor heating system.

\* Default value

"Override setpoint" communication objects (rocker)

| No.    | Name       | Object function   | Length | Data type            |
|--------|------------|-------------------|--------|----------------------|
| 22.62, | Rocker x-y | Override setpoint | 1 byte | 20.102 DPT_HVAC mode |

"Override setpoint" communication objects (independent push-button)

| No.                | Name     | Object function   | Length | Data type            |
|--------------------|----------|-------------------|--------|----------------------|
| 22, 42,<br>62, 82, | Button x | Override setpoint | 1 byte | 20.102 DPT_HVAC mode |

"Heating/cooling-changeover" communication objects (rocker)

| No.    | Name       | Object function                     | Length | Data type                 |
|--------|------------|-------------------------------------|--------|---------------------------|
| 13.53, | Rocker x-y | Heating/cooling - status indication | 1 bits | 1.100 DPT_heating/cooling |
| 18.58, | Rocker x-y | Heating/cooling-changeover          | 1 bits | 1.100 DPT_heating/cooling |

"Heating/cooling-changeover" communication objects (independent push-button)

| No.              | Name     | Object function                     | Length | Data type                 |
|------------------|----------|-------------------------------------|--------|---------------------------|
| 13.33,<br>53, 73 | Button x | Heating/cooling - status indication | 1 bits | 1.100 DPT_heating/cooling |
| 18.38,<br>58, 78 | Button x | Heating/cooling-changeover          | 1 bits | 1.100 DPT_heating/cooling |

## 4.9 "Priority" function

The "Priority" function for the independent push-button and rocker is configured in this section. This function allows a switch output to be forced to a switch position by a 2-bit telegram regardless of the ON/OFF object (higher priority).

**The value of the 2-bit telegram is defined according to the following syntax:**

When "Priority" is active, incoming switch telegrams are still evaluated internally; when "Priority" is no longer active, the current internal switch condition, according to the ON/OFF object value, is set.

A "Priority" function activated before a bus voltage failure is always deactivated after a bus voltage recovery. The effect of the "Priority" function depends on the actuator channel connected (lighting, shutter/blind, heating).

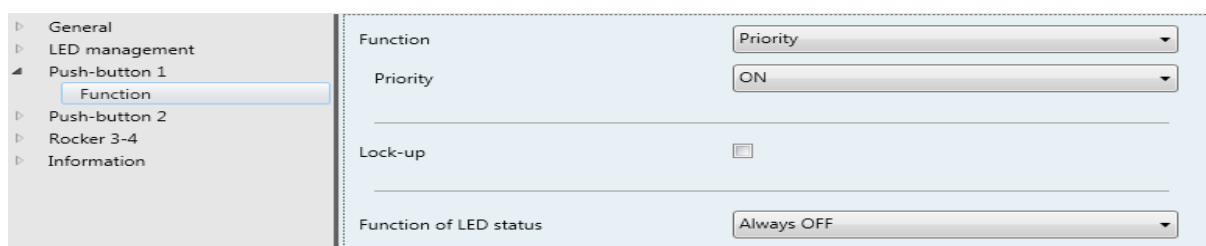

Figure 24: "Priority" function

| Value |       | Output behaviour  |
|-------|-------|-------------------|
| Bit 1 | Bit 0 |                   |
| 0     | 0/1   | End of "Priority" |
| 1     | 0     | "Priority" OFF    |
| 1     | 1     | "Priority" ON     |

Table26: "Priority" 2-bit communication object

| Parameters   | Description  | Value       |
|--|--|-------------|
| Function of the "Priority" independent push-button<br>(Individual push-button configuration)                               | This parameter assigns the following function to the independent push-button in the "Priority" function when the button is pressed.  | ON *<br>Off |
| Function of the "Priority" rocker<br>Function upon press on top<br>Function upon press on bottom<br>(Configuration rocker) | This parameter assigns the following function to the rocker in the "Priority" function. A distinction is made here between the rocker functions when it is pressed on top or bottom. | ON *<br>Off |

Table27: Function of the "Priority" rocker/independent push-button

\* Default value

"Priority" communication objects (rocker)

| No.    | Name       | Object function            | Length | Data type        |
|--------|------------|----------------------------|--------|------------------|
| 13, 53 | Rocker x-y | Priority status indication | 1 bits | 1.011 DPT_Status |
| 20.60  | Rocker x-y | Mandatory control          | 2 bits | 2.001 DPT_Status |

"Priority" communication objects (independent push-button)

| No.              | Name     | Object function            | Length | Data type        |
|------------------|----------|----------------------------|--------|------------------|
| 13.33,<br>53, 73 | Button x | Priority status indication | 1 bits | 1.011 DPT_Status |
| 20.40,<br>60.80  | Button x | Mandatory control          | 2 bits | 2.001 DPT_Status |

**Example: "Window cleaner" function**

The window cleaner function is an application that prevents a manual operation of the blind/roller shutter from being executed during the window cleaning. As a result, the blind/roller shutter operation is disabled from a central point. Blinds that have already been lowered are moved to the upper stop position. The manual blind/roller shutter function is also enabled from a central point.

## 4.10 "Scene" function

In the following parameter window, the "Scene" function is parameterised and set as a rocker and button in the operating concept.

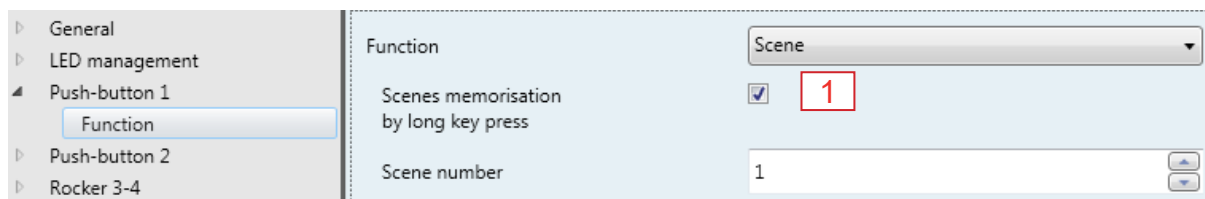

Figure 25: "Scene" function

The "Scene" function can be used as a scene extension and can be used to call up or save configured light scenes that are stored in other KNX devices. The device can call up and save a maximum of 64 scenes. Through a short key-press, the device transmits a value between 0 and 63 (where value 0 corresponds to scene 1 and value 63 corresponds to scene 64) to the bus via the scene control communication object. The scene is called up when the button is released.

| Bit number |   |   |   |   |   |   |   |
|------------|---|---|---|---|---|---|---|
| 7          | 6 | 5   | 4 | 3 | 2 | 1 | 0 |
| Save       | X | Scene number (0 = scene 1 ---- bit no. +1 = scene number) |   |   |   |   |   |

Table28: Structure of 1-byte scene communication object

X = not relevant.

If the scene memorisation function is activated with a long key-press, the scene parameter values can be connected to the device and stored with a long key-press. Scene memorisation can also be deactivated with a long key-press (untick box Figure 25, 1).

| Parameters   | Description  | Value   |
|--|--|---|
| Function of the "Scene" (scene extension) push-button (Individual push-button configuration)   | This parameter assigns a scene number to the push-button in the "Scene" function when the button is pressed.   | Scene number (1*-64)  |
| Function of the "Scene" (scene extension) rocker<br>Function upon press on top<br>Function upon press on bottom (Configuration rocker) | This parameter assigns a scene number to the rocker in the "Scene" function. A distinction is made here between the rocker functions when it is pressed up/down. | Scene number, top button (1*-64)<br>Scene number, bottom button (1*-64) |
| Scene memorisation by long key-press <sup>1</sup>  | A changed scene can be saved again by activating this function by ticking the box.   |   |

Table29: Function of the "Scene" rocker/independent push-button

<sup>1</sup> Scene memorisation is confirmed by the flashing of the respective status LED of the button (1 second).

If the parameters of a scene are changed by the device, the new scene parameters can be saved by a long press of the button.

\* Default value

"Scene" communication objects (rocker)

| No.    | Name       | Object function | Length | Data type                |
|--------|------------|-----------------|--------|--------------------------|
| 22, 62 | Rocker x-y | Scene           | 1 byte | 18.001 DPT_Scene control |

"Scene" communication objects (independent push-button)

| No.            | Name     | Object function | Length | Data type                |
|----------------|----------|-----------------|--------|--------------------------|
| 22, 42, 62, 82 | Button x | Scene           | 1 byte | 18.001 DPT_Scene control |

**Example: scene memorisation procedure**

- Switch on scene (in this example "Scene TV") by briefly pressing the button on the push-button module (Figure 26, A-1)  
 Scene is activated e.g., lighting dimmed to 30%, blind closed to 85%)

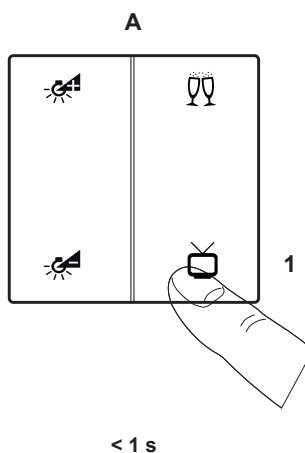

Figure 26: Scene call-up

Set and save new scene parameters on the push-button.

- Change lighting intensity, dim up or down (Figure 27, B)

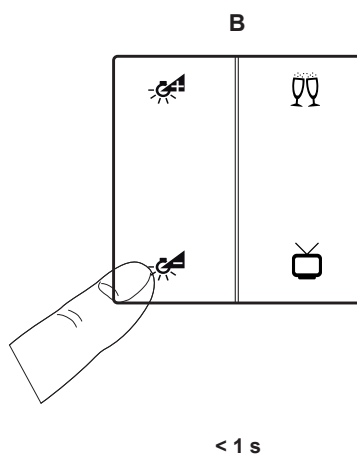

Figure 27: Setting new scene parameters



- Hold the button for "Scene TV" for longer than 5 s (Figure 28, C-1)  
New scene parameters have been saved. Pressing the "Scene TV" button again activates the new scene settings.

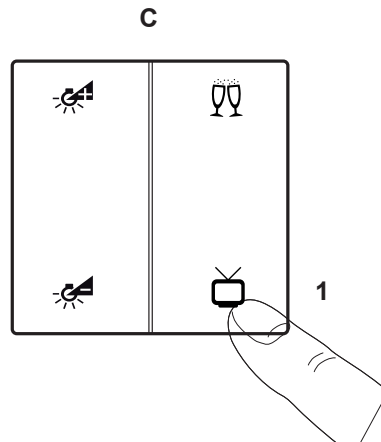

Figure 28: Saving new scene parameters

- i** The "Save scene by a long key-press" function is switched on by default.

## 4.11 "Deactivate automatic functions" function

The "deactivate automatic functions" function is described and presented in the following section.



Figure 29: "Automatic control deactivation" parameter

### "Automatic control" communication objects (rocker)

| No.    | Name       | Object function                       | Length | Data type        |
|--------|------------|---------------------------------------|--------|------------------|
| 13, 53 | Rocker x-y | Automatic control deactivation status | 1 bits | 1.003 DPT_Enable |
| 18, 58 | Rocker x-y | Deactivate automatic                  | 1 bits | 1.003 DPT_Enable |

### "Priority" communication objects (independent push-button)

| No.              | Name     | Object function                       | Length | Data type        |
|------------------|----------|---------------------------------------|--------|------------------|
| 13.33,<br>53, 73 | Button x | Automatic control deactivation status | 1 bits | 1.003 DPT_Enable |
| 18.38,<br>58, 78 | Button x | Deactivate automatic                  | 1 bits | 1.003 DPT_Enable |

With this 1-bit communication object automatic sequences already running in the actuators can be deactivated, switched off.

### Example: time-dependent outside lighting ON/OFF

The outside lighting is switched on and off at a certain time every day of the week.

However, on certain occasions (garden parties) the outside lighting should stay on for longer. In such cases, the "Automatic control deactivation" function is used to deactivate/switch off the time-dependent switching on/off of the outside lighting. To do so, a 1-bit command is transmitted to the bus.

## 5. "Information" parameter window

This parameter window specifies which application, database version and translation version the deployed device works with.

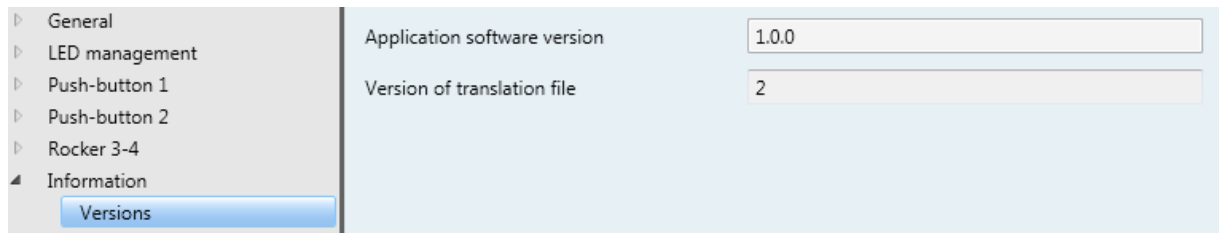

Figure 30: "Information" parameter window

## 6. Communication objects

### 6.1 "General" communication objects

#### 6.1.1 Blocking function

|   |         |         |       |   |   |   |   |   |       |     |
|---|---------|---------|-------|---|---|---|---|---|-------|-----|
| 4 | General | Lock-up | 1 bit | C | - | W | - | - | state | Low |
|---|---------|---------|-------|---|---|---|---|---|-------|-----|

Figure 31: "General - Lock-up" communication objects

| No. | Name    | Object function   | Length | Data type  | Flags |
|-----|---------|-------------------|--------|------------|-------|
| 4   | General | Blocking function | 1 bits | DPT_Status | C, W  |

This object is always visible but must be activated for each independent push-button/rocker separately.  
 This object enables the locking-up of another independent push-button/rocker; a 0/1 is transmitted to the respective lock-up object of the other device or the independent push-button/rocker is locked-up by another device when a 0/1 is received.  
 For further information see „3.1 Blocking function“.

### 6.2 Status LED communication objects

#### 6.2.1 "Direction LED ON/OFF" brightness

|    |                |                               |        |   |   |   |   |                      |     |
|----|----------------|-------------------------------|--------|---|---|---|---|----------------------|-----|
| 5  | LED management | Day/night                     | 1 bit  | C | - | W | - | -                    | Low |
| 6  | LED management | Device LED - ON/OFF           | 1 bit  | C | - | W | - | switch               | Low |
| 9  | LED management | Status LED - luminosity day   | 1 Byte | C | - | W | - | percentage (0..100%) | Low |
| 11 | LED management | Status LED - luminosity night | 1 Byte | C | - | W | - | percentage (0..100%) | Low |

Figure 32: "LED management" communication objects

| No. | Name                  | Object function   | Length | Data type     | Flags |
|-----|-----------------------|-------------------|--------|---------------|-------|
| 5   | Status LED brightness | Day/Night         | 1 bits |               | C, W  |
| 6   | Status LED brightness | Device LED ON/OFF | 1 bits | DPT_Switching | C, W  |

These objects become visible when the "Status LED brightness" function is activated under "Status LED brightness – General".  
 This object enables the device LEDs to be permanently switched on/off.  
 For further information see „3.3 "Status LED brightness" parameter“.

#### 6.2.2 Change of brightness value through object

| No. | Name                  | Object function               | Length | Data type                | Flags |
|-----|-----------------------|-------------------------------|--------|--------------------------|-------|
| 9   | Status LED brightness | Status LED – brightness day   | 1 byte | DPT_Percentage (0-100 %) | C, W  |
| 11  | Status LED brightness | Status LED – brightness night | 1 byte | DPT_Percentage (0-100 %) | C, W  |

These objects become visible when the "Change of brightness value through object" function is activated under "Status LED brightness – General".  
 These objects enable the changing of the status LED brightness value for daytime and nighttime operation.  
 For further information see „3.3 "Status LED brightness" parameter“.

## 6.3 "Independent push-button/rocker" communication objects

### 6.3.1 Toggle switch

|    |            |                          |       |   |   |   |   |   |        |     |
|----|------------|--------------------------|-------|---|---|---|---|---|--------|-----|
| 13 | Rocker 1-2 | Status indication ON/OFF | 1 bit | C | - | W | T | U | switch | Low |
| 18 | Rocker 1-2 | ON/OFF                   | 1 bit | C | - | - | T | - | switch | Low |
| 53 | Rocker 3-4 | Status indication ON/OFF | 1 bit | C | - | W | T | U | switch | Low |
| 58 | Rocker 3-4 | ON/OFF                   | 1 bit | C | - | - | T | - | switch | Low |

Figure 33: Rocker "Toggle switch" communication object

|    |               |                          |       |   |   |   |   |   |        |     |
|----|---------------|--------------------------|-------|---|---|---|---|---|--------|-----|
| 13 | Push-button 1 | Status indication ON/OFF | 1 bit | C | - | W | T | U | switch | Low |
| 18 | Push-button 1 | ON/OFF                   | 1 bit | C | - | - | T | - | switch | Low |
| 33 | Push-button 2 | Status indication ON/OFF | 1 bit | C | - | W | T | U | switch | Low |
| 38 | Push-button 2 | ON/OFF                   | 1 bit | C | - | - | T | - | switch | Low |
| 53 | Push-button 3 | Status indication ON/OFF | 1 bit | C | - | W | T | U | switch | Low |
| 58 | Push-button 3 | ON/OFF                   | 1 bit | C | - | - | T | - | switch | Low |
| 73 | Push-button 4 | Status indication ON/OFF | 1 bit | C | - | W | T | U | switch | Low |
| 78 | Push-button 4 | ON/OFF                   | 1 bit | C | - | - | T | - | switch | Low |

Figure 34: Independent push-button "Toggle switch" communication object

| No.           | Name     | Object function          | Length | Data type     | Flags      |
|---------------|----------|--------------------------|--------|---------------|------------|
| 13, 53,       | Rocker x | ON/OFF status indication | 1 bits | DPT_Switching | C, W, T, U |
| 13.33, 53.73, | Button x |                          |        |               |            |
| 18, 58,       | Rocker x | Switching                | 1 bits | DPT_Switching | C, T       |
| 18.38 58.78,  | Button x |                          |        |               |            |

These objects are activated when the "Toggle switch" function is selected in the parameters for each independent push-button/rocker.

These objects (13,33,53,73) allow the return of the status value for the respective switching command. The return of the status value is used for switching an actuator channel by two buttons in toggle mode.

These objects (18,38,58,78) transmit a 1-bit command to the actuator channel and trigger a switching command when a button is pressed.

For further information see „4.2 "Toggle switch" function“.

### 6.3.2 Switching

|    |            |        |       |   |   |   |   |   |        |     |
|----|------------|--------|-------|---|---|---|---|---|--------|-----|
| 18 | Rocker 1-2 | ON/OFF | 1 bit | C | - | - | T | - | switch | Low |
| 58 | Rocker 3-4 | ON/OFF | 1 bit | C | - | - | T | - | switch | Low |

Figure 35: Rocker "ON/OFF" communication object

|    |               |        |       |   |   |   |   |   |        |     |
|----|---------------|--------|-------|---|---|---|---|---|--------|-----|
| 18 | Push-button 1 | ON/OFF | 1 bit | C | - | - | T | - | switch | Low |
| 38 | Push-button 2 | ON/OFF | 1 bit | C | - | - | T | - | switch | Low |
| 58 | Push-button 3 | ON/OFF | 1 bit | C | - | - | T | - | switch | Low |
| 78 | Push-button 4 | ON/OFF | 1 bit | C | - | - | T | - | switch | Low |

Figure 36: Button "ON/OFF" communication object

| No.             | Name     | Object function | Length | Data type     | Flags |
|-----------------|----------|-----------------|--------|---------------|-------|
| 18, 58,         | Rocker x | Switching       | 1 bits | DPT_Switching | C, T  |
| 18.38<br>58.78, | Button x |                 |        |               |       |

These objects are activated when the "ON/OFF" function is selected in the parameters for each independent push-button/rocker.

These objects (18,38,58,78) transmit a 1-bit command to the actuator channel and trigger a switching command when a button is pressed.

For further information see „4.3 "ON/OFF" function“.

### 6.3.3 Dimming

|    |            |         |       |   |   |   |   |   |                 |     |
|----|------------|---------|-------|---|---|---|---|---|-----------------|-----|
| 18 | Rocker 1-2 | ON/OFF  | 1 bit | C | - | - | T | - | switch          | Low |
| 21 | Rocker 1-2 | Dimming | 4 bit | C | - | - | T | - | dimming control | Low |
| 58 | Rocker 3-4 | ON/OFF  | 1 bit | C | - | - | T | - | switch          | Low |
| 61 | Rocker 3-4 | Dimming | 4 bit | C | - | - | T | - | dimming control | Low |

Figure 37: Rocker "Dimming - ON/OFF" communication object

|    |               |         |       |   |   |   |   |   |                 |     |
|----|---------------|---------|-------|---|---|---|---|---|-----------------|-----|
| 18 | Push-button 1 | ON/OFF  | 1 bit | C | - | - | T | - | switch          | Low |
| 21 | Push-button 1 | Dimming | 4 bit | C | - | - | T | - | dimming control | Low |
| 38 | Push-button 2 | ON/OFF  | 1 bit | C | - | - | T | - | switch          | Low |
| 41 | Push-button 2 | Dimming | 4 bit | C | - | - | T | - | dimming control | Low |
| 58 | Push-button 3 | ON/OFF  | 1 bit | C | - | - | T | - | switch          | Low |
| 61 | Push-button 3 | Dimming | 4 bit | C | - | - | T | - | dimming control | Low |
| 78 | Push-button 4 | ON/OFF  | 1 bit | C | - | - | T | - | switch          | Low |
| 81 | Push-button 4 | Dimming | 4 bit | C | - | - | T | - | dimming control | Low |

Figure 38: Button "Dimming - ON/OFF" communication object

| No.             | Name     | Object function | Length | Data type     | Flags |
|-----------------|----------|-----------------|--------|---------------|-------|
| 18, 58,         | Rocker x | Switching       | 1 bits | DPT_Switching | C, T  |
| 18.38<br>58.78, | Button x |                 |        |               |       |
| 21.61,          | Rocker x | Dimming         | 4 bits | DPT_Switching | C, T  |
| 21.41<br>61.81, | Button x |                 |        |               |       |

These objects are activated when the "Dimming - Increase (ON)/Decrease (OFF)" function is selected in the parameters for each independent push-button/rocker.

The objects (18, 38, 58, 78) transmit a 1-bit command to the dimmer actuator channel and trigger a switching command and the objects (21, 41, 61, 81) transmit a 4-bit command to the dimmer actuator channel and trigger a dimming command when the button is pressed.

For further information see „4.4 “Dimming” Function“.

|    |            |                          |       |   |   |   |   |   |                 |     |
|----|------------|--------------------------|-------|---|---|---|---|---|-----------------|-----|
| 13 | Rocker 1-2 | Status indication ON/OFF | 1 bit | C | - | W | T | U | switch          | Low |
| 18 | Rocker 1-2 | ON/OFF                   | 1 bit | C | - | - | T | - | switch          | Low |
| 21 | Rocker 1-2 | Dimming                  | 4 bit | C | - | - | T | - | dimming control | Low |
| 53 | Rocker 3-4 | Status indication ON/OFF | 1 bit | C | - | W | T | U | switch          | Low |
| 58 | Rocker 3-4 | ON/OFF                   | 1 bit | C | - | - | T | - | switch          | Low |
| 61 | Rocker 3-4 | Dimming                  | 4 bit | C | - | - | T | - | dimming control | Low |

Figure 39: Rocker "Dimming - Toggle switch" communication object

|    |               |                          |       |   |   |   |   |   |                 |     |
|----|---------------|--------------------------|-------|---|---|---|---|---|-----------------|-----|
| 13 | Push-button 1 | Status indication ON/OFF | 1 bit | C | - | W | T | U | switch          | Low |
| 18 | Push-button 1 | ON/OFF                   | 1 bit | C | - | - | T | - | switch          | Low |
| 21 | Push-button 1 | Dimming                  | 4 bit | C | - | - | T | - | dimming control | Low |
| 33 | Push-button 2 | Status indication ON/OFF | 1 bit | C | - | W | T | U | switch          | Low |
| 38 | Push-button 2 | ON/OFF                   | 1 bit | C | - | - | T | - | switch          | Low |
| 41 | Push-button 2 | Dimming                  | 4 bit | C | - | - | T | - | dimming control | Low |
| 53 | Push-button 3 | Status indication ON/OFF | 1 bit | C | - | W | T | U | switch          | Low |
| 58 | Push-button 3 | ON/OFF                   | 1 bit | C | - | - | T | - | switch          | Low |
| 61 | Push-button 3 | Dimming                  | 4 bit | C | - | - | T | - | dimming control | Low |
| 73 | Push-button 4 | Status indication ON/OFF | 1 bit | C | - | W | T | U | switch          | Low |
| 78 | Push-button 4 | ON/OFF                   | 1 bit | C | - | - | T | - | switch          | Low |
| 81 | Push-button 4 | Dimming                  | 4 bit | C | - | - | T | - | dimming control | Low |

Figure 40: Button "Dimming - Toggle switch" communication object

| No.              | Name     | Object function          | Length | Data type     | Flags      |
|------------------|----------|--------------------------|--------|---------------|------------|
| 13.53,           | Rocker x | ON/OFF status indication | 1 bits | DPT_Switching | C, W, T, U |
| 13.33,<br>53.73, | Button x |                          |        |               |            |
| 18, 58,          | Rocker x | Switching                | 1 bits | DPT_Switching | C, T       |
| 18.38<br>58.78,  | Button x |                          |        |               |            |
| 21.61,           | Rocker x | Dimming                  | 4 bits | DPT_Switching | C, T       |
| 21.41<br>61.81,  | Button x |                          |        |               |            |

These objects are activated when the "Dimming - Increase (toggle switch)/Decrease (toggle switch)" function is selected in the parameters for each independent push-button/rocker.

The objects (18, 38, 58, 78) transmit a 1-bit command to the dimmer actuator channel and trigger a switching command and the objects (21, 41, 61, 81) transmit a 4-bit command to the dimmer actuator channel and trigger a dimming command when the button is pressed. The objects (13, 33, 53, 73) allow the return of the status value for the respective switching command (for linking with a status LED, for example).

For further information see „4.4 “Dimming” Function“.

|    |            |                  |        |   |   |   |   |   |                      |     |
|----|------------|------------------|--------|---|---|---|---|---|----------------------|-----|
| 22 | Rocker 1-2 | Brightness value | 1 Byte | C | - | - | T | - | percentage (0..100%) | Low |
| 62 | Rocker 3-4 | Brightness value | 1 Byte | C | - | - | T | - | percentage (0..100%) | Low |

Figure 41: Rocker "Dimming - dimming value" communication object

|    |               |                  |        |   |   |   |   |   |                      |     |
|----|---------------|------------------|--------|---|---|---|---|---|----------------------|-----|
| 22 | Push-button 1 | Brightness value | 1 Byte | C | - | - | T | - | percentage (0..100%) | Low |
| 42 | Push-button 2 | Brightness value | 1 Byte | C | - | - | T | - | percentage (0..100%) | Low |
| 62 | Push-button 3 | Brightness value | 1 Byte | C | - | - | T | - | percentage (0..100%) | Low |
| 82 | Push-button 4 | Brightness value | 1 Byte | C | - | - | T | - | percentage (0..100%) | Low |

Figure 42: Button "Dimming - dimming value" communication object

| No.              | Name     | Object function | Length | Data type                | Flags |
|------------------|----------|-----------------|--------|--------------------------|-------|
| 22.62,           | Rocker x | Dimming value   | 1 byte | DPT_Percentage (0-100 %) | C, T  |
| 22.42,<br>62.82, | Button x |                 |        |                          |       |

These objects are activated when the "Dimming - dimming value" function is selected in the parameters for each independent push-button/rocker.

The objects (22, 42, 62, 82) transmit a 1-byte command to the dimmer actuator channel and switch on the lighting at a fixed percentage value when the button is pressed.

For further information see „4.4 “Dimming” Function“.



### 6.3.4 Shutter/blind

|    |            |                         |       |   |   |   |   |   |         |     |
|----|------------|-------------------------|-------|---|---|---|---|---|---------|-----|
| 18 | Rocker 1-2 | Up/down                 | 1 bit | C | - | - | T | - | up/down | Low |
| 19 | Rocker 1-2 | Step/stop (short press) | 1 bit | C | - | - | T | - | step    | Low |
| 58 | Rocker 3-4 | Up/down                 | 1 bit | C | - | - | T | - | up/down | Low |
| 59 | Rocker 3-4 | Step/stop (short press) | 1 bit | C | - | - | T | - | step    | Low |

Figure 43: Rocker "Shutter/blind" communication object

|    |               |                         |       |   |   |   |   |   |         |     |
|----|---------------|-------------------------|-------|---|---|---|---|---|---------|-----|
| 18 | Push-button 1 | Up/down                 | 1 bit | C | - | - | T | - | up/down | Low |
| 19 | Push-button 1 | Step/stop (short press) | 1 bit | C | - | - | T | - | step    | Low |
| 38 | Push-button 2 | Up/down                 | 1 bit | C | - | - | T | - | up/down | Low |
| 39 | Push-button 2 | Step/stop (short press) | 1 bit | C | - | - | T | - | step    | Low |
| 58 | Push-button 3 | Up/down                 | 1 bit | C | - | - | T | - | up/down | Low |
| 59 | Push-button 3 | Step/stop (short press) | 1 bit | C | - | - | T | - | step    | Low |
| 78 | Push-button 4 | Up/down                 | 1 bit | C | - | - | T | - | up/down | Low |
| 79 | Push-button 4 | Step/stop (short press) | 1 bit | C | - | - | T | - | step    | Low |

Figure 44: Button "Shutter/blind" communication object

| No.              | Name     | Object function       | Length | Data type      | Flags |
|------------------|----------|-----------------------|--------|----------------|-------|
| 18.58,           | Rocker x | Up/down               | 1 bits | DPT_Up/Down    | C, T  |
| 18.38,<br>58.78, | Button x |                       |        |                |       |
| 19.59,           | Rocker x | Slat Step/Stop (step) | 1 bits | DPT_Step       | C, T  |
| 19.39,<br>59.79, | Button x |                       |        |                |       |
| 22.62,           | Rocker x | Position in %         | 1 byte | DPT_Percentage | C, T  |
| 22.42,<br>62.82, | Button x |                       |        |                |       |
| 23.63,           | Rocker x | Slat angle in %       | 1 byte | DPT_Percentage | C, T  |
| 23.43,<br>63.83, | Button x |                       |        |                |       |

These objects are activated when the "Shutter/blind" function is selected in the parameters for each independent push-button/rocker.

The objects (18, 38, 58, 78) transmit a 1-bit command to the shutter/roller actuator channel and move the hanging up/down when the button is pressed.

The objects (19, 39, 59, 79) transmit a 1-bit command to the shutter/roller actuator channel and stop the shutter/blind movement or gradually change the position of the hanging.

The objects (22, 42, 62, 82) transmit a 1-byte command to the shutter/roller actuator channel and and the position of the hanging.

The objects (23, 43, 63, 83) transmit a 1-byte command to the shutter/roller actuator channel and gradually change the position of the slats.

For further information see „4.5 "Shutter/blind" function“.

### 6.3.5 Value 1 bytes

|    |            |            |        |   |   |   |   |   |                      |     |
|----|------------|------------|--------|---|---|---|---|---|----------------------|-----|
| 22 | Rocker 1-2 | Value in % | 1 Byte | C | - | - | T | - | percentage (0..100%) | Low |
| 62 | Rocker 3-4 | Value in % | 1 Byte | C | - | - | T | - | percentage (0..100%) | Low |

Figure 45: Rocker "Value 1 bytes" communication object

|    |               |            |        |   |   |   |   |   |                      |     |
|----|---------------|------------|--------|---|---|---|---|---|----------------------|-----|
| 22 | Push-button 1 | Value in % | 1 Byte | C | - | - | T | - | percentage (0..100%) | Low |
| 42 | Push-button 2 | Value in % | 1 Byte | C | - | - | T | - | percentage (0..100%) | Low |
| 62 | Push-button 3 | Value in % | 1 Byte | C | - | - | T | - | percentage (0..100%) | Low |
| 82 | Push-button 4 | Value in % | 1 Byte | C | - | - | T | - | percentage (0..100%) | Low |

Figure 46: Button "Value 1 bytes" communication object

| No.              | Name     | Object function | Length | Data type                | Flags |
|------------------|----------|-----------------|--------|--------------------------|-------|
| 22.62,           | Rocker x | Value in %      | 1 byte | DPT_Percentage (0-100 %) | C, T  |
| 22.42,<br>62.82, | Button x |                 |        |                          |       |

These objects are activated when the "Value 1 bytes" function is selected in the parameters for each independent push-button/rocker.

The objects (22, 42, 62, 82 - value) transmit a 2-byte command to a switching actuator channel and switch the lighting on at a defined value when the button is pressed.

For further information see „4.6 "Value 1 bytes" function“.

### 6.3.6 Value 2 bytes

|    |            |                 |        |   |   |   |   |   |        |     |
|----|------------|-----------------|--------|---|---|---|---|---|--------|-----|
| 24 | Rocker 1-2 | Value (0-65535) | 2 Byte | C | - | - | T | - | pulses | Low |
| 64 | Rocker 3-4 | Value (0-65535) | 2 Byte | C | - | - | T | - | pulses | Low |

Figure 47: Rocker "Value 2 bytes" communication object

|    |               |                 |        |   |   |   |   |   |        |     |
|----|---------------|-----------------|--------|---|---|---|---|---|--------|-----|
| 24 | Push-button 1 | Value (0-65535) | 2 Byte | C | - | - | T | - | pulses | Low |
| 44 | Push-button 2 | Value (0-65535) | 2 Byte | C | - | - | T | - | pulses | Low |
| 64 | Push-button 3 | Value (0-65535) | 2 Byte | C | - | - | T | - | pulses | Low |
| 84 | Push-button 4 | Value (0-65535) | 2 Byte | C | - | - | T | - | pulses | Low |

Figure 48: Button "Value 2 bytes" communication object

| No.              | Name     | Object function | Length | Data type            | Flags |
|------------------|----------|-----------------|--------|----------------------|-------|
| 24.64,           | Rocker x | Value (0-65535) | 2 byte | DPT_Pulse            | C, T  |
| 24.44,<br>64.84, | Button x |                 |        |                      |       |
| 24.64,           | Rocker x | Temperature     | 2 byte | DPT_Temperature (°C) | C, T  |
| 24.44,<br>64.84, | Button x |                 |        |                      |       |
| 24.64,           | Rocker x | Brightness      | 2 byte | DPT_Lux (Lux)        | C, T  |
| 24.44,<br>64.84, | Button x |                 |        |                      |       |

These objects are activated when the "Value 2 bytes" function is selected in the parameters for each independent push-button/rocker.

The objects (24, 44, 64, 84 - value) transmit a 2-byte command to a switching actuator channel and switch the lighting on at a defined value when the button is pressed.

The objects (24, 44, 64, 84 - temperature) transmit a 2-byte command to a thermostat and change the set temperature, for example, when the button is pressed.

The objects (24, 44, 64, 84 - brightness) transmit a 2-byte command to a dimming actuator channel and switch the lighting on at a defined brightness value when the button is pressed.

For further information see „4.7 "Value 2 bytes" function“

### 6.3.7 Thermostat extension

|    |            |                    |        |   |   |   |   |   |           |     |
|----|------------|--------------------|--------|---|---|---|---|---|-----------|-----|
| 22 | Rocker 1-2 | Setpoint selection | 1 Byte | C | - | - | T | - | HVAC mode | Low |
| 62 | Rocker 3-4 | Setpoint selection | 1 Byte | C | - | - | T | - | HVAC mode | Low |

Figure 49: Rocker "Thermostat extension" communication object

|    |               |                    |        |   |   |   |   |   |           |     |
|----|---------------|--------------------|--------|---|---|---|---|---|-----------|-----|
| 22 | Push-button 1 | Setpoint selection | 1 Byte | C | - | - | T | - | HVAC mode | Low |
| 42 | Push-button 2 | Setpoint selection | 1 Byte | C | - | - | T | - | HVAC mode | Low |
| 62 | Push-button 3 | Setpoint selection | 1 Byte | C | - | - | T | - | HVAC mode | Low |
| 82 | Push-button 4 | Setpoint selection | 1 Byte | C | - | - | T | - | HVAC mode | Low |

Figure 50: Button "Thermostat extension" communication object

| No.              | Name     | Object function                     | Length | Data type           | Flags      |
|------------------|----------|-------------------------------------|--------|---------------------|------------|
| 22.62,           | Rocker x | Override setpoint                   | 1 byte | DPT_HVAC Mode       | C, T       |
| 22.42,<br>62.82, | Button x |                                     |        |                     |            |
| 13.53,           | Rocker x | Heating/cooling - status indication | 1 bits | DPT_heating/cooling | C, W, T, U |
| 13.33,<br>53.73, | Button x |                                     |        |                     |            |
| 18.58,           | Rocker x | Heating/cooling-changeover          | 1 bits | DPT_heating/cooling | C, T       |
| 18.38,<br>58.78, | Button x |                                     |        |                     |            |

These objects are activated when the "Thermostat extension" function is selected in the parameters for each independent push-button/rocker.

The objects (22, 42, 62, 82) transmit a 1-byte command to a thermostat and change the operating mode there (comfort, standby, etc.) when the button is pressed.

The objects (13, 33, 53, 73) transmit a 1-bit command to the bus and show the "Heating or cooling" status, for example, on a display when the button is pressed.

The objects (18, 38, 58, 78) transmit a 1-bit command to a heating actuator and can therefore switch back and forth between heating and cooling mode.

 The heating system must be equipped for heating and cooling operation.

For further information see „4.8 Function "Room thermostat extension unit“.

### 6.3.8 Mandatory control

|    |            |                            |       |   |   |   |   |   |                 |     |
|----|------------|----------------------------|-------|---|---|---|---|---|-----------------|-----|
| 13 | Rocker 1-2 | Status indication priority | 1 bit | C | - | W | T | U | state           | Low |
| 20 | Rocker 1-2 | Priority                   | 2 bit | C | - | - | T | - | boolean control | Low |
| 53 | Rocker 3-4 | Status indication priority | 1 bit | C | - | W | T | U | state           | Low |
| 60 | Rocker 3-4 | Priority                   | 2 bit | C | - | - | T | - | boolean control | Low |

Figure 51: Rocker "Priority" communication object

|    |               |                            |       |   |   |   |   |   |                 |     |
|----|---------------|----------------------------|-------|---|---|---|---|---|-----------------|-----|
| 13 | Push-button 1 | Status indication priority | 1 bit | C | - | W | T | U | state           | Low |
| 20 | Push-button 1 | Priority                   | 2 bit | C | - | - | T | - | boolean control | Low |
| 33 | Push-button 2 | Status indication priority | 1 bit | C | - | W | T | U | state           | Low |
| 40 | Push-button 2 | Priority                   | 2 bit | C | - | - | T | - | boolean control | Low |
| 53 | Push-button 3 | Status indication priority | 1 bit | C | - | W | T | U | state           | Low |
| 60 | Push-button 3 | Priority                   | 2 bit | C | - | - | T | - | boolean control | Low |
| 73 | Push-button 4 | Status indication priority | 1 bit | C | - | W | T | U | state           | Low |
| 80 | Push-button 4 | Priority                   | 2 bit | C | - | - | T | - | boolean control | Low |

Figure 52: Button "Priority" communication object

| No.           | Name     | Object function         | Length | Data type           | Flags      |
|---------------|----------|-------------------------|--------|---------------------|------------|
| 13.53,        | Rocker x | Priority status display | 1 bits | DPT_Status          | C, W, T, U |
| 13.33, 53.73, | Button x |                         |        |                     |            |
| 20.60,        | Rocker x | Mandatory control       | 2 bits | DPT_Boolean control | C, T       |
| 20.40, 60.80, | Button x |                         |        |                     |            |

These objects are activated when the "Priority" function is selected in the parameters for each independent push-button/rocker.

The objects (13, 33, 53, 73) transmit a 1-bit command to the bus and show the "Priority" status, for example, on a display when the button is pressed.

The objects (20, 40, 60, 80) transmit a 2-bit command and switch an actuator channel (shutter/blind) into forced mode (movement operation of a shutter is locked) when the button is pressed.

For further information see „4.9 "Priority" function“.

### 6.3.9 Scene

|    |            |       |        |   |   |   |   |   |               |     |
|----|------------|-------|--------|---|---|---|---|---|---------------|-----|
| 22 | Rocker 1-2 | Scene | 1 Byte | C | - | - | T | - | scene control | Low |
| 62 | Rocker 3-4 | Scene | 1 Byte | C | - | - | T | - | scene control | Low |

Figure 53: Rocker "Scene" communication object

|    |               |       |        |   |   |   |   |   |               |     |
|----|---------------|-------|--------|---|---|---|---|---|---------------|-----|
| 22 | Push-button 1 | Scene | 1 Byte | C | - | - | T | - | scene control | Low |
| 42 | Push-button 2 | Scene | 1 Byte | C | - | - | T | - | scene control | Low |
| 62 | Push-button 3 | Scene | 1 Byte | C | - | - | T | - | scene control | Low |
| 82 | Push-button 4 | Scene | 1 Byte | C | - | - | T | - | scene control | Low |

Figure 54: Button "Scene" communication object

| No.                | Name     | Object function | Length | Data type             | Flags |
|--------------------|----------|-----------------|--------|-----------------------|-------|
| 22, 62,            | Rocker x | Scene           | 1 byte | DPT_Scenes<br>Control | C, T  |
| 22, 42,<br>62, 82, | Button x |                 |        |                       |       |

These objects are activated when the "Scene" function is selected in the parameters for each independent push-button/rocker.

The objects (22, 42, 62, 82) transmit a 1-byte command to the bus and switch on the respectively stored scene in the actuator channels (light TV 50%, shutters closed to 75%) when the button is pressed.

For further information see „4.10 "Scene" function“

### 6.3.10 Deactivate automatic

|    |            |                                       |       |   |   |   |   |   |        |     |
|----|------------|---------------------------------------|-------|---|---|---|---|---|--------|-----|
| 13 | Rocker 1-2 | Automatic control deactivation status | 1 bit | C | - | W | T | U | enable | Low |
| 18 | Rocker 1-2 | Automatic control deactivation        | 1 bit | C | - | - | T | - | enable | Low |
| 53 | Rocker 3-4 | Automatic control deactivation status | 1 bit | C | - | W | T | U | enable | Low |
| 58 | Rocker 3-4 | Automatic control deactivation        | 1 bit | C | - | - | T | - | enable | Low |

Figure 55: Rocker "Automatic mode" communication object

|    |               |                                       |       |   |   |   |   |   |        |     |
|----|---------------|---------------------------------------|-------|---|---|---|---|---|--------|-----|
| 13 | Push-button 1 | Automatic control deactivation status | 1 bit | C | - | W | T | U | enable | Low |
| 18 | Push-button 1 | Automatic control deactivation        | 1 bit | C | - | - | T | - | enable | Low |
| 33 | Push-button 2 | Automatic control deactivation status | 1 bit | C | - | W | T | U | enable | Low |
| 38 | Push-button 2 | Automatic control deactivation        | 1 bit | C | - | - | T | - | enable | Low |
| 53 | Push-button 3 | Automatic control deactivation status | 1 bit | C | - | W | T | U | enable | Low |
| 58 | Push-button 3 | Automatic control deactivation        | 1 bit | C | - | - | T | - | enable | Low |
| 73 | Push-button 4 | Automatic control deactivation status | 1 bit | C | - | W | T | U | enable | Low |
| 78 | Push-button 4 | Automatic control deactivation        | 1 bit | C | - | - | T | - | enable | Low |

Figure 56: Button "Automatic mode" communication object

| No.              | Name     | Object function                       | Length | Data type  | Flags      |
|------------------|----------|---------------------------------------|--------|------------|------------|
| 13.53,           | Rocker x | Automatic control deactivation status | 1 bits | DPT_Enable | C, W, T, U |
| 13.33<br>53.73,  | Button x |                                       |        |            |            |
| 18.58,           | Rocker x | Deactivate automatic                  | 1 bits | DPT_Enable | C, T       |
| 18.38,<br>58.78, | Button x |                                       |        |            |            |

These objects are activated when the "Automatic control deactivation" function is selected in the parameters for each independent button/rocker.

The objects (13, 33, 53, 73) transmit a 1-bit command to the bus and show the "Automatic mode" status, for example, on a display when the button is pressed.

The objects (18, 38, 58, 78) transmit a 1-bit command when the button is pressed which allows it to start/stop a set automatic mode.

For further information see „4.11 “Deactivate automatic functions” function“

## 7. Appendix

### 7.1 ETS software characteristics

| Product                        | 1gang push-button module | 2gang push-button module | 1gang group push-button module | 2gang group push-button module |
|--------------------------------|--------------------------|--------------------------|--------------------------------|--------------------------------|
| Max. number of Group addresses | 254                      | 254                      | 254                            | 254                            |
| Max. number of assignments     | 255                      | 255                      | 255                            | 255                            |
| Objects                        | 84                       | 84                       | 84                             | 84                             |

Table30: ETS software characteristics

### 7.2 Technical data

|                               |                                      |
|-------------------------------|--------------------------------------|
| KNX medium                    | TP 1                                 |
| Configuration mode            | system link                          |
| Rated voltage KNX             | 21 ... 32 V <sub>~</sub> SELV        |
| Current consumption KNX       | typ. 10 mA                           |
| Power consumption             | typ. 150 mW                          |
| Connection mode KNX           | bus connecting terminals             |
| Degree of protection          | IP 20                                |
| Protection class              | III                                  |
| Operating temperature         | -40 ... +30 °C                       |
| Storage/transport temperature | -50 ... +50 °C                       |
| Standards                     | EN 60669-2-1; EN 60669-1<br>EN 50428 |

### 7.3 Accessories

|                            |               |
|----------------------------|---------------|
| W.1 button cover xgang     | 8096 35 xx    |
| W.1 Frame xgang horizontal | 1329 xx xx    |
| W.1 Frame xgang vertical   | 1328 xx xx    |
| W.1 Housing xgang          | 67193 x xx xx |

### 7.4 Warranty

We reserve the right to realise technical and formal changes to the product in the interest of technical progress.

Our products are under guarantee within the scope of the statutory provisions.

If you have a warranty claim, please contact the point of sale.



## 8. Table of Figures

|   |    |
|---|----|
| Figure 1: Push-button module  | 5  |
| Figure 2: Device overview   | 6  |
| Figure 3: "Xgang push-button module" distribution                         | 7  |
| Figure 4: "Xgang group push-button module" distribution                   | 7  |
| Figure 5: General, "Parameters"   | 10 |
| Figure 6: General "Lock-up"   | 11 |
| Figure 7: Parameter „Using mode“  | 12 |
| Figure 8: Status LED brightness, "General"                                | 13 |
| Figure 9: Brightness of the "Status LED" status LED                       | 13 |
| Figure 10: Function type of the button(s)                                 | 15 |
| Figure 11: Function type of the rocker(s)                                 | 16 |
| Figure 12: Status LED of the rocker(s)                                    | 16 |
| Figure 13: "Toggle switch" function of the push-button(s)                 | 17 |
| Figure 14: "Function by press/on release" parameters                      | 18 |
| Figure 15: "Dimming" Function   | 19 |
| Figure 16: "Roller shutter/blind" function                                | 21 |
| Figure 17: "Short – Long – Short" operating concept                       | 23 |
| Figure 18: "Long – Short" operating concept                               | 25 |
| Figure 19: "Short – Long" using mode                                      | 27 |
| Figure 20: "Long – Short or Short" operating concept                      | 29 |
| Figure 21: Function of the "Value 1 byte" rocker                          | 32 |
| Figure 22: Function of the "Value 2 bytes" independent push-button        | 33 |
| Figure 23: Function of the "Thermostat extension" independent push-button | 34 |
| Figure 24: "Priority" function  | 37 |
| Figure 25: "Scene" function   | 39 |
| Figure 26: Scene call-up  | 40 |
| Figure 27: Setting new scene parameters                                   | 40 |
| Figure 28: Saving new scene parameters                                    | 41 |
| Figure 29: "Automatic control deactivation" parameter                     | 42 |
| Figure 30: "Information" parameter window                                 | 43 |
| Figure 31: "General - Lock-up" communication objects                      | 44 |
| Figure 32: "LED management" communication objects                         | 44 |
| Figure 33: Rocker "Toggle switch" communication object                    | 45 |
| Figure 34: Independent push-button "Toggle switch" communication object   | 45 |
| Figure 35: Rocker "ON/OFF" communication object                           | 46 |
| Figure 36: Button "ON/OFF" communication object                           | 46 |
| Figure 37: Rocker "Dimming - ON/OFF" communication object                 | 47 |
| Figure 38: Button "Dimming - ON/OFF" communication object                 | 47 |
| Figure 39: Rocker "Dimming - Toggle switch" communication object          | 47 |
| Figure 40: Button "Dimming - Toggle switch" communication object          | 47 |
| Figure 41: Rocker "Dimming - dimming value" communication object          | 48 |
| Figure 42: Button "Dimming - dimming value" communication object          | 48 |
| Figure 43: Rocker "Shutter/blind" communication object                    | 49 |

|   |    |
|---|----|
| Figure 44: Button "Shutter/blind" communication object        | 49 |
| Figure 45: Rocker "Value 1 bytes" communication object        | 50 |
| Figure 46: Button "Value 1 bytes" communication object        | 50 |
| Figure 47: Rocker "Value 2 bytes" communication object        | 51 |
| Figure 48: Button "Value 2 bytes" communication object        | 51 |
| Figure 49: Rocker "Thermostat extension" communication object | 52 |
| Figure 50: Button "Thermostat extension" communication object | 52 |
| Figure 51: Rocker "Priority" communication object             | 53 |
| Figure 52: Button "Priority" communication object             | 53 |
| Figure 53: Rocker "Scene" communication object                | 54 |
| Figure 54: Button "Scene" communication object                | 54 |
| Figure 55: Rocker "Automatic mode" communication object       | 55 |
| Figure 56: Button "Automatic mode" communication object       | 55 |

## 9. List of tables

|  |    |
|--|----|
| Table1: ETS Software version   | 4  |
| Table2: ETS Application designations   | 4  |
| Table3: General, "Parameters"  | 10 |
| Table4: General "Lock-up"  | 11 |
| Table5: Parameter „Using mode“   | 12 |
| Table6: LED management, "Status LED"   | 14 |
| Table7: "Button function type" parameters                                      | 15 |
| Table8: "Rocker function type" parameters                                      | 16 |
| Table9: "Function by press/on release" ON/OFF parameters                       | 18 |
| Table10: Rocker/button "Dimming" function                                      | 19 |
| Table11: "Shutter/blind" rocker/button using mode                              | 21 |
| Table12: Hager/Berker behaviour parameters                                     | 22 |
| Table13: Blind, shutter and slat position parameters                           | 22 |
| Table14: Time setting under "Short – Long – Short"                             | 23 |
| Table15: Blind, shutter and slat position parameters                           | 24 |
| Table16: Time setting under "Long – Short"                                     | 25 |
| Table17: Blind, shutter and slat position parameters                           | 26 |
| Table18: Time setting under "Short – Long"                                     | 27 |
| Table19: Blind, shutter and slat position parameters                           | 28 |
| Table20: Time setting under "Long – Short or Short"                            | 29 |
| Table21: Blind, shutter and slat position parameters                           | 30 |
| Table22: Function of the "Value 1 byte" rocker/independent push-button         | 32 |
| Table23: Function of the "Value 2 bytes" rocker/independent push-button        | 33 |
| Table24: Function of the "Thermostat extension" rocker/button                  | 34 |
| Table25: Function of the "Thermostat extension" rocker/independent push-button | 35 |
| Table26: "Priority" 2-bit communication object                                 | 37 |
| Table27: Function of the "Priority" rocker/independent push-button             | 37 |
| Table28: Structure of 1-byte scene communication object                        | 39 |
| Table29: Function of the "Scene" rocker/independent push-button                | 39 |
| Table30: ETS software characteristics  | 56 |