

**Push button 1gang comfort with
labeling field**

**Push button 2gang comfort with
labeling field**

**Push button 3gang comfort with
labeling field**

**Push button 4gang comfort with
labeling field**



Issue: 26.02.2009
656x0120

Content

1	<u>Product definition</u>	<u>3</u>
1.1	Product catalogue	3
1.2	Function	3
2	<u>Fitting, electrical connection and operation</u>	<u>4</u>
2.1	Safety instructions	4
2.2	Device components	5
2.3	Fitting and electrical connection	7
2.4	Commissioning	8
2.5	Operation	9
3	<u>Technical data</u>	<u>10</u>
4	<u>Software description</u>	<u>11</u>
4.1	Software specification	11
4.2	Push button xgang comfort 10Cx01 / 10Cx11	13
4.2.1	Scope of functions	13
4.2.2	Software information	15
4.2.3	Object table	16
4.2.4	Functional description	29
4.2.4.1	Operation concept and button evaluation	29
4.2.4.2	General settings	33
4.2.4.3	Rockers and pushbutton functions	34
4.2.4.3.1	"Switching" function	34
4.2.4.3.2	"Dimming" function	35
4.2.4.3.3	"Blind" function	37
4.2.4.3.4	"Value transmitter" function	41
4.2.4.3.5	"Scene extension" function	43
4.2.4.3.6	"2-channel operation" function	44
4.2.4.4	Status LED	46
4.2.4.5	Scene control	49
4.2.4.5.1	Scene definition and scene recall	49
4.2.4.5.2	Storing scenes	51
4.2.4.6	Disabling function	52
4.2.4.7	Controller extension	55
4.2.4.7.1	Connection to room thermostat	55
4.2.4.7.2	Button function "Operating mode switchover"	57
4.2.4.7.3	Button function "Presence button"	58
4.2.4.7.4	Button function "Setpoint shift"	59
4.2.4.8	Alarm signal	60
4.2.5	Delivery state	61
4.2.6	Parameters	62
5	<u>Appendix</u>	<u>98</u>
5.1	Index	98

1 Product definition

1.1 Product catalogue

Product name: Push button 1gang comfort with labeling field / Push button 2gang comfort with labeling field / Push button 3gang comfort with labeling field / Push button 4gang comfort with labeling field

Use: Sensor

Design: UP (concealed)

Order-No. 7514 13 xx / 7514 23 xx / 7514 33 xx / 7514 43 xx

1.2 Function

When its buttons are pushed, the Comfort pushbutton sensor sends telegrams to the KNX / EIB, depending on the ETS parameter settings. These can be, for instance, telegrams for switching or momentary-contact control, for dimming or for shutter control. It is also possible to program value transmitter functions, such as dimming value transmitters, light scene extensions, temperature value transmitters or brightness value transmitters.

In conjunction with a room thermostat equipped with a 1-byte object for switching the modes of operation, the Comfort pushbutton sensor can be used as a full-featured controller extension. The device can also be used for presence detection or for setpoint shifting purposes.

The Comfort pushbutton sensor consists of one or more operating areas, depending on the variant. The operation concept of an operating area can be configured in the ETS either as a rocker function or alternatively as a pushbutton function. With the rocker function, one operating area is divided into two actuation pressure points (left / right) with the same basic function. In the pushbutton function either an operating area is divided into 2 neighbouring, functionally-separate actuation pressure points (2 buttons), or an operating area is evaluated as single-surface operation (only one button).

If an operating area is used as a single rocker function, then it is also possible to trigger special functions using full-surface operation.

The Comfort pushbutton sensor has two status LEDs per operating area. These status LEDs can either be switched on or off permanently, or can function as a status indicator for a button or rocker. As an alternative, the LEDs can also be activated via separate communication objects. The LEDs can either indicate the switching status of an object statically or by flashing, signal operating states of room thermostats, or indicate results of logical value comparison operations.

When used, an operation LED can either serve as an orientation light (also flashing), or can be activated via a separate communication object. When the pushbutton sensor is in the programming mode, the operation LED flashes with a frequency of about 8 Hz. The same flashing rate is also used for indicating that a rocker has been actuated by a press on the full surface; in this case, the LED switches back to its configured behaviour when actuation ends. If no or a wrong application has been loaded into the pushbutton sensor, the operation LED flashes with a frequency of approx. 0.75 Hz to indicate an error and the pushbutton sensor does not work.

A bus coupling unit is already permanently integrated in the Comfort pushbutton sensor, allowing the device to be connected directly to the bus cable during commissioning.

2 Fitting, electrical connection and operation

2.1 Safety instructions

Electrical equipment must be installed and fitted by qualified electricians. Observe the current accident prevention regulations.

Failure to observe the instructions may cause damage to the device and result in fire and other hazards.

During installation, adequate insulation between the mains voltage and the bus must be ensured! A minimum distance of at least 4 mm must be maintained between bus conductors and mains voltage cores.

The device may not be opened or operated outside the technical specifications.

2.2 Device components

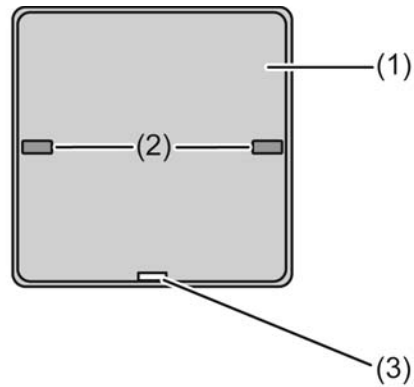

picture 1: Device components of the push button 1gang comfort

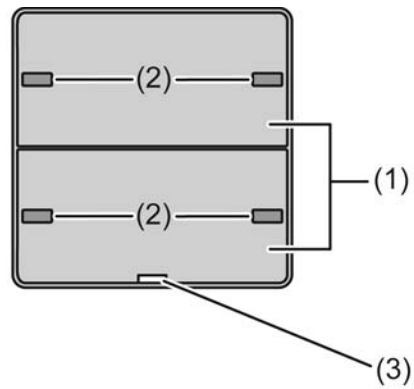

picture 2: Device components of the push button 2gang comfort

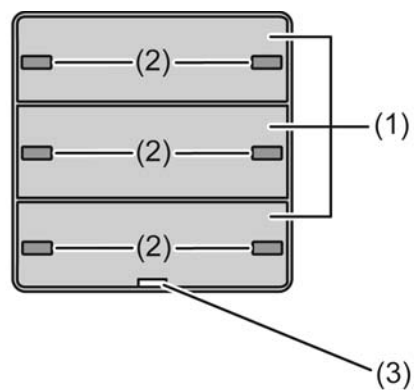

picture 3: Device components of the push button 3gang comfort

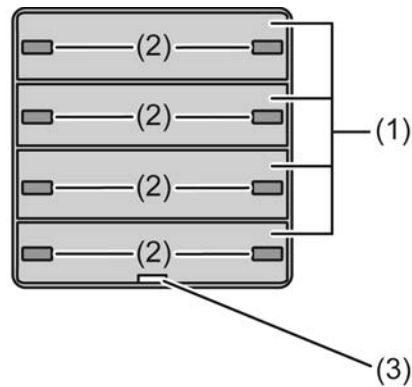

picture 4: Device components of the push button 4gang comfort

- (1) Operating areas (depending on the ETS configuration, as rocker or pushbutton function)
- (2) Status LED (orange)
- (3) Operation LED (white)

Dimensions:

Width (W): 58 mm / Height (H): 58 mm / Depth (D): 34 mm

i Data including flush-mounted section, without decorative frame, without supporting frame.

2.3 Fitting and electrical connection

Fitting and connecting the device

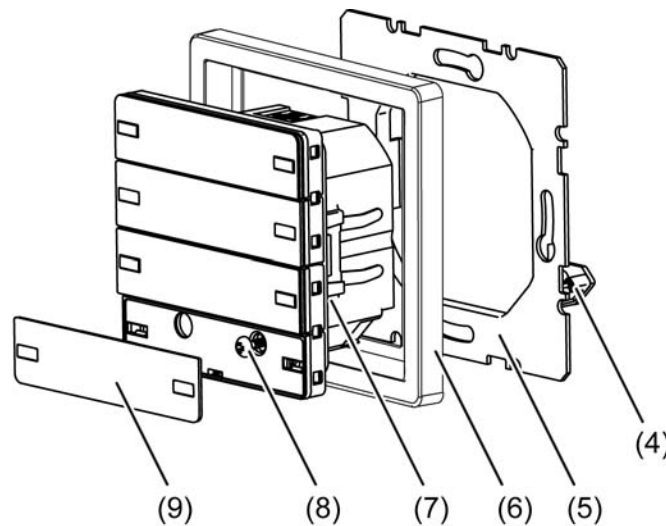

picture 5: Device fitting using the example of a push button 4gang comfort

- (4) Dismantling protection
- (5) Supporting ring
- (6) Frame
- (7) Pushbutton sensor
- (8) Retaining screw
- (9) Cover with labelling panel

- Fit the supporting frame (5) in the right position on an appliance box. The dismantling protection (4) must be at the bottom right.
- Run the bus cable with the connection terminal through the supporting frame (5) and the frame (6) and connect to the pushbutton sensor (7).
- Push the pushbutton sensor (7) with the frame (6) onto the supporting frame until it locks into place.
- Detach the cable with labelling panel (9) from the bottom rocker.
- Screw the retaining screw (8) tight. This is prefitted in the round opening.
- Clip the labelling panel (9) back onto the pushbutton sensor.

i To program the physical address, a cover with a labelling panel must be removed from the pushbutton sensor (see chapter 2.4. Commissioning).

2.4 Commissioning

Loading the physical address and application software

The start-up procedure of the device is basically confined to programming of the physical address and the application data with the ETS.

Project planning and commissioning of the device preferably using the ETS 3.0d with Patch A or newer versions.

The device is connected and ready for operation.

An appropriate device must be set up and configured in the ETS project.

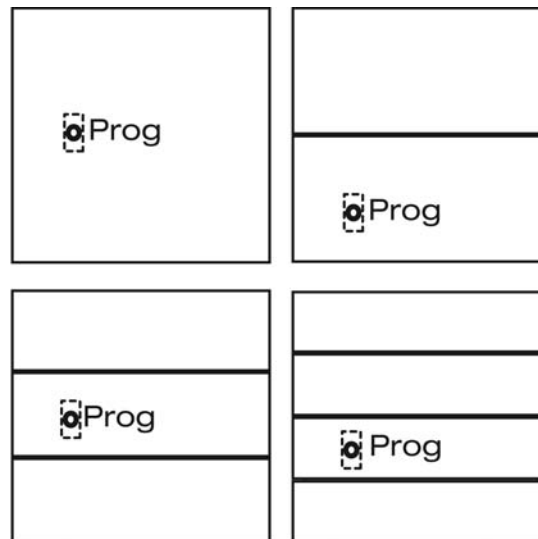

picture 6: Arrangement of the programming button dependent on the device variant

- i** The programming button is located behind a labelling panel. Refer to the image (picture 6) for the exact position - depending on the version.
 - Release the labelling panel above the programming button.
 - Activating Programming mode: press the programming button.
The operation LED (3) flashes quickly.
 - Program the physical address with the help of the ETS.
The operation LED (3) switches back to the previous status - off, on or flashing slowly.
 - Write the physical address on the device label.
 - Load the application data into the device using the ETS.
 - Reattach the labelling panel.
- i** If the device was programmed with incorrect application data, then operation LED flashes slowly. In this case, the device will not function after start-up.

2.5 Operation

Operating areas

The Comfort pushbutton sensor consists of one or more operating areas, depending on the variant. The operation concept of an operating area can be configured in the ETS either as a rocker function or alternatively as a pushbutton function. With the rocker function, one operating area is divided into two neighbouring actuation pressure points with the same basic function. In the pushbutton function either an operating area is divided into 2 functionally separate actuation pressure points (2 buttons), or an operating area is evaluated as single-surface operation (only one button). If an operating area is used as a single rocker function, then it is also possible to trigger special functions using full-surface operation.

The number of operating rockers depends on the device variant used.

Each operating area has two status LEDs (left & right), which, according to the function of the rocker or pushbuttons can be internally connected to the operating function. They may, however, also be used for signalling completely independent functions, flash or be permanently on or off.

The operation LED can also signal the switching state of its own object, flash or be permanently on or off. Besides functions that can be set using the ETS, the operation LED also indicates that the pushbutton sensor is in the programming mode for commissioning or diagnosis purposes.

Moreover, the pushbutton sensor has functions which are not immediately linked with the rockers or buttons and which must therefore be additionally enabled by the corresponding parameters. These include the thermostat extension function, pushbutton function disable, the internal scenes and the display of alarm signals.

- i** Configuration of the operating areas (button or rocker function and button arrangement) is described in detail in the chapter "Software description" (see page 29).

3 Technical data

General

Protection rating	IP 20
Safety class	III
Mark of approval	KNX / EIB
Ambient temperature	+5 ... +45 °C
Storage/transport temperature	-20 ... +70 °C

KNX / EIB supply

KNX medium	TP 1
Commissioning mode	S mode
Rated voltage KNX	DC 21 V ... 32 V SELV
Power consumption KNX	typical 150 mW
Connection mode KNX	Connection terminal

4 Software description

4.1 Software specification

ETS search paths:	- Push button / Push button 1gang / Push button 1gang comfort with labeling field
	- Push button / Push button 2gang / Push button 2gang comfort with labeling field
	- Push button / Push button 3gang / Push button 3gang comfort with labeling field
	- Push button / Push button 4gang / Push button 4gang comfort with labeling field
BAU used:	ASIC FZE 1065 + μ C
KNX/EIB type class:	3b device with cert. Physical layer + stack
Configuration:	S-mode standard
PEI type:	"00" _{Hex} / "0" _{Dec}
PEI connector:	No connector

Applications for Push button 1gang comfort:

No.	Short description	Name	Version	from screen version
1	Multifunctional pushbutton sensor application: 1 operating area (1 x rocker / 2 x buttons)	Push button 1gang comfort 10C101	0.1 for ETS 2 and ETS 3.0a...c	705
2		Push button 1gang comfort 10C111	1.1 for ETS3.0 Version d onwards	705

Applications for push button 2gang comfort:

No.	Short description	Name	Version	from screen version
1	Multifunctional pushbutton sensor application: 2 operating areas (2 x rockers / 4 x buttons)	Push button 2gang comfort 10C201	0.1 for ETS 2 and ETS 3.0a...c	705
2		Push button 2gang comfort 10C211	1.1 for ETS3.0 Version d onwards	705

Applications for push button 3gang comfort:

No.	Short description	Name	Version	from screen version
1	Multifunctional pushbutton sensor application: 3 operating areas (3 x rockers / 6 x buttons)	Push button 3gang comfort 10C301	0.1 for ETS 2 and ETS 3.0a...c	705
2		Push button 3gang comfort 10C311	1.1 for ETS3.0 Version don- wards	705

Applications for push button 4gang comfort:

No.	Short description	Name	Version	from screen version
1	Multifunctional pushbutton sensor application: 4 operating areas (4 x rockers / 8 x buttons)	Push button 4gang comfort 10C401	0.1 for ETS 2 and ETS 3.0a...c	705
2		Push button 4gang comfort 10C411	1.1 for ETS3.0 Version don- wards	705

4.2 Push button xgang comfort 10Cx01 / 10Cx11

4.2.1 Scope of functions

Scope of functions

- Each operating area can either be used as a single rocker or as two independent buttons.
- For pushbutton function either double-surface or single-surface principle.
- Each rocker can be used for the functions switching, dimming, shutter control, 1-byte value transmitter, 2-byte value transmitter and scene extension.
- Each button can be used for the functions switching, dimming, shutter control, 1-byte value transmitter, 2-byte value transmitter, scene extension and room thermostat extension value transmitter.
- 2-channel control is possible: each rocker or each button can be set for controlling two independent channels. This means that only one button-press is enough to transmit up to two telegrams to the bus. The channels can be configured independently of one another for the Switching, Value transmitter (1 byte) or Temperature value transmitter (2 bytes) functions.
- For the rocker functions Dimming, Venetian blind (operation concept "Long – Short or Short") and 2-channel operation, full-surface rocker actuation can also be evaluated. With full-surface rocker operation, switching telegrams and scene recall requests can be triggered on the bus in addition to and independently of the configured rocker function.
- The switching function permits the following settings: reaction after pressing and/or releasing, switching on and off and toggling.
- The dimming function permits the following settings: times for short and long actuation, dimming in different levels, telegram repetition on long press, transmission of stop telegram after end of press.
- The shutter control permits the following settings: four different operation concepts with times for short and long press and slat adjustment.
- The 1-byte and 2-byte value transmitter function permits the following settings: selection of the value range (0 ... 100 %, 0 ... 255, 0 ... 65535, 0 ... 1500 lux, 0 ... 40 °C), value on button-press, value change on sustained button-press with different level sizes, optional overflow on reaching the end of a value range.
- The scene control permits the following settings: Internal storage of eight scenes with eight output channels, recall of internal scenes by means of a presettable scene number, selection of object types for the output channels; for each scene, the storage of the individual output values and the transmission of the output values can be permitted or disabled; the individual channels can be delayed during scene recall; as scene extension 64 scenes can be recalled and stored.
- The controller extension function permits the following settings: operating mode selection with normal and high priority, defined selection of an operating mode, change between different operating modes, change of presence status, setpoint shift.
- Each operating area has two status LEDs.
- When a status LED is internally connected with the rocker or the button, it can signal a button-press or the current status of a communication object. The status can also be indicated in inverted form.
- When a status LED is not dependent on the rocker or button, it can be permanently on or off, indicate the status of an independent communication object, the operating state of a room thermostat or the result of a comparison between signed or unsigned 1 byte values.
- The operation LED can be permanently on or off or alternatively be switched via a communication object.

- The rockers or buttons can be disabled via a 1-bit object. The following settings are possible: polarity of the disabling object, behaviour at the beginning and at the end of disabling. During an active disable, all or some of the rockers / buttons can have no function, can perform the function of a selected button or execute one of two presettable disabling functions.
- All LEDs of the pushbutton sensor can flash simultaneously in the event of an alarm. The following settings are possible: Value of alarm signalling object for the states alarm / no alarm, alarm acknowledge by actuation of a button, transmission of the acknowledge signal to other devices.

4.2.2 Software information

ETS project design and start-up

For configuration and commissioning of this device, we recommended using ETS3.0d. Advantages with regard to downloading (significantly shorter loading times) and parameter programming can be expected only if this ETS patch version or later versions are used. The advantages are gained through the use of the new mask version 7.5 and the parameter presentation of ETS3.

The product database necessary for ETS3.0d is provided in *.VD4 format. The corresponding application program has the version number "1.1".

For the ETS2 and older versions of the ETS3 a separate product database in the *.VD2 format is available. The application program for these ETS versions is version number "0.1".

As far as the scope of functions of the parameters described in this documentation is concerned, there is no difference between the two application programs.

When older ETS versions are updated to the level of version ETS3.0d or to that of later versions, an additional tool in the form of an ETS3 add-in is available. This tool is able to convert older product databases with application version "0.1" – for example from existing ETS2 projects – into the new application format (version "1.1"). This way you can make use of the advantages of the ETS3.0d application easily and without changing the configuration. The ETS3 add-in can be obtained separately from the manufacturer and is free of charge.

4.2.3 Object table

Number of communication objects:	29 (1x variant) 35 (2x variant) 41 (3x variant) 47 (4x variant) (max. object number 74 - gaps in between)
Number of addresses (max):	120
Number of assignments (max):	120
Dynamic table management	Yes
Maximum table length	240

Objects for rocker or button function:

Function: Switching

Object	Function	Name	Type	DP type	Flag
 ⁰	Switching	Rocker/button 1 ^{1,2}	1-bit	1.xxx	C, W, T, (R) ³

Description 1-bit object for the transmission of switching telegrams (ON, OFF).

Function: Dimming

Object	Function	Name	Type	DP type	Flag
 ⁰	Switching	Rocker/button 1 ^{1,2}	1-bit	1.xxx	C, W, T, (R) ³

Description 1-bit object for the transmission of switching telegrams (ON, OFF).

Function: Dimming

Object	Function	Name	Type	DP type	Flag
 ¹⁸	Dimming	Rocker/button 1 ^{1,2}	4-bit	3,007	C, W, T, (R) ³

Description 4-bit object for the transmission of relative dimming telegrams.

1: The number of rockers or buttons depends on the planned device variant.

2: The objects have been described for rocker 1 or button 1 as an example. The objects for the other rockers/buttons are defined in the same way by shifting the object number and changing the object name.

3: For readout, the R flag must be set. The last value written to the object via the bus will be read.

Function: Venetian blind

Object	Function	Name	Type	DP type	Flag
 ⁰	Short time operation	Rocker/button 1 ^{1,2}	1-bit	1,007	C, -, T, (R) ₃

Description 1-bit object for the transmission of telegrams with which a Venetian blind or shutter drive motor can be stopped or with which the blind slats can be adjusted by short time operation.

Function: Venetian blind

Object	Function	Name	Type	DP type	Flag
 ¹⁸	Long time operation	Rocker/button 1 ^{1,2}	1-bit	1,008	C, W, T, (R) ₃

Description 1-bit object for the transmission of telegrams with which a Venetian blind or shutter drive motor can be moved up or down.

Function: 1-byte value transmitter

Object	Function	Name	Type	DP type	Flag
 ⁰	Value	Rocker/button 1 ^{1,2}	1-byte	5.xxx	C, W, T, (R) ₃

Description 1-byte object for the transmission of values from 0 to 255 (corresponding to values from 0 % to 100 %). If the adjustment of the value is enabled, the object can transmit telegrams cyclically after long actuation with which the value can be reduced or increased by a presettable amount.

Function: 2-byte value transmitter

Object	Function	Name	Type	DP type	Flag
 ⁰	Value	Rocker/button 1 ^{1,2}	2-byte	7.xxx	C, W, T, (R) ₃

Description 2-byte object for the transmission of values from 0 to 65535. If the adjustment of the value is enabled, the object can transmit cyclical telegrams after a long press with which the value can be reduced or increased by an adjustable amount.

1: The number of rockers or buttons depends on the planned device variant.

2: The objects have been described for rocker 1 or button 1 as an example. The objects for the other rockers/buttons are defined in the same way by shifting the object number and changing the object name.

3: For readout, the R flag must be set. The last value written to the object via the bus will be read.

Function: 2-byte value transmitter

Object	Function	Name	Type	DP type	Flag
 ⁰	Temperature value	Rocker/button 1 ^{1,2}	2-byte	9,001	C, W, T, (R) ³

Description 2 -byte object for the transmission of a temperature value from 0 °C to 40 °C. If the adjustment of the value is enabled, the object can transmit telegrams cyclically after a long press with which the value can be reduced or increased by 1 K.

Function: 2-byte value transmitter

Object	Function	Name	Type	DP type	Flag
 ⁰	Brightness value	Rocker/button 1 ^{1,2}	2-byte	9,004	C, W, T, (R) ³

Description 2-byte object for the transmission of a brightness level value from 0 lux to 1500. If the adjustment of the value is enabled, the object can transmit cyclical telegrams after a long press with which the value can be reduced or increased by 50 lux.

Function: Scene extension

Object	Function	Name	Type	DP type	Flag
 ⁰	Scene extension	Rocker/button 1 ^{1,2}	1-byte	18,001	C, -, T, (R) ₃

Description 1-byte object for recalling or for storing one of 64 scenes max. from a scene pushbutton sensor.

Function: 2-channel operation

Object	Function	Name	Type	DP type	Flag
 ⁰	Channel 1 switching	Rocker/button 1 ^{1,2}	1-bit	1.xxx	C, W, T, (R) ³

Description 1-bit object for the transmission of switching telegrams, if 2-channel operation is activated.

Function: 2-channel operation

Object	Function	Name	Type	DP type	Flag
 ⁰	Channel 1 value	Rocker/button 1 ^{1,2}	1-byte	5.xxx	C, -, T, (R) ₃

Description 1-byte object for the transmission of value telegrams, if 2-channel operation is activated.

1: The number of rockers or buttons depends on the planned device variant.

2: The objects have been described for rocker 1 or button 1 as an example. The objects for the other rockers/buttons are defined in the same way by shifting the object number and changing the object name.

3: For readout, the R flag must be set. The last value written to the object via the bus will be read.

Function: 2-channel operation

Object	Function	Name	Type	DP type	Flag
 ⁰	Channel 1 value	Rocker/button 1 ^{1,2}	2-byte	9,001	C, -, T, (R) ₃

Description 2-byte object for the transmission of value telegrams, if 2-channel operation is activated.

Function: 2-channel operation

Object	Function	Name	Type	DP type	Flag
 ¹⁸	Channel 2 switching	Rocker/button 1 ^{1,2}	1-bit	1.xxx	C, W, T, (R) ₃

Description 1-bit object for the transmission of switching telegrams, if 2-channel operation is activated.

Function: 2-channel operation

Object	Function	Name	Type	DP type	Flag
 ¹⁸	Channel 2 value	Rocker/button 1 ^{1,2}	1-byte	5.xxx	C, -, T, (R) ₃

Description 1-byte object for the transmission of value telegrams, if 2-channel operation is activated.

Function: 2-channel operation

Object	Function	Name	Type	DP type	Flag
 ¹⁸	Channel 2 value	Rocker/button 1 ^{1,2}	2-byte	9,001	C, -, T, (R) ₃

Description 2-byte object for the transmission of value telegrams, if 2-channel operation is activated.

1: The number of rockers or buttons depends on the planned device variant.

2: The objects have been described for rocker 1 or button 1 as an example. The objects for the other rockers/buttons are defined in the same way by shifting the object number and changing the object name.

3: For readout, the R flag must be set. The last value written to the object via the bus will be read.

Objects for full-surface operation with rocker function (with dimming, Venetian blind and 2-channel operation):

Function: Full-surface operation

Object	Function	Name	Type	DP type	Flag
 ¹	Switching	Rocker 1 full-surface operation _{1,2}	1-bit	1.xxx	C, W, T, (R) ³

Description 1-bit object for the transmission of switching telegrams (ON, OFF) when there is full-surface operation of an operating area.

Function: Full-surface operation

Object	Function	Name	Type	DP type	Flag
 ¹	Scene extension	Rocker 1 full-surface operation _{1,2}	1-byte	18,001	C, -, T, (R) ₃

Description 1-byte object for recalling or for storing one of 64 scenes max. from a scene pushbutton sensor in case of full-surface operation of an operating area.

Objects for status LED:

Function: Status LED in case of rocker function

Object	Function	Name	Type	DP type	Flag
 ³⁶	Status LED top	Rocker 1 ^{1,2}	1-bit	1.xxx	C, W, -, (R) ₃

Description 1-bit object for activation of the status LED.

Function: Status LED in case of rocker function

Object	Function	Name	Type	DP type	Flag
 ³⁶	Status LED top	Rocker 1 ^{1,2}	1-byte	5.xxx, 6.xxx, 20.102	C, W, -, (R) ₃

Description 1-byte object for activation of the status LED.

1: The number of rockers or buttons depends on the planned device variant.

2: The objects have been described for rocker 1 or button 1 as an example. The objects for the other rockers/buttons are defined in the same way by shifting the object number and changing the object name.

3: For readout, the R flag must be set. The last value written to the object via the bus will be read.

Function: Status LED in case of rocker function

Object	Function	Name	Type	DP type	Flag
 ³⁷	Status LED bottom	Rocker 1 ^{1,2}	1-bit	1.xxx	C, W, -, (R) ₃

Description 1-bit object for activation of the status LED.

Function: Status LED in case of rocker function

Object	Function	Name	Type	DP type	Flag
 ³⁷	Status LED bottom	Rocker 1 ^{1,2}	1-byte	5.xxx, 6.xxx, 20.102	C, W, -, (R) ₃

Description 1-byte object for activation of the status LED.

Function: Status LED in case of pushbutton function

Object	Function	Name	Type	DP type	Flag
 ³⁶	Status LED	Button 1 ^{1,2}	1-bit	1.xxx	C, W, -, (R) ₃

Description 1-bit object for activation of the status LED.

Function: Status LED in case of pushbutton function

Object	Function	Name	Type	DP type	Flag
 ³⁶	Status LED	Button 1 ^{1,2}	1-byte	5.xxx, 6.xxx, 20.102	C, W, -, (R) ₃

Description 1-byte object for activation of the status LED.

Objects for disabling functions:

Function: Switching

Object	Function	Name	Type	DP type	Flag
 ^{16, 17}	Switching	Disabling function 1 / 2	1-bit	1.xxx	C, W, T, (R) ₃

Description 1-bit object for the transmission of switching telegrams (ON, OFF).

1: The number of rockers or buttons depends on the planned device variant.

2: The objects have been described for rocker 1 or button 1 as an example. The objects for the other rockers/buttons are defined in the same way by shifting the object number and changing the object name.

3: For readout, the R flag must be set. The last value written to the object via the bus will be read.

Function: Dimming

Object	Function	Name	Type	DP type	Flag
 16, 17	Switching	Disabling function 1 / 2	1-bit	1.xxx	C, W, T, (R) ¹

Description 1-bit object for the transmission of switching telegrams (ON, OFF).

Function: Dimming

Object	Function	Name	Type	DP type	Flag
 34, 35	Dimming	Disabling function 1 / 2	4-bit	1,007	C, W, T, (R) ¹

Description 4-bit object for the transmission of relative dimming telegrams.

Function: Venetian blind

Object	Function	Name	Type	DP type	Flag
 16, 17	Short time operation	Disabling function 1 / 2	1-bit	1,007	C, -, T, (R) 1

Description 1-bit object for the transmission of telegrams with which a Venetian blind or shutter drive motor can be stopped or with which the blind slats can be adjusted by short time operation.

Function: Venetian blind

Object	Function	Name	Type	DP type	Flag
 34, 35	Long time operation	Disabling function 1 / 2	1-bit	1,008	C, W, T, (R) ¹

Description 1-bit object for the transmission of telegrams with which a Venetian blind or shutter drive motor can be moved up or down.

Function: 1-byte value transmitter

Object	Function	Name	Type	DP type	Flag
 16, 17	Value	Disabling function 1 / 2	1-byte	5.xxx	C, W, T, (R) ¹

Description 1-byte object for the transmission of values from 0 to 255 (corresponding to values from 0 % to 100 %). If the adjustment of the value is enabled, the object can transmit telegrams cyclically after long actuation with which the value can be reduced or increased by a presettable amount.

1: For readout, the R flag must be set. The last value written to the object via the bus will be read.

Function: 2-byte value transmitter

Object	Function	Name	Type	DP type	Flag
 16, 17	Value	Disabling function 1 / 2	2-byte	7.xxx	C, W, T, (R) ¹

Description 2-byte object for the transmission of values from 0 to 65535. If the adjustment of the value is enabled, the object can transmit cyclical telegrams after a long press with which the value can be reduced or increased by an adjustable amount.

Function: 2-byte value transmitter

Object	Function	Name	Type	DP type	Flag
 16, 17	Temperature value	Disabling function 1 / 2	2-byte	9,001	C, W, T, (R) ¹

Description 2 -byte object for the transmission of a temperature value from 0 °C to 40 °C. If the adjustment of the value is enabled, the object can transmit telegrams cyclically after a long press with which the value can be reduced or increased by 1 K.

Function: 2-byte value transmitter

Object	Function	Name	Type	DP type	Flag
 16, 17	Brightness value	Disabling function 1 / 2	2-byte	9,004	C, W, T, (R) ¹

Description 2-byte object for the transmission of a brightness level value from 0 lux to 1500. If the adjustment of the value is enabled, the object can transmit cyclical telegrams after a long press with which the value can be reduced or increased by 50 lux.

Function: Scene extension

Object	Function	Name	Type	DP type	Flag
 16, 17	Scene extension	Disabling function 1 / 2	1-byte	18,001	C, -, T, (R) ¹

Description 1-byte object for recalling or for storing one of 64 scenes max. from a scene pushbutton sensor.

Function: 2-channel operation

Object	Function	Name	Type	DP type	Flag
 16, 17	Channel 1 switching	Disabling function 1 / 2	1-bit	1.xxx	C, W, T, (R) ¹

Description 1-bit object for the transmission of switching telegrams, if 2-channel operation is activated.

1: For readout, the R flag must be set. The last value written to the object via the bus will be read.

Function: 2-channel operation

Object	Function	Name	Type	DP type	Flag
 16, 17	Channel 1 value	Disabling function 1 / 2	1-byte	5.xxx	C, -, T, (R) 1

Description 1-byte object for the transmission of value telegrams, if 2-channel operation is activated.

Function: 2-channel operation

Object	Function	Name	Type	DP type	Flag
 16, 17	Channel 1 value	Disabling function 1 / 2	2-byte	9,001	C, -, T, (R) 1

Description 2-byte object for the transmission of value telegrams, if 2-channel operation is activated.

Function: 2-channel operation

Object	Function	Name	Type	DP type	Flag
 34, 35	Channel 2 switching	Disabling function 1 / 2	1-bit	1.xxx	C, W, T, (R) 1

Description 1-bit object for the transmission of switching telegrams, if 2-channel operation is activated.

Function: 2-channel operation

Object	Function	Name	Type	DP type	Flag
 34, 35	Channel 2 value	Disabling function 1 / 2	1-byte	5.xxx	C, -, T, (R) 1

Description 1-byte object for the transmission of value telegrams, if 2-channel operation is activated.

Function: 2-channel operation

Object	Function	Name	Type	DP type	Flag
 34, 35	Channel 2 value	Disabling function 1 / 2	2-byte	9,001	C, -, T, (R) 1

Description 2-byte object for the transmission of value telegrams, if 2-channel operation is activated.

1: For readout, the R flag must be set. The last value written to the object via the bus will be read.

Function: Disabling function

Object	Function	Name	Type	DP type	Flag
 ⁵⁴	Disabling	Button disabling	1-bit	1,001	C, W, -, (R) 1

Description 1-bit object by means of which the pushbutton sensor can be disabled and enabled again (polarity configurable).

Object for operation LED:

Function: Operation LED

Object	Function	Name	Type	DP type	Flag
 ⁵²	Operation LED	Switching	1-bit	1,001	C, W, -, (R) 1

Description 1-bit object for switching the operation LED on or off ("1" = switch on; "0" = switch off).

Objects for alarm signalling:

Function: Alarm signal

Object	Function	Name	Type	DP type	Flag
 ⁵⁶	Switching	Alarm signal	1-bit	1.xxx	C, W, -, (R) 1

Description 1-bit object for the reception of an alarm signalling (polarity configurable).

Function: Alarm signal

Object	Function	Name	Type	DP type	Flag
 ⁵⁷	Switching	Alarm signalling acknowledge	1-bit	1.xxx	C, -, T, (R) 1

Description 1-bit object for transmitting the acknowledgement of an alarm signalling (polarity configurable).

1: For readout, the R flag must be set. The last value written to the object via the bus will be read.

Objects for the controller extension:

Function: Controller extension

Object	Function	Name	Type	DP type	Flag
 ⁵⁸	Operating mode switchover	Controller extension	1-byte	20,102	C, W, T, (R) ¹

Description 1-byte object for switching over a room thermostat between the Comfort, Standby, Night and Frost / heat protection operating modes.

Function: Controller extension

Object	Function	Name	Type	DP type	Flag
 ⁵⁹	Forced oper. mode switchover	Controller extension	1-byte	20,102	C, W, T, (R) ¹

Description 1-byte object for switching over a room thermostat under forced control between the Comfort, Standby, Night and Frost / heat protection operating modes

Function: Controller extension

Object	Function	Name	Type	DP type	Flag
 ⁶⁰	Presence button	Controller extension	1-bit	1,001	C, W, T, (R) ¹

Description 1-bit object for switching over the presence status of a room thermostat (polarity configurable)

Function: Controller extension

Object	Function	Name	Type	DP type	Flag
 ⁶¹	Setpoint shift specification	Controller extension	1-byte	6,010	C, -, T, (R) ₁ ¹

Description 1-byte object for presetting a basic setpoint shift for a controller.
 $x \leq 0 \leq y$ (0 = no shift active); integral numbers
 Value object 62 + 1 (increase level value)
 Value object 62 - 1 (decrease level value)
 The possible range of values (x to y) is fixed by the setpoint adjusting range to the 'upper limit' or to the 'lower limit' (configurable) in combination with the level value on the room thermostat.

1: For readout, the R flag must be set. The last value written to the object via the bus will be read.

Function: Controller extension

Object	Function	Name	Type	DP type	Flag
 ⁶²	Current setpoint shift	Controller extension	1-byte	6,010	C, W, T, (R) ¹

Description 1-byte object used by the extension unit for receiving the current setpoint shift of the room thermostat.
 $x \leq 0 \leq y$ (0 = no shift active); integral numbers
The possible range of values (x to y) is fixed by the setpoint adjusting range to the 'upper limit' or to the 'lower limit' (configurable) in combination with the level value on the room thermostat.

Function: Controller extension

Object	Function	Name	Type	DP type	Flag
 ⁶³	Controller status	Controller extension	1-byte	Not defined	C, W, T, (R) ¹

Description 1-byte object used by the extension unit for receiving the current state of operation of the controller. Status LEDs that can be used to indicate a status independently of a button function can display one of the various information units which are grouped in this byte (bit-oriented evaluation).

Objects for scene function:

Function: Light scene function

Object	Function	Name	Type	DP type	Flag
 ^{66...73}	Switching	Scene output ¹²	1-bit	1,001	C, W, T, (R) ¹

Description 1-bit objects for controlling up to eight actuator groups (ON, OFF).

Function: Light scene function

Object	Function	Name	Type	DP type	Flag
 ^{66...73}	Value	Scene output ¹²	1-byte	5,001	C, W, T, (R) ¹

Description 1-byte objects for controlling up to eight actuator groups (0...255).

1: For readout, the R flag must be set. The last value written to the object via the bus will be read.

2: Scene outputs 2 ... 8 see scene output 1, shift of the object number (66 + number of scene output - 1).

Function: Light scene function

Object	Function	Name	Type	DP type	Flag
 ⁷⁴	Extension unit input	Scene	1-byte	18,001	C, W, -, (R) 1

Description 1-byte object with which one of the eight internally stored scenes can be recalled or stored again.

1: For readout, the R flag must be set. The last value written to the object via the bus will be read.

4.2.4 Functional description

4.2.4.1 Operation concept and button evaluation

Operating areas

The Comfort pushbutton sensor consists of one or more operating areas, depending on the variant. The operation concept of an operating area can be configured in the ETS either as a rocker function or alternatively as a pushbutton function. With the rocker function, one operating area is divided into two neighbouring actuation pressure points with the same basic function. In the pushbutton function either an operating area is divided into 2 functionally separate actuation pressure points (2 buttons), or an operating area is evaluated as single-surface operation (only one large button).

If an operating area is used as a single rocker function, then it is also possible to trigger special functions using full-surface operation.

The number of operating areas depends on the device variant used.

Each operating area has two status LEDs, which, according to the function of the rocker or pushbuttons can be internally connected to the operating function. They may, however, also be used for signalling completely independent functions or be permanently on or off.

The operation LED can also signal the switching state of its own object, flash or be permanently on or off. Besides functions that can be set using the ETS, the operation LED also indicates that the pushbutton sensor is in the programming mode for commissioning or diagnosis purposes.

Moreover, the Comfort pushbutton sensor has functions which are not immediately linked with the rockers or buttons and which must therefore be additionally enabled by the corresponding parameters. These include the thermostat extension function, pushbutton function disable, the internal scenes and the display of alarm signals.

Operating area as rocker function

In the rocker operating concept, two adjacent actuation pressure points are used as a rocker. The two pressure points are then termed the left and right rocker buttons. Pressing the buttons affect the communication objects assigned to the rocker. Usually, pressing both sides of a socket can directly opposite reactions (e.g. switching: left ON - right OFF / Venetian blind: left UP - right DOWN).

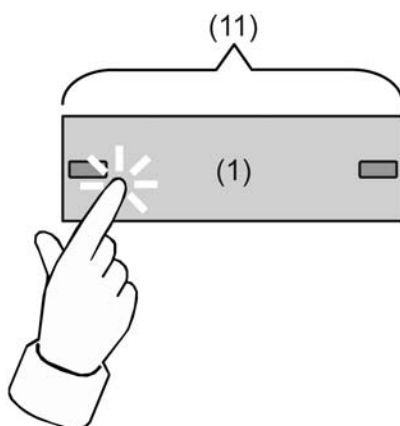

picture 7: Rocker operation, left

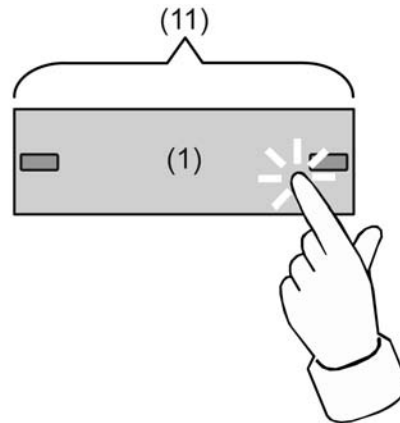

picture 8: Rocker operation, right

- (1) Operating area
- (11) Rocker

Full-surface operation

Depending on the function setting of a rocker, full-surface operation can also be optionally configured. This allows execution of additional functions, separate from the basic rocker function. Full-surface operation is simultaneous operation of both actuation pressure points (left / right) of a rocker.

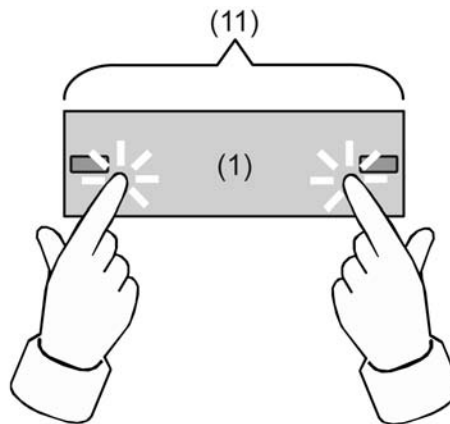

picture 9: Full-surface rocker operation

- (1) Operating area
- (11) Rocker

Operating area as button function

With the pushbutton function, a distinction is made whether the operating area is divided into two separate and functionally independent buttons (double-surface operation), or whether an operating area functions as a single "large" button (single-surface operation). The parameter "Button evaluation" on the parameter page "Operation concept..." configures either double-surface or single-surface operation for each button pair.

In double-surface operation the buttons are configured independently of each other, and can fulfil completely different functions (e.g. switching: TOGGLE – thermostat operating mode: Comfort).

i Full-surface actuation of an operating area is not possible as a pushbutton function.

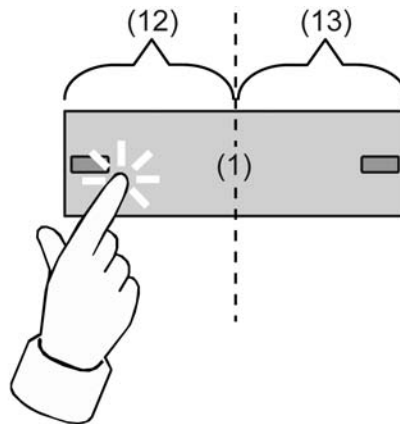

picture 10: Example for button actuation with configured double-surface operation

- (1) Operating area
- (12) Left button of the operating area
- (13) Right button of the operating area

In single-surface operation, the entire operating area is evaluated only as a single "large" button. This button is configured independently of the other buttons or rockers of the pushbutton sensor and can fulfil various functions (e.g. Switching: TOGGLE).

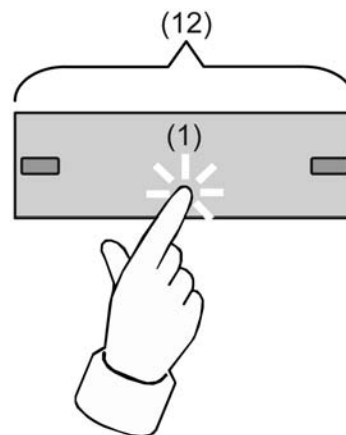

picture 11: Example of button actuation in configured single-surface operation

- (1) Operating area
- (12) Button of the operating area

i With single-surface operation, the operating area can be actuated anywhere.

- i** An operating area is always created in the ETS as a button pair. However, because in single-surface operation only one button functionally exists, the second button of the button pair has no function and is physically not present. During configuration in the ETS it is shown as a "not present" button without any further button parameters. Only the status LED of this button which is physically not used can be configured separately and if needed also activated via its own communication object.
- The physically present button which is to be evaluated in single-surface operation is always created as a button with an uneven button number. If, for example, the first operating area of a pushbutton sensor is configured to single-surface operation, then button 1 can be configured in the ETS. Button 2 is then the physically not present button without parameters.

4.2.4.2 General settings

Operation LED

The operation LED (3) of the Comfort pushbutton sensor is used for different display functions which are in part fixed default functions...

- In a non-programmed device (delivery state) or after downloading of a wrong application program, the operating LED flashes at a slow rate of 0.75 Hz.
- When the pushbutton sensor is switched over into the programming mode for start-up or for ETS diagnosis purposes, the LED flashes at a fast rate of about 8 Hz (see page 8).
- To confirm the detection of a full-surface press with the rocker function, the LED flashes with 8 Hz, too.

The application software allows the setting of addition functions using the ETS parameter "Function of the Operating LED" on the "General" parameter page...

- The operating LED can flash together with all other status LEDs with a frequency of about 2 Hz, when the communication object for the alarm signalling is active.
- The LED can display the status of a separate communication object in inverted or non-inverted form. Here the operation LED can also be activated as flashing with a frequency of approx. 2 Hz.
- For orientation, the operation LED of the pushbutton sensor can be switched permanently on or off.
- It can flash continuously at a slow frequency of about 0.75 Hz.

If several of the above states occur at the same time, the following priority is taken into account:

1. Display of the programming mode.
2. Display of a valid full-surface actuation with the rocker function.
3. Display of an alarm.
4. Status display for the separate communication object or the states (flashing, ON, OFF).

Transmission delay

After a device reset (e.g. after the application program or the physical address is loaded or after the bus voltage is switched on), the pushbutton sensor for the room thermostat extension unit can transmit telegrams automatically. The pushbutton sensor then attempts to retrieve values from the room thermostat by means of read telegrams in order to update the object states.

If in addition to the pushbutton sensor there are still other devices installed in the bus which transmit telegrams immediately after a reset, it may be useful to activate the transmit delay for automatically transmitting objects on the "General" page in order to reduce the bus load.

When transmit delay is activated, the pushbutton sensor determines the value of its individual delay from the device number of its physical address (phys. address: area.line.device number). This value can be about 30 seconds maximum. Without setting a special delay, this principle prevents multiple pushbutton sensors from trying to transmit telegrams to the bus at the same time.

- i** The transmit delay is not active for the rocker and button functions of the pushbutton sensor.

4.2.4.3 Rockers and pushbutton functions

The following contains descriptions of the various functions that can be configured for each rocker or each button of the pushbutton sensor.

4.2.4.3.1 "Switching" function

For each rocker or each button with the function set to "Switching", the ETS indicates a 1-bit communication object. The parameters of the rocker or button permit fixing the value this object is to adopt on pressing and / or on releasing (ON, OFF, TOGGLE – toggling of the object value). No distinction is made between a brief or long press.

The status LEDs can be configured independently (see chapter 4.2.4.4. Status LED).

4.2.4.3.2 "Dimming" function

For each rocker or each button with the function set to "Dimming", the ETS indicates a 1-bit object and a 4-bit object. Generally, the pushbutton sensor transmits a switching telegram after a brief press and a dimming telegram after a long press. In the standard configuration, the pushbutton sensor transmits a telegram for stopping the dimming action after a long press. The time needed by the pushbutton sensor to detect an actuation as a long actuation can be set in the parameters.

The status LEDs can be configured independently (see chapter 4.2.4.4. Status LED).

Single-surface and double-surface operation in the dimming function

In the rocker function, the device is preprogrammed for double-surface operation for the dimming function. This means that the pushbutton sensor transmits a telegram for switching on after a brief press and a telegram for increasing the brightness after a long press ("Brighter"). Similarly, the pushbutton sensor transmits a telegram for switching off after a brief press and a telegram for reducing the brightness after a long press ("Darker").

In the separate buttons function, the device is preprogrammed for single-surface dimming function. In this mode, the pushbutton sensor transmits on each brief press ON and OFF telegrams in an alternating pattern ("TOGGLE"). After a long press, the pushbutton sensor transmits "brighter" and "darker" telegrams in an alternating pattern.

The parameter "Command on pressing the button" or "Command on pressing the rocker" on the parameter pages of the buttons or rockers defines the single-surface or double-surface dimming function.

For the rocker and also for the button function, the command issued on pressing the button or rocker can basically be selected at the user's discretion.

If the actuator can be controlled from several sensors, a faultless single-surface operation requires that the addressed actuator reports its switching state back to the 1-bit object of the button or rocker and that the 4-bit objects of the pushbutton sensors are interlinked. The pushbutton sensor would otherwise not be able to detect that the actuator has been addressed from another sensor, in which case it would have to be actuated twice during the next use in order to produce the desired reaction.

Advanced parameters

For the dimming function, the pushbutton sensor can be programmed with advanced parameters which are hidden in the standard view for greater clarity. If necessary, these advanced parameters can be activated and thus be made visible.

The advanced parameters can be used to determine whether the pushbutton sensor is to cover the full adjusting range of the actuator with one dimming telegram continuously ("Increase brightness by 100 %", "Reduce brightness by 100 %") or whether the dimming range is to be divided into several small levels (50 %, 25 %, 12.5 %, 6 %, 3 %, 1.5%).

In the continuous dimming mode (100%), the pushbutton sensor transmits a telegram only at the beginning of the long press to start the dimming process and generally a stop telegram after the end of the press. For dimming in small levels it may be useful if the pushbutton sensor repeats the dimming telegram in case of a sustained press for a presettable time (parameter "Telegram repetition"). The stop telegram after the end of the press is then not needed.

When the parameters are hidden ("Advanced parameters = deactivated"), the dimming range is set to 100 %, the stop telegram is activated and the telegram repetition is deactivated.

Full-surface operation

When a rocker is used for dimming, the pushbutton sensor needs some time at the beginning of each operation in order to distinguish between a short and a long operation. When the full-surface operation is enabled, the pushbutton sensor can make use of this time span to evaluate

the otherwise invalid simultaneous actuation of both actuation points.

The pushbutton sensor detects a full-surface operation of a rocker, if an operating area is depressed over a large area so that both actuation points of the rocker are actuated. When the pushbutton sensor has detected a valid full-surface actuation, the operation LED flashes quickly at a rate of about 8 Hz for the duration of such actuation. Full-surface operation must have been detected before the first telegram has been transmitted by the dimming function (switching or dimming). If this is not so, even a full-surface operation will be interpreted as a wrong operation and not be executed.

Full-surface actuation is independent. It has a communication object of its own and can optionally be used for switching (ON, OFF, TOGGLE – toggling of the object value) or for scene recall without or with storage function. In the last case, the full-surface actuation causes a scene to be recalled in less than a second. If the pushbutton sensor is to send the telegram for storing a scene, full-surface actuation must be maintained for more than five seconds. If full-surface actuation ends between the first and the fifth second, the pushbutton sensor will not send any telegrams. If the status LEDs of the rocker are used as "button-press displays", they will light up for three seconds during transmission of the storage telegram.

- i Full-surface actuation cannot be configured in the button functions. There it is possible to configure the single-surface principle, which also allows an operating area to be depressed at the centre or over a large area.

4.2.4.3.3 "Blind" function

For each rocker or each button with the function set to "Venetian blind" the ETS indicates the two 1-bit objects "STEP operation" and "MOVE operation".

The status LEDs can be configured independently (see chapter 4.2.4.4. Status LED).

Operation concept for the Venetian blind function

For the control of Venetian blind, roller shutter, awning or similar drives, the pushbutton sensor supports four operation concepts in which the telegrams are transmitted in different time sequences. The pushbutton can therefore be used to operate a wide variety of drive configurations.

The different operation concepts are described in detail in the following chapters.

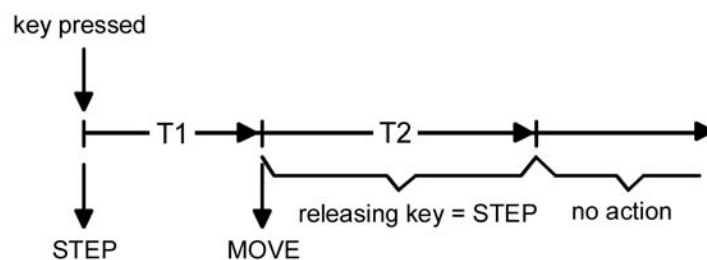

picture 12: Operation concept "short - long - short"

Operation concept "short - long - short":

In the operation concept "short - long - short", the pushbutton sensor shows the following behaviour:

- Immediately on pressing the button, the pushbutton sensor transmits a short time telegram. Pressing the button stops a running drive and starts time T1 ("time between short time and long time command"). If the button is released within T1, no further telegram will be transmitted. This short time serves the purpose of stopping a continuous move. The "time between short time and long time command" in the pushbutton sensor should be selected shorter than the short time operation of the actuator to prevent a jerky movement of the Venetian blind.
- If the button is kept depressed longer than T1, the pushbutton sensor transmits a long time telegram after the end of T1 for starting up the drive and time T2 ("slat adjusting time") is started.
- If the button is released within the slat adjusting time, the pushbutton sensor sends another short time telegram. This function is used for adjusting the slats of a blind. The function permits stopping the slats in any position during their rotation. The "slat adjusting time" should be chosen as required by the drive for a complete rotation of the slats. If the "slat adjustment time" is selected longer than the complete running time of the drive, a pushbutton function is possible as well. This means that the drive is active only when the button is kept depressed.
- If the button is kept depressed longer than T2, the pushbutton sensor transmits no further telegram. The drive remains on until the end position is reached.

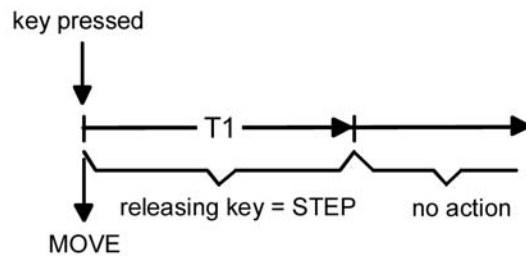

picture 13: Operation concept "long – short"

Operation concept "long – short":

If the operation concept "long – short" is selected, the pushbutton sensor shows the following behaviour:

- Immediately on pressing the button, the pushbutton sensor transmits a long time telegram. The drive begins to move and time T1 ("slat adjusting time") is started.
- If the button is released within the slat adjusting time, the pushbutton sensor transmits a short time telegram. This function is used for adjusting the slats of a blind. The function permits stopping the slats in any position during their rotation. The "slat adjusting time" should be chosen as required by the drive for a complete rotation of the slats. If the "slat adjusting time" is selected longer than the complete running time of the drive, a pushbutton function is possible as well. This means that the drive is active only when the button is kept depressed.
- If the button is kept depressed longer than T1, the pushbutton sensor transmits no further telegram. The drive remains on until the end position is reached.

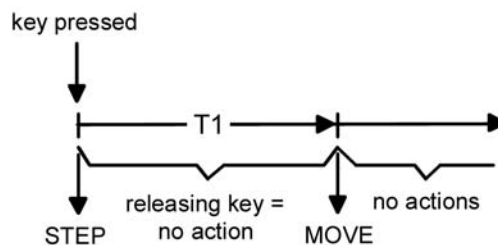

picture 14: Operation concept "short – long"

Operation concept "short – long"

In the operation concept "short – long", the pushbutton sensor shows the following behaviour:

- Immediately on pressing the button, the pushbutton sensor transmits a short time telegram. Pressing the button stops a running drive and starts time T1 ("time between short time and long time command"). If the button is released within T1, no further telegram will be transmitted. This short time serves the purpose of stopping a continuous movement. The "time between short time and long time command" in the pushbutton sensor should be selected shorter than the short time operation of the actuator to prevent a jerky movement of the blind.
- If the button is kept depressed longer than T1, the pushbutton sensor transmits a long time telegram after the end of T1 for starting the drive.
- No further telegram is transmitted when the button is released. The drive remains on until the end position is reached.

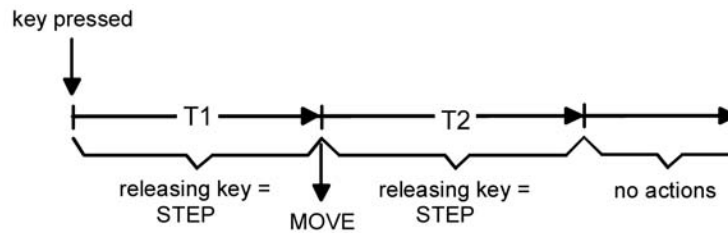

picture 15: Operation concept "long – short or short"

Operation concept "long – short or short":

In the operation concept "long – short or short", the pushbutton sensor shows the following behaviour:

- Immediately on pressing the button, the pushbutton sensor starts time T1 ("time between short time and long time command") and waits. If the button is released again before T1 has elapsed, the pushbutton sensor transmits a short time telegram. This telegram can be used to stop a running drive. A stationary drive rotates the slats by one level.
 - If the button is kept depressed after T1 has elapsed, the pushbutton sensor transmits a long time telegram and starts time T2 ("slat adjusting time").
 - If the button is released within T2, the pushbutton sensor sends another short time telegram. This function is used for adjusting the slats of a blind. The function permits stopping the slats in any position during their rotation. The "slat adjusting time" should be chosen as required by the drive for a complete rotation of the slats. If the "slat adjusting time" is selected longer than the complete running time of the drive, a pushbutton function is possible as well. This means that the drive is active only when the button is kept depressed.
 - If the button is kept depressed longer than T2, the pushbutton sensor transmits no further telegram. The drive remains on until the end position is reached.
- i** In this operation concept, the pushbutton sensor will not transmit a telegram immediately after depressing one side of the rocker. This principle permits detecting a full-surface operation when the sensor is configured as a rocker.

Single and double-surface Venetian blind function

With an operating area as a rocker, the double-surface Venetian blind function is preset. This means that the pushbutton sensor transmits a telegram for an upward movement, for example after an actuation of the left actuation point and a telegram for a downward movement after an actuation of the right actuation point.

In the separate buttons function, the device is preprogrammed for single-surface Venetian blind function. In this case, the pushbutton sensor alternates between the directions of the long time telegram (TOGGLE) on each long actuation of the sensor. Several short time telegrams in succession have the same direction.

The parameter "Command on pressing the button" or "Command on pressing the rocker" on the parameter pages of the buttons or rockers defines the single-surface or double-surface Venetian blind principle. For the button function, the command issued on pressing the button can basically be selected at the user's discretion.

If the actuator can be controlled from several sensors, a faultless single-surface actuation requires that the long time objects of the pushbutton sensors are interlinked. The pushbutton sensor would otherwise not be able to detect that the actuator has been addressed from another sensor, in which case it would have to be actuated twice during the next use in order to produce the desired reaction.

Full-surface operation with Venetian blind function

When a rocker is configured for Venetian blind operation and if the operation concept "long – short or short" is used, the pushbutton sensor needs some time at the beginning of each operation in order to distinguish between a short and a long operation. When the full-surface operation is enabled, the pushbutton sensor can make use of this time span to evaluate the

otherwise invalid simultaneous actuation of both actuation points.

The pushbutton sensor detects a full-surface operation of a rocker, if an operating area is depressed over a large area so that both actuation points of the rocker are actuated. When the pushbutton sensor has detected a valid full-surface actuation, the operation LED flashes quickly at a rate of about 8 Hz for the duration of such actuation. Full-surface operation must have been detected before the first telegram has been transmitted by the Venetian blind function (short time or long time). If this is not so, even a full-surface operation will be interpreted as a wrong operation and not be executed.

Full-surface actuation is independent. It has a communication object of its own and can optionally be used for switching (ON, OFF, TOGGLE – toggling of the object value) or for scene recall without or with storage function. In the last case, the full-surface actuation causes a scene to be recalled in less than a second. If the pushbutton sensor is to send the telegram for storing a scene, full-surface actuation must be maintained for more than five seconds. If full-surface actuation ends between the first and the fifth second, the pushbutton sensor will not send any telegrams. If the status LEDs of the rocker are used as "button-press displays", they will light up for three seconds during transmission of the storage telegram.

- i Full-surface actuation cannot be configured in the button functions. There it is possible to configure the single-surface principle, which also allows an operating area to be depressed at the centre or over a large area.

4.2.4.3.4 "Value transmitter" function

For each rocker or each button with the function set to "1-byte value transmitter" or "2-byte value transmitter", the ETS indicates a corresponding object. On the press of a button, the configured value or the value last stored internally by a value change (see below) will be transmitted to the bus. In case of the rocker function, different values can be configured or varied for both actuation points.

The status LEDs can be configured independently (see chapter 4.2.4.4. Status LED).

Value ranges

The "Function" parameter determines the value range used by the pushbutton.

As a 1-byte value transmitter, the pushbutton sensor can optionally transmit integers from 0 ... 255 or relative values within a range of 0 ... 100 % (e.g. as dimming value transmitter).

As a 2-byte value transmitter, the pushbutton sensor can optionally transmit integers from 0 ... 65535, temperature values within a range of 0 ... 40 °C or brightness values from 0 ... 1500 lux.

For each of these ranges, the value that can be transmitted to the bus for each actuation of a rocker or button is configurable.

Adjustment by means of long button-press

If the value adjustment feature has been enabled in the ETS, the button must be kept depressed for more than 5 seconds in order to vary the current value of the value transmitter. The value adjustment function continues to be active until the button is released again. In a value adjustment, the pushbutton sensor distinguishes between the following options...

- The "Starting value in case of value adjustment" parameter defines the original starting value for the adjustment. Adjustment can begin from the value configured in the ETS, from the final value of the last adjustment cycle or from the current value of the communication object, with the last option not being available for the temperature and brightness value transmitter.
- The parameter "Direction of value adjustment" defines whether the values will always be increased ("upwards"), always reduced ("downwards") or alternately increased and reduced ("toggling").
- For the value transmitters 0 ... 255, 0 ... 100 % and 0 ... 65535, the "level size" by which the current value is to be changed during the value adjustment can be specified. In case of the temperature and the brightness value transmitter, the level size specifications (1 °C and 50 lux) are fixed.
- The parameter "Time between two telegrams" can be used in conjunction with the level size to define the time required to cycle through the full respective value range. This value defines the time span between two value transmissions.
- If, during the value adjustment, the pushbutton sensor detects that the preset level size would result in the limits being exceeded with the next telegram, it adapts the level size once in such a way that the respective limit value is transmitted together with last telegram. Depending on the setting of the parameter "Value adjustment with overflow", the pushbutton sensor stops the adjustment at this instance or inserts a pause consisting of two levels and then continues the adjustment beginning with the other limit value.

	Function	Lower numerical limit	Upper numerical limit
1-byte value transmitter	0...255	0	255
1-byte value transmitter	0...100 %	0 % (value = 0)	100 % (value = 255)
2-byte value transmitter	0...65535	0	65535
2-byte value transmitter	Temperature value	0 °C	40 °C
2-byte value transmitter	Brightness value	0 Lux	1,500 lux

Table 1: Value range limits for the different value transmitters

- i** During a value adjustment, the newly adjusted values are only in the volatile RAM memory of the pushbutton sensor. Therefore, the stored values are replaced by the preset values programmed in the ETS when a reset of the pushbutton sensor occurs (bus voltage failure or ETS programming).
- i** With the 1-byte value transmitter in the "Value transmitter 0...100 %" function, the level size of the adjustment will also be indicated in "%". If the starting value of the communication object is used, it may happen in this case during value adjustment that the value last received via the object must be rounded and adapted before a new value can be calculated on the basis of the level size and transmitted. Due to the computation procedure used, the new calculation of the value may be slightly inaccurate.

Value adjustment examples

Configuration example:

- Value transmitter 1-byte (all other value transmitters identical)
- Function = value transmitter 0...255
- Value configured in the ETS (0...255) = 227
- Level size (1...10) = 5
- Start on value adjustment = same as configured value
- Direction of value adjustment = switchover (alternating)
- Time between two telegrams = 0.5 s

Example 1: Value adjustment with overflow? = No

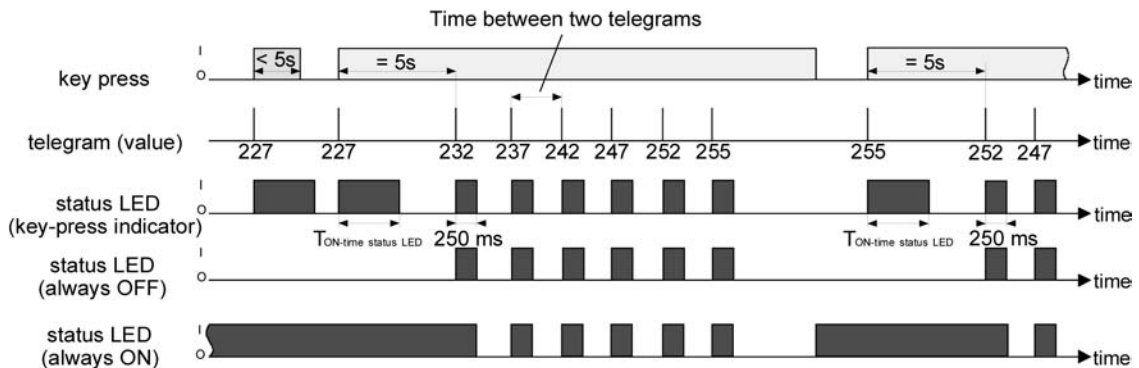

picture 16: Example of value adjustment without value range overflow

Example 2: Value adjustment with overflow? = Yes

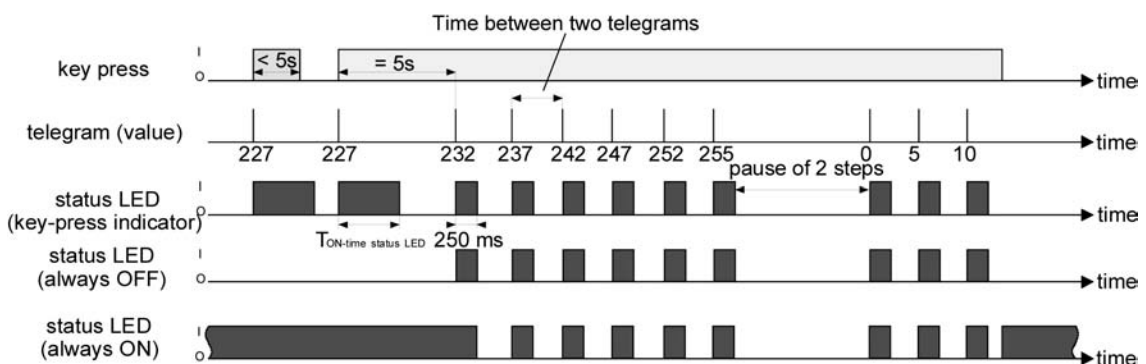

picture 17: Example of value adjustment with value range overflow

4.2.4.3.5 "Scene extension" function

For each rocker or each button with the function set to "scene extension" the ETS indicates the "Function" parameter which distinguishes between the settings...

- "Scene extension without storage function",
- "Scene extension with storage function",
- "Recall of internal scene without storage function",
- "Recall of internal scene extension with storage function".

In the scene extension function, the pushbutton sensor transmits a preset scene number (1...64) via a separate communication object to the bus after a button-press. This feature permits recalling scenes stored in other devices and also storing them, if the storage function is used.

The recall of an internal scene does not result in a telegram being transmitted to the bus. For this reason, the corresponding communication object is missing. This function can rather be used to recall – and with the storage function also to store – the up to 8 scenes stored internally in the pushbutton sensor.

In the setting "... without storage function", a button-press triggers the simple recall of a scene. If the status LED is configured as button-press display, it will be switched on for the configured ON time. A long button-press has no further or additional effect.

In the setting "... with storage function", the pushbutton sensor monitors the length of the actuation. A button-press of less than a second results in a simple recall of the scene as mentioned above. If the status LED is configured as button-press display, it will be switched on for the configured ON time.

After a button-press of more than five seconds, the pushbutton sensor generates a storage instruction. In the scene extension function, a storage telegram is in this case transmitted to the bus. If configured for the recall of an internal scene, the sensor will store the internal scene. The internal scene control module of the Universal TSM pushbutton sensor will then request the current scene values for the actuator groups used from the bus (see chapter 4.2.4.5. Scene control).

An actuation lasting between one and five seconds will be discarded as invalid.

The parameter "Scene number" specifies which of the maximum of 8 internal or 64 external scenes is to be used after a button-press. In case of the rocker function, two different scene numbers can be assigned.

The status LEDs can be configured independently (see chapter 4.2.4.4. Status LED).

4.2.4.3.6 "2-channel operation" function

In some situations it is desirable to control two different functions with a single button-press and to transmit different telegrams, i.e. to operate two function channels at a time. This is possible with the "2-channel operation" function.

For both channels, the parameters "Function channel 1" and "Function channel 2" can be used to determine the communication object types to be used. The following types are available for selection...

- Switching (1 bit)
- Value transmitter 0 ... 255 (1-byte)
- Value transmitter 0 ... 100 % (1-byte)
- Temperature value transmitter (2 bytes)

The object value the pushbutton sensor is to transmit on a button-press can be selected depending on the selected object type. The "Switching (1 bit)" type permits selecting whether an ON or an OFF telegram is to be transmitted or whether the object value is to be switched over (TOGGLE) and transmitted on the press of a button.

The configuration as "Value transmitter 0 ... 255 (1 byte)" or as "Value transmitter 0 ... 100 % (1 byte)" permits entering the object value freely within a range from 0 to 255 or from 0% to 100%. The "Temperature value transmitter (2 bytes)" permits selecting a temperature value between 0°C and 40°C.

In this case, the adjustment of the object value on a long button-press is not possible as the determination of the actuation length is needed for the adjustable operation concepts. Unlike in the other rocker and button functions, the application software assigns the "Telegram acknowledge" function instead of the "Button-press display" function to the status LED. In this mode, the status LED lights up for approx. 250 ms with each telegram transmitted. Alternatively, the status LEDs can be configured independently (see chapter 4.2.4.4. Status LED).

Operation concept channel 1 or channel 2

In this operation concept, exactly one telegram will be transmitted on each press of a button.

- On a brief press the pushbutton sensor transmits the telegram for channel 1.
- On a long press the pushbutton sensor transmits the telegram for channel 2.

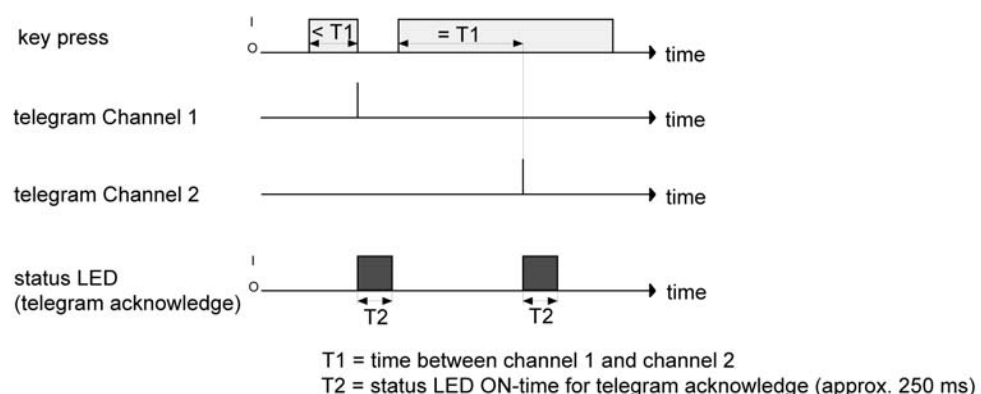

picture 18: Example of operation concept "Channel 1 or Channel 2"

The time required for distinguishing between a short and a long actuation is defined by the parameter "Time between channel 1 and channel 2". If the button is pressed for less than the configured time, only the telegram to channel 1 is transmitted. If the length of the button-press exceeds the time between channel 1 and channel 2, only the telegram to channel 2 will be transmitted. This concept provides the transmission of only one channel. To indicate that a

telegram has been transmitted, the status LED lights up for approx. 250 ms in the "Telegram acknowledge" setting.

In this operation concept, the pushbutton sensor will not transmit a telegram immediately after the rocker has been depressed. This principle also permits the detection of full-surface operation. The settings that are possible with full-surface operation are described below.

Operation concept channel 1 and channel 2

With this operation concept, one or alternatively two telegrams can be transmitted on each button-press.

- On a brief press the pushbutton sensor transmits the telegram for channel 1.
- A long press causes the pushbutton sensor to transmit first the telegram for channel 1 and then the telegram for channel 2.

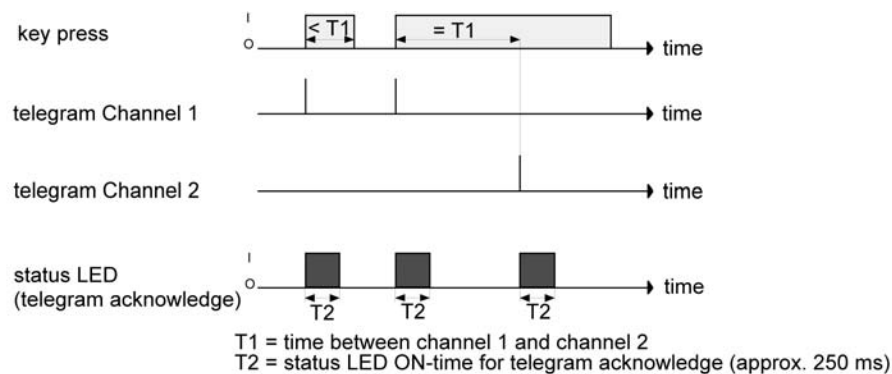

picture 19: Example of operation concept "Channel 1 or Channel 2"

The time required for distinguishing between a short and a long actuation is defined by the parameter "Time between channel 1 and channel 2". In this operation concept, a button-press sends this telegram immediately to channel 1. If the button is held depressed for the configured time, the telegram for the second channel is transmitted as well. If the button is released before the time has elapsed, no further telegram will be transmitted. This operation concept, too, offers the configurable possibility of having the transmission of a telegram signalled by the status LED (setting "Telegram acknowledge").

Full-surface operation with 2-channel operation

When a rocker is programmed for 2-channel operation and if the operation concept "channel 1 or channel 2" is used, the pushbutton sensor needs some time at the beginning of each operation in order to distinguish between a short and a long operation. When full-surface operation is enabled, the pushbutton sensor can make use of this time span to evaluate the otherwise invalid simultaneous actuation of both actuation points.

The pushbutton sensor detects a full-surface operation of a rocker, if an operating area is depressed over a large area so that both actuation points of the rocker are actuated. When the pushbutton sensor has detected a valid full-surface actuation, the operation LED flashes quickly at a rate of about 8 Hz for the duration of such actuation. The full-surface operation must have been detected before the first telegram has been transmitted by the 2-channel function. If this is not so, even a full-surface operation will be interpreted as a wrong operation and not be executed.

4.2.4.4 Status LED

Status LED

Each operating area on the pushbutton sensor has two status LEDs. The functions available differ slightly depending on the configuration of the rockers or buttons.

Each status LED distinguishes the following options...

- Always OFF,
- Always ON,
- Activation via separate LED object,
- Operating mode display (KNX controller),
- Controller status indicator (activate controller extension!),
- Comparator without sign (1 byte),
- Comparator with sign (1 byte).

These options are always available even if the buttons have no function assigned.

If a function has been assigned to the rocker or button, the ETS displays moreover the option...

- Button-press display

...which in the function "2-channel operation" is replaced by...

- Telegram acknowledgment

If the rocker or the button is used for switching or dimming, the following options can be selected in addition...

- Status display (switching object)
- Inverted status display (switching object)

...can be set.

If a button is used for the operation of a controller extension, the following options can be selected in addition...

- button function active / inactive indicator (only with presence button),
- setpoint value shift indicator (only with setpoint shift).

...can be set.

i Besides the functions that can be set separately for each status LED, all status LEDs are also used together with the operation LED for alarm signalling. If this is active, all LEDs of the pushbutton sensor flash simultaneously. After deactivation of the alarm signalling, all LEDs will immediately return to the state corresponding to their configuration and communication objects.

Status LED function "always OFF" or "always ON"

A status LED used as button-press display is switched on by the sensor each time the corresponding rocker or button is pressed. The parameter "ON time of status LEDs as actuation indicators" on the parameter page "General" specifies for how long the LED is switched on in common for all status LEDs. The status LED lights up when the rocker or button is pressed even if the telegram is transmitted by the sensor only when the button or rocker is released. With the function "2-channel operation" the option "Button-press display" is replaced by "Telegram acknowledge". In this case the status LED is illuminated when both channels are transmitted for about 250 ms each.

Function of the status LED "Activation via separate LED object", "Status display", and "Inverted status display"

Each status LED can indicate the status of a separate LED communication object independently of the rocker or pushbutton configuration. Here the LED can be switched on or off statically via the received 1-bit object value, or also activated by flashing. Each status LED can indicate the state of a separate LED communication object independently of the rocker or pushbutton configuration. Here the LED can be switched on or off statically via the 1-bit object value received, or also activated as flashing.

Additionally, the status LEDs can be linked in the rocker or button functions "switching" and "dimming" also with the object used for switching and thus signal the current switching state of the actuator group.

Both for the status indication of the LED object and also for the status indication of the switching object it is possible to indicate or evaluate the inverted object value.

After a bus reset or after ETS programming, the value of the LED object is always "OFF".

Function of status LED as "operating mode display (KNX controller)"

For switching over between different modes of operation, new room thermostats can make use of two communication objects of the 20.102 "HVAC-Mode" data type. One of these objects can switch over with normal priority between the "Comfort", "Standby", "Night", "Frost/heat protection" operating modes. The second object has a higher priority. It permits switching over between "Automatic", "Comfort", "Standby", "Night", "Frost/heat protection". Automatic means in this case that the object with the lower priority is active.

If a status LED is to indicate the operating mode, the communication object of the status LED must be linked with the matching object of the room thermostat. The desired mode which the LED is to indicate can then be selected with the parameter "Status LED on with". The LED is then lit up when the corresponding mode of operation has been activated at the controller.

After a bus reset or after ETS programming, the value of the LED object is always "0" (Automatic).

Function of status LED as "controller status display"

If a status LED is to indicate the status of a room thermostat, the thermostat extension must have been activated on parameter page "General". The status LED is then internally linked directly with the 1-byte object "Controller status" of the controller extension. This object must then be linked via a group address with the corresponding communication object of the controller.

The object "Controller status" groups eight different information units in a bit-oriented way in a byte. For this reason it is important to select in the "Status LED on with" parameter which information is to be indicated, i.e. which bit is to be evaluated.

The following can be selected...

- Bit 0: Comfort mode
- Bit 1: Standby mode
- Bit 2: Night mode
- Bit 3: Frost/heat protection
- Bit 4: Controller disabled
- Bit 5: Heating / cooling (heating = 1 / cooling = 0)
- Bit 6: Controller inactive (dead zone operation)
- Bit 7: Frost alarm

Description of bit-oriented status messages of the room thermostat (active = ON)

Comfort mode: Active if operating mode "Comfort" or a comfort extension is activated.

Standby mode: Active if the "Standby" operating mode is activated.

Night mode: Active if the "Night" operating mode is activated.

Frost/heat protection: Active if the "Frost/heat protection" operating mode is activated.

Controller disabled: Active if controller disable is activated (dew point mode).

Heating/cooling: Active if heating is activated and inactive if cooling is activated. (As a rule inactive with controller disabled.)

Controller inactive: Active with the "heating and cooling" operating mode when the measured room temperature lies within the dead zone. This status information is as a rule always "0" for the individual operating modes "heating" or "cooling"! (Inactive if controller is disabled.)

Frost alarm: Active if the measured room temperature reaches or drops below + 5 °C.

The communication object "Controller status" of the controller extension updates itself automatically after a reset of the pushbutton sensor or after ETS programming, if the parameter "Value request from controller extension?" on parameter page "General" is set to "Yes". Updating is effected by means of a value read telegram to the room thermostat. The thermostat must answer the request with a value return telegram. If the pushbutton sensor does not receive the answer, the status LED remains off (object value "0"). In this case, the object must first be actively rewritten by the bus after a reset before a status information can be indicated by the LED.

This is also the case, when the "Value request from controller extension?" is set to "No".

Function of status LED as "comparator"

The status LED can indicate whether a configured comparison value is greater than, equal to or less than the 1-byte object value of the status object. This comparator can be used for unsigned (0 ... 255) or for signed integers (-128 ... 127). The data format of the comparison is defined by the function of the status LED.

The status LED lights up only if the comparison is "true".

i After a bus reset or after ETS programming, the value of the LED object is always "0".

4.2.4.5 Scene control

Introduction

The pushbutton sensor can be used in two different ways as part of a scene control system...

- Each rocker or button can work as a scene extension. This feature makes it possible to recall or to store scenes which may be stored in other devices (see chapter 4.2.4.3.5. "Scene extension" function).
- The pushbutton can independently store up to eight scenes with eight actuator groups. These internal scenes can be recalled or stored by the rockers or buttons (internal scene recall) and also by the communication object "scene extension".
In the following subsections the internal scene function will be dealt with in greater detail.

4.2.4.5.1 Scene definition and scene recall

If the internal scenes are to be used, the parameter "Scene function" on parameter page "Scenes" must be set to "Yes". When the scene function is activated, the ETS automatically renames the "Scenes" page "Scene data types".

The matching data types for the eight scene outputs must then be selected and adapted to the actuator groups used. The types "Switching", "Value (0 ... 255)" or "Value / blind position (0 ... 100 %)" can be selected. As a rule, Venetian blinds are controlled via two scene outputs. One output controls the blind height and the other one adjusts the slat position.

The ETS sets the corresponding communication objects and the parameters of the scene commands on the following parameter pages "Scene 1" to "Scene 8".

It is possible that the values for the individual scenes preset by the parameters are modified later on with the storage function (see chapter 4.2.4.5.2. Storing scenes) when the system is in operation. If the application program is then loaded again with the ETS, these locally adapted values will normally be overwritten by the parameters. Due to the fact that it may take considerable efforts to readjust the values for all scenes in the system, the parameter "Overwrite scene values during ETS download ?" offers the possibility of retaining the scene values stored in operation without overwriting them.

The scene parameters can be set on the parameter page of each individual scene ("Scene 1 ... 8"). The setting options are the same for all 8 scenes.

These internal scenes can be recalled directly via the rockers or buttons (function "recall internal scene") and also by another bus device via the "Extension input" communication object. This 1 byte communication object supports the evaluation of up to 64 scene numbers. For this reason, it must be specified in ETS which of the external scene numbers (1 ... 64) is to recall the internal scene (1 ... 8). If the same scene number is listed for several internal scenes, it is always only the first of these scenes that will be activated (scene with the lowest scene number).

In some situations there may be the requirement that a group of actuators is not controlled by all, but only by certain scenes. A classroom, for instance, may require open blinds for the "Welcome" and "Break" scenes, closed blinds in the "PC presentation" scene and no change in the "Discussion" scene. In this example, the parameter "Permit transmission ?" can be set to "No" for the "Discussion" scene. The scene output is then deactivated during the corresponding scene.

The parameter "Transmit delay" permits entering an individual waiting time for each scene output. This transmit delay can be used in different situations...

- When the actuators participating in a scene transmit status messages automatically or when several scene buttons are used to increase the number of channels within the scenes, the recall of a scene may result for a short time in high bus loading. The transmit delay helps to reduce the bus load at the time of scene recall.
- Sometimes, it is desirable that an action is started only after another action has ended. This can be for instance the lighting which is to shut off only after the blinds/shutters have been raised.

The transmit delay can be set separately for each scene output. The transmit delay defines the time between the individual telegrams during a scene recall. The setting specifies how much time must pass after the first scene telegram before the second is transmitted. After transmission of the second scene telegram, the configured time must again pass before the third is transmitted. The delay continues as follows for each additional scene telegram. The transmit delay for the first scene telegram starts immediately after the scene has been recalled. The transmit delay between telegrams can also be deactivated (setting "0"). The telegrams are then transmitted at the shortest possible time interval. In this case, however, the order of the telegrams transmitted can deviate from the numbering of the scene outputs.

- i** When a new scene recall (also with the same scene number) occurs during a current scene recall - even in consideration of the pertaining transmit delays - the scene processing started first will be aborted and the newly received scene number will be processed. A running scene is also aborted when a scene is being stored!
- i** During a scene recall - even if delayed - the operating areas of the push button sensor are normally operational.

4.2.4.5.2 Storing scenes

For each output of a scene, the user can define a corresponding scene value in the ETS which is then transmitted to the bus during a scene recall. During the regular operation of the system it may be required to adapt these preset values and to store the adapted values in the pushbutton sensor. This can be ensured by the storage function of the scene control.

The value storage function for the corresponding scene number is enabled with the parameter "Permit storing ?" ("Yes") or disabled ("No"). When the storage function is disabled, the object value of the corresponding output is not sampled during storage.

A scene storage process can be initiated in two different ways...

- by a long press on a rocker or button of an operating area configured as "scene extension"
- by a storage telegram to the extension object.

During a storage process, the pushbutton sensor reads the current object values of the connected actuators. This is carried out by means of eight read telegrams (ValueRead) addressed to the devices in the scene which return their own value (ValueResponse) as a reaction to the request. The returned values are received by the pushbutton sensor and taken over permanently into the scene memory. Per scene output, the pushbutton sensor waits one second for a response. If no answer is received during this time, the value for this scene output remains unchanged and the pushbutton sensor scans the next output.

In order to enable the pushbutton sensor to read the object value of the actuator addressed when a scene is stored, the read flag of the corresponding actuator object must be set. This should be done only for one actuator out of an actuator group so that the value response is unequivocal.

The stored values overwrite those programmed into the pushbutton sensor with the ETS.

The storage process will always be executed completely by the pushbutton sensor and cannot be aborted before it has ended. Recalling scenes in the course of a storage process is not possible, the operating areas of the pushbutton sensor remaining nevertheless normally operational.

4.2.4.6 Disabling function

Configuration

With the 1-bit communication object "Key disabling", the operating areas of the pushbutton sensor can be partly or completely disabled. During a disable, the rockers or buttons can also temporarily execute other functions.

An active disable applies only to the functions of the rockers or buttons. The functions of the status LED, scene function and the alarm signalling are not affected by the disabling function. The disabling function and the pertaining parameters and communication objects are enabled if the parameter "Disabling function ?" is set to "Yes" on the "Disabling" parameter page.

The polarity of the disabling object can be configured. In case of polarity inversion (disabled = 0 / enabled = 1), the disabling function is not activated immediately after a bus reset or after ETS programming (object value = "0"). There must first be an object update "0" until the disabling function will be activated.

Telegram updates from "0" to "0" or from "1" to "1" on the "button disabling" object remain without effect.

Configuring the reaction at the beginning and end of a disable

If the disabling function is used, the reaction of the pushbutton sensor on activation and deactivation of the disabling function can be preset separately in the parameters of the pushbutton sensor (parameter "Reaction of pushbutton sensor at the beginning / end of disabling"). In this connection it is irrelevant which of the operating areas is influenced and possibly also locked by disabling. The pushbutton sensor always shows the configured behaviour.

The disabling function must have been enabled in advance.

- Set the parameter "Reaction of pushbutton sensor at the beginning / end of disabling" to "No reaction".

The pushbutton sensor shows no reaction at the beginning and at the end of disabling. The sensor only adopts the state as provided for by the "Behaviour during active disabling".

- Set the parameter "Reaction of pushbutton sensor at the beginning / end of disabling" to "Internal scene recall scene 1 ...8".

The pushbutton sensor recalls one of the up to 8 internal scenes. Scene storage is not possible.

- Set the parameter "Reaction of pushbutton sensor at the beginning / end of disabling" to "Reaction as button >> X << / >> Y << when pressed / released".

The pushbutton sensor executes the function assigned to any "target button" in non-disabled state. Target buttons are operating buttons of the pushbutton sensor which may be configured for rocker or for button operation. The target buttons are configured separately for the beginning (X) or for the end (Y) of disabling. Both buttons of a rocker are treated as two separate buttons.

The action configured for the respective target button is executed. If the target button is configured in such a way that it has no function or does not transmit a telegram on pressing or releasing of the button, then there is also no reaction to disabling or to re-enabling. If the selected target button is part of a configured rocker, the behaviour preset for the respective rocker side (rocker X.1 or X.2) will be used. The telegrams are transmitted to the bus via the required communication object of the target button.

The following table shows all possible telegram reactions of the pushbutton sensor with respect to the target button function.

Function of >>target button<<	Reaction "as >>target button<< on pressing"	Reaction "as >>target button<< on releasing"
Switching / switchover	Switching telegram	Switching telegram
Dimming	Switching telegram	No telegram
Venetian blind	Move telegram	No telegram
Scene extension	Scene recall telegram	No telegram
1-byte value transmitter	Value telegram	No telegram
2-byte value transmitter	Value telegram	No telegram
Temperature value transmitter	Temperature value telegram	No telegram
Brightness value transmitter	Brightness value telegram	No telegram
2-channel operation Channel 1: 1-bit object type	Switching telegram	No telegram
2-channel operation Channel 1: 1-byte object type	Value telegram	No telegram
2-channel operation Channel 1: 2-byte object type	Temperature value telegram	No telegram
Controller extension Operating mode switchover	Operating mode telegram	No telegram
Controller extension Motion detection	Presence telegram	No telegram
Controller extension Setpoint shift	Level value telegram	No telegram
No function	No telegram	No telegram

Table 2: Telegram reactions of the pushbutton sensor with respect to the target button function

- Set the parameter "Reaction of pushbutton sensor at the beginning / end of disabling" to "Reaction as disabling function 1 / 2 when pressed / released".

The pushbutton sensor executes the function assigned to either of the two "virtual" disabling functions. The disabling functions are internal button functions with independent communication objects and independent parameters. Except for the status LED, the setting possibilities available for disabling function 1 and disabling function 2 are the same as for the buttons.

The respective configuration of the predefined disabling function will be executed. If no function or no telegram is configuration in the disabling function on pressing or releasing of a button, then there is also no reaction to disabling or to re-enabling.

Also, for this setting, Table 2 shows all possible telegram reactions of the pushbutton sensor depending on the configuration of the disabling function.

The telegrams are transmitted to the bus via the required communication object of the disabling function.

Configuring the reaction during a disable

Irrespective of the behaviour shown by the pushbutton sensor at the beginning or at the end of disabling, the control buttons can be separately influenced during disabling.

The disabling function must have been enabled in advance.

- Set the parameter "Behaviour during active disabling" to "All buttons without function".

In this case, the pushbutton sensor is completely disabled during disabling. Pressing a button has no effect. The status LEDs of the disabled buttons are without function (no button-press display either). Only the "Always ON" or "Always OFF" state remains unaffected by the disabling function.

- Set the parameter "Behaviour during active disabling" to "all buttons behave like". Continue to configure the parameters "During disable, all left / right buttons behave like" to the required button number or disabling function.

All buttons behave as defined in the parameters for the two specified reference buttons of the pushbutton sensor. Different or identical reference buttons can be configured separately for all the left and right operating buttons. The two "virtual" disabling functions of the pushbutton sensor can also be configured as a reference button.

The telegrams are transmitted to the bus via the communication objects of the specified reference buttons. The status LEDs of the reference buttons are controlled according to their function. The status LEDs of the disabled buttons are without function (no button-press display either). Only the "Always ON" or "Always OFF" state remains unaffected by the disabling function.

- Set the parameter "Behaviour during active disabling" to "Individual buttons without function". The buttons that will be disabled are defined on the parameter page "Disable - Button selection" page.

Only the individually specified buttons are locked during disabling. The other control buttons remain unaffected by disabling. The status LEDs of the disabled buttons are without function (no button-press display either). Only the "Always ON" or "Always OFF" state remains unaffected by the disabling function.

- Set the parameter "Behaviour during active disabling" to "Individual buttons behave like". The buttons that will be disabled are defined on the parameter page "Disable - Button selection" page. Also set the parameters "All buttons with even / odd numbers behave during disabling like" to the desired button number or disabling function.

Only the individually specified buttons behave as defined in the parameters of the two specified reference buttons of the pushbutton sensor. Different or identical reference buttons can be configured separately for all the left and right operating buttons. The two "virtual" disabling functions of the pushbutton sensor can also be configured as a reference button. The buttons that will be disabled are defined in the parameters on the "Disable - buttons selection" page.

The telegrams are transmitted to the bus via the communication objects of the specified reference buttons. The status LEDs of the reference buttons are controlled according to their function. The status LEDs of the disabled buttons are without function (no button-press display either). Only the "Always ON" or "Always OFF" state remains unaffected by the disabling function.

- i** If a button evaluation is taking place at the time of activation / deactivation of a disabling function, this function is aborted immediately and with it also the pertaining button function. It is first necessary to release all buttons before a new button function can be executed if so permitted by the state of disabling.

4.2.4.7 Controller extension

4.2.4.7.1 Connection to room thermostat

Function

The controller extension can be used to control a KNX/EIB room thermostat. The controller extension function is enabled with the parameter "Controller extension" on the "General" page

The controller extension itself is not involved in the regulating process. With it, the user can operate the single-room regulation from different places in the room. It can also be used to adjust central heating control units which are located, for instance, in a distribution box.

Typical KNX/EIB room thermostats generally offer different ways of influencing or visualising the room temperature control...

- Switching over between different modes of operation (e.g. "Comfort", "Night" ...) with different setpoint temperatures assigned to each mode by the thermostat.
- Signalling the presence of a person in a room. The signalling may also be combined with a configured switchover in the mode of operation.
- Readjustment of the setpoint temperature in steps which are referred in each case to the configured setpoint temperature of the current mode of operation (basic setpoint shift).

The pushbutton sensor permits, by means of its control keys, the complete control of a room thermostat by changing the operating mode, by predefining the presence situation or by readjusting the setpoint shift. For this purpose, the buttons of the pushbutton sensor selected as extension operation buttons must be configured for the "Controller extension" function.

- i** It should be noted that an extension operation is possible only if one control surface is configured as a button and if the controller extension function has been enabled on the "General" page. In all other cases, controller extension operating does not function.

In addition, the pushbutton sensor can – independent of the controller extension function – indicate the state of one or more room thermostats with the status LEDs of the rockers or buttons. This feature permits the indication of modes of operation or the bit-oriented evaluation of different status objects of controllers (see chapter 4.2.4.4. Status LED). In case of the controller extension functions "Setpoint shift" or "Presence function", the status LEDs can also signal the state of the corresponding functions directly.

Communication objects

The controller extension can work properly only if all extension objects are linked with the objects of the same function in the room thermostat. The controller extension with the objects exists only once in the pushbutton sensor (indication in the object name "Controller extension"). All button functions configured for the controller extension act on the objects belonging to the extension.

Objects with the same function can be linked together using identical group addresses, meaning that multiple controller extensions can affect one main controller.

The communication objects "Operating mode selection", "Forced operating mode switchover", "Presence button", "Current setpoint shift" and "Controller status" of the controller extension update themselves automatically after a reset of the pushbutton sensor or after ETS programming, if the parameter "Value request from controller extension?" on the "General"

parameter page is set to "Yes". Updating is effected by means of a ValueRead telegram to the room thermostat. This must answer the request with a ValueResponse telegram. If the pushbutton sensor does not receive all or some of the answers, the affected objects are initialised with "0". In this case, the objects must first be actively rewritten by the bus after a reset. This is also the case, when the "Value request from controller extension?" is set to "No".

4.2.4.7.2 Button function "Operating mode switchover"

Switchover of the controller operating mode can be effected in accordance with the standard function block for room thermostats defined in the KNX handbook with two 1-byte communication objects. The operating mode can be switched over with the normal and with the forced objects. The "Operating mode selection" object offers a selection between the following operating modes...

- Comfort mode
- Standby mode
- Night mode
- Frost / heat protection

The "Forced operating mode switch over" communication object has a higher priority. It permits forced switching between the following modes of operation...

- Auto (normal operating mode switchover)
- Comfort mode
- Standby mode
- Night mode
- Frost / heat protection

The operating mode transmitted to the bus on a button press of the controller extension is defined by the parameter "Operating mode on pressing the button". Depending on the configured functionality, it is possible that ...

- Either one of the above-mentioned modes is activated (single selection) on the press of the button,
- Or the device is switched over between two or three modes (multiple selection).

i Notes on multiple selection:

In order to ensure that a switchover from one mode into another works properly even from different locations, the operating mode objects of the controller and those of all controller extension pushbutton sensors must be interlinked and have their "Write" flag set. In the objects concerned, this flag is set by default

By checking the linked operating mode switchover object, the controller extension knows which of the possible operating modes is active. Based on this information, the device switches over into the next operating mode in sequence when a button is pressed. In the event that none of the possible operating modes is active, the next operating mode in the sequence is set to "Comfort" mode (in case of "Standby ->Night" to "Standby" mode). As far as switching over between the forced operating modes and "Auto" is concerned, the device switches into the "Auto" operating mode when none of the configured operating modes is active.

- i** It is not possible to program a reaction on release of the button. A long button-press is evaluated in the same way as short one and switches into the corresponding mode of operation in so far as this is acceptable for the controller.

- i** If a status LED is to indicate the current operating mode, the status LED function must be programmed for "Operating mode indication" and its status object be linked with the corresponding group address for operating mode switchover with normal or high priority (see chapter 4.2.4.4. Status LED).

4.2.4.7.3 Button function "Presence button"

All buttons with their function set to "Presence button" are internally linked with the "Presence button" object of the controller extension. The parameter "Presence function on pressing the button" defines the object value transmitted to the bus on pressing a button. In order to ensure that the object value transmitted in the "Presence TOGGLE" setting is always the correct one, the presence object of the room thermostat and the "Presence button" objects of the controller extension pushbutton sensors must be interlinked and have their "Write" flag set. In the extension objects concerned, this flag is set by default.

It is not possible to program a reaction on release of the button. A long button-press is evaluated in the same way as short one and switches into the corresponding mode of operation in so far as this is acceptable for the controller.

The status LED of the presence button can indicate both the presence status (setting "Button function indication active / inactive") and also the actuation of the button. In addition, the usual setting possibilities of the status LED are configurable as well.(see chapter 4.2.4.4. Status LED)

4.2.4.7.4 Button function "Setpoint shift"

The setpoint shift is another available function of the controller extension. It makes use of two 1-byte communication objects with data point type 6,010 (integer with sign). This extension function allows shifting of the basic setpoint for the temperature on a room thermostat by pressing a button. Operation of the extension is generally the same as the operation of the main controller.

A button configured as a setpoint shifting button reduces or increases the setpoint shift value on each press by one step respectively. The direction of the value adjustment is defined by the parameter "Setpoint shift on pressing the button". Releasing the button and a long press have no other functions.

Communication with main controller:

In order to enable the pushbutton sensor to effect a setpoint shift in a room thermostat, the controller must have input and output objects for setpoint shifting. In this case, the output object of the controller must be linked with the input object of the extension unit and the input object of the controller must be linked with the output object of the extension via an independent group address (see page 55).

All objects are of the same data point type and have the same value range. A setpoint shift is interpreted by count values: a shift in positive direction is expressed by positive values whereas a shift in negative direction is represented by negative object values. An object value of "0" means that no setpoint shift has been activated.

Via the "Current setpoint shift" object of the controller extensions, which is linked with the room thermostat, the extensions are enabled to determine the current setpoint shift position. Starting from the value of the communication object, each button-press on an extension will adjust the setpoint in the corresponding direction by one count value level. Each time the setpoint is adjusted, the new shift is transmitted to the room thermostat via the "Controller extension setpoint value specification" object of the controller extension. The controller itself checks the received value for the minimum and maximum temperature limits (see controller documentation) and adjusts the new setpoint shift if the values are valid. When the new count value is accepted as valid, the controller transfers this value to its output object for the setpoint shift and retransmits the value to the extension as positive feedback.

Due to the standard data point type used as the output and input object of the controller extension and the weighting of the individual level by the controller itself, each extension unit is able to determine whether a shift took place, in which direction it took place and by how many levels the setpoint was shifted. This requires that the communication objects are connected on all controller extensions and the controller.

The information for the level value as feedback from the controller enables the extension to continue the adjustment anytime at the right point. The extension units can likewise react to a reset of the setpoint shifting function by the controller.

The status LED of a setpoint shifting button can indicate both the setpoint shifting status (setting "Setpoint value shift indicator") and also the actuation of the button. In addition, the usual setting possibilities of the status LED are configurable as well (see chapter 4.2.4.4. Status LED).

For setpoint shifting status indication, the controller makes use of the step count value which is transmitted to the extension and evaluated for switching of the status LED. The "Status LED" parameter defines the switching behaviour: The LED can be permanently off and light up only after a shift has been detected (setting "ON, ..."). As an alternative, the LED can be permanently on and go out only after a shift has been detected (setting "OFF, ..."). It can also be distinguished whether the LED is ON or OFF only if...

- there has been shifting at all,
- only a positive shift has been detected,
- only a negative shift has been detected.

4.2.4.8 Alarm signal

The Comfort pushbutton sensor permits signalling of a alarm which might be, for instance, a burglar or a fire alarm of a KNX/EIB central alarm unit. An alarm is signalled by all status LEDs and of the operation LED of the pushbutton sensor flashing synchronously. The alarm can be separately enabled with the parameter "Alarm signal display" on parameter page "Alarm signalling" so that it can be used.

When alarm signalling is enabled, the ETS displays the communication object "Alarm signalling" and further alarm function parameters.

The alarm signalling object is used as an input for activating or deactivating alarm signal displaying. The polarity of the object can be selected. When the object value corresponds to the "Alarm" condition, all status LEDs and the operation LED are always flashing with a frequency of approx. 2 Hz. If there is an alarm, the behaviour of the operating LED as configured in the ETS and the status LED for normal operation have no significance. The LEDs adopt their originally configured behaviour only after the alarm signalling function has been deactivated. Changes of the state of the LEDs during an alarm - if they are controlled by separate LED objects or if they signal button functions - are internally stored and recovered at the end of the alarm.

Apart from the possibility of deactivating an alarm signal via the alarm object, it can also be deactivated locally by a button-press on the pushbutton sensor itself. The "Reset alarm signalling by a button-press?" parameter defines the button response during an alarm...

- If this parameter is set to "Yes", active alarm signal displaying can be deactivated by a button-press on the pushbutton sensor. This button-press does not cause the configured function of the pressed button to be executed. Only after then next button-press will the configuration of the button be evaluated and a telegram be transmitted to the bus, if applicable.
- If "No" has been selected, alarm signalling can only be deactivated via the alarm signalling object. A button-press will always directly execute the configured button function.

If alarm signalling can be deactivated by a button-press, the parameter "Acknowledge alarm signalling by" defines whether an additional alarm acknowledge telegram is to be transmitted to the bus via the separate object "Alarm signalling acknowledge" after triggering by this button-press.

Such an acknowledge telegram can, for instance, be sent via a 'listening' group address to the "Alarm signalling" objects of other pushbutton sensors in order to reset the alarm status there as well. Attention must be paid during resetting of an alarm to the selectable polarity of the acknowledge object.

- i** Notes on the alarm signalling function: If the setting is "Alarm when OFF and alarm reset when ON", the alarm object must be actively written by the bus with "0" to activate the alarm after a reset or after programming with the ETS.
- i** An active alarm signal is not stored so that the alarm signalling is generally deactivated after a device reset or after programming with the ETS.

4.2.5 Delivery state

Delivery state and non runnable application

As long as pushbutton sensor has not yet been programmed with application data by means of the ETS, the operation LED flashes at a slow rate (approx. 0.75 Hz). When any of the buttons or rockers is pressed, the appropriate status LED lights up briefly (button-press display). This condition persists until the application is programmed into the device.

By slow flashing of its operation LED (approx. 0.75 Hz), the pushbutton sensor can also indicate that a wrong application has been programmed into its memory. Applications are non run-capable if they are not intended for use with the pushbutton sensor in the ETS product database. Attention must also be paid to the fact that the pushbutton sensor variant is compatible with the one in the project (e.g. 4x version created in the ETS project and also installed).

The operation LED flashes slowly also if the application program of the touch sensor has been removed from the device by the ETS.
In both cases, the pushbutton sensor is not operational.

4.2.6 Parameters

Description	Values	Comment
□↳ General		
Transmit delay after reset or bus voltage return	Yes	<p>After a reset (e.g. after loading of an application program or the physical address or after return of bus voltage), the pushbutton sensor can automatically transmit telegrams for the room thermostat extension functions. In case of the controller extension, the pushbutton sensor attempts to retrieve values from the room thermostat by means of read telegrams in order to update the object states. In case of the room temperature measurement, the pushbutton sensor transmits the current room temperature after a reset to the bus.</p> <p>If there are still other bus devices besides the pushbutton sensor transmitting telegrams immediately after a reset, it may be useful to activate the transmit delay for automatically transmitting objects in order to reduce the bus load.</p> <p>When transmit delay is activated (setting: "Yes"), the pushbutton sensor computes the delay from its device ID in the physical address. The sensor then waits 30 seconds maximum before transmitting telegrams.</p>
	No	
Light period of status LED for button-press display	1 s	<p>This parameter defines the time the status LED is lit up to indicate actuation. The setting concerns all status LEDs whose function is set to "Button-press display".</p>
	2 s	
	3 s	
	4 s	
	5 s	
Function of operation LED	Always OFF	<p>This parameter defines the function of the operation LED.</p> <p>The operation LED is always off.</p>
	Always ON	<p>The operation LED is always on, for instance, as orientation lighting.</p>
	Control via object	<p>The operation LED is controlled by a separate communication object.</p>
	Flashing	<p>The operation LED flashes permanently with a frequency of about 0.75 Hz.</p> <p>Besides the function set here, the operation LED can display different states by means of other flashing rates.</p>

		These comprise Programming mode, the confirmation of full-surface actuation or the message that an application has not been loaded.
Control of the operation LED via the object value	1 = LED static ON / 0 = LED static OFF 1 = LED static OFF / 0 = LED static ON 1 = LED flashes / 0 = LED static OFF 1 = LED static OFF / 0 = LED flashes	If the "Function of the operation LED" is set to "Control via object", then the telegram polarity of the 1-bit object "Operation LED" can be specified at this point. The LED can be switched on or off statically. In addition, the received switching telegram can be evaluated in such a way that the LED flashes.
Controller extension	Enabled Disabled	This parameter enables the communication objects and the parameter page for the room thermostat extension. In addition, at least one rocker must be divided into two buttons to permit full use of the controller extension features.
Value request from controller extension?	Yes No	In order to enable the pushbutton sensor to transmit the correct values after a press on the buttons representing the controller extension, the "Operating mode selection", "Forced operating mode switchover", "Active setpoint shift" and "Presence button" communication objects can transmit read requests after a reset. This parameter is only visible, if the parameter "Controller extension" is set to "enabled".
<p>☐↔ Operation concept</p>		
Operation concept of buttons 1 and 2	Rocker function (rocker 1) Button function	For each operating area, the user can independently specify whether it is to be used as a rocker with a common basic function or as two different buttons with completely independent functions. Depending on this setting, the ETS displays different communication objects and parameter pages.
(The same parameters are available for the other operating areas / button pairs.)		
Button evaluation		If the operation concept of an operating area is configured as "pushbutton function", this parameter can be used to specify whether single-surface or
(The same parameters are available for the		

other operating areas /
button pairs.)

double-surface operation should be
implemented.

Single area operation (only
as button 1)

In single-surface operation, the entire
operating area is evaluated only as a
single "large" button. The surface can be
depressed at any desired point in order
to execute the underlying pushbutton
function. In this setting, the button with
the even button number of the button
pair (e.g. button 2) is inactive and
physically not present.

**Double-area operation (as
buttons 1 + 2)**

In double-surface operation, the
operating area is divided into two
mutually independent buttons.

☐ Rocker 1 (buttons 1/2) (only if "Function of buttons 1 and 2 = as one rocker (rocker 1)!")

Function

Switching

Dimming
Venetian blind
1-byte value transmitter
2-byte value transmitter
Scene extension
2-channel operation

This parameter is used to define the
basic function of the rocker.
Depending on this choice, the ETS
displays different communication objects
and parameters for this rocker.

The following parameters are only valid for the rocker function "Switching"...

Command on pressing
left rocker

No reaction
ON
OFF
TOGGLE

These parameters specify the reaction
when the left rocker is pressed or
released.

Command on releasing
left rocker

No reaction
ON
OFF
TOGGLE

Command on pressing
right rocker

No reaction
ON
OFF
TOGGLE

These parameters specify the reaction
when the right rocker is pressed or
released.

Command on releasing
right rocker

No reaction
ON
OFF
TOGGLE

The following parameters are only valid for the rocker function "Dimming"...

Command on pressing
left rocker

No reaction
Brighter (ON)
Darker (OFF)
Brighter / darker (TOGGLE)
Brighter (TOGGLE)
Darker (TOGGLE)

This parameter defines the reaction
when the left rocker is pressed.
If the pushbutton sensor is to toggle on
a brief press, the corresponding
switching objects of other sensors with
the same function must be linked with
one another. In the "Brighter/darker
(TOGGLE)" setting, the dimming objects

		must be interlinked as well so that the pushbutton sensor can send the correct telegram on the next button-press.
Command on pressing right rocker	No reaction Brighter (ON) Darker (OFF) Brighter / darker (TOGGLE) Brighter (TOGGLE) Darker (TOGGLE)	This parameter defines the reaction when the right rocker is pressed. If the pushbutton sensor is to toggle on a brief press, the corresponding switching objects of other sensors with the same function must be linked with one another. In the "Brighter/darker (TOGGLE)" setting, the dimming objects must be interlinked as well so that the pushbutton sensor can send the correct telegram on the next button-press.
Time between switching and dimming, left rocker (100 ... 50000 x 1 ms)	100 ... 400 ... 50000	This parameter defines how long the left rocker must be pressed for the pushbutton sensor to send a dimming telegram.
Time between switching and dimming, right rocker (100 ... 50000 x 1 ms)	100 ... 400 ... 50000	This parameter defines how long the right rocker must be pressed for the pushbutton sensor to send a dimming telegram.
Advanced parameters	Activated Deactivated	When the advanced parameters are activated, the ETS shows the following parameters.
Advanced parameters activated...		
Increase brightness by	1.5 % 3 % 6 % 12.5 % 25 % 50 % 100 %	This parameter sets the relative dimming level when the brightness is increased. On each button-press, the brightness is changed at maximum by the configured level. Especially with smaller dimming levels it is advisable for the pushbutton sensor to repeat the dimming telegrams automatically (see "telegram repetition").
Reduce brightness by	1.5 % 3 % 6 % 12.5 % 25 %	This parameter sets the relative dimming level when the brightness is reduced. On each button-press, the brightness is changed at maximum by the configured level. Especially with smaller dimming levels it

	50 % 100 %	is advisable for the pushbutton sensor to repeat the dimming telegrams automatically (see "telegram repetition").
Transmit stop telegram?	Yes No	On "Yes" the pushbutton sensor transmits a telegram for stopping the dimming process when the rocker is released. When the pushbutton sensor transmits telegrams for dimming in smaller levels, the stop telegram is generally not needed.
Telegram repeat?	Yes No	This parameter can be used to activate telegram repetition for dimming. With the button held down, the pushbutton sensor will then transmit the relative dimming telegrams (in the programmed level width) until the button is released.
Time between two telegrams	200 ms 300 ms 400 ms 500 ms 750 ms 1 s 2 s	This parameter defines the interval at which the dimming telegrams are automatically repeated in the telegram repetition mode. This parameter is visible only if "Telegram repetition = Yes"!
Full-surface operation	Enabled Disabled	When the full-surface operation is enabled, the ETS shows the following parameters.
Function for full-surface operation	Switching Scene recall without storage function Scene recall with storage function	In case of full-surface operation, this parameter defines the function that is to be used. The ETS shows the corresponding communication object and the other parameters. If the pushbutton sensor is to recall a scene with storage function by full-surface actuation, it will make a distinction between a brief press (less than 1 s), a sustained press (longer than 5 s) and an invalid button-press (between 1 s and 5 s). A brief press recalls the scene, a sustained press stores a scene and an invalid full-surface operation is ignored. This parameter is visible only if "Full-surface actuation = enabled"!
Command for full-surface operation	ON OFF TOGGLE	This parameter defines the value of the transmitted telegram when a full-surface operation has been sensed. "TOGGLE"

		switches over the current object value. This parameter is visible only if "Full-surface actuation = enabled"!
Scene number (1 ... 64)	1, 2, ..., 64	This parameter defines the scene number which is to be transmitted to the bus after a scene recall or during storage of a scene. This parameter is visible only if "Full-surface actuation = enabled"!
The following parameters are only valid for the rocker function "Venetian blind"...		
Command on pressing rocker	Left rocker: UP / Right rocker: DOWN Left rocker: DOWN / Right rocker: UP Left rocker: TOGGLE / Right rocker: TOGGLE	This parameter defines the running direction of a drive after a button-press. If the setting is "TOGGLE", the direction is changed after each long time command. If several pushbuttons are to control the same drive, the long time objects of the pushbuttons must be interlinked for a correct change of the running direction.
Operation concept	short – long – short long – short short – long long – short or short	For Venetian blind control, four different operation concepts can be selected. For these concepts, the ETS shows further parameters.
Time between short time and long time command, left rocker (1 ... 3000 x 100 ms)	1 ... 4 ... 3000	This parameter sets the time after which the long time operation will be evaluated on pressing the top (or left-hand) button of the rocker. This parameter is not visible with "Operation concept = long – short"!
Time between short time and long time command, right rocker (1 ... 3000 x 100 ms)	1 ... 4 ... 3000	This parameter sets the time after which the long time operation will be evaluated on pressing the bottom (or right-hand) button of the rocker. This parameter is not visible with "Operation concept = long – short"!
Slat adjusting time, left rocker (0 ... 3000 x 100 ms)	0 ... 5 ... 3000	Time during which a transmitted long time telegram can be terminated by releasing the left button of the rocker (short time). This function serves to adjust the slats of a blind. This parameter is not visible with "Operation concept = long – short"!

Slat adjusting time, right rocker (0 ... 3000 x 100 ms)	0 ... 5 ... 3000	Time during which a transmitted long time telegram can be terminated by releasing the right button of the rocker (short time). This function serves to adjust the slats of a blind. This parameter is not visible with "Operation concept = long – short"!
Full-surface operation	Enabled Disabled	When the full-surface operation is enabled, the ETS shows the following parameters. Full-surface operation can only be programmed if "Operation concept = long – short or short"!
Function for full-surface operation	Switching Scene recall without storage function Scene recall with storage function	In case of full-surface operation, this parameter defines the function that is to be used. The ETS shows the corresponding communication object and the other parameters. If the pushbutton sensor is to recall a scene with storage function by full-surface actuation, it will make a distinction between a brief press (less than 1 s), a sustained press (longer than 5 s) and an invalid button-press (between 1 s and 5 s). A brief press recalls the scene, a sustained press stores a scene and an invalid full-surface operation is ignored. This parameter is visible only if "Full-surface actuation = enabled"!
Command for full-surface operation	ON OFF TOGGLE	This parameter defines the value of the transmitted telegram when a full-surface operation has been sensed. "TOGGLE" switches over the current object value. This parameter is visible only if "Full-surface actuation = enabled"!
Scene number (1 ... 64)	1, 2, ..., 64	This parameter defines the scene number which is to be transmitted to the bus after a scene recall or during storage of a scene. This parameter is visible only if "Full-surface actuation = enabled"!

The following parameters are only valid for the rocker function "Value transmitter 1-byte"...

Function

	Left rocker / right, no function		A rocker configured as "Value transmitter 1 byte" permits selecting whether the values to be transmitted are interpreted as integers from 0 to 255 or as a percentage from 0 % to 100 %. The following parameters and their settings depend on this distinction.
	Left rocker: 0 ... 255 / Right rocker: 0 ... 255		
	Left rocker: 0 ... 100 % / Right rocker: 0 ... 100 %		
	Left rocker: 0 ... 255 / Right rocker: No function		
	Left rocker: 0 ... 100 % / Right rocker: No function		
	Left rocker: No function / right rocker: 0 ... 255		
	Left rocker: No function / right rocker: 0 ... 100 %		
Value, left rocker (0 ... 255)	0...255		This parameter defines the object value when the left rocker is pressed. Visible only if "Function = ... 0...255"!
Value, right rocker (0 ... 255)	0...255		This parameter defines the object value when the right rocker is pressed. Visible only if "Function = ... 0...255"!
Value, left rocker (0 ... 100 %)	0...100		This parameter defines the object value when the left rocker is pressed. Visible only if "Function = ... 0...100 %"!
Value, right rocker (0 ... 100 %)	0...100		This parameter defines the object value when the right rocker is pressed. Visible only if "Function = ... 0...100 %"!
Value adjustment by long button-press	Enabled Disabled		If value adjustment by long button-press is enabled, the ETS shows further parameters. Value adjustment begins, when the button is held down for more than 5 s. In this case, the respective status LED flashes as a sign that a new telegram has been transmitted.
Starting value in case of value adjustment		Same as configured value	Value adjustment can begin with different starting values.

		After each long press, the pushbutton sensor always starts with the value configured in the ETS.
	Same as value after last adjustment	After a long press, the pushbutton sensor starts with the value transmitted by itself or by another device with this group address as the last value.
	Same as value from communication object	After a long press, the pushbutton sensor starts with the value transmitted by itself or by another device with this group address as the last value. This parameter is only visible if "Value adjustment by long key-press = enabled"!
Direction of value adjustment	Upwards	With a long press, the pushbutton sensor can either vary the values always in the same direction or it stores the direction of the last adjustment and reverses it on the next button-press. This parameter is only visible if "Value adjustment by long key-press = enabled"!
	Downwards	
	Toggling (alternating)	
Level size (1 ... 15)	1...15	In a value adjustment, the pushbutton sensor determines the new telegram value from the previous value and the preset level size. If the value falls below the lower limit of the adjustment range (0 or 0 %) or if it exceeds the upper limit (255 or 100%), the sensor adapts the level size of the last level automatically. This parameter is only visible if "Value adjustment by long key-press = enabled"!
Time between two telegrams	0.5 s	In a value adjustment, the pushbutton sensor determines the new telegram value from the previous value and the preset level size. If the value falls below the lower limit of the adjustment range (0 or 0 %) or if it exceeds the upper limit (255 or 100%), the sensor adapts the level size of the last level automatically. This parameter is only visible if "Value adjustment by long key-press = enabled"!
	1 s	
	2 s	
	3 s	
Value adjustment with overflow	Yes	If value adjustment is to be effected without overflow (setting "No") and if the pushbutton sensor reaches the lower limit of the adjustment range (0 or 0 %) or the upper limit (255 or 100 %) during
	No	

value adjustment, the adjustment will be stopped automatically by the sensor. If the value adjustment with overflow is programmed (setting "Yes") and if the pushbutton sensor reaches the lower or the upper limit, it will transmit the value of this range limit and then add a pause the duration of which corresponds to two levels. Thereafter, the pushbutton sensor transmits a telegram with the value of the other range limits and continues the value adjustment in the same direction.

The following parameters are only valid for the rocker function "Value transmitter 2-byte"...

Function	Temperature value transmitter	
	Brightness value transmitter	
	Value transmitter (0 ... 65535)	A rocker configured as "Value transmitter 1 byte" permits selecting whether the values to be transmitted are to be interpreted as temperature values (0 °C to 40 °C), as brightness values (0 lux to 1500 lux) or as integers (0 to 65535). The following parameters and their settings depend on this selection.
Temperature value (0 ... 40 °C) Left rocker	0... 20 ...40	This parameter defines the object value when the left rocker is pressed. This is only visible if "Function = Temperature value transmitter"!
Temperature value (0 ... 40 °C) Right rocker	0... 20 ...40	This parameter defines the object value when the right rocker is pressed. This is only visible if "Function = Temperature value transmitter"!
Brightness value Left rocker	0, 50, ... 300 ... 1450, 1500 lux	This parameter defines the object value when the left rocker is pressed. This is only visible if "Function = Brightness value transmitter"!
Brightness value Right rocker	0, 50, ... 300 ... 1450, 1500 lux	This parameter defines the object value when the right rocker is pressed. This is only visible if "Function = Brightness value transmitter"!
Value (0 ... 65535) Left rocker	0 ... 65535	This parameter defines the object value when the left rocker is pressed. This is only visible if "Function = Value transmitter (0 ... 65535)"!

Value (0 ... 65535) Right rocker	0 ... 65535	This parameter defines the object value when the right rocker is pressed. This is only visible if "Function = Value transmitter (0 ... 65535)"!
Value adjustment by long button-press	Enabled Disabled	If value adjustment by long button-press is enabled, the ETS shows further parameters. Value adjustment begins, when the button is held down for more than 5 s. In this case, the respective status LED flashes as a sign that a new telegram has been transmitted.
Starting value in case of value adjustment	Same as configured value Same as value after last adjustment Same as value from communication object	Value adjustment can begin with different starting values. After each long press, the pushbutton sensor always starts with the value configured in the ETS. After a long press, the pushbutton sensor starts with the value transmitted by itself or by another device with this group address as the last value. After a long press, the pushbutton sensor starts with the value transmitted by itself or by another device with this group address as the last value. This setting selectable only if "Functionality = Value transmitter (0...65535)! This parameter is only visible if "Value adjustment by long key-press = enabled"!
Direction of value adjustment	Upwards Downwards Toggling (alternating)	With a long press, the pushbutton sensor can either vary the values always in the same direction or it stores the direction of the last adjustment and reverses it on the next button-press. This parameter is only visible if "Value adjustment by long key-press = enabled"!
Level size	1 °C	For temperature values the level size of the adjustment is permanently set to 1 °C. This parameter is only visible if "Function = Temperature value transmitter" and "Value adjustment by long button-press = enabled"!

Level size	50 lux	For brightness values, the level size of the adjustment is fixed to 50 lux. This parameter is only visible if "Function = Brightness value transmitter" and "Value adjustment by long button-press = enabled"!
Level size	1 2 5 10 20 50 75 100 200 500 750 1000	This parameter sets the level size of the value adjustment for the 2-byte value transmitter. This parameter is only visible if "Function = Value transmitter (0 ... 65535)" and "Value adjustment by long button-press = enabled"!
Time between two telegrams	0.5 s 1 s 2 s 3 s	This parameter defines the interval at which the pushbutton sensor transmits new telegrams during a value adjustment. This parameter is only visible if "Value adjustment by long key-press = enabled"!
Value adjustment with overflow	Yes No	If value adjustment is to be effected without overflow (setting "No") and if the pushbutton sensor reaches the lower limit of the adjustment range (0°C, 0 lux, 0) or the upper limit (40°C, 1500 lux, 65535) during value adjustment, the adjustment will be stopped automatically by the sensor. If the value adjustment with overflow is programmed (setting "Yes") and if the pushbutton sensor reaches the lower or the upper limit, it will transmit the value of this range limit and then add a pause the duration of which corresponds to two levels. Thereafter, the pushbutton sensor transmits a telegram with the value of the other range limits and continues the value adjustment in the same direction.

The following parameters are only valid for the rocker function "Scene extension"...

Function	Scene extension without storage function	This parameter defines the functionality of the extension.
----------	---	--

	Scene extension with storage function	If the pushbutton sensor is used as a scene extension, the scenes can either be stored in one or in several other KNX/EIB devices
	Recall of internal scene extension without storage function	(e.g. light scene pushbutton sensor). During a scene recall or in a storage function, the pushbutton sensor transmits a telegram with the respective scene number via the extension object of the rocker.
	Recall of internal scene with storage function	During the recall of an internal scene, a scene stored internally in the pushbutton sensor is recalled or stored again. In this case, the sensor transmits no telegram to the bus via a scene extension object. For this setting, the internal scene function must be enabled.
Scene number (1 ... 64) Left rocker	1...64	In accordance with the KNX standard, objects with data type 18.001 "Scene Control" can recall or store up to 64 scenes by their numbers. The parameter defines the scene number to be transmitted when a left button is pressed.
Scene number (1 ... 64) Right rocker	1...64	In accordance with the KNX standard, objects with data type 18.001 "Scene Control" can recall or store up to 64 scenes by their numbers. The parameter defines the scene number to be transmitted when a right button is pressed.
Scene number (1 ... 8) Left rocker	1...8	This parameter defines the number of the internal scene which is recalled or stored when a left button is pressed.
Scene number (1 ... 8) Right rocker	1...8	This parameter defines the number of the internal scene which is recalled or stored when a right button is pressed.
The following parameters are only valid for the rocker function "2-channel operation"...		
Operation concept	Channel 1 or channel 2 Channel 1 and channel 2	This parameter defines the 2-channel operation concept. If the setting "Channel 1 or channel 2" is selected, the pushbutton sensor decides dependent on the button-press duration which of the channels will be used. If the setting "Channel 1 and channel 2" is selected, the pushbutton sensor transmits only the telegram of channel 1

		on a short button-press and both telegrams on a sustained button-press.
Function channel 1 (2)	No function Switching (1 bit) Value transmitter 0 ... 255 (1-byte) Value transmitter 0 ... 100 % (1-byte) Temperature value transmitter (2 bytes)	This parameter defines the channel function and specifies which other parameters and which communication object are to be displayed for channel 1 (2).
Command of the button for channel 1 (2) Left rocker	ON OFF TOGGLE	This parameter defines the object value transmitted to the bus, when the left-hand rocker is pressed. This is only visible if "Function channel 1 (2) = Switching (1 bit)"!
Command of the button for channel 1 (2) Right rocker	ON OFF TOGGLE	This parameter defines the object value transmitted to the bus, when the right-hand rocker is pressed. This is only visible if "Function channel 1 (2) = Switching (1 bit)"!
Value of the button for Channel 1 (2) Left rocker (0...255)	0...255	This parameter defines the object value transmitted to the bus, when the left-hand rocker is pressed. It is only visible if "Function channel 1 (2) = Value transmitter 0...255 (1 byte)"!
Value of the button for Channel 1 (2) Right rocker (0...255)	0...255	This parameter defines the object value transmitted to the bus, when the right-hand rocker is pressed. It is only visible if "Function channel 1 (2) = Value transmitter 0...255 (1 byte)"!
Value of the button for Channel 1 (2) Left rocker (0 ... 100 %)	0...100	This parameter defines the object value transmitted to the bus, when the left-hand rocker is pressed. It is only visible if "Function channel 1 (2) = Value transmitter 0...100 % (1-byte)"!
Value of the button for Channel 1 (2) Right rocker (0 ... 100 %)	0...100	This parameter defines the object value transmitted to the bus, when the right-hand rocker is pressed. It is only visible if "Function channel 1 (2) = Value transmitter 0...100 % (1-byte)"!

Temperature value of the button for channel 1 (2) Left rocker (0 ... 40 °C)	0...40	This parameter defines the temperature value transmitted to the bus when the left-hand rocker is pressed. It is only visible if "Function channel 1 (2) = Temperature value transmitter (2 bytes)"!
Temperature value of the button for channel 1 (2) Right rocker (0 ... 40 °C)	0...40	This parameter defines the temperature value transmitted to the bus when the right-hand rocker is pressed. It is only visible if "Function channel 1 (2) = Temperature value transmitter (2 bytes)"!
Time between channel 1 and channel 2 Left rocker (1 ... 255 x 100 ms)	0...30...255	Depending on the selected operation concept, this parameter defines the interval at which the sensor transmits the telegram for channel 1 and the telegram for channel 2 when the left side of the rocker is pressed.
Time between channel 1 and channel 2 Right rocker (1 ... 255 x 100 ms)	0...30...255	Depending on the selected operation concept, this parameter defines the interval at which the sensor transmits the telegram for channel 1 and the telegram for channel 2 when the right side of the rocker is pressed.
Full-surface operation	Enabled Disabled	When the full-surface operation is enabled, the ETS shows the following parameters. Full-surface operation can only be programmed if "Operation concept = Channel 1 or channel 2"!
Function for full-surface operation	Switching Scene recall without storage function Scene recall with storage function	In case of full-surface operation, this parameter defines the function that is to be used. The ETS shows the corresponding communication object and the other parameters. If the pushbutton sensor is to recall a scene with storage function by full-surface actuation, it will make a distinction between a brief press (less than 1 s), a sustained press (longer than 5 s) and an invalid button-press (between 1 s and 5 s). A brief press recalls the scene, a sustained press stores a scene and an invalid full-surface operation is ignored. This parameter is visible only if "Full-surface actuation = enabled"!

Command for full-surface operation	ON OFF TOGGLE	This parameter defines the value of the transmitted telegram when a full-surface operation has been sensed. "TOGGLE" switches over the current object value. This parameter is visible only if "Full-surface actuation = enabled"!
------------------------------------	----------------------------	--

Scene number (1 ... 64)	1, 2, ..., 64	This parameter defines the scene number which is to be transmitted to the bus after a scene recall or during storage of a scene. This parameter is visible only if "Full-surface actuation = enabled"!
-------------------------	---------------	--

Rocker 2 (Buttons 3/4) ... Rocker n, see Rocker 1!

Button 1 (only if "Function of buttons 1 and 2 = as separate buttons"!)

Function	No function Switching Dimming Venetian blind 1-byte value transmitter 2-byte value transmitter Scene extension 2-channel operation Controller extension *	This parameter defines the basic function of the button. Depending on this setting, the ETS displays different communication objects and parameters for this button.
	*: Must have been enabled under "General"!	

The following parameters are only valid for the pushbutton function "Switching"...

Command on pressing the button	No reaction ON OFF TOGGLE	These parameters specify the reaction when the button is pressed or released.
Command on releasing the button	No reaction ON OFF TOGGLE	

The following parameters are only valid for the pushbutton function "Dimming"...

Command on pressing the button	No reaction Brighter (ON) Darker (OFF) Brighter / darker (TOGGLE) Brighter (TOGGLE) Darker (TOGGLE)	This parameter defines the reaction when the button is pressed. If the pushbutton sensor is to toggle on a brief press, the corresponding switching objects of other sensors with the same function must be linked with one another. In the "Brighter/darker (TOGGLE)" setting, the dimming objects must be interlinked as well so that the pushbutton sensor can send the correct telegram on the next button-press.
--------------------------------	---	---

Time between switching and dimming (100 ... 50000 x 1 ms)	100 ... 400 ... 50000	This parameter defines how long the button must be pressed for the pushbutton sensor to transmit a dimming telegram.
Advanced parameters	Activated Deactivated	When the advanced parameters are activated, the ETS shows the following parameters.
Advanced parameters activated...		
Increase brightness by	1.5 % 3 % 6 % 12.5 % 25 % 50 % 100 %	This parameter sets the relative dimming level when the brightness is increased. On each button-press, the brightness is changed at maximum by the configured level. Especially with smaller dimming levels it is advisable for the pushbutton sensor to repeat the dimming telegrams automatically (see "telegram repetition").
Reduce brightness by	1.5 % 3 % 6 % 12.5 % 25 % 50 % 100 %	This parameter sets the relative dimming level when the brightness is reduced. On each button-press, the brightness is changed at maximum by the configured level. Especially with smaller dimming levels it is advisable for the pushbutton sensor to repeat the dimming telegrams automatically (see "telegram repetition").
Transmit stop telegram?	Yes No	On "Yes" the pushbutton sensor transmits a telegram for stopping the dimming process when the rocker is released. When the pushbutton sensor transmits telegrams for dimming in smaller levels, the stop telegram is generally not needed.
Telegram repeat?	Yes No	This parameter can be used to activate telegram repetition for dimming. With the button held down, the pushbutton sensor will then transmit the relative dimming telegrams (in the programmed level width) until the button is released.
Time between two telegrams	200 ms 300 ms	This parameter defines the interval at which the dimming telegrams are

400 ms	automatically repeated in the telegram repetition mode.
500 ms	This parameter is visible only if
750 ms	"Telegram repetition = Yes"!
1 s	
2 s	

The following parameters are only valid for the pushbutton function "Venetian blind"...

Command on pressing the button	DOWN UP TOGGLE	This parameter defines the running direction of a drive after a button-press. If the setting is "TOGGLE", the direction is changed after each long time command. If several pushbuttons are to control the same drive, the long time objects of the pushbuttons must be interlinked for a correct change of the running direction.
Operation concept	short – long – short long – short short – long long – short or short	For Venetian blind control, four different operation concepts can be selected. For these concepts, the ETS shows further parameters.
Time between short-time and long-time command (1 ... 3000 x 100 ms)	1 ... 4 ... 3000	This parameter sets the time after which the long time operation will be evaluated on pressing the top (or left-hand) button of the rocker. This parameter is not visible with "Operation concept = long – short"!
Slat moving time (0 ... 3000 x 100 ms)	0 ... 5 ... 3000	Time during which a transmitted long time telegram can be terminated by releasing the top (or left-hand) button of the rocker (short time). This function serves to adjust the slats of a blind. This parameter is not visible with "Operation concept = long – short"!

The following parameters are only valid for the push button function "Value transmitter 1 byte"...

Function	Value transmitter 0 ... 255 Value transmitter 0 ... 100 %	A button configured as "Value transmitter 1 byte" permits selecting whether the values to be transmitted are interpreted as integers from 0 to 255 or as a percentage from 0 % to 100 %. The following parameters and their settings depend on this distinction.
Value (0 ... 255)	0...255	This parameter defines the object value when the button is pressed. Visible only if "Function = ... 0...255"!

Value (0 ... 100 %)	0...100	This parameter defines the object value when the button is pressed. Visible only if "Function = ... 0...100 %"!
Value adjustment by long button-press	Enabled Disabled	If value adjustment by long button-press is enabled, the ETS shows further parameters. Value adjustment begins, when the button is held down for more than 5 s. In this case, the respective status LED flashes as a sign that a new telegram has been transmitted.
Starting value in case of value adjustment	Same as configured value	Value adjustment can begin with different starting values. After each long press, the pushbutton sensor always starts with the value configured in the ETS.
	Same as value after last adjustment	After a long press, the pushbutton sensor starts with the value transmitted by itself or by another device with this group address as the last value.
	Same as value from communication object	After a long press, the pushbutton sensor starts with the value transmitted by itself or by another device with this group address as the last value. This parameter is only visible if "Value adjustment by long key-press = enabled"!
Direction of value adjustment	Upwards	With a long press, the pushbutton sensor can either vary the values always in the same direction or it stores the direction of the last adjustment and reverses it on the next button-press. This parameter is only visible if "Value adjustment by long key-press = enabled"!
	Downwards	
	Toggling (alternating)	
Level size (1 ... 15)	1...15	In a value adjustment, the pushbutton sensor determines the new telegram value from the previous value and the preset level size. If the value falls below the lower limit of the adjustment range (0 or 0 %) or if it exceeds the upper limit (255 or 100%), the sensor adapts the level size of the last level automatically. This parameter is only visible if "Value adjustment by long key-press = enabled"!

Time between two telegrams	0.5 s 1 s 2 s 3 s	In a value adjustment, the pushbutton sensor determines the new telegram value from the previous value and the preset level size. If the value falls below the lower limit of the adjustment range (0 or 0 %) or if it exceeds the upper limit (255 or 100%), the sensor adapts the level size of the last level automatically. This parameter is only visible if "Value adjustment by long key-press = enabled"!
Value adjustment with overflow	Yes No	If value adjustment is to be effected without overflow (setting "No") and if the pushbutton sensor reaches the lower limit of the adjustment range (0 or 0 %) or the upper limit (255 or 100 %) during value adjustment, the adjustment will be stopped automatically by the sensor. If the value adjustment with overflow is programmed (setting "Yes") and if the pushbutton sensor reaches the lower or the upper limit, it will transmit the value of this range limit and then add a pause the duration of which corresponds to two levels. Thereafter, the pushbutton sensor transmits a telegram with the value of the other range limits and continues the value adjustment in the same direction.

The following parameters are only valid for the push button function "Value transmitter 2 byte"...

Function	Temperature value transmitter Brightness value transmitter Value transmitter (0 ... 65535)	A button configured as "Value transmitter 1 byte" permits selecting whether the values to be transmitted are to be interpreted as temperature values (0 °C to 40 °C), as brightness values (0 lux to 1500 lux) or as integers (0 to 65535). The following parameters and their settings depend on this selection.
Temperature value (0 ... 40 °C)	0... 20 ...40	This parameter defines the object value when the button is pressed. This is only visible if "Function = Temperature value transmitter"!
Brightness value	0, 50, ... 300 ... 1450, 1500 lux	This parameter defines the object value when the button is pressed. This is only visible if "Function = Brightness value transmitter"!

Value (0 ... 65535)	0 ... 65535	This parameter defines the object value when the button is pressed. This is only visible if "Function = Value transmitter (0 ... 65535)"!
Value adjustment by long button-press	Enabled Disabled	If value adjustment by long button-press is enabled, the ETS shows further parameters. Value adjustment begins, when the button is held down for more than 5 s. In this case, the respective status LED flashes as a sign that a new telegram has been transmitted.
Starting value in case of value adjustment	Same as configured value Same as value after last adjustment Same as value from communication object	Value adjustment can begin with different starting values. After each long press, the pushbutton sensor always starts with the value configured in the ETS. After a long press, the pushbutton sensor starts with the value transmitted by itself or by another device with this group address as the last value. After a long press, the pushbutton sensor starts with the value transmitted by itself or by another device with this group address as the last value. This setting selectable only if "Function = Value transmitter (0...65535)"! This parameter is only visible if "Value adjustment by long key-press = enabled"!
Direction of value adjustment	Upwards Downwards Toggling (alternating)	With a long press, the pushbutton sensor can either vary the values always in the same direction or it stores the direction of the last adjustment and reverses it on the next button-press. This parameter is only visible if "Value adjustment by long key-press = enabled"!
Level size	1 °C	For temperature values the level size of the adjustment is permanently set to 1 °C. This parameter is only visible if "Function = Temperature value transmitter" and "Value adjustment by long button-press = enabled"!

Level size	50 lux	For brightness values, the level size of the adjustment is fixed to 50 lux. This parameter is only visible if "Function = Brightness value transmitter" and "Value adjustment by long button-press = enabled"!
Level size	1 2 5 10 20 50 75 100 200 500 750 1000	This parameter sets the level size of the value adjustment for the 2-byte value transmitter. This parameter is only visible if "Function = Temperature value transmitter" and "Value adjustment by long button-press = enabled"!
Time between two telegrams	0.5 s 1 s 2 s 3 s	This parameter defines the interval at which the pushbutton sensor transmits new telegrams during a value adjustment. This parameter is only visible if "Value adjustment by long key-press = enabled"!
Value adjustment with overflow	Yes No	If value adjustment is to be effected without overflow (setting "No") and if the pushbutton sensor reaches the lower limit of the adjustment range (0°C, 0 lux, 0) or the upper limit (40°C, 1500 lux, 65535) during value adjustment, the adjustment will be stopped automatically by the sensor. If the value adjustment with overflow is programmed (setting "Yes") and if the pushbutton sensor reaches the lower or the upper limit, it will transmit the value of this range limit and then add a pause the duration of which corresponds to two levels. Thereafter, the pushbutton sensor transmits a telegram with the value of the other range limits and continues the value adjustment in the same direction.

The following parameters are only valid for the pushbutton function "scene extension"...

Function	Scene extension without storage function	This parameter defines the functionality of the extension.
----------	---	--

	Scene extension with storage function	If the pushbutton sensor is used as a scene extension, the scenes can either be stored in one or in several other KNX/EIB devices
	Recall of internal scene extension without storage function	(e.g. light scene pushbutton sensor). During a scene recall or in a storage function, the pushbutton sensor transmits a telegram with the respective scene number via the extension object of the rocker.
	Recall of internal scene with storage function	During the recall of an internal scene, a scene stored internally in the pushbutton sensor is recalled or stored again. In this case, the sensor transmits no telegram to the bus via a scene extension object. For this setting, the internal scene function must be enabled.
Scene number (1 ... 64)	1...64	In accordance with the KNX standard, objects with data type 18.001 "Scene Control" can recall or store up to 64 scenes by their numbers. The parameter defines the scene number to be transmitted when the button is pressed.
Scene number (1 ... 8)	1...8	This parameter defines the number of the internal scene which is recalled or stored when a button is pressed.
The following parameters are only valid for the pushbutton function "2-channel operation"...		
Operation concept	Channel 1 or channel 2 Channel 1 and channel 2	This parameter defines the 2-channel operation concept. If the setting "Channel 1 or channel 2" is selected, the pushbutton sensor decides dependent on the button-press duration which of the channels will be used. If the setting "Channel 1 and channel 2" is selected, the pushbutton sensor transmits only the telegram of channel 1 on a short button-press and both telegrams on a sustained button-press.
Function channel 1 (2)	No function Switching (1 bit) Value transmitter 0 ... 255 (1-byte) Value transmitter 0 ... 100 % (1-byte) Temperature value transmitter (2 bytes)	This parameter defines the channel function and specifies which other parameters and which communication object are to be displayed for channel 1 (2).
Command of the button for channel 1 (2)	ON OFF TOGGLE	This parameter defines the object value transmitted to the bus when the button is pressed.

		This is only visible if "Function channel 1 (2) = Switching (1 bit)"!
Value of the button for Channel 1 (2) (0 ... 255)	0...255	This parameter defines the object value transmitted to the bus when the button is pressed. It is only visible if "Function channel 1 (2) = Value transmitter 0...255 (1 byte)"!
Value of the button for Channel 1 (2) (0 ... 100 %)	0...100	This parameter defines the object value transmitted to the bus when the button is pressed. It is only visible if "Function channel 1 (2) = Value transmitter 0...100 % (1 byte)"!
Temperature value of the button for channel 1 (2) (0 ... 40 °C)	0...40	This parameter defines the temperature value transmitted to the bus when the button is pressed. It is only visible if "Function channel 1 (2) = Temperature value transmitter (2 bytes)"!
Time between channel 1 and channel 2 (1 ... 255 x 100 ms)	0...30...255	Depending on the selected operation concept, this parameter defines the interval at which the pushbutton transmits the telegram for channel 1 and the telegram for channel 2 when the button is pressed.

The following parameters are only valid for the pushbutton function "Controller extension"...

Function	Operating mode switchover	A controller extension can optionally switch over the operating mode with normal or high priority, change the presence state or change the current room temperature value. With regard to the setting of this parameter, the ETS shows further parameters.
	Forced oper. mode switchover	
	Presence button	
	Setpoint shift	
Operating mode when the following button is pressed	Comfort mode	If the controller extension is to switch over the operating mode of the room thermostat with normal priority, the extension can – when actuated – either activate a defined mode of operation or change over between different modes of operation.
	Standby mode	
	Night mode	
	Frost/heat protection mode	
	Comfort mode ->	In order for this change to work properly,

	Standby mode -> Comfort mode -> Night mode ->	the controller extension should request the current state of the extension objects after a reset or after reprogramming (set parameter under "General" to "Value request from controller extension? = Yes").
	Standby mode -> Night mode ->	This parameter is only visible if "Function = operating mode switchover"!
	Comfort mode -> Standby mode -> Night mode ->	
Forced operating mode when the following button is pressed	Auto (Normal operating mode switchover)	If the controller extension is to switch over the operating mode of the room thermostat with high priority, the extension can – when actuated – either enable the switchover with normal priority (auto), switch on a defined mode of operation with a high priority or change over between different operating modes.
	Comfort mode	
	Standby mode	
	Night mode	
	Frost/heat protection mode	In order for this change to work properly, the controller extension should request the current state of the extension objects after a reset or after reprogramming (set parameter under "General" to "Value request from controller extension? = Yes").
	Comfort mode -> Standby mode ->	This parameter is only visible if "Function = forced operating mode switchover"!
	Comfort mode -> Night mode ->	
	Standby mode -> Night mode ->	
	Comfort mode -> Standby mode -> Night mode ->	
	Auto -> Comfort mode ->	
	Auto -> Standby mode ->	
Presence function when the following button is pressed	Presence OFF	On pressing a key, the controller extension can switch the presence state of the room thermostat either on or off in a defined way or change over between both states ("Presence TOGGLE").
	Presence ON	In order for this change to work properly, the controller extension should request the current state of the extension objects after a reset or after reprogramming (set parameter under "General" to "Value request from controller extension? = Yes").
	Presence TOGGLE	This parameter is only visible if "Function = presence button"!

Setpoint shift on pressing the button	Reduce setpoint value (level size)	This parameter defines the direction of the setpoint shift on the extension. For a setpoint value shift, the controller extension makes use of the two communication objects "Setpoint shift specification" and "Current setpoint shift". The "Current setpoint shift" communication object informs the extension about the current state of the room temperature controller. Based on this value and the respective parameter, the controller extension determines the new level size which it transmits via the "Setpoint shift specification" communication object to the room temperature controller. This parameter is only visible if "Function = Setpoint shift"!
	Increase setpoint value (level size)	

□ Button 2 ... Button n, see Button 1!

The following parameters are valid for the status LED of the buttons or rockers...

Function of the status LED *	Always OFF	Irrespective of the pushbutton or rocker function, the status LED is switched off permanently.
------------------------------	------------	--

*: For the rocker function separate parameters are present and configurable for the upper and lower status LEDs.

	Always ON	Irrespective of the pushbutton or rocker function, the status LED is switched on permanently.
--	-----------	---

	Button-press display	The status LED indicates a button actuation. The ON time is set on the parameter page "General" in common for all status LEDs that are configured as actuation displays.
--	----------------------	--

	Telegram acknowledgment	The status LED indicates the transmission of a telegram in 2-channel operation. This setting can only be configured for the pushbutton or rocker function "2-channel operation".
--	-------------------------	---

Status display (switching object)	The status LED indicates the state of the communication object "Switching". If the object value is "ON", the status LED is illuminated. If the object value is "OFF" the status LED is switched off. This setting can only be configured for the pushbutton or rocker function "Switching" or "Dimming".
Inverted status display (switching object)	The status LED indicates the state of the communication object "Switching". If the object value is "OFF", the status LED is illuminated. If the object value is "ON" the status LED is switched off. This setting can only be configured for the pushbutton or rocker function "Switching" or "Dimming".
Activation via separate LED object	The status LED indicates the state of its own, separate 1-bit LED object. This setting causes the additional parameter "Activation of the status LED via object value" to be shown.
Button function active display	The status LED indicates the state of the presence button in case of controller extension operation. The LED lights up if the presence function is activated. The LED is off if the presence function is inactive. This setting can only be configured in the pushbutton function "Controller extension" and with the button function "Presence button".
Button function inactive display	The status LED indicates the state of the presence button in case of controller extension operation. The LED lights up if the presence function is inactive. The LED is off if the presence function is activated. This setting can only be configured in the pushbutton function "Controller extension" and with the button function "Presence button".
Setpoint value shift display	The status LED indicates the state of a setpoint shift in case of controller extension operation. This setting causes the additional parameter "Status LED" to be shown. This setting can only be configured in the pushbutton function "Controller extension" and with the button function "Setpoint shift".

Operating mode display (KNX controller)	The status LED indicates the state of a KNX room thermostat via a separate 1-byte communication object. This setting causes the additional parameter "Status LED ON with" to be shown.
Controller status display (activate controller extension!)	The status LED indicates the state of the controller extension. This setting causes the additional parameter "Status LED ON with" to be shown.
Comparator without sign (1-byte)	The status LED is activated depending on a comparison. In this configuration there is a separate 1-byte communication object available via which the unsigned reference value (0...255) is received. This setting causes the additional parameter "Status LED ON with" to be shown.
Comparator with sign (1-byte)	The status LED is activated depending on a comparison. In this configuration there is a separate 1-byte communication object available via which the positive or negative reference value (-128...127) is received. This setting causes the additional parameter "Status LED ON with" to be shown.

The presettings of the parameter "Function of status LED" depend on the configured pushbutton or rocker function.

The function of the status LED = "Display via separate LED object"...

Activation of the status LED via object value

**1 = LED static ON /
0 = LED static OFF**

1 = LED static OFF /
0 = LED static ON

1 = LED flashes /
0 = LED static OFF

1 = LED static OFF /
0 = LED flashes

If the "Function of status LED ..." is set to "Control via separate LED object", then the telegram polarity of the 1-bit object "Status LED" can be specified at this point.

The LED can be switched on or off statically. In addition, the received switching telegram can be evaluated in such a way that the LED flashes.

If the function of status LED = "Operating mode display (KNX controller)"...

Status LED ON with Automatic mode
Comfort mode
Standby mode
Night mode
Frost/heat protection mode

The values of a communication object with data type 20.102 "HVAC Mode" are defined as follows:
0 = Automatic
1 = Comfort
2 = Standby
3 = Night
4 = Frost/heat protection

The value "Automatic" is used only by the "forced operating mode switchover" objects.

The status LED is illuminated when the object receives the value configured here.

The function of the status LED = "Controller status display"...

Status LED ON with **Comfort mode**
Standby mode
Night mode
Frost/heat protection mode
Controller disabled
Heating / cooling
Controller inactive (deadband operation)
Frost alarm

The "Controller status" communication object of the controller extension function includes eight bits of information in one byte. This parameter defines which bit is to be indicated by the LED.

The controller status can be displayed only if the controller extension is enabled (parameter page "General")!

If the function of status LED = "Comparator without sign"...

Status LED ON with **Reference value greater than received value**

Reference value less than received value

Reference value equal to received value

The status LED indicates whether the configured reference value is greater or less than or equal to the value of the "Status LED" object".

Reference value (0 ... 255)

0...255

This parameter defines the reference value to which the value of the "Status LED" object is compared.

If the function of status LED = "Comparator with sign"...

Status LED ON with **Reference value greater than received value**

Reference value less than received value

The status LED indicates whether the configured reference value is greater or less than or equal to the value of the "Status LED" object".

Reference value (-128 ... 127)	Reference value equal to received value -128... 0 ...127	This parameter defines the reference value to which the value of the "Status LED" object is compared.
☐↵ Disabling		
Disabling function?	Yes No	With this parameter, the disabling function of the pushbutton sensor can be activated centrally. If "Yes", the ETS shows further communication object and parameters.
Polarity of disabling object	Disable = 1 / Enable = 0 Disable = 0 / Enable = 1	This parameter defines the value of the disabling object at which the disabling function is active.
Reaction of pushbutton sensor at the beginning of the disabling function	No reaction Reaction as button >>X<< when pressed Reaction as button >>X<< when released Reaction as disabling function 1 when pressed Reaction as disabling function 1 when released Reaction as disabling function 2 when pressed Reaction as disabling function 2 when released Internal scene recall scene 1 Internal scene recall scene 2 Internal scene recall scene 3 Internal scene recall scene 4 Internal scene recall scene 5 Internal scene recall scene 6	Besides disabling of rocker and button functions, the pushbutton sensor can also and in addition trigger a specific function at the time of activation of the disabling state. This function can... correspond to the function assigned to any of the buttons in the non-disabled state ("Reaction as button >>X<< ..."), be defined on the following parameter pages ("Reaction as disabling function ..."), recall a scene stored internally in the pushbutton sensor ("Internal scene recall ...").

	Internal scene recall scene 7	
	Internal scene recall scene 8	
Button >>X<<	Button 1 Button 2 ... (Selection depends on device variant!)	If the pushbutton sensor is to perform the function of a specific button at the beginning of the disabling state, this button will be selected here. Visible only if "Reaction of pushbutton sensor at the beginning of the disabling function = Reaction as button >>X<< on pressing / releasing"!
Behaviour during active disabling	All buttons without function All buttons behave as Individual buttons without function Individual buttons behave as	While disabling is active... all buttons or only individually selected buttons can be disabled ("... no function"), all buttons or only individually selected buttons can be restricted to a specific function ("... behave as"). In this case, the ETS shows further parameters.
All left buttons with even numbers behave during disabling as	Button 1 Button 2 ... (Selection depends on device variant!) Disabling function 1 Disabling function 2	If a specific button function is to be assigned during disabling to all or to individual buttons, this parameter can be used to select the desired button the function of which will then be executed. During disabling, all the left buttons behave like the one configured here. The desired functions can either correspond to the function of an existing button or they can be configured as special disabling functions. This parameter is only visible if "Behaviour during active disabling = all buttons behave as" or "Behaviour during active disabling = individual buttons behave as"!
All right buttons with even numbers behave during disabling as	Button 1 Button 2 ... (Selection depends on device variant!) Disabling function 1 Disabling function 2	If a specific button function is to be assigned during disabling to all or to individual buttons, this parameter can be used to select the desired button the function of which will then be executed. During disabling, all the right buttons behave like the one configured here. The desired functions can either correspond to the function of an existing button or they can be configured as special disabling functions.

		This parameter is only visible if "Behaviour during active disabling = all buttons behave as" or "Behaviour during active disabling = individual buttons behave as"!
Reaction of pushbutton sensor at the end of disabling	No reaction Reaction as button >>Y<< when pressed Reaction as button >>Y<< when released Reaction as disabling function 1 when pressed Reaction as disabling function 1 when released Reaction as disabling function 2 when pressed Reaction as disabling function 2 when released Internal scene recall scene 1 Internal scene recall scene 2 Internal scene recall scene 3 Internal scene recall scene 4 Internal scene recall scene 5 Internal scene recall scene 6 Internal scene recall scene 7 Internal scene recall scene 8	Besides disabling of rocker and button functions, the pushbutton sensor can also trigger a special function immediately at the end of disabling. This function can... correspond to the function assigned to any of the buttons in the non-disabled state ("Reaction as button >>X<< ..."), be defined on the following parameter pages ("Reaction as disabling function ..."), recall a scene stored internally in the pushbutton sensor ("Internal scene recall ...").
Button >>Y<<	Button 1 Button 2 ... (Selection depends on device variant!)	If the pushbutton sensor is to perform the function of a specific button at the end of the disabling state, this button will be selected here. Visible only if "Reaction of pushbutton sensor at the end of disabling = Reaction as button >>Y<< on pressing /

releasing"!

Disable - Button selection (Visible only if "Behaviour during active disabling = individual buttons without function" or "Behaviour during active disabling = individual buttons behave as"!)

Selection of the buttons
for behaviour during
disabling

Button 1 ?	Yes No	The user can specify for each button separately whether it will be affected by the disabling function during the disabling state.
Button 2?	Yes No	

...

(Selection depends on
device variant!)

Disabling function 1 disable / Disabling function 2 disable. With the exception of the status LED control, the parameters available for the two disabling functions are the same as those for the button functions.

Scenes / scene data types (name of parameter page changes with scene function activated).

Scene function ?	Yes No	The pushbutton sensor can handle internally eight scenes with eight actuator groups. This parameter activates the scene function and the other parameters and communication objects, if needed.
------------------	------------------	---

Overwrite scene values during ETS download	Yes No	If the values of the actuator groups that have been changed on site by the customer are to be reset to the values preset in the ETS during an application download by the ETS, the setting "Yes" must be chosen. If "No" is selected, the ETS values will not overwrite the scene values stored in the pushbutton sensor, if any.
--	------------------	---

Data types Scene output 1	Switching Value (0 ... 255) Value / position of Venetian blind (0 ... 100 %)	The pushbutton sensor has an independent communication object for each of the eight actuator groups. With these parameters, the object type can be set separately for each output.
------------------------------	---	--

... Scene output 8	Switching Value (0 ... 255) Value / position of Venetian blind (0 ... 100 %)
-----------------------	---

□ Scene 1

Recall via extension object with scene number	1...64	If the internal scenes are to be recalled via the extension object, a definite number is required for each of them. This parameter serves to specify the extension number of the first scene. If several internal scenes have the same scene number, only the first scene with this number can be called up.
Scene output 1 Switching command	ON OFF	This parameter can be used to predefine the switching command of the first scene output. This parameter is only visible if "Data types scene output 1 = switching"!
Scene output 1 Value (0 ... 255)	0...255	This parameter can be used to predefine the value of the first scene output. This parameter is only visible if "Data types scene output 1 = switching"!
Scene output 1 Value / position of Venetian blind (0 ... 100 %)	0...100	This parameter can be used to predefine the value of the first scene output. This parameter is only visible if "Data types scene output 1 = switching"!
Scene output 1 Allow save?	Yes No	If the user is to be given the possibility of changing the value of the actuator group (scene output) within this scene and of storing it during regular operation, this parameter must be set to "Yes".
Scene output 1 Allow transmission?	Yes No	If the state of an actuator group is to remain unchanged during the recall of a scene, this parameter can be set to "No". In this case, the pushbutton sensor does not transmit a telegram via the scene output concerned during the recall of the scene. The scene output is deactivated for this scene.
Scene output 1 Transmit delay (1 ... 1200 * 100 ms) (0 = deactivated)	0...1200	When the pushbutton sensor sends the telegrams to the various scene outputs, it can insert a presettable waiting time of 2 min. max. before each telegram. This can be used to reduce bus loading, but also to have certain lamps switched on only after the shutters are really

		closed.
		If no delay is selected, the pushbutton sensor sends the output telegrams with maximum speed. With this setting it may happen in some cases that the telegram sequence is not compatible with output numbering.
Scene outputs 2 ... 8 see scene output 1!		
<input type="checkbox"/> Scenes 2 ... 8 see scene 1!		
<input type="checkbox"/> Alarm signalling		
Alarm signal display	Activated Deactivated	This parameter can be used to enable alarm signal displaying. When alarm signalling is enabled, the ETS displays further parameters and up to two further communication objects.
Polarity of the alarm signalling object	Alarm when ON and alarm reset when OFF Alarm when OFF and alarm reset when ON	The alarm signalling object is used as an input for activating or deactivating alarm signal displaying. If the object value corresponds to the "Alarm" state, all status LEDs and the operation LEDs flash with a frequency of approx. 2 Hz. If the setting is "Alarm when OFF and alarm reset when ON", the object must first be actively written by the bus with "0" to activate the alarm after a reset. An alarm signal is not stored so that the alarm signalling is generally deactivated after a reset or after programming with the ETS.
Reset alarm signalling by a button-press?	Yes No	If this parameter is set to "Yes", active alarm signal displaying can be deactivated by a button-press on the pushbutton sensor. This button-press does not cause the configured function of the pressed button to be executed. Only after then next button-press will the configuration of the button be evaluated and a telegram be transmitted to the bus, if applicable. If "No" has been selected, alarm signalling can only be deactivated via the alarm signalling object. A button-press will always execute the configured button function.

Use the alarm acknowledge object?	Yes No	<p>If alarm signalling can be deactivated by a button-press, this parameter defines whether an additional alarm acknowledge telegram is to be transmitted to the bus via the separate object "Alarm signalling acknowledge" after triggering by this button-press.</p> <p>A telegram can, for instance, be sent via this object to the "Alarm signalling" objects of other pushbutton sensors in order to reset the alarm status there as well (observe the polarity of the acknowledge object!).</p>
Acknowledge alarm signalling by	OFF telegram ON telegram	<p>This parameter sets the polarity of the "Alarm signalling acknowledge" object. This parameter presetting depends on the selected polarity of the alarm signalling object.</p>

5 Appendix

5.1 Index

A	
alarm.....	60
C	
Configuration.....	52
controller extension.....	55
D	
Delivery state and non runnable application ..	61
Dimming.....	35
E	
ETS project design and start-up.....	15
ETS search paths.....	11
F	
Fitting and connecting the device.....	7
Full-surface operation.....	30
I	
Introduction.....	49
L	
Loading the physical address and application software ..	8
O	
Objects for scene function:.....	27
Operating area as button function.....	30
Operating area as rocker function.....	29
Operating areas.....	6, 9
Operation LED.....	33
S	
Scene function.....	49
Scope of functions.....	13
Status LED.....	46
Switching.....	34
T	
Transmission delay.....	33
V	
value transmitter.....	41
Venetian blind.....	37

Berker GmbH & Co. KG
Klagebach 38
58579 Schalksmühle/Germany
Telefon + 49 (0) 2355/905-0
Telefax + 49 (0) 2355/905-111
www.berker.de