

**KNX radio shutter timer quicklink**

Order-No. 8574 51 ..



Berker GmbH & Co. KG  
Zum Gunterstal  
66440 Blieskastel/Germany  
Tel.: +49 6842 945 0  
Fax: +49 6842 945 4625  
E-Mail: info@berker.de

www.berker.com

05/2022  
BLE008041A

**KNX Radio shutter timer quicklink**

**Safety instructions**

Electrical equipment must only be installed and assembled by a qualified electrician in accordance with the relevant installation standards, regulations, directives and safety and accident prevention directives of the country.

Failure to comply with these installation instructions may result in damage to the device, fire or other hazards.

The radio transmission is not suitable for safety or alarm applications.

These instructions are an integral component of the product, and must be retained by the end user.

**Design of the device**

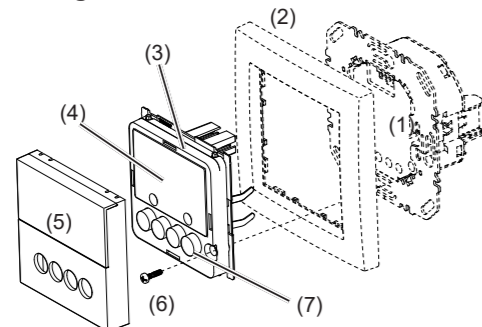

Figure 1: Design of the device

- (1) Insert (see „Accessories“, not in scope of delivery)
- (2) Frame (not in scope of delivery)
- (3) Application module
- (4) Display
- (5) Design cover
- (6) Screw for dismantling protection (not for design lines R.1/R.3)
- (7) Operation buttons

**Function**

This device is a product of the quicklink system, in which installation devices communicate via radio signals.

quicklink stands for a configuration mode in which the function-related connection between transmitters and receivers is set on the device through push-buttons and displays without further tools.

All devices configurable by quicklink can be operated together in one system.

This device is compliant to the R&TTE-Directive 1999/5/EG. The Declaration of Conformity and further system information can be found on our homepage www.berker.de.

The device may be used in all EU and EFTA countries.

**Correct use**

- Application module for shutter inserts or power supply for radio application modules
- Manual, time-controlled and automatic operation of blind/shutter motors connected to insert
- Transmission and reception of manual, time-controlled and automatic operation commands via quicklink
- Unsuitable for lighting control
- Only suitable for use in indoor areas, no drip or spray water

The quicklink configuration of the devices must only be carried out by qualified electricians.

**Product characteristics**

- quicklink functions for integration into the remote and group control of blinds/shutters

- Integration into scenes
- Two preset standard time programmes, individually adjustable
- Astro programme for automatic operation at dawn/dusk
- Astro time shift to adjust the operation times
- Holiday programme for random operation times in automatic mode
- Party programme to prevent unintentional operation of the shutters by automated operation commands as well as radio/extension unit commands
- Keylock
- Automatic switching to standard/daylight saving time
- Brightness-dependent operation when using a radio sun sensor

**Performance after mains breakdown/return of mains supply**

- Mains breakdown: Saving of the current configuration and programming in the non-volatile memory. The device then switches to economy mode. Only the internal clock continues to run to keep the time up-to-date. The use of a buffer memory ensures that the time stays up-to-date for up to 24 hours.
- Return of mains supply: The application module executes an initialisation operation<sup>1)</sup>, the basic display is restored. The stored configuration and programming is loaded from the memory. Any operations pending when the power supply broke down will not be executed after return of mains supply. If the buffer memory is full, date and time must be entered again.

**Operation**

**Operating concept and display elements**

When controlling the shutter, the buttons (Fig. 2) distinguish between a short press and a long press of > 0.5 seconds on the button.

Pressing the button for > 2 seconds can trigger various functions within the menu operation.

The current clock status is shown in the display. Active functions are displayed by using symbols (Table 1). Display illumination is activated for as soon as a button is pressed.

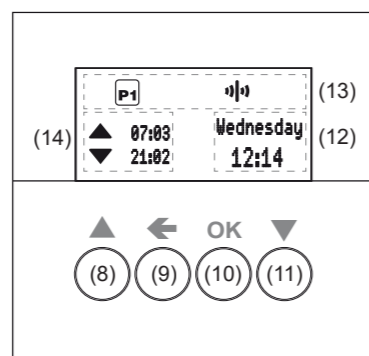

Figure 2: Display and operating elements

- (8) UP button ▲
- (9) Back button ◀
- (10) OK button
- (11) DOWN button ▼
- (12) Display area for weekday and time
- (13) Display area for active functions/programming
- (14) Display area for the next operation times

Symbol	Function
	Keylock active
	Manual operation, no automatic operation times
	Preset programme P1 (week programme) or P2 (week/weekend programme) is active
	Astro programme is active, UP and DOWN operation times are controlled depending on dawn/dusk times
	Party programme is active, manual operation only. Programmes, extension units and radio commands are not executed
	Normal radio operation is active, radio commands for master or group controls can be transmitted and received
	Standalone programme, Device has temporarily been removed from higher-level master controls, but can still be active in a group control
	Holiday programme, Random variation of operation times, only possible in combination with P1, P2, Astro
	Device is in radio configuration mode

Table 1: Symbols in the function/programme line (13) of the display

**Operate shutter - operation from the basic display**

Manual shutter operation is possible at any time from the basic display, even if automatic programmes are active. Operation may however be locked (see locking/unlocking operation).

- Press the ▲ or ▼ button.  
Short press on button: Adjustment of the slat position.  
Long press on button (> 0.5 s): Lock, shutter moves to final position.
- The max. operation time upon a long press on the button is 2 minutes.
- Short press on ▲ or ▼ button during the shutter movement.  
The shutter stops at the position reached.
- If a protection signal (wind, rain) is present, no move commands are executed (see Setting Operating Mode).

**Locking/unlocking operation**

The operation buttons of the shutter timer can be locked, in order to prevent unintentional operation, e.g. by children.

The shutter timer shows the basic display.

- Press the ◀ button for more than 5 seconds.  
The lock symbol is shown in the display. The operation buttons are locked.
- Press the ◀ button again for more than 5 seconds.  
The lock symbol disappears in the display. The operation buttons are enabled.

**Opening the menu and navigating**

The shutter timer is set and programmed via the menu.

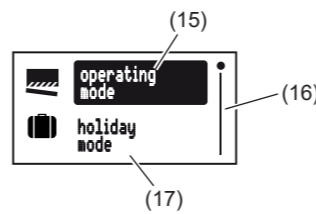

Fig. 3: Main menu

- (15) Selected menu item
- (16) Position display of the selected menu item in the list of options
- (17) Next option in the list

- Short press on any button.  
Operation is activated. The display is illuminated.
- Press the OK button for more than 2 seconds.  
The main menu is displayed. The first menu item **operating mode** (Fig. 3, 15) is highlighted dark.
- Press the ▲ or ▼ button to navigate through the menu.  
The selected menu item is highlighted dark.
- Confirm the selected option by pressing OK.  
The submenu opens.
- Navigation through the menus can continue as described above.
- Press the ◀ button.  
The display switches to the previous contents. To return to the basic display, press the ◀ button multiple times as necessary.

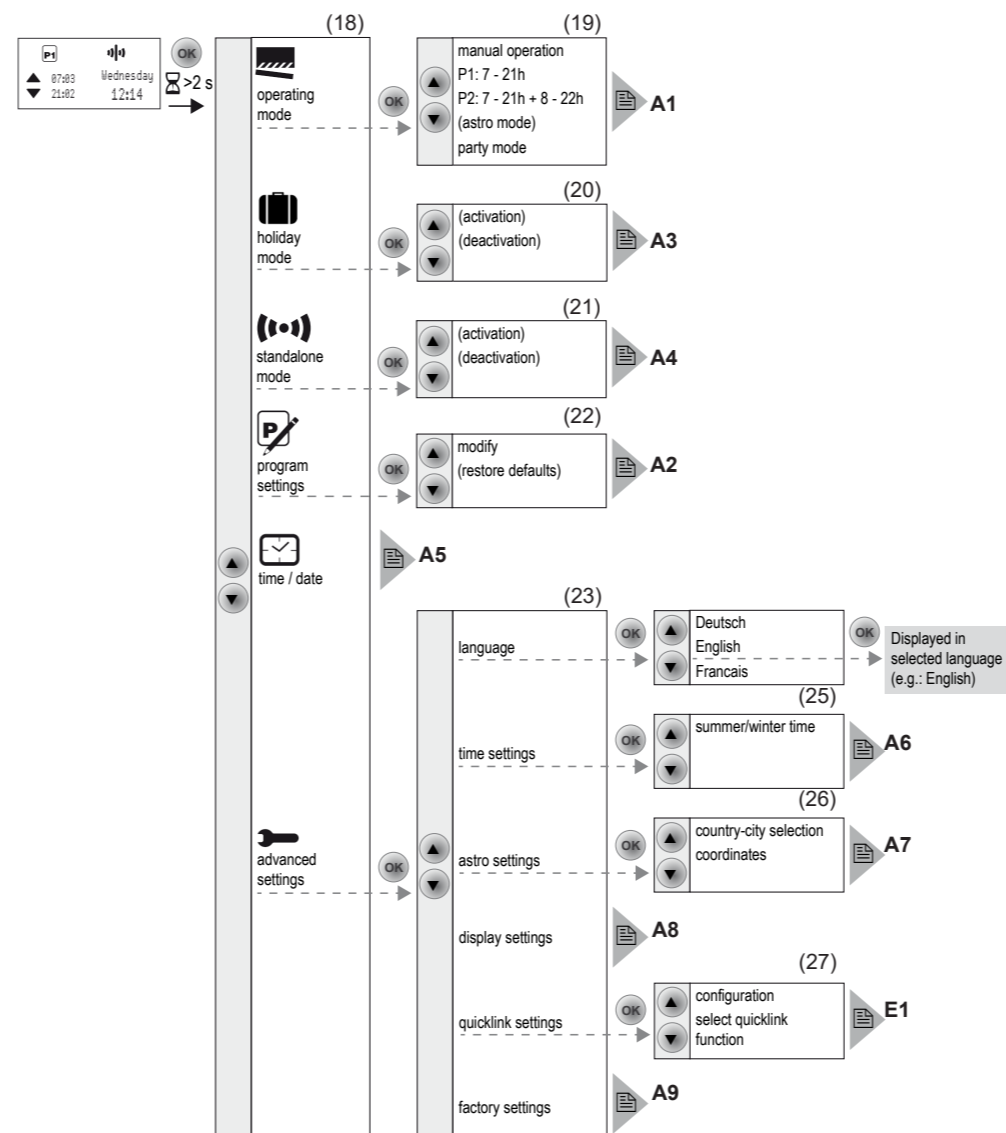

Figure 4: Menu overview

- If no button is pressed for a period of two minutes, the display returns to the basic display. Figure 4 shows an overview of the functions in the menus/submenus: **A..** for the user and **E..** for the electrician refer to sections for additional information. Menu items in brackets are visible depending on the timer programming status.

**Setting the values**

Values, such as time or date, have to be set first for the programming of some functions.

The value to be set is selected and is highlighted dark.

- Press the ▲ or ▼ button.  
Short press on button: Change the value by one step.  
Keep button pressed: Scroll through values. Scrolling stops when the button is released.

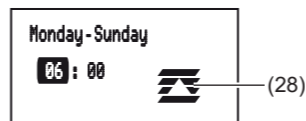

- If operation times are set, then a symbol (28) shows whether it is an UP or DOWN operation time.
- Press the OK button.  
The set value is applied.
- Press the ◀ button.  
The display switches to the previous value. The setting is not applied.

**Submenu A1 - Select programme**

One can choose between the following programmes:

- **manual operation:**  
Operation takes place solely using the buttons (see Operate shutter - operation from the basic display).
- Time programmes **P1: 7 - 21 h** and **P2: 7 - 21 h + 8 - 22 h**:  
These programmes are factory preset but can be changed individually.  
**P1** is a week programme with identical operation times for each day, **P2** is a week/weekend programme with different operation times for Mon. - Fri. and Sat. - Sun.

- **astro mode:**

Programme for dawn/dusk-dependent control of the shutters (see submenu A7 - Setup Astro programme).

The **astro mode** is only displayed if it has been set up.

- **party mode:**

The Party programme prevents unintentional operation of the controlled blinds/shutters by programmed operation time or extension unit operation, e.g. to prevent people from being shut out by the shutter going down.

When the Party programme is active, a blind/shutter can only be operated manually using the buttons on the timer. Control of the shutter via high-level control-sections and sensors as well as by extension units, radio and forced control commands is deactivated. Control of the shutter by higher-level control-sections and sensors as well as by extension units, radio and forced control commands is deactivated. If the blind/shutter was moved to a defined position in **forced mode** (see Table 4) and this forced mode is active, then the Party programme cannot be selected.

The shutter timer shows the Programme selection submenu (Fig. 4, 19). The most recently selected programme is highlighted dark.

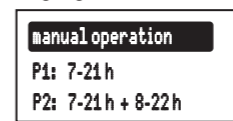

- Press the ▲ or ▼ button to select the desired programme.
- Press the OK button.

The screen switches to the basic display. The selected programme is run, the corresponding symbol (Table 1) is shown in the display (Fig. 2, 13).

**Submenu A2 - Change, delete or add to programmes**

The options **modify** and **restore defaults** (Figure 4, 22) can be used for the preset factory programmes:

- **modify** to adapt, add to or delete operation times. A maximum of 20 operation times per day are possible.
- **restore defaults** to reset a modified programme to the factory default programming.

Switching times can only be edited individually under **modify**. It is not possible to edit programme blocks (e.g. Mon. - Fri.).

- Press the ▲ or ▼ button to select options or to change the values.
- Press the OK button.

Short press on button: Confirmation of the current selection or the set value.

Long press on button (> 2 s) in programme editing: Adding an extra switching time or deletion of an existing switching time.



- Press the ◀ button.  
Short press on button: The display switches to the last content.  
Long press on button (> 2 s): Programming is completed, the switching times are skipped. Changes can be saved or rejected.

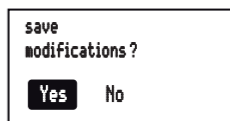

Should no DOWN operation time follow an UP operation time, or vice-versa, then the user is informed on the display before saving, that switching times are missing. Saving is nevertheless possible.

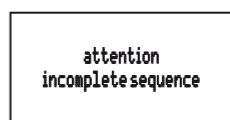

**Submenu A3 - Activating/deactivating Holiday programme**

The Holiday programme is a simple form of the presence simulation. The operation times of an existing programme (P1, P2, Astro) are varied, randomly, by ± 15 minutes. If operation times are too close together (difference < 15 minutes), then they are not varied.

The shutter timer can be found in the submenu **holiday mode** (Fig. 4, 20).

■ **Confirm activation with OK.**

The screen switches to the basic display and the symbol for **holiday mode** is displayed (Fig. 2, 13).

or:

■ **Confirm deactivation with OK.**

The screen switches to the basic display and the symbol for **holiday mode** is hidden in the display.

**Submenu A4 - Activating/deactivating Stand-alone programme**

The Stand-alone programme can be used for radio installations, in which the shutter timer was assigned to a master shutter control as a subordinate control. In Stand-alone operation the device ignores the radio commands of higher-level master controls and forced control commands, as well as extension unit signals, i.e. operation commands concerning the local blind/shutter are not executed.

If the blind/shutter was moved to a defined position in **forced mode** (see Table 4) and if this forced mode is active, then the Stand-alone programme cannot be selected.

The shutter timer can be found in the submenu **standalone mode** (Fig. 4, 21).

■ **Confirm activation with OK.**

The screen switches to the basic display and the symbol for **standalone mode** is displayed (Fig. 2, 13).

or:

■ **Confirm deactivation with OK.**

The screen switches to the basic display and the symbol for normal radio operation is displayed (Fig. 2, 13).

**Submenu A5 - Set time/date**

In the main menu (Fig. 4, 18), **time/date** is highlighted dark.

- Short press on **OK** button.  
The hour display as an active element is highlighted dark.
- Set the date and time (see Setting values).  
When all the setting options have been run through, the screen returns to the basic display.

**Submenu A6 - Set time options**

The automatic switching to standard/daylight saving time can be activated or deactivated for the shutter timer.

The submenu **time settings** is displayed (Fig. 4, 25).

- Confirm the **summer/winter time** option by pressing **OK**.

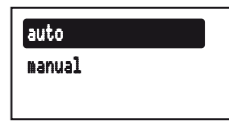

- Press the buttons ▲ or ▼ to select the required setting and confirm by pressing **OK**.

The device applies the setting and returns to the submenu **time settings**.

**Submenu A7 - Setup Astro programme**

The Astro programme leads to a dusk/dawn dependent control of shutters, meaning that automatic operation time adjustment occurs according to the season. As these operation times can be very early or very late, the Astro programme offers enhanced options in order to adapt the operation time.

- Deviation from dawn time by ± 120 minutes
- Deviation from dusk time by ± 120 minutes
- Earliest UP operation time (**earliest up time**)  
No operation times are executed before the earliest UP time, as defined by dawn. The blind moves UP at the time set here.
- Astro operation times after the set time are executed normally.

Example:

Set time	Sunrise	Executed operation time
<b>earliest up time</b>		
06:15	07:32	07:32
	05:23	06:15

- Latest DOWN operation time (**latest down time**)  
No operation times are executed after the latest DOWN operation time, as defined by dusk. The shutter moves DOWN at the time set here.
- Astro operation times before the set time are executed normally.

Example:

Set time	Sundown	Executed operation time
<b>latest down time</b>		
20:00	17:42	17:42
	21:12	20:00

The installation location must be set to determine the correct Astro operation times.

- Country/city selection:  
Simple setting option by selecting a country and a city near the location from a comprehensive list of European cities.
- The setting is made by entering the geographic co-ordinates and time zone of the location.

If the location is outside Europe or a high level of accuracy is required for the Astro operation times, then the setting should be made using the co-ordinates.

The submenu **astro settings** is displayed (Fig. 4, 26).

- Press the buttons ▲ or ▼ to select the setting type and confirm by pressing **OK**.  
The country/city selection and the co-ordinate settings are displayed.



- Set the location and times (see Setting values). Run through all the setting options.

Having confirmed the **latest down time** time, a query is displayed.

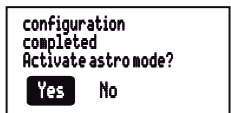

- Press the buttons ▲ or ▼ to select the required option and confirm by pressing **OK**.

**Yes:** The screen switches to the basic display. The Astro programme is run and the symbol ☼ is displayed (Figure 2, 13). The Astro settings are saved and Astro is added to the programme selection (Fig. 4, 18).

**No:** The screen switches to the basic display. The Astro settings are saved and **astro mode** is added to the programme selection (Fig. 4, 18) but is not run.

#### Submenu A8 - Set display contrast

In the submenu advanced settings (Fig. 4, 23), **display settings** is highlighted dark.

- Short press on **OK** button.

The current contrast value as an active element is highlighted dark.



- Set the location and times (see Setting values).

Having made the setting, the display returns to the Basic setting submenu.

#### Submenu A9 - Resetting the device to the factory settings

**i** In the factory setting, both the user's settings, such as programmes or Astro settings, are reset and all the configured radio logic functions deleted.

In the submenu advanced settings (Fig. 4, 23), **factory settings** is highlighted dark.

- Press the **OK** button for more than 10 seconds.

During initialisation, the display shows ☼ and then switches to Start-up mode. Language, time and date must be reset.

### Information for electricians

#### Installation

##### Selecting installation location

A minimum distance between the transmitter and corresponding receiver of about 1 m must be maintained.

A minimum distance to electronic devices which emit high frequency signals such as computers, electronic transformers or microwave devices of approx. 0.5 m must be maintained.

Mounting on or close to metal surfaces may cause impairment of the radio transmission.

Take material penetration into account. The range of the system can be optimised by selecting the best possible mounting location:

Material	Degree of material penetration
Wood, plaster, plasterboard, uncoated glass	approx. 90 %
Brick, press boards	approx. 70 %
Reinforced concrete, floor heating	approx. 30 %
Metal, metal grids, aluminium laminates, coated glass	approx. 10 %
Rain, snow	approx. 1 ... 40 %

Table 2: Material penetration

#### Assembly of the device (Figure 1)

The insert is installed (see operating instructions for the insert).

- Attach the application module (3) together with frame (2) to a suitable insert (1) so that the contact pins are inserted into the available jack.

As soon as voltage is supplied to the application module, the display indicates whether the application module and the insert are compatible with each other:

Display text	Meaning
(Operating mode indicator)	Compatible
Invalid Power Module	Not compatible
Invalid or defective Power Module!	Incompatible or missing supply voltage. Check the insert and replace as necessary.
Changed Power Module / Reset to factory?	Compatible, but not configured to each other. Direct reset of the radio configuration to the factory setting possible by keeping (10 s) the <b>OK</b> button pressed. User settings (e.g. times, programmes) remain set.

Table 3: Insert/application module compatibility

- If available, fix dismantling protection with screw (4).
- Click design cover (5 or 6) into place on application module (3).

#### Start-up

##### First start-up

The device initialises itself when the mains voltage is switched on for the first time. Insert detection is carried out and, if an incompatible device is found, a message is displayed (see Table 3). Then an hourglass and the manufacturer's logo are displayed.

The language selection is displayed, the first language is highlighted dark.



- Set language, time and date (see Setting values).

The device switches to the basic display and is ready for operation.

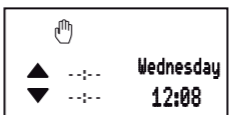

**i** While the basic display is displayed, the operating mode can be changed up to 30 s after detecting the insert at the latest if necessary (see Setting Operating Mode).

#### Setting Operating Mode

It is possible to change between two operating modes during the first 30 s of the commissioning:

- Protection Mode (factory setting): Mode for using sensors on the extension unit inputs of the insert to protect against wind or rain damage on outside blinds/awnings.

In protection mode no move commands are executed while a signal (wind /rain sensor) is present on the extension unit input.

- Manual Mode:

The last move command is executed regardless of whether or not it takes place locally or via an extension unit.

The basic display is displayed.

- Hold button ▲ and ▼ simultaneously for approx. 5 s until the display changes.

The operating mode is changed and displayed:

**Priority extension line up enabled** display: The protection mode is set.

or:

**Priority extension line up disabled** display: The manual mode is set.

**i** In normal operation, the operating mode can no longer be changed and displayed after 30 s have expired.

Configurable function	Display text	Function resulting from transmitter operation, notes
▲	Move UP, stop	up Long press on button: move the shutter to the top final position. Short press on button: slat adjustment of shutters Short press on button during shutter operation: stop
▼	Move DOWN, stop	down Long press on button: move the shutter to the bottom final position. Short press on button: slat adjustment of shutters Short press on button during shutter operation: stop
1	Scene 1	scene 1 Receiver is allocated to a scene due to the configuration of the function. Receivers are allocated to a scene due to the configuration of the function.
2	Scene 2	scene 2 Short press on button: loading the shutter position saved in the scene.
UP/DOWN (switch)	up/down (switch)	Device is assigned to a transmitter as a shutter switch. Up/down function is configured in one configuration operation.
UP forced mode	forced up	Moves the shutter to the appropriate final position with higher-level priority. The execution of other commands .
DOWN forced mode	forced down	
X	Delete	delete Deletion of the configuration

<sup>1)</sup> Preconfigured local function (see operation).

Table 4: Configurable functions

### Submenu E1 - Radio configuration quicklink

The radio configuration sets the functional connection between commanding (transmitters) and function-executing (receivers) radio components. Thus wireless e.g. central unit, group, extension unit and time controls can be realised.

The following can be configured:

- The local operation of the load connected to the insert
- Radio commands to control other receivers
- Functions that are executed when radio commands are received

**i** For configuration by means of Hager connection device TX100 or ETS, additional functions are available (see operating instructions for TX100 or application description for ETS).

#### Configuring the radio shutter timer as a receiver

Configuration to control the load connected to the insert via reception of a radio command (Table 4).

As an example, the configuration of a wall-transmitter and the radio shutter timer as receiver is described down below (Table 5).

**i** If the message **Connection error** is displayed during configuration, this indicates an impossible combination or an error. Reset the message by pressing **OK**.

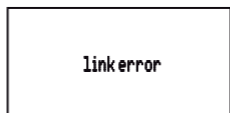

#### Configuring the radio shutter timer as a transmitter

The following radio command for activation of receiver functions is supported:

- ◆ UP/DOWN (switch)  
The device is configured for shutter operation of a compatible receiver. Both buttons are assigned using a teach-in operation. The device serves as a master. Active shutter timer programmes are also run on the receivers.

As an example, the configuration of the radio shutter timer with a radio shutter push-button is shown here (Table 6). Different configuration displays, such as for receivers with display, are to be taken from the receiver operating instructions.

#### Deleting a configuration

To delete a configured receiver or the local operation, execute the configuration again.

- **Start configuration** (see configuration of the radio shutter timer as a receiver).

- If necessary, **Select transmitter button**.

**i** If the radio shutter push-button functions as a transmitter, the step **Select transmitter button** does not apply.

- **Select function on receiver**.

- **Confirm the function on the receiver:** press the ▲ or ▼ button, select **delete** and confirm with **OK**.

An hourglass displays the logic function operation. The successful deletion of the logic function is then displayed.

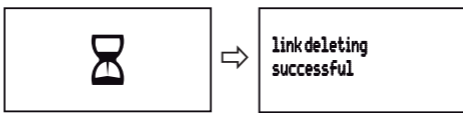

Step	Result
<b>Start configuration</b>	
<ul style="list-style-type: none"> <li>■ Short press on <b>cfg</b> button on the wall transmitter.</li> </ul>	<p>The <b>cfg</b> LED on the wall-transmitter blinks red. <b>Cfg</b> (Table 1) is shown in the display of the shutter timer.</p> <p>All receivers within radio range also indicate the configuration mode.</p>
<b>Select transmitter button</b>	
<ul style="list-style-type: none"> <li>■ Short press on press-activation point on the wall-transmitter which should activate the function.</li> </ul>	<p>The <b>cfg</b> LED on the wall transmitter blinks for 1 second.</p>
<b>Select function on receiver</b>	
<ul style="list-style-type: none"> <li>■ Open the <b>quicklink setting</b> menu (see Opening the menu and navigating).</li> </ul>	
<ul style="list-style-type: none"> <li>■ Press the buttons ▲ or ▼ to select the <b>quicklink function</b> and confirm by pressing <b>OK</b>.</li> </ul>	<p>A list of possible functions is displayed.</p> <p><b>i</b> If the transmitter button has already been configured with a function in a different receiver and/or the configured function is part of a group control, only this function can be configured. To change a function, the existing configuration must be deleted and the new one needs to be configured.</p>
<b>Confirming function on receiver</b>	
<ul style="list-style-type: none"> <li>■ Press the buttons ▲ or ▼ to select the required function and confirm by pressing <b>OK</b>.</li> </ul>	<p>An hourglass displays the logic function operation. The successful execution of the configuration is then displayed.</p>
<ul style="list-style-type: none"> <li>■ Confirm the message with <b>OK</b>.</li> </ul>	<p>The <b>quicklink setting</b> menu is displayed. The ☼ symbol indicates that a logic function was set up.</p>
<b>Finish configuration</b>	
<ul style="list-style-type: none"> <li>■ Short press on <b>cfg</b> button on the wall transmitter again.</li> </ul>	<p>The <b>cfg</b> LEDs on the radio wall-transmitter and all receivers within radio range go out. The <b>Cfg</b> display on the screen of the radio shutter timer goes out. The function is configured.</p>

Table 5: Configuring the function for the radio shutter timer

- Confirm the message with **OK**.

The quicklink setting menu is displayed. The logic function symbol ☼ is removed.

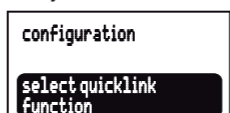

- **Finish configuration:** Short press on the **cfg** button the transmitter.

#### Configuration of group functions

By means of a group function, one transmitter controls several receivers. To do so, the same functions must be configured on all receivers.

- **Start configuration** (see configuration of the radio shutter timer as a receiver).

- If necessary, **Select transmitter button**.

**i** If the radio shutter push-button functions as a transmitter, the step **Select transmitter button** does not apply.

Step	Result
<b>Start configuration</b>	
<ul style="list-style-type: none"> <li>■ Open the <b>quicklink settings</b> menu (see Opening the menu and navigating).</li> </ul>	
<ul style="list-style-type: none"> <li>■ Confirm <b>configuration with OK</b>.</li> </ul>	<p>The menu for activating the configuration is displayed. Configuration mode is inactive.</p>
<ul style="list-style-type: none"> <li>■ Press the buttons ▲ or ▼ to select <b>cfg On</b> and confirm by pressing <b>OK</b>.</li> </ul> <p><b>i</b> If there is no further activation, the configuration is automatically ended after 10 minutes.</p>	<p>Configuration mode is active. The <b>cfg</b> LED of the shutter button light up in red colour.</p> <p>All receivers within radio range also indicate the configuration mode. If configured already, the <b>fct</b> LED of the shutter button indicates the configured function.</p>
<b>Selezionare funzione</b>	
<ul style="list-style-type: none"> <li>■ Select the DOWN/UP (switch) function on the shutter using the <b>fct</b> button (see operating instructions).</li> </ul>	<p>The <b>fct</b> LED blinks red and green.</p>
<b>Confermare la funzione</b>	
<ul style="list-style-type: none"> <li>■ To save the allocation of command and function, keep the <b>fct</b> button of the shutter button pressed for more than 2 seconds.</li> </ul>	<p>The <b>cfg</b> LED blinks. After successful saving, the <b>fct</b> LED blinks red and green.</p>
<b>Chiusura configurazione</b>	
<ul style="list-style-type: none"> <li>■ Press the buttons ▲ or ▼ to select <b>cfg Off</b> and confirm by pressing <b>OK</b>.</li> </ul>	<p>The <b>cfg</b> LEDs on the shutter button and all receivers within radio range go out. The radio command for the timer has been configured.</p>

Table 6: Configuring the radio shutter timer as a transmitter

- **Finish configuration:** Short press on the **cfg** button the transmitter.

#### Setting the shutter position for scenes

If the timer is assigned to a scene as a receiver, then the shutter position can be set for this scene.

- Move the shutter to the top final position and wait for two minutes.

- Move the shutter downwards to the desired position.

- Set the desired slat position by pressing the button briefly several times (max. 30 UP steps).

- Keep transmitter button belonging to the configured scene command pressed for more than 5 seconds.

The shutter moves up for a second and then down for a second. The scene position has been saved.

### Appendix

#### Technical data

Radio frequency	868 MHz
Radio protocol	KNX radio
Connection	Mounting on suitable inserts (see Accessories)

Power supply	via insert
quicklink logic functions/receivers	max. 20 transmitters/receivers

Receiver category	2
Transmitter duty cycle	< 1 %
Power reserve via internal storage battery	8 h
Charging time of the internal storage battery	48 h
Programmable operation times	max. 20 per day/140 in total

Change-over time	min. 600 ms
Shutter operating time	2 min
Slat angle adjustment time	250 ms
Relative humidity (no condensation)	0 ... 65 %
Ambient temperature	-5 ... +45 °C
Storage/transport temperature	-20 ... +60 °C

The Declaration of Conformity can be found on our Internet site.

#### Accessories

Shutter insert comfort	8522 11 00
Power supply for KNX radio application module	8502 01 00
KNX radio brightness sensor	8580 11 00

#### Web

Websites to determine the location's latitude/longitude:

- <http://www.active-value.de/geocoder/>
- <http://itouchmap.com/latlong.html>

#### Warranty

We reserve the right to make technical and formal changes to the product in the interest of technical progress.

Our products are under guarantee within the scope of the statutory provisions.

If you have a warranty claim, please contact the point of sale or ship the device postage free with a description of the fault to the appropriate regional representative.