

Application description	
--------------------------------	---

KNX room thermostat/room controller

Electrical/mechanical data: see the operating instructions for the product













































	Order number	Product designation	Application programme	TP product  Radio product 
	8044 01 00	KNX thermostat		
	8066 01 00	KNX room controller		

Table of contents

1. General	5
1.1 General information about this application description	5
1.2 Programming software configuration tool	5
1.3 Commissioning	5
2. Functional and device description	6
2.1 Device overview	6
2.2 Functional description	7
2.3 Operating concept	7
2.3.1 Operating instructions	9
2.3.2 Range of functions	9
2.4 Functional over of the room thermostat functions	10
2.4.1 Room thermostat 	10
2.5 Functional overview of the push-button functions	11
2.5.1 No function 	11
2.5.2 Lighting	11
2.5.3 Dimming	12
2.5.4 roller shutters	13
2.5.5 Heating/cooling	14
3. Project preparation	15
3.1 Project editing	15
3.2 Device choice	16
3.2.1 Menu field - parameters	16
3.3 Overview inputs/outputs	18
3.4 Parameterisation of background/display lighting	20
3.4.1 Function status LED	20
3.4.2 Background/display lighting 	20
4. Room thermostat function parameters	21
4.1 Heating/cooling 	21
4.2 Control types	23
4.2.1 2-point control	23
4.2.2 Switching PI-control (PWM)	24
4.3 Temperature sensor function parameters	26
4.3.1 Internal temperature sensor 	26
4.3.2 External temperature sensor 	26

5.	Room controller configuration	27
5.1	Push-button functions	27
5.2	Functions Lighting	29
5.2.1	Functions On  / Off 	29
5.2.2	ON/OFF" functions (buttons)	30
5.2.3	Toggle switch function.....	30
5.2.4	Timer function 	30
5.2.5	Functions priority toggle On  / Off 	31
5.2.6	Scene function 	32
5.2.7	Automatic control deactivation toggle 	33
5.2.8	Overview of all possible linking combinations.....	34
5.3	Dimming functions.....	36
5.3.1	Functions Dimming Up (ON)  / Down (Off) 	36
5.3.2	Functions Dimming Up/Down 	36
5.3.3	Function Dimming 	37
5.3.4	Up/down dimmer switch 	37
5.3.5	Scene function 	38
5.3.6	Automatic control deactivation toggle 	38
5.3.7	Overview of all possible linking combinations.....	39
5.4	4Roller shutter function	40
5.4.1	Basis roller shutter/blind control.....	40
5.4.2	Functions blinds up  / blinds down 	43
5.4.3	Functions roller shutter up  / roller shutter down 	43
5.4.4	Switch blinds up/down 	43
5.4.5	Switch roller shutters up/down 	43
5.4.6	Function roller shutter position 	44
5.4.7	Function slat angle 	45
5.4.8	Functions Roller shutter and slat position 	45
5.4.9	Functions Priority up toggle  / down toggle 	46
5.4.10	Scene function 	47
5.4.11	Automatic control deactivation toggle 	47
5.4.12	Overview of all possible linking combinations.....	48
5.5	Heating/cooling functions	49
5.5.1	Function Priority comfort toggle 	50
5.5.2	Function Priority protection toggle 	50
5.5.3	Scene function 	50
5.5.4	Automatic control deactivation toggle 	50
5.5.5	Overview of all possible linking combinations.....	51

6. Appendix.....	52
6.1 Technical data	52
6.2 Accessories.....	52
6.3 Warranty.....	53
7. Table of Figures.....	54
8. List of tables.....	56

1. General

1.1 General information about this application description

This document describes the programming and parameterisation of easy compliant KNX products with the aid of the *configuration tool*.

1.2 Programming software configuration tool

The application programs for the KNX products are already preinstalled in the configuration tool.

- i** If the current application software is not available in the configuration tool, then the configuration tool must be updated (see "Configuration tool" installation handbook).

1.3 Commissioning

The commissioning process for the devices refers primarily to the heating/cooling type setting and the linking of the buttons (hereinafter inputs) and the switch actuator outputs (hereinafter outputs) as well as the selection of the respective push-button functions (switching, dimming, roller shutter/blind, etc.).

- i** The commissioning process for the configuration tool can be found in the corresponding instructions.
- i** Programming with the configuration tool is restricted to just one bus line and does not require a line coupler. As a result, it is possible to combine wired and wireless-network (quicklink ) KNX devices.

2. Functional and device description

2.1 Device overview

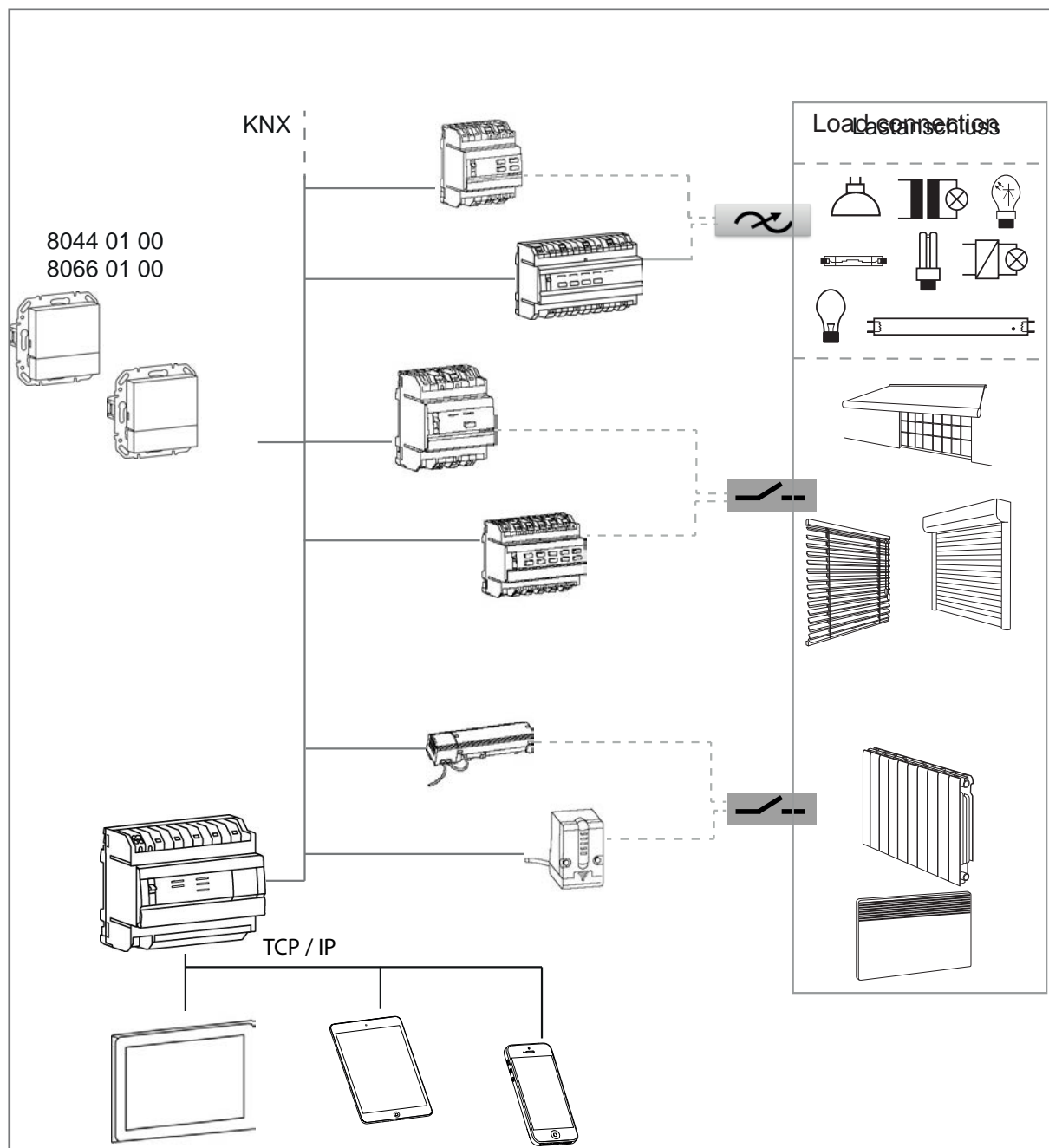

Figure 1: Device overview

2.2 Functional description

The **KNX thermostat** can be used to control the temperature of individual rooms. In the course of this, the command value for heating or cooling is sent to the bus depending on the operating mode and room temperature.

The **KNX thermostat** compares the current room temperature with the set temperature and controls heating and cooling devices according to the current requirements.

The **KNX room controller** also has push-button functions. The following functions can be assigned to the inputs:

- Switching
- Dimming
- Blind/roller shutter
- Scene
- Priority
- Heating/cooling

Depending on the parameterised functions, telegrams that trigger ON/OFF, dimming, blind/shutter functions, call up or save light scenes and set dimming, brightness or temperature values in the corresponding actuators are transmitted to the KNX system bus when touch control surface is pressed. The assignment of the various functions is freely selectable for each input and is defined by parameterisation.

2.3 Operating concept

The function of the individual inputs depends on the programming of the devices. The room controller can also have up to 9 assigned push-button functions.

Button/input

A thermostat or a push-button function is designated as the input respectively.

The device is subdivided into a display area (1) and a control surface area (2). On the page "Basic display" symbols indicate the set/active parameters in the upper row of the display. The lower row of the display area changes its display depending on the page. Symbols indicate the functions that can be triggered using the touch control surface (2) below. Greyed out symbols indicate a deactivated function.

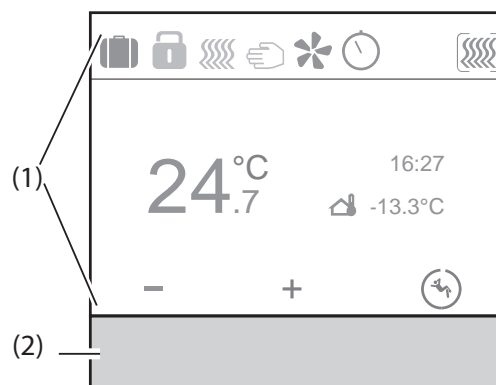

Figure 2: Display elements

- (1) Display area
- (2) Operating area

– Push-button operation:

The stored function is executed by pressing the touch control surface below the displayed symbol (3).

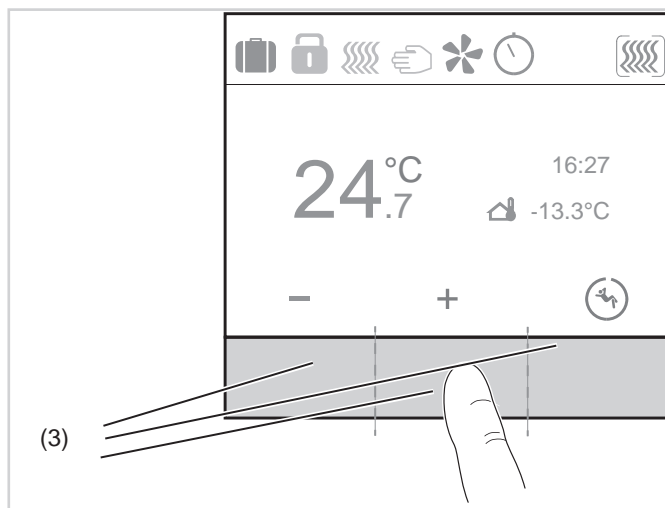

Figure 3: Push-button operation operating concept

(3) Push-button zones

– Slider operation:

The respective pages are navigated to by "swiping" over the capacitive touch control surface (4). Here, the movement can take place from left to right or reverse direction. The swiping action on a submenu page brings you back to the main page.

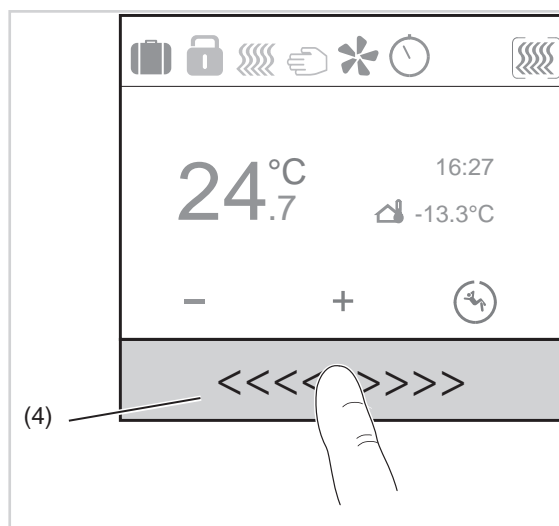

Figure 4: Slider operation operating concept

(4) Slider control surface

2.3.1 Operating instructions

The device differentiates between short and long touches.

- Short touch operation
 - Switch lighting
 - Shutter/blind step operation
- Long touch operation
 - Dimming the lighting
 - Move command (move) roller shutter/blind
 - Saving of a scene

2.3.2 Range of functions

- A function can be assigned to each input.
- Each individual input can be used for one function from lighting, dimming, roller shutter, heating/cooling.

Lighting:

Each input can be assigned one of the following functions: "On, Off, Switching, Toggle switch, Timer, Priority on/off toggle, Scene, Deactivate automatic control toggle".

Dimming:

Each input can be assigned one of the following functions: "Dimming up (on), Dimming down (off), Dimming up/down, Dimming, Dimming (dimming value in %), Up/down dimmer switch, Scene and Automatic control deactivation toggle".

Roller shutter:

Each input can be assigned one of the following functions: "Blind/roller shutter up/down, Roller shutter position, Slat angle, Roller shutter and slat position, Priority up/down toggle, Scene and Automatic control deactivation toggle".

Heating/cooling:

Each input can be assigned one of the following functions: "Priority comfort toggle, Priority protection toggle, Scene and Automatic control deactivation toggle".

- The basic display can be customised (display of time, date, screen saver type, internal/ outside temperature etc.).
- The device has an internal temperature sensor and connecting terminals for an external temperature sensor. In addition, the room temperature can be measured, processed and sent to the bus.

2.4 Functional over of the room thermostat functions

The functions described in the following section enable the individual configuration of the room thermostat functions (RTR).

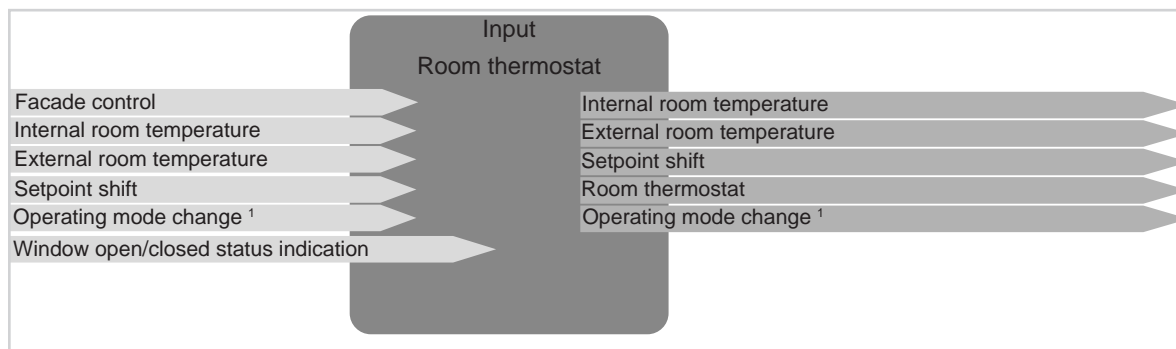

Figure 5:

¹ Operating modes: Comfort , Standby , Eco , Frost/heat protection

2.4.1 Room thermostat

Control mode

Users select the type of system to be controlled (heating, cooling, heating and cooling) in the **Control mode**.

Type of basic heating

Users select the type of heating (warm water heating, floor heating, electric heating, etc.) for the control level (normal operation) **Type of basic heating**.

Type of basic heating control

Users select the control type (switching 2-point or switching PI control) in the **Type of basic heating control** parameter.

Type of basic cooling

Users select the type of cooling (ceiling cooling, split unit, etc.) for the control level (normal operation) **Type of basic cooling**.

Type of basic cooling control

Users select the control type (switching 2-point or switching PI control) in the **Type of basic heating control** parameter.

2.5 Functional overview of the push-button functions

The functions described in the following section enable the individual configuration of the device inputs or outputs.

i These functions can only be configured in the room controller device.

2.5.1 No function

The **No function** function means that no function is assigned to the button. The button is disabled.

2.5.2 Lighting

On / Off

With the **On/Off** function, the lighting is switched on or off when the relevant configured button is pressed.

Switching (push-button function)

The **Switching** function is a button function which causes the device to send a "1-command" to the bus when the button is pressed and a "0-command" when the button is released.

Toggle switch

The **Toggle switch** function switches on the lighting upon the first key-press and switches it off again upon the second.

Timer

The **Timer** function enables the actuator output to be switched on for an adjustable duration. The switching time can be interrupted before the delay time elapses. An adjustable switch-off warning signals the end of the delay time by inverting the output state for 1 s.

Priority toggle (On / Off)

The **Priority** function makes it possible to specify a defined state or to force a defined state of the function.

Scene

In the **Scene** function, several switching/dimming/blind outputs can be grouped together and switched on/off at the touch of a button. A maximum of 8 scenes can be created.

Automatic control deactivation toggle

This function can be used for time-controlled switching, interrupting and deactivating of ongoing operations, e.g. lighting.

Communication commands Lighting function

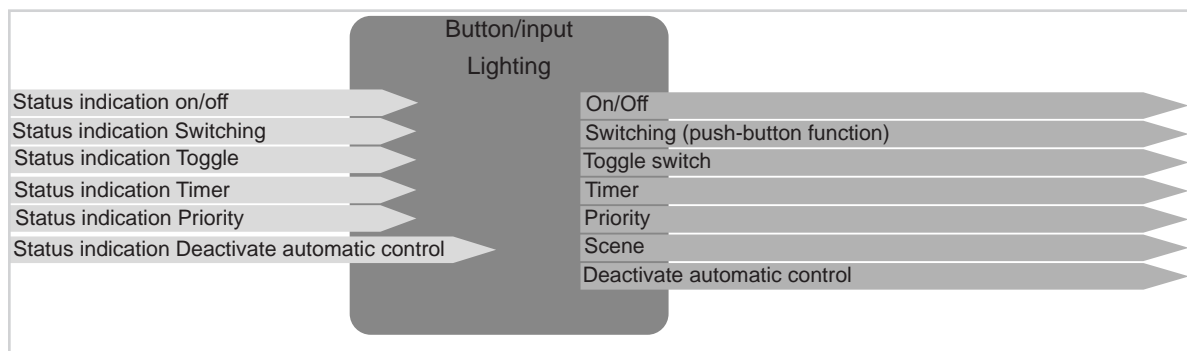

Figure 6: Input/output signals Lighting function

2.5.3 Dimming

Dimming up (on) / Dimming down (off)

With the **Dimming up (On) down (Off)** function, the lighting or lighting circuit can be dimmed up or down (long press of the button) or switched on or off (short press of the button) by pressing the relevant configured button.

Dimming Up/Down

With the **Dimming up/down** function, the lighting can be dimmed up/down with the same button.

Dimming (Dimming value %)

The lighting is assigned a certain brightness value with the **Dimming (dimming value %)** function.

Up/down dimmer switch

The lighting can be dimmed up or down (long press of the button) or switched on/off (short press of the button) with the **Dimmer switch up/down** function, and it can also be switched on/off via a third button (toggle operation).

Scene

In the **Scene** function, several switching/dimming/blind outputs can be grouped together and switched on/off at the touch of a button. A maximum of 8 scenes can be created.

Automatic control deactivation toggle

This function can be used for time-controlled switching, interrupting and deactivating of ongoing operations, e.g. lighting.

Communication commands Function dimming

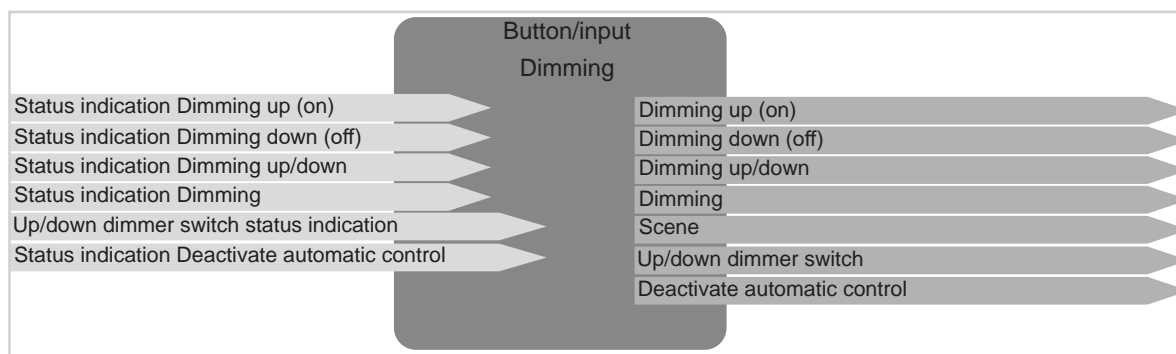

Figure 7: Input/output signals Dimming function

i All functions from the **Lighting** function group can be linked with a dimming output. However, only the relevant **switching command** is executed in the switch output.

2.5.4 roller shutters

The **shutter** function allows blinds, shutters, awnings or similar hangings to be opened and closed.

Roller shutters up / down - Blinds up / down

With these functions, it is possible to move a roller shutter/blind up/down or to open/close an awning, for example, by pressing the button.

Position roller shutter / roller shutter and slat / Slat angle

With these functions, it is possible to set the position of the roller shutter/blind or the angle of the slat by pressing the button.

Blinds up/down / Roller shutters up/down

With these functions, it is possible to move a roller shutter/blind up/down or to open/close an awning, for example, by pressing the button.

Priority up toggle / down toggle

With these functions, it is possible to impose the up/down command in a roller shutter/blind actuator by pressing the button; in other words, the position that is currently set is interrupted and Priority mode is switched on. The Priority function makes it possible to specify a defined state or to force a defined state of the function., Example: window cleaner function.

Scene

In the **Scene** function, several switching/dimming/blind outputs can be grouped together and switched on/off at the touch of a button. A maximum of 8 scenes can be created.

Automatic control deactivation toggle

This function can be used for time-controlled switching, interrupting and deactivating of ongoing operations, e.g. blinds.

Communication commands Function roller shutter

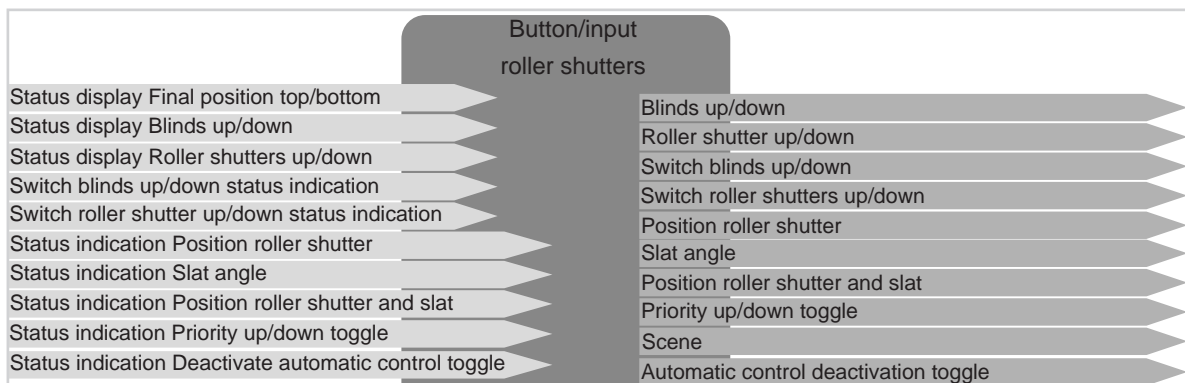





Figure 8: Input/output signals Roller shutter function

2.5.5 Heating/cooling

Operating mode

- Comfort mode 
- Eco mode 
- Standby mode 
- Protection mode 

With one of these functions, it is possible to switch on/toggle the relevant operating mode – Comfort, Eco, Standby or Protection – by pressing the button.

Priority comfort toggle / Priority protection toggle

With one of these functions, it is possible to impose the Comfort/Protection mode in a thermostat by pressing the button; in other words, the Heating/cooling function which is currently running is interrupted and Priority mode is switched on. The Priority function makes it possible to specify a defined state or to force a defined state of the function.

Scene

In the **Scene** function, several switching/dimming/blind outputs can be grouped together and switched on/off at the touch of a button. A maximum of 8 scenes can be created.

Automatic control deactivation toggle

This function can be used for time-controlled switching and deactivating of ongoing operations, e.g. changing between heating/cooling.

Communication commands Heating/cooling function

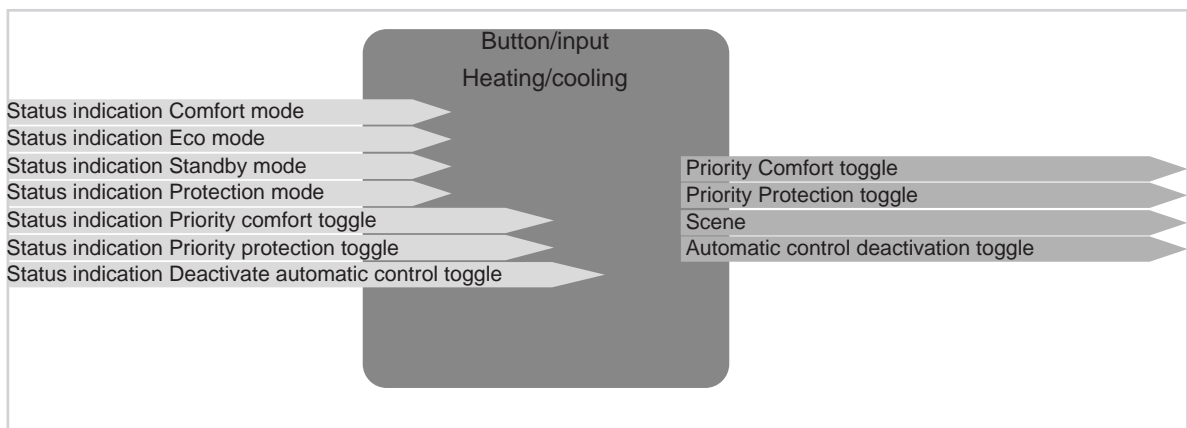





Figure 9: Input/output signals Heating/cooling function

3. Project preparation

The configuration of the parameters for the room thermostat and room controller devices are described in the following sections. The only difference between the functions of the devices relates to their push-button functions. For this reason, the room controller with the push-button function is described in this document.

-  The parameters which are set on the display can be found in the operating instructions of the device. These parameters are not discussed further in this document.
-  The room thermostat functions are the same in the room thermostat and the room controller.
-  Parameterisation and commissioning are carried out using the **configuration tool**.

If all devices are integrated into the project, then you can start configuring the device.

-  The set parameters are updated continuously during the configuration.

3.1 Project editing

To ensure that the commissioning process with the **configuration tool** is successful, the following requirements must be met:

- ✓ A network connection to the **configuration tool** has been established.
- ✓ All of the devices used (wired and wireless) are connected to the **configuration tool**.
- ✓ Start the **configuration tool** software (browser version or tablet app).
- ✓ Create the project and enter the project-specific data (project name, address, customer data).
- ✓ Click on search to scan devices.

The **configuration tool** has scanned the device and started with the parameterisation.

3.2 Device choice

First of all, the corresponding device must be selected in the device listing to make it possible to start with the configuration.

- Select **KNX room thermostat/room controller device with TFT display** in the device overview with a mouse click.

The following view opens (Figure 10).

All of the device inputs and device outputs are listed on the right-hand side (Figure 10, 1).

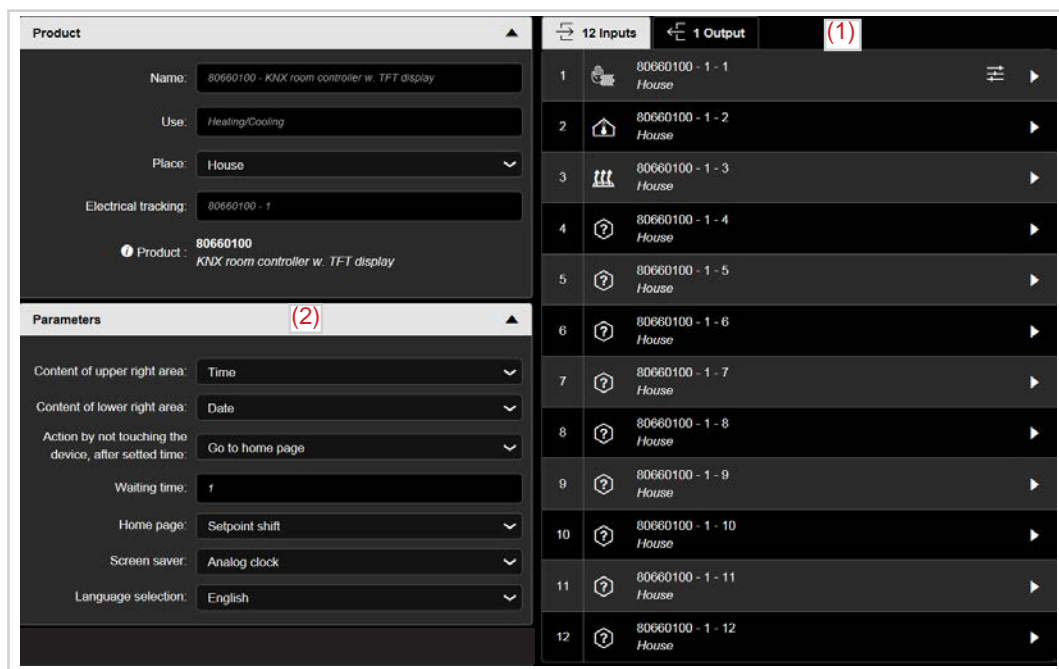

Figure 10: Device information

3.2.1 Menu field - parameters

The display settings must be set under Parameters (Figure 10.2). These settings must be set once. Here, for example, you can set the action if the device is not operated or the appearance during operation.

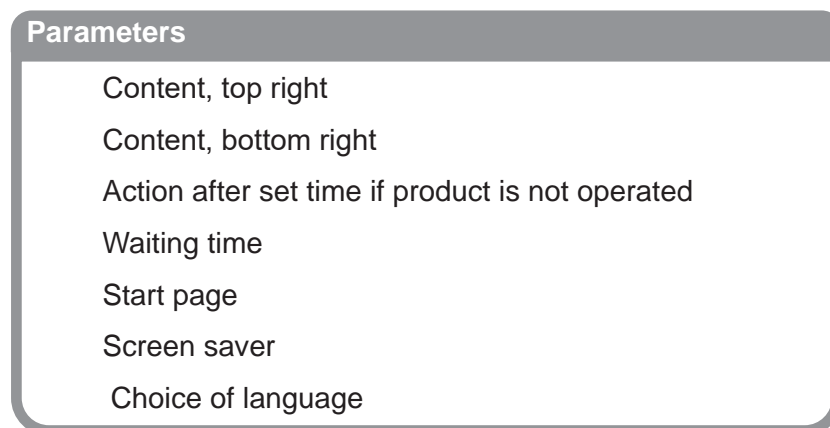

Figure 11: Display settings

Parameters	Description	Value
Content, top right	The selection determines which value should be displayed at the top right .	Nothing Date Time * Detection of outside temperature Setpoint
Content, bottom right	The selection determines which value should be displayed at the bottom right .	Nothing Date * Time Detection of outside temperature Setpoint
Action after set time if product is not operated	Determines what occurs if the device is not operated.	No change Go to start page * Go to start page + switch the display off Go to start page + set screen brightness to night mode Go to start page + screen saver
Waiting time	This value is used to set the time for switching to the Action when the product is not operated mode.	1 * ... 255 min
Start page	This parameter defines the start page of the device. The start page is the page that is displayed when, for example, the display remains untouched.	Base side * First push-button side
Screen saver	Determines which type of screen saver is set after the waiting time.	Analogue clock Digital clock * Logo Outside temperature + time Room temperature + time Operation help
Choice of language	Determines only one display language!	English * French German Italian Portuguese Spanish Dutch Swedish Danish Finnish Norwegian Turkish Polish

Table 1: Display setting

* Default value

3.3 Overview inputs/outputs

The number of device inputs and outputs is determined by the device type used.

The next figure shows the inputs for the room controller on the left-hand side and the outputs on the right-hand side.

















12 inputs		1 outputs	
	80660100 - 1 -1 *		80660100 - 1 -1 *
	House		House - lighting
	80440100 - 1 -1 *		80440100 - 1 -1 *
	House		House - lighting
	80660100 - 1 -2 *		
	House		
	80440100 - 1 -2 *		
	House		
	80660100 - 1 -3 *		
	House		
	80440100 - 1 -3 *		
	House		
	80660100 - 1 -4 **		
	House		
	80660100 - 1 -5 **		
	House		
	80660100 - 1 -6 **		
	House		
	80660100 - 1 -7 **		
	House		
	80660100 - 1 -8 **		
	House		
	80660100 - 1 -9 **		
	House		
	80660100 - 1 -10 **		
	House		
	80660100 - 1 -11 **		
	House		
	80660100 - 1 -12 **		
	House		

Figure 12: Overview inputs/outputs

The device described and pictured here features a total of 12 inputs and one output. The inputs are split into three inputs for the configuration of the temperature control/detection and in the actual inputs/buttons 4 – 12.

- Inputs/buttons 1 – 3 *
These inputs/buttons are assigned the "Temperature control, Room temperature and "Floor temperature" functions permanently.
- Inputs/buttons 4 – 12 **
The "Lighting – Dimming – Roller shutters – Heating/cooling" functions can be assigned to the inputs/buttons 4 - 12.

EASY application description

KNX room thermostat/room controller



Outputs refer to functions which are triggered by pressing another button or by timer functions, e.g. switching off the function of all display lighting on the device if necessary.

– Output 1: Display lighting FPL ***

The settings and function of the display lighting must be made in the parameters for output 1.

* These inputs/buttons are visible on the **thermostat and room controller** devices.

** These inputs/buttons are **only** visible on the **room controller** device.

*** FPL = Front Product Labelling

3.4 Parameterisation of background/display lighting

3.4.1 Function status LED

The device does not have status LEDs. The status indication of the functions appears on the display via the respective function symbol and is changed accordingly when the status changes.

3.4.2 Background/display lighting FPL

The background lighting FPL (display lighting) can be switched on and off via a link with, for example, a push-button and the respective set functions (on/off) (Figure 14).



Figure 13: Background/display lighting

Inputs			Outputs	
⏻	80142180 - 1 -1 <i>House</i>	⊕	FPL	80660100 - 1 -1 <i>House - lighting</i>
ⓘ	80142180 - 1 -2 <i>House</i>			

Figure 14: Switch off background/display lighting

4. Room thermostat function parameters

All the functions (heating/cooling, internal and external temperature sensors) of the **room thermostat** and **room controller** devices are described in the next two chapters. These functions are integrated into both types of devices (thermostat/room controller).

4.1 Heating/cooling

You can open the parameter window to configure the heating and/or cooling system by clicking on 80XX0100 - 1 - 1 .

The system settings (heating or cooling, or heating and cooling), the heating/cooling type and the control type of the various systems are listed in this parameter window.

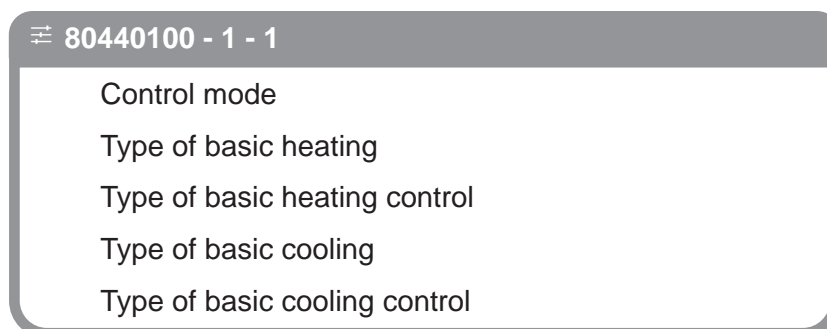

Figure 15: Heating/cooling settings

Parameters	Description	Value
Control mode	Determines the type of system.	Heating Cooling * Heating + cooling
Type of basic heating	This parameter determines the type of heating system.	Warm water heating * Warm water underfloor heating Electric heating Electric underfloor heating Convactor fan heating
Type of basic heating control	This parameter determines the control type.	Switching 2-point control * Switching PI control
Type of basic cooling	The type of cooling system is determined with this parameter.	Ceiling cooling * Convactor fan cooling dfffdsdfsdfsdfs
Type of basic cooling control	This parameter determines the control type.	Switching 2-point control * Switching PI control

Figure 16: Heating/cooling parameter

* Default value

















Inputs			Inputs	
 80440100 - 1 - 1 <i>House</i> 80660100 - 1 - 1 <i>House</i>			 Internal temperature sensor	
			 External temperature sensor	
			 Comfort mode	
			 ECO mode	
			 Standby mode	
			 Protection mode	
			 Automatic heating/cooling	
			 Heating/cooling switching	
			 Toggle Comfort/Eco	
			 Toggle Comfort/Standby	
			 Automatic Protection mode	
			 Setpoint shift	
			 Priority Comfort	
			 Priority Protection	
			 Status window	
			 Heating/cooling switching	
			 Heating/cooling toggle	
			 Automatic Comfort mode	
			 Automatic Eco mode	
			 Automatic Standby mode	
 Automatic mode switching				
 Scene				
 Scene switching				
 Deactivate automatic				
 Automatic control deactivation toggle				

Figure 17: Linking input – input **Heating/cooling**

4.2 Control types

The control types are designed for heating and cooling. The temperature setpoints are permanently stored in the software for both systems.

Operating mode	Heating setpoints
Comfort	+21°C
Standby	+19°C
Eco/Night	+16°C
Frost protection	+7°C

Table 2: Heating setpoints

Operating mode	Cooling setpoints
Comfort	+22°C
Standby	+23°C
Eco/Night	+27°C
Heat protection	+35°C

Table 3: Cooling setpoints

If the setpoints are exceeded or undershot, a reaction is caused in the connected heating actuator or the connected valve drive.

4.2.1 2-point control

The 2-point control or the 2-point controller is the simplest of the two controller types in terms of operation. The controller can only switch the thermostat on or off. The controller switches the output value on if the setpoint is undershot, or turns it off if the setpoint is exceeded (heating) (Figure 18).

The controller is equipped with an in-built hysteresis in order to prevent the it from constantly switching the output value on and off. The controller calculates the switch-on and switch-off points using the hysteresis and the current setpoint. The hysteresis value is also stored permanently and cannot be changed.

The 2-point controller should be used where the output value can only accept the two states ON or OFF and the actual temperature does not have to be controlled precisely to the setpoint.

Due to the inertia of the heating system, the actual temperature swings slightly below the set switch-on point and exceeds the set switch-off point slightly. The actual temperature therefore always fluctuates in the 2-point controller within a range which is slightly greater than the set hysteresis.

Application Example:

- Hot water heating
- Underfloor heating
- Ceiling cooling

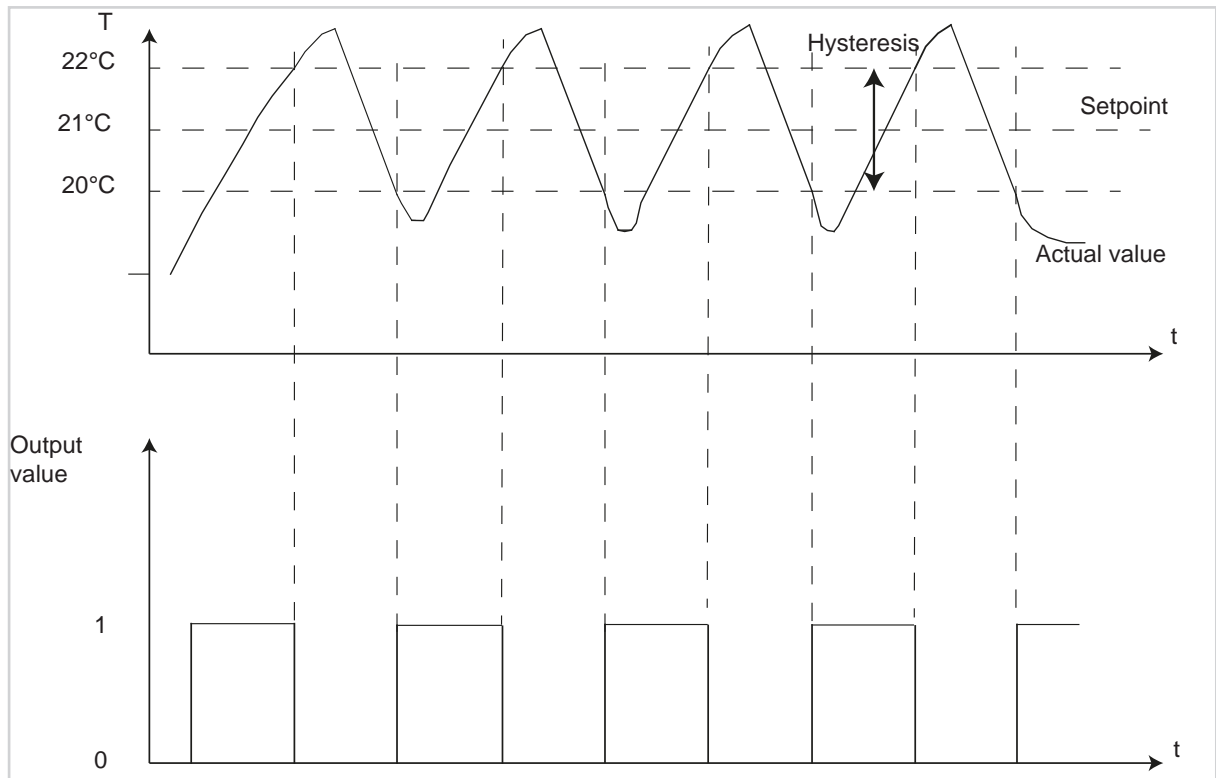

Figure 18: 2-point control

4.2.2 Switching PI-control (PWM)

The switching PI control (PWM), pulse wide modulation control, also has continuous PI control. However, with such a control, the output signal (0 to 100%) of the PI control is not passed on to the output value, but is only processed internally. 100% der PI-Regelung nicht an die Stellgröße weitergegeben, sondern nur intern verarbeitet. The PWM control subsequently converts the output value from the output signal of the PI control into a switch on/off pulse. However, this switch on/off pulse does not have a fixed switch on/off point as with the 2-point control, but the length of the pulses is determined by means of the output value calculated by the PI control (cycle time). The larger the calculated output value of the PI control, the greater is the ratio of the switch on/off times.

The cycle time is permanently stored in the system for the PWM control. The cycle time is the time which comprises a cycle, that is to say the duration of a switch on/off pulse (Figure 19). The duration of the switch-on pulse is calculated from the product of the calculated output value and cycle time, e.g. if the cycle time is 10 min and the calculated output value is 70%, the switch-on pulse is $0.7 \cdot 10 \text{ min} = 7 \text{ min}$. The remaining three minutes of the cycle therefore remain for the switch-off pulse. A short cycle time causes the switch-on pulses to occur at fairly short intervals. This prevents the temperature from sinking too much and the actual value remains largely stable. However, this can also lead to frequent switching pulses, which can adversely affect the system or can overload the bus.

The application area of the PWM control is where the advantages of the continuous PI control are required, but the heating system used can assume only the two states ON and OFF. The PWM control provides fairly good control results because it retains the advantages of continuous PI control (control to desired setpoint, no overshoot) in spite of limited switching states. One area of application is, for example, electro-thermal drives.

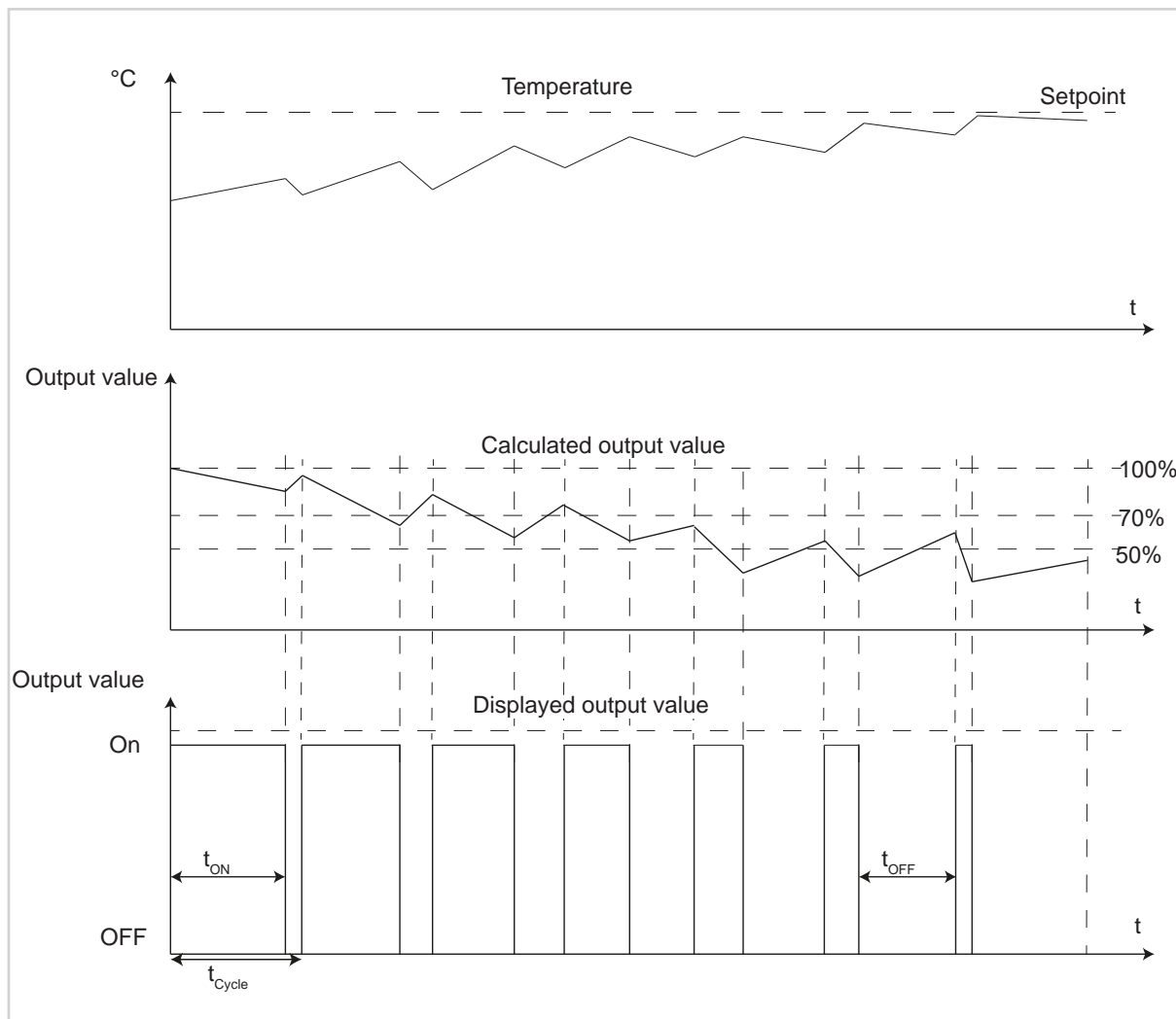

Figure 19: Switching PI-control (PWM)

4.3 Temperature sensor function parameters

The following section describes the configuration and parameterisation of the internal and external temperature sensor.

- Both temperature sensors can be activated/deactivated independently from one another, which means that they can also be parameterised separately.

4.3.1 Internal temperature sensor

The device is directly fitted with a sensor for temperature measurement.

- After commissioning, voltage loss or download of the application software it can take up to 30 minutes until the device has adapted to the ambient temperature and the internal temperature sensor delivers correct measured values.**

- The measured temperature can be transmitted directly to a KNX thermostat as a second measuring point (measurement result) and can be used to synchronise the global actual temperature (synchronisation in larger rooms).

- Room temperature recorded as a measurement result for a building visualisation.

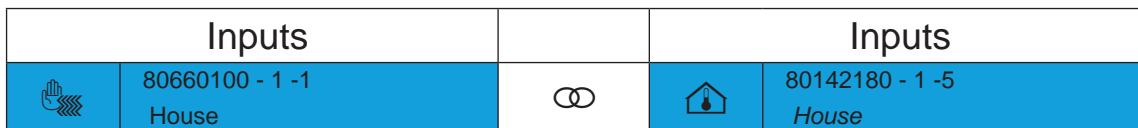

Figure 20: Linking input – input **Internal temperature sensor** function

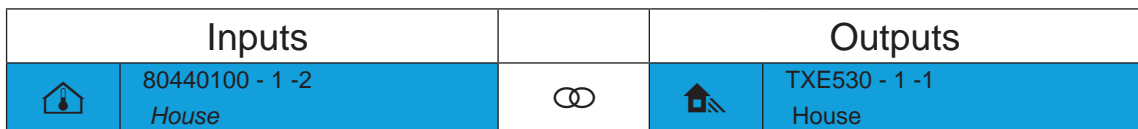

Figure 21: Linking input – output **Internal temperature sensor** function

4.3.2 External temperature sensor

The external temperature sensor is a cable-based remote sensor that can be connected to the device (see accessories) directly. The measured temperature is processed internally and is used to monitor the floor temperature in underfloor heating (protection against high temperature).

- The temperature measured externally can serve as a second measuring point (measurement result) (synchronisation in larger rooms).
- Recording, for example, the ambient temperature as the measurement result when installation is carried out in an unfavourable location (outside, etc.).

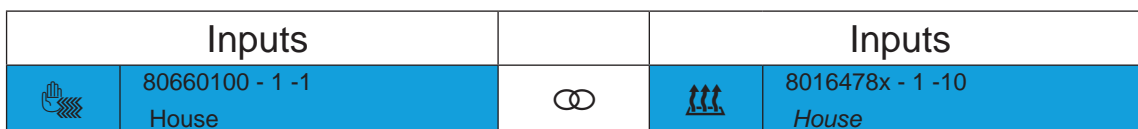

Figure 22: Linking input – input **External temperature sensor** function

When selecting an installation position for the device or the external sensor, observe the following:

- Integrating the push-button into multiple combinations should be avoided especially when a flush-mounted dimmer is also installed.
- The sensors should not be installed near to large electrical consumers (heat radiation).
- The device/sensor should not be installed near to heaters or cooling systems.
- The temperature sensor must be kept out of direct sunlight.
- Installing sensors on the inside of external walls may negatively influence the temperature measurement.
- Temperature sensors should be installed at least 30 cm away from doors and windows and at least 1.5 m above the floor.

5. Room controller configuration

The functions for lighting, dimming, roller shutters/blinds and heating/cooling are described in the following chapters. These functions are only visible and configurable in the **room controller** device.

5.1 Push-button functions

The configuration of the push-button functions is described in the following chapter. These functions are automatically linked with the respective function symbol and shown on the display. You can select and operate the functions by **swiping** and **pressing** the **touch control surface** (for more detail, see the operating instructions). The functions of the button/input are divided into the following function groups.

i These functions can **only** be configured in the **room controller** device.

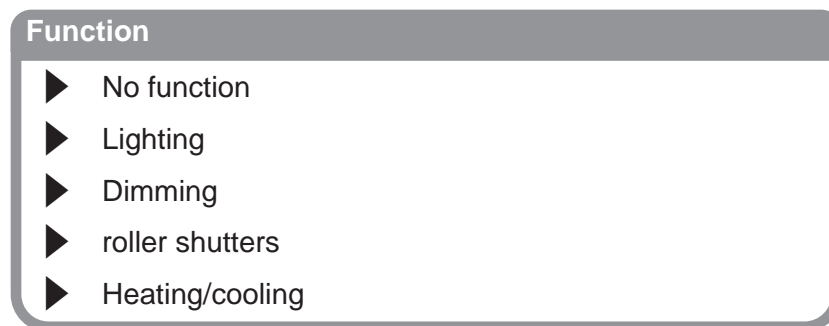



Figure 23: Function selection of the touch control surface

The **No Function** function  is preset at the beginning of the parameterisation. This means that the relevant button/input is not active.

The **Lighting, Dimming, Roller shutter** and **Heating/cooling** functions have different sub-functions, which are described in the following sections.

Parameters	Description	Value
No function	The input has no function (inactive).	
Lighting	This parameter sets the function of the individual button under Lighting .	On Off Switching (push-button function) Toggle Timer Priority toggle Scene Deactivate automatic control toggle
Dimming	This parameter sets the function of the individual button under Dimming .	Dimming up (on) Dimming down (off) Dimming up/down Dimming up/down dimmer switch Scene Automatic control deactivation toggle
roller shutters	This parameter sets the function of the individual button under Roller shutter .	Blind up Blind down Roller shutter up Roller shutter down Switch blind up/down Switch roller shutter up/down Roller shutter position Slat angle Roller shutter and slat position Priority up toggle Priority down toggle Scene Automatic control deactivation toggle
Heating/cooling	This parameter sets the function of the individual button under Heating/cooling .	Priority Comfort toggle Priority Protection toggle Scene Automatic control deactivation toggle

Table 4: Function of the touch operating surface

5.2 Functions Lighting

The "Lighting" function is used to switch the lighting or socket circuits on/off with a switch actuator.

i All of the combination possibilities between inputs – outputs/inputs are listed at the end of the chapter.

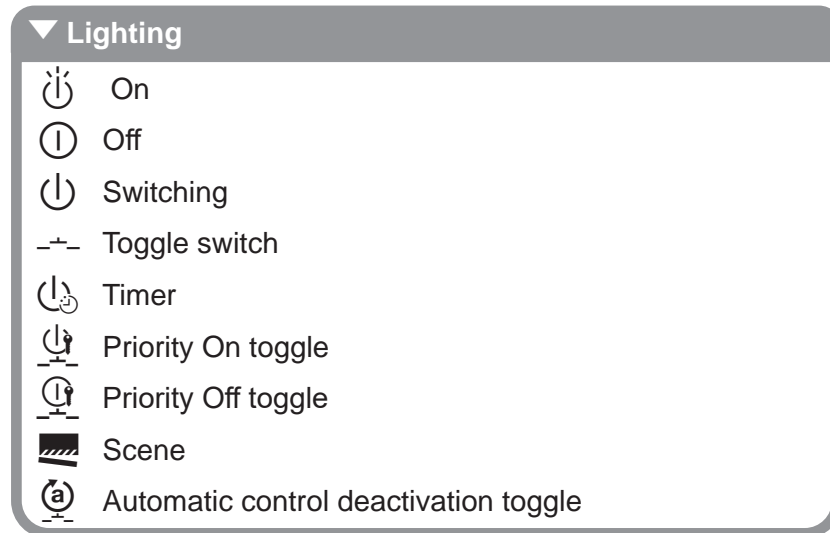

Figure 24: Functional overview lighting

5.2.1 Functions On / Off

The **On/Off** functions are used to control the lighting and socket circuits. The two adjacent buttons/inputs should be parameterised with the functions Lighting **On** and Lighting **Off** so that the lighting can be switched on and off by a key (Figure 25).





Inputs			Outputs	
	80660100 - 1 -5 <i>House</i>			TXA610 - 1 -3 House - lighting
	80660100 - 1 -4 <i>House</i>			

Figure 25: Linking function **On - Off**

5.2.2 ON/OFF" functions (buttons)

Pressing the button switches on the switch actuator channel and releasing the button switches it off again (push-button function). The function can be used to switch on an installation contactor/ self-retaining relay, for example (conventionally wired stairway timer or bell push-button).

Inputs			Outputs	
	80660100 - 1 -5 <i>House</i>			TXA610 - 1 -2 <i>House - lighting</i>

Figure 26: Linking Function **switching**

5.2.3 Toggle switch function

The "Toggle switch" function means changing over. When the "Toggle switch" function is active, pressing the same independent push-button triggers an alternate switching command.

Inputs			Outputs	
	80660100 - 1 -4 <i>House</i>			TXA610 - 1 -1 <i>House - lighting</i>

Figure 27: Linking **Toggle switch** function

5.2.4 Timer function

In the Timer function, when a short key-press occurs, the corresponding switch output is switched for the time set in the switch actuator. When a long key-press occurs, the ongoing timer operation is interrupted and the switch output is switched off.

Inputs			Outputs	
	80660100 - 1 -5 <i>House</i>			TXA610 - 1 -1 <i>House - lighting</i>

Figure 28: Linking **Timer** function

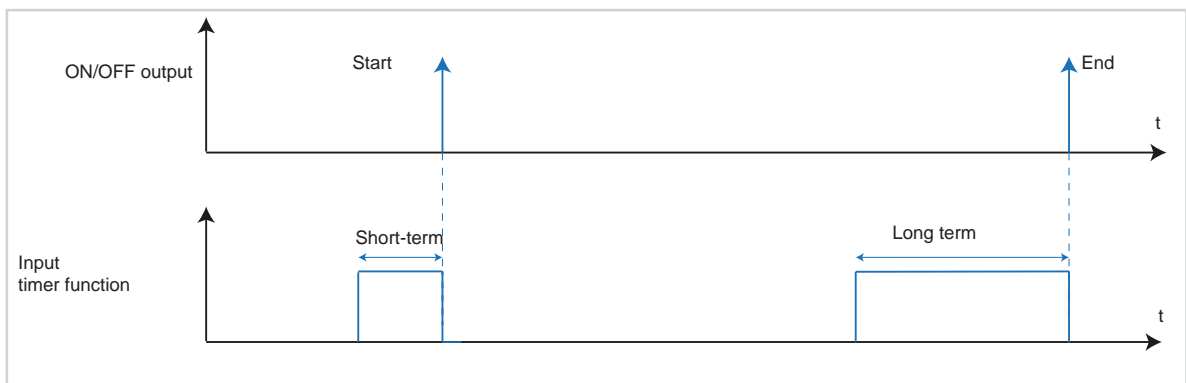

Figure 29: Signal-time diagram for timer

5.2.5 Functions priority toggle On / Off

This function allows a switch output to be forced to a switch position regardless of the switching signal (higher priority). As a result, the Priority can be switched on/off with the same button (toggle).

Inputs			Outputs	
	80660100 - 1 -5 <i>House</i>			TXA610 - 1 -1 <i>House - lighting</i>

Figure 30: Linking **Priority on toggle** function

Inputs			Outputs	
	80660100 - 1 -4 <i>House</i>			TXA610 - 1 -1 <i>House - lighting</i>

Figure 31: Linking **Priority off toggle** function

When "Priority" is active, incoming switch telegrams are still evaluated and the parameters set in the switch output are executed when "Priority" is not active.

A "Priority" function activated before a bus voltage failure is always deactivated after a bus voltage recovery. The effect of the "Priority" function depends on the actuator channel connected (lighting, shutter/blind, heating).

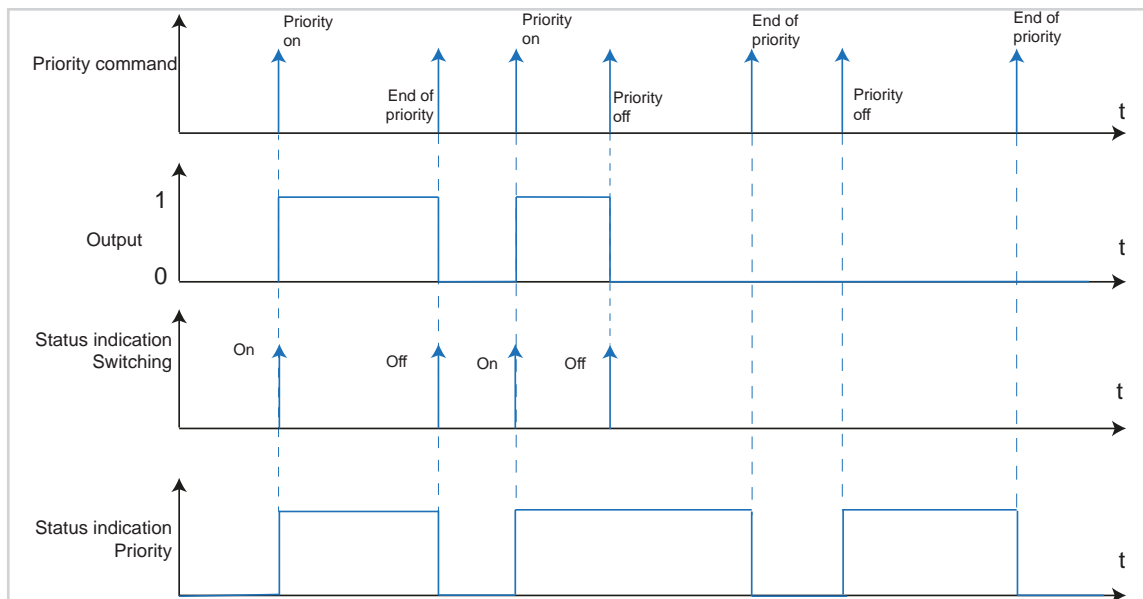

Figure 32: Signal-time diagram for Priority

Example: Locking motion detector

The **Locking motion detector** function is an application which prevents the motion detector from switching the lighting on/off constantly during an event, for example. As a result, the motion detector operation is disabled from a central point. The motion detector function is also enabled from a central point.

5.2.6 Scene function

The **Scene** function can be used as a scene extension and can be used to call up or save configured light scenes that are stored in other KNX devices. The device can call up and save a maximum of 8 scenes. Through a short key-press, the device transmits a value between 0 and 7 (where value 0 corresponds to scene 1 and value 7 corresponds to scene 8) to the bus. The scene is called up when the button is released.



Inputs			Outputs	
	80660100 - 1 -5 <i>House</i>			TXA610 - 1 -1 <i>House - lighting</i>

Figure 33: Linking **Scene** function

After selecting the Scene function, an additional menu field opens to determine the scene number. A scene between 1 - 8 can be entered here (Figure 34).

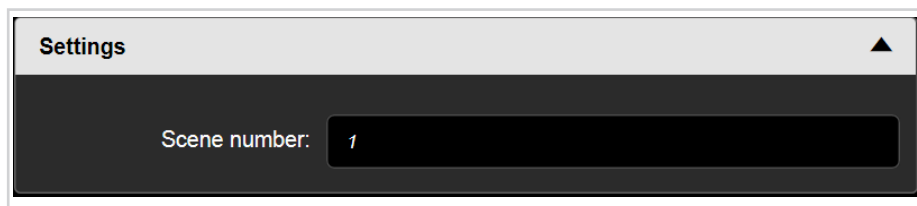

Figure 34: Entering the scene number

The related scene parameter values can be changed with the corresponding operating sections and stored with a long button press.

Example: Scene TV

In the Scene TV example, the typical scene values are changed and then the scene is saved again.

- Switch on scene using a short press of the button (Figure 35, A).
Scene is activated e.g., lighting dimmed to 30%, blind closed to 85%.

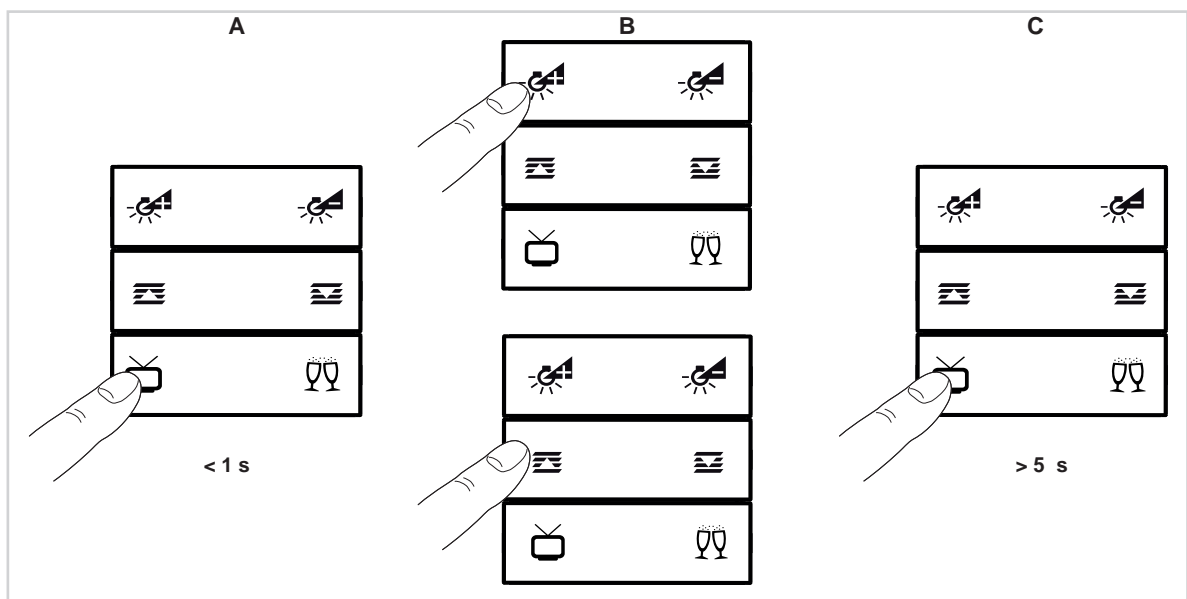



Figure 35: Scene call-up



Set new scene parameters on the push-button (Figure 35, B).

- Change lighting intensity, dim brighter or darker.
- Change blind position

- Hold the button for Scene TV  for longer than 5 s(Figure 35, C).
New scene parameters have been saved. Pressing the  button again activates the new scene settings.





































































 The Save scene by a long key-press function is switched on by default.

5.2.7 Automatic control deactivation toggle

The precise description of the **Deactivate automatic control toggle**  function can be found in chapter „5.4.11 Automatic control deactivation toggle “.

5.2.8 Overview of all possible linking combinations

The following overview shows all linking combination possibilities for the **Lighting** function. It is worth noting that inputs can also be linked with inputs (depending on the function selection).

		Linking		
Input 			Output 	
	80660100 - 1 -4 House			Display lighting
				ON/OFF output
				Dimming output
				Logic function
				Fan-Coil output
	80660100 - 1 -4 House			Display lighting
				ON/OFF output
				Dimming output
				Logic function
				Fan-Coil output
	80660100 - 1 -4 House			Display lighting
				ON/OFF output
				Dimming output
				Logic function
				Fan-Coil output
	80660100 - 1 -4 House			Display lighting
				ON/OFF output
				Dimming output
				Logic function
				Fan-Coil output
	80660100 - 1 -4 House			ON/OFF output
				Dimming output
				Fan-Coil output
	80660100 - 1 -4 House			ON/OFF output
				Dimming output
	80660100 - 1 -4 House			ON/OFF output
				Dimming output
	80660100 - 1 -4 House			ON/OFF output
				Dimming output









Linking				
Input 			Output 	
	80660100 - 1 -4 House			ON/OFF output
				Dimming output
				Motion detector (PIR)

Figure 36: Combination possibilities **Lighting** input – output

5.3 Dimming functions

The lighting can be switched on/off (short press of button) and dimmed brighter/darker (long press of button) with the **Dimming** function.

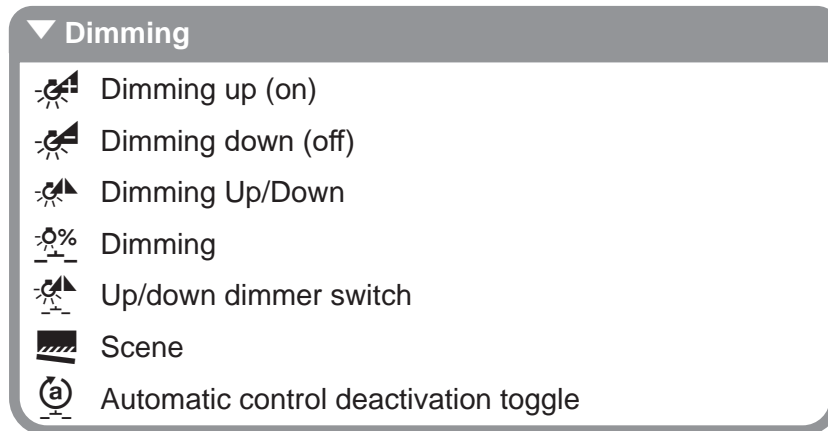

Figure 37: Functional overview **Dimming**

i All functions from the **Lighting** function group can be linked with a dimming output. Only the relevant **switching commands** is executed.

5.3.1 Functions Dimming Up (ON) / Down (Off)

With the Dimming up (on)/down (off) functions, lighting circuits/lights are switched on/off with a short press of the button and dimmed up or down with a long press of the button. This means that two buttons are needed dimming. One button for Dimming up (on) and the second button for Dimming down (off). (Figure 38).

Inputs			Outputs	
	80660100 - 1 -4 <i>House</i>			TXA661A - 1 -1 <i>House - lighting</i>
	80660100 - 1 -5 <i>House</i>			

Figure 38: Linking **Dimming up (on)/down (off)** function

5.3.2 Functions Dimming Up/Down

With this function, the lighting can be switched on/off with a short press of the button and dimmed up/down with a long press of the same button (toggle).

Inputs			Outputs	
	80660100 - 1 -4 <i>House</i>			TXA661A - 1 -1 <i>House - lighting</i>

Figure 39: Linking **Dimming up/down** function

5.3.3 Function Dimming

When the **Dimming – dimming value** function is selected, the lighting is switched on at a fixed dimming value set previously. The dimming value is entered in an additional menu field (Figure 41) as a whole number. The range for the dimming value is between 0 % and 100 %. The **Dimming – dimming value** function assigns a specific brightness value to the lamp via the connected actuator.



Inputs			Outputs	
	80660100 - 1 -4 <i>House</i>			TXA661A - 1 -1 <i>House - lighting</i>

Figure 40: Linking **Dimming – dimming value** function

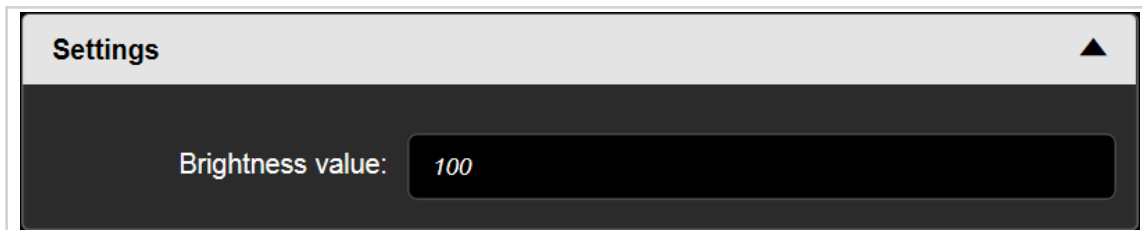

Figure 41: Set dimming value

5.3.4 Up/down dimmer switch

The lighting which is connected to a dimmer can be switched on/off and dimmed via the three button functions (- / + / ●) with the "Dimmer switch" function (Figure 42).

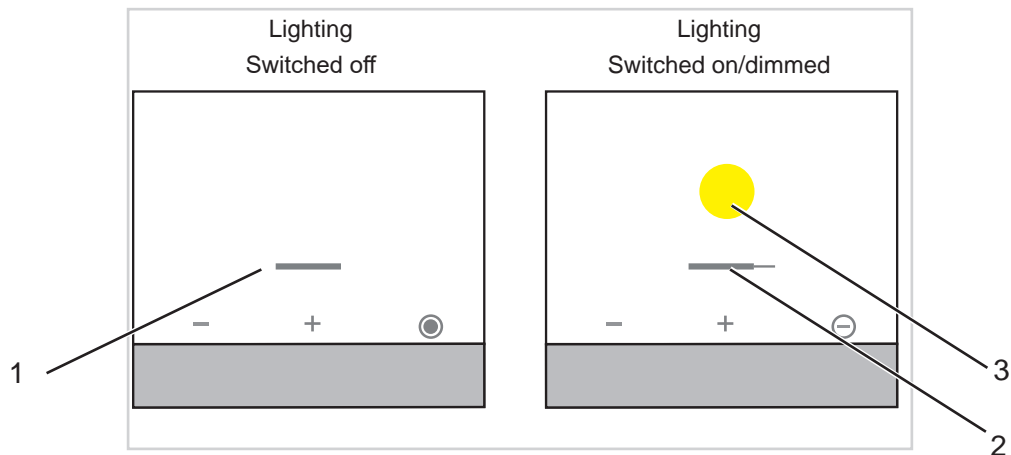

Figure 42: Display page **Dimmer switch** function

- - button:
The lighting can be switched on/off or dimmed down by pressing on the - button.
- + button:
The lighting can be switched on/off or dimmed up by pressing on the + button.
- ● / ⊖ button:
Pressing the ● button turns the lighting on and pressing the ⊖ button turns it off (toggle operation).

Pressing the touch control surface below the symbols (- / + / ● / ⊖) triggers the respective function (see also the operating instructions of the product). There is a difference between long and short button presses.

- Press - button.
Short button press: the lighting is switched off.
Long button press: the lighting is dimmed down.
- Press + button.
Short button press: the lighting is switched on.
Long button press: the lighting is dimmed up.
- ⓘ A second short button press on the +/- button triggers an inverting switching command of the dimmer output.
- Press ● / ⊖ button.
Short button press: lighting is switched on or off, depending on the status (toggle operation).

ⓘ A long button press on the ● / ⊖ does not trigger a command.

Three symbols appear on the display as status notifications (Figure 42, 1–2–3).

— : lighting switched off, dimming value 0 %

— / ● : lighting switched on; dimming value, for example, 66 %

The symbols (Figure 42, 2–3) are only displayed in combination.





Inputs			Outputs	
	80660100 - 1 -4 <i>House</i>			TXA661A - 1 -1 <i>House - lighting</i>

Figure 43: **Dimmer switch** linking function

ⓘ This function can also be linked with a switch output, but in that case, only the switch commands will be executed (short button press).

5.3.5 Scene function

The precise description of the **Scene** function can be found in Chapter „5.2.6 Scene function “.

5.3.6 Automatic control deactivation toggle

The precise description of the **Deactivate automatic control toggle** function is described in chapter „5.4.11 Automatic control deactivation toggle “.

5.3.7 Overview of all possible linking combinations

The following overview shows all linking combination possibilities for the **Dimming** function.



























Linking				
Input 			Output 	
	80660100 - 1 -4 House			ON/OFF output
				Dimming output
	80660100 - 1 -4 House			ON/OFF output
				Dimming output
	80660100 - 1 -4 House			ON/OFF output
				Dimming output
	80660100 - 1 -4 House			ON/OFF output
				Dimming output
	80660100 - 1 -4 House			ON/OFF output
				Dimming output

Figure 44: Combination possibilities **Dimming** input – output

5.4 Roller shutter function

The **Roller shutter** function for the buttons/inputs is configured in the following parameter windows.

This function is used for activating roller shutters, blinds, awnings and other hangings. With the Roller shutter and Blind functions, a distinction is made between a long and short button press.

- Short button press: the device transmits a slat step or stop command to the bus.
- Long button press: the device sends a move command (up/down) to the bus.

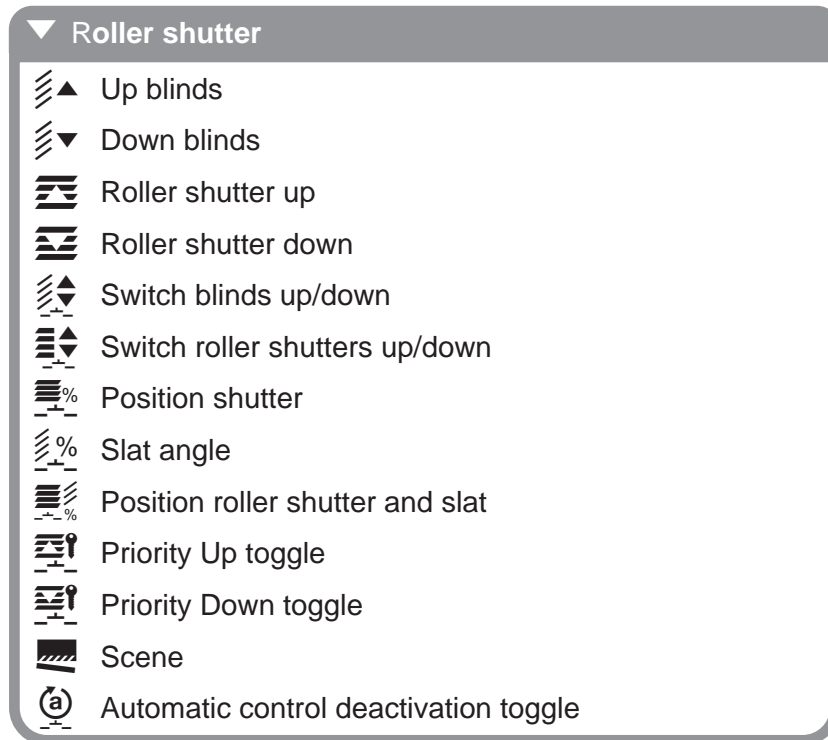

Figure 45: Functional overview **Roller shutter**

5.4.1 Basis roller shutter/blind control

In the case of roller shutter/blind drives with limit switches, the roller shutter/blind can be brought into the correct position by specifying a percentage value. The following settings are to be respected:

For blind drives, a distinction is also made between slats arranged horizontally and vertically.

Slat adjustment for slats arranged horizontally

The top final position of the roller shutter/blinds is set using the value 0 % and returned as a status value.

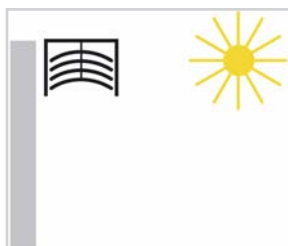

Function position in %

- Sun protection completely open
- Top final position reached: 0 %

Figure 46: Blind position top final position 0 %

The bottom final position of the roller shutter/blinds is set using the value 100 % and returned as a status value.

If a blind drive is moved from the top final position into the lower final position, then the slats will initially tilt into a nearly vertical position and the blind will move with closed slats until it reaches the bottom final position.

If a blind is in the bottom final position and the slats are fully closed, then this slat position is identified as vertical and 100 %. However, the fully closed slats cannot be exactly vertical ($\alpha = 180^\circ$); instead, they are at a slight angle from the vertical.

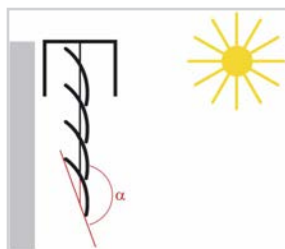

- Function position in %
- Sun protection completely closed
 - Top final position reached: 100 %

Figure 47: Blind position bottom final position 100 %

If the blind is set into motion from the vertical position (bottom end position, 100 % fully closed), the slats move into the horizontal position ($\alpha = 90^\circ$). With the Slat adjustment function, it is possible to determine the number of steps so that the slats can be adjusted almost infinitely.

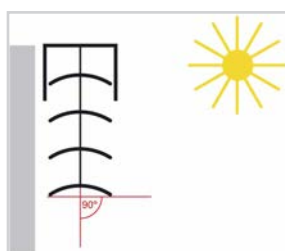

- Slat angle in %
- Slat position horizontal ($\alpha = 90^\circ$)

Figure 48: Adjust slat angle

With blinds, the position of the slats can be adjusted beyond the horizontal position until they have reached the maximum point to which they can be adjusted and the blind starts moving towards the top final position. The slat angle can therefore adopt a value between 0 and 90° annehmen.

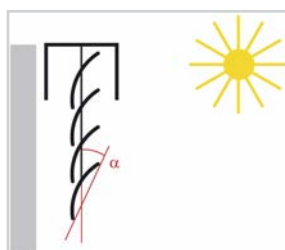

- Slat angle in %
- Slat position at the start of the movement towards the top final position

Figure 49: Slat angle at the start of the movement towards the top final position

Slat adjustment for slats arranged vertically

When there is shade or screen with slats arranged vertically, the shade behaves like slats arranged horizontally. As a result, when the slats are fully open, the value 0 % is transmitted and returned as a status value. The slats therefore form an angle of $\alpha = 90^\circ$ the fully open shade to the fully closed shade.

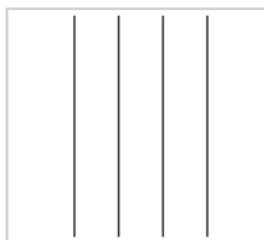

Slat angle in %

- Fully open slats arranged vertically $\alpha = 90^\circ$

Figure 50: Slat angle for slats arranged vertically $\alpha = 90^\circ$

Fully closed slats are operated with a value of 100 %, which is also returned as a status. The angle which the slats form with the direction of travel is approximately 0° .

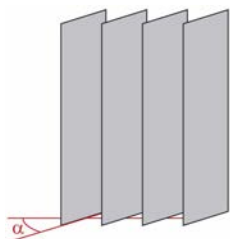

Slat angle in %

- Fully closed slats arranged vertically $\alpha \approx 0^\circ$

Figure 51: Slat angle for slats arranged vertically $\alpha \approx 0^\circ$

If the shade is open, the slats turn into a position at an angle a little less than 180° .

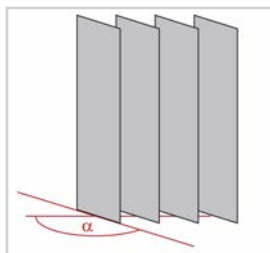

Slat angle in %

- Slats arranged vertically when opening $\alpha \approx 180^\circ$

Figure 52: Slat angle when opening $\alpha \approx 180^\circ$

5.4.2 Functions blinds up / blinds down

If the button/input is assigned the **Blind up/down** function, the blinds can then be moved up and down. A motion command is transmitted to the actuator if the button is pressed for a long time and a stop command is transmitted if the button is pressed for a short time.





Inputs			Outputs	
	80660100 - 1 -4 <i>House</i>			TXA610 - 1 -1 <i>House - roller shutter</i>
	80660100 - 1 -5 <i>House</i>			

Figure 53: Linking **Blind up/down** function

 Further information, e.g. operating mode, running time to top/bottom final position, can be found in the application description for the respective roller shutter/blind output.

5.4.3 Functions roller shutter up / roller shutter down

If the button/input is assigned the **Roller shutter up/down** function, the roller shutters can therefore be moved up and down. A motion command is transmitted to the output if the button is pressed for a long time and a stop command is transmitted if the button is pressed for a short time.





Inputs			Outputs	
	80660100 - 1 -4 <i>House</i>			TXA610 - 1 -1 <i>House - roller shutter</i>
	80660100 - 1 -5 <i>House</i>			

Figure 54: Linking **Roller shutter up/down** function

 Further information, e.g. operating mode, running time to top/bottom final position, can be found in the settings for the respective roller shutter/blind output.

5.4.4 Switch blinds up/down

If the button/input is assigned the **Blind up/down** function, the blinds can then be moved up and down. A motion command is transmitted to the actuator if the button is pressed for a long time and a stop command is transmitted if the button is pressed for a short time.



Inputs			Outputs	
	80660100 - 1 -4 <i>House</i>			TXA610 - 1 -1 <i>House - roller shutter</i>

Figure 55: Linking **Blind up/down** function

5.4.5 Switch roller shutters up/down

If the button/input is assigned the **Switch roller shutter up/down** function, the roller shutters can therefore be moved up and down. A motion command is transmitted to the output if the button is pressed for a long time and a stop command is transmitted if the button is pressed for a short time.



Inputs			Outputs	
	80660100 - 1 -4 <i>House</i>			TXA610 - 1 -1 <i>House - roller shutter</i>

Figure 56: Linking **Switch roller shutter up/down** function

The only difference between the functions blind up/blind down and switching blind up/down, and roller shutter up/roller shutter down and switching roller shutter up/down is how they appear on the display. The operating function is identical for both variants (Figure 57).

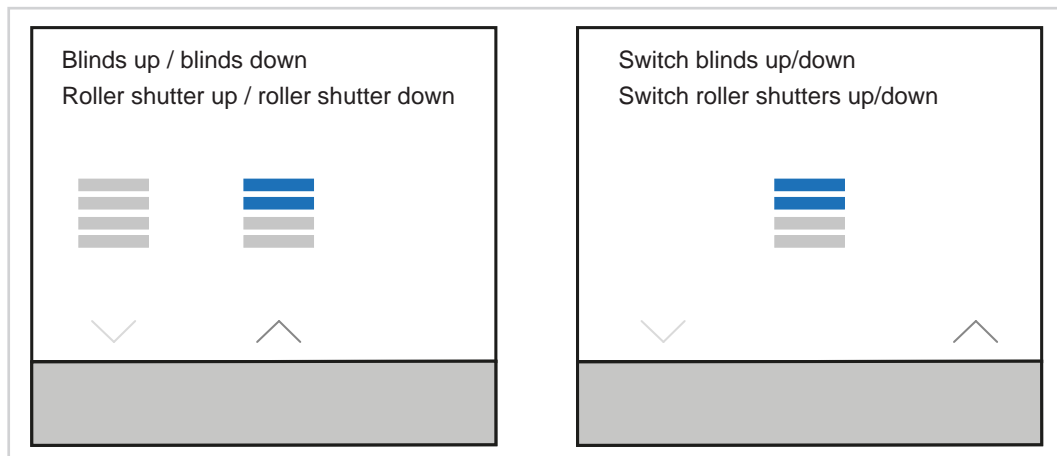

Figure 57: Display views

5.4.6 Function roller shutter position

A short press on the button configured with the **Roller shutter position** function switches the roller shutter output on until it reaches the set position between 0 and 100 % (Figure 59).

- 0 %: top final position reached: 0 %, roller shutter/blind is open
- 100 %: bottom final position reached: 0 %, roller shutter/blind is closed



Inputs			Outputs	
	80660100 - 1 -5 <i>House</i>			TXA610 - 1 -1 <i>House - roller shutter</i>

Figure 58: Linking **Roller shutter position** function

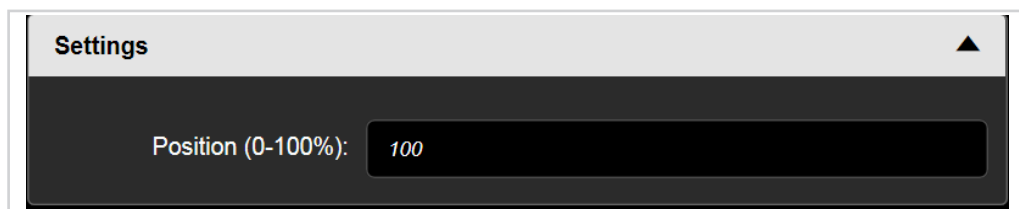

Figure 59: Entering the roller shutter position between 0 and 100 %

5.4.7 Function slat angle

A short press on the button configured with the **Slat angle** function switches on the blind output until it reaches the set slat angle between 0 and 100 % (Figure 61).



Inputs			Outputs	
	80660100 - 1 -5 <i>House</i>			TXA610 - 1 -1 <i>House - roller shutter</i>

Figure 60: Linking **Slat angle** function

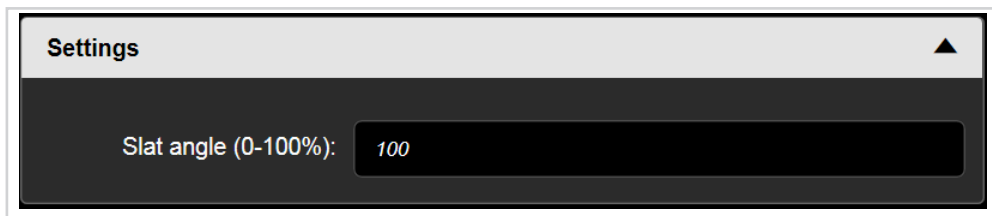

Figure 61: Entering the slat angle 0 - 100 %

5.4.8 Functions Roller shutter and slat position

A short press on the button configured with the **Roller shutter and slat position** function switches the roller shutter/blind output on until it reaches the set slat angle between 0 and 100 % and the position between 0 and 100 % (Figure 63).



Inputs			Outputs	
	80660100 - 1 -5 <i>House</i>			TXA610 - 1 -1 <i>House - roller shutter</i>

Figure 62: Linking **Roller shutter and slat position** function

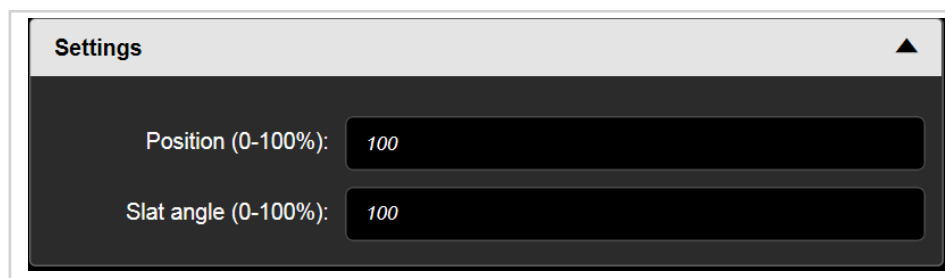

Figure 63: Entering the position/slat angle 0 - 100 %

5.4.9 Functions Priority up toggle / down toggle

The **Priority** function allows a roller shutter/blind output to be forced to a switch position by a telegram regardless of a switching command (higher priority). As a result, the Priority can be switched on/off with the same button (toggle).

Inputs			Outputs	
	80660100 - 1 -5 <i>House</i>			TXA610 - 1 -1 <i>House - roller shutter</i>

Figure 64: Linking **Priority up toggle** function

Inputs			Outputs	
	80660100 - 1 -4 <i>House</i>			TXA610 - 1 -1 <i>House - roller shutter</i>

Figure 65: Linking **Priority down toggle** function

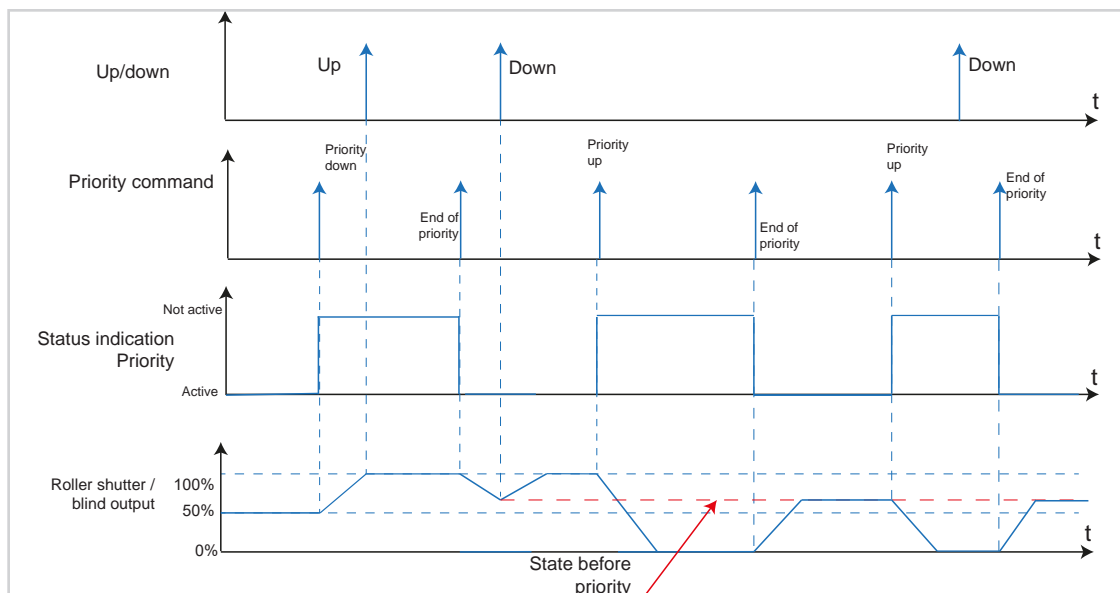

Figure 66: Signal-time diagram for **Priority roller shutter/blind**

The value of the telegram is defined according to the following syntax:

When "Priority" is active, incoming switch telegrams are still evaluated internally; when "Priority" is no longer active, the current switch condition is set.

A "Priority" function activated before a bus voltage failure is always deactivated after a bus voltage recovery. The effect of the "Priority" function depends on the actuator channel connected (lighting, shutter/blind, heating).

Example: "Window cleaner" function

The "Window cleaner" function is an application that prevents a manual operation of the blind/roller shutter from being executed during the window cleaning. As a result, the blind/roller shutter operation is disabled from a central point. Blinds that have already been lowered are moved to the upper stop position. The manual blind/roller shutter function is also enabled from a central point.

5.4.10 Scene function

The precise description of the **Scene** function can be found in Chapter „5.2.6 Scene function “.

5.4.11 Automatic control deactivation toggle

With this function, it is possible to deactivate and activate the automatic functions in the actuators which are already running (Toggle mode).

Inputs			Outputs	
	80660100 - 1 -5 <i>House</i>			TXA610 - 1 -1 <i>House - lighting</i>

Figure 67: Linking **Automatic control deactivation toggle** function

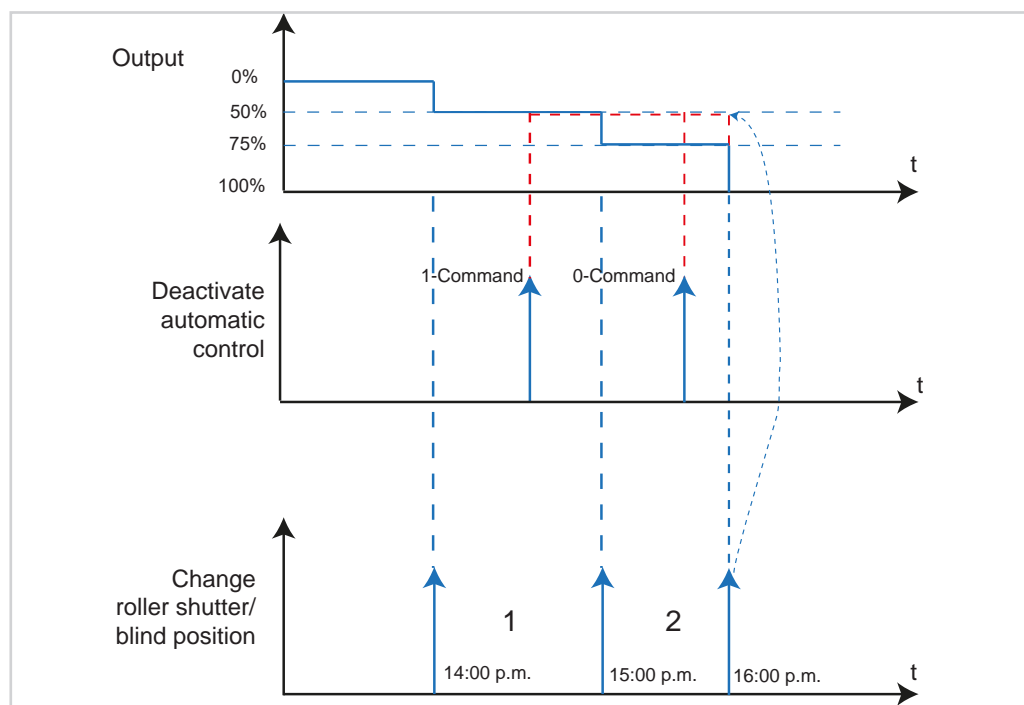

Figure 68: Signal-time diagram for Automatic control deactivation

Example: Shading control using position of sun

The shading control should move the blind up and down depending on the position of the sun. In the example (Figure 68), the blind is moved to different positions at 2 p.m., 3 p.m. and 4 p.m. Between 2 p.m. and 3 p.m. (1), the button with the **Deactivate automatic control** function is pressed. As a result, the blind position for 3 p.m. is not carried out, but remains in the 2 p.m. position. Between 3 p.m. and 4 p.m. (2), the button with the **Deactivate automatic control** function is pressed again (toggle operation). The Deactivate automatic control function is now switched off and the blind moves into the corresponding position at 4 p.m.

5.4.12 Overview of all possible linking combinations

The following overview shows all linking combination possibilities for the **Roller shutter** function.















































Linking				
Input 			Output 	
	80660100 - 1 -4 House			Output roller shutter/blind
	80660100 - 1 -4 House			Output roller shutter/blind
	80660100 - 1 -4 House			Output roller shutter/blind
	80660100 - 1 -4 House			Output roller shutter/blind
	80660100 - 1 -4 House			Output roller shutter/blind
	80660100 - 1 -4 House			Output roller shutter/blind
	80660100 - 1 -4 House			Output roller shutter/blind
	80660100 - 1 -4 House			Output roller shutter/blind
	80660100 - 1 -4 House			Output roller shutter/blind
	80660100 - 1 -4 House			Output roller shutter/blind
	80660100 - 1 -4 House			Output roller shutter/blind
	80660100 - 1 -4 House			Output roller shutter/blind
	80660100 - 1 -4 House			Output roller shutter/blind
	80660100 - 1 -4 House			Output roller shutter/blind
	80660100 - 1 -4 House			Output blind

Figure 69: Combination possibilities **Roller shutter** input – output

5.5 Heating/cooling functions

The **Heating/cooling** function allows an external KNX room thermostat to be activated using the push-button operation buttons.

This allows the user to change/adjust basic controller functions (such as operating mode change-over, setpoint selection, heating/cooling change-over) from different places in the room.

i The room thermostat extension unit, however, is not involved in actually controlling the temperature.

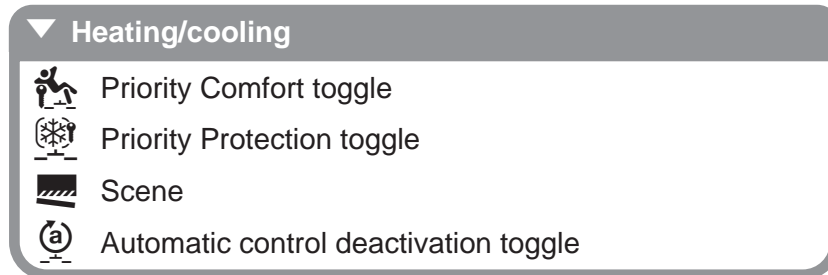





Figure 70: Functional overview **Heating/cooling**

With the Comfort, Eco, Standby and Protection mode functions, the corresponding operating modes can be switched on in the associated thermostats or changed and transmitted to the bus by pressing a button.

Example:

- Comfort 

The **Comfort** operating mode sets the room temperature to a temperature value predefined in the thermostat (e.g. comfort temperature 21°C) for comfort (presence).
- Standby 

The **Standby** operating mode reduces the room temperature after leaving the room (brief absence) to a value predefined in the thermostat (19°C, for example).
- Eco 

The **Eco** operating mode turns down the room temperature during holiday time (during long absence) to a value of 17°C defined in the thermostat.
- Frost protection 

The **Protection** operating mode reduces the heating circuit temperature to a minimum temperature of 7°C defined in the controller to protect against frost damage over night or during periods of extended absence.

i With underfloor heating, the change-over from "Comfort" to Standby is only noticeable after a certain period of time due to the sluggishness of the underfloor heating system.

The respective symbol for the **Comfort**, **Standby**, **Eco** and **Protection** modes is displayed in colour on the base side of the device.

Colour of status LED	Operating mode
orange	Mode Comfort
green	Mode Standby
blue	Eco mode
red	Protection mode

Table 5: Operating mode - Colour of status LED

5.5.1 Function Priority comfort toggle

With the **Priority comfort toggle** function, the operating mode which is currently running is interrupted and the thermostat is set to **Comfort** mode.

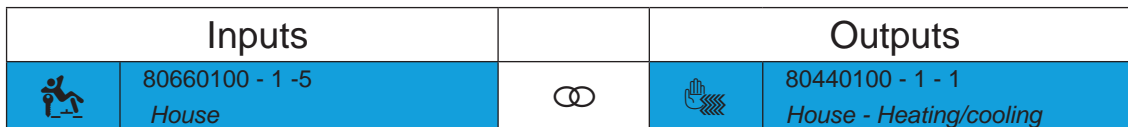

Figure 71: Linking **Priority comfort toggle** function

Forced mode is switched on with a 1-command and off with a 0-command.

Control	Output behaviour
0	Switch off forced mode
1	Switch on forced mode

Table 6: Overwrite nominal temperature value

Example: Extending the Comfort operating mode

The **Priority comfort toggle** function can be used to prevent the previously set operating mode change-over and force the **Comfort** operating mode during events which are going to end later, for example. Once the event has finished, the forced operating mode is switched off and the actual operating mode is switched on. This is done with the same button (Toggle mode).

5.5.2 Function Priority protection toggle

With the **Priority protection toggle** function, the operating mode which is currently running is interrupted and the thermostat is set to **Protection** mode.

Forced mode is switched on with a 1-command and off with a 0-command.

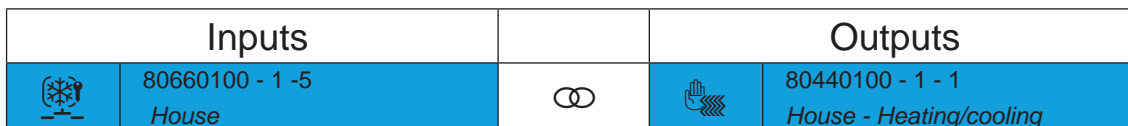



Figure 72: Linking **Priority protection toggle** function

Example: Extending the Protection operating mode

The **Priority protection toggle** function can be used to prevent the previously set operating mode change-over and force the **Protection** operating mode during periods of extended absence. Once a person has returned, the forced operating mode is switched off and the actual operating mode is switched on. This is done with the same button (Toggle mode).

5.5.3 Scene function

The precise description of the **Scene** function can be found in Chapter „5.2.6 Scene function “.

5.5.4 Automatic control deactivation toggle

The precise description of the **Deactivate automatic control toggle** function is described in chapter „5.4.11 Automatic control deactivation toggle “.

5.5.5 Overview of all possible linking combinations

The following overview shows all linking combination possibilities for the **Heating/cooling** function. It is worth noting that inputs can also be linked with inputs (depending on the function selection).

Linking			
Input			Input
 80440100 - 1 -1 House 80660100 - 1 -1 House			Mode Comfort
			Eco mode
			Mode Standby
			Protection mode
			Heating mode auto
			Heating mode switching
			Switching Comfort/Eco mode
			Switching Comfort/Standby mode
			Mode Protection Automatism
			$\pm \chi$ Setpoint Offset
			Priority Comfort mode
			Priority Protection mode
			Priority Comfort toggle
			Priority Protection toggle
			Window status
			Heating/cooling switching
			Heating/cooling toggle
			Mode Comfort Automatism
			Eco mode auto
			Mode Standby Automatism
Mode Protection Automatism			
Heating mode auto toggle			

Figure 73: Linking input – input **Heating/cooling**

Linking			
Input			Output
	80660100 - 1 -2 House		TXE530 - 1 -1 House - roller shutter

Figure 74: Linking input – output **Heating/cooling**

6. Appendix

6.1 Technical data

KNX medium	TP 1
Configuration mode	E-Controller
Rated voltage KNX	21 ... 32 V SELV
Auxiliary voltage	24 V +/- 6 % SELV
Current consumption KNX	max. 10 mA
Current consumption 24 V auxiliary voltage	25 mA
Max. short-circuit current	< 740 mA
Connection mode KNX	KNX connecting terminal
Power reserve	battery ≈ 4 h
Operating altitude	< 2000 m
Operating temperature	-5 to +45 °C
Storage/transport temperature	-25 ... +70 °C
Humidity	max. 60 % < 45 °C, 90% at 45°C, no condensation
Screen diagonal	1.93"
Screen size	38.28 x 30.26 mm
Cable length ext. temperature sensor	max. 10 m
Degree of protection	IP21
Impact protection	IK04
Protection class	III
Test mark	KNX, CE
Electric strength	4 kV
Overvoltage category	III
Degree of contamination	2
Control function	class A
Mode of action	type 2
Ball pressure test	at 75 °C
Standards	EN 60730-2-9, EN 50491-3 EN 50491-5-2

Specification for separate auxiliary voltage supply

Output voltage	24 V +/- 6 % SELV
Output current	max. 1 A
Dielectric strength	min. 4 kV
Standards	EN 61558

6.2 Accessories

Cover for KNX thermostat, KNX room controller	8096 01 xx
Remote sensor	EK090

6.3 Warranty

We reserve the right to realise technical and formal changes to the product in the interest of technical progress.

Our products are under guarantee within the scope of the statutory provisions.

If you have a warranty claim, please contact the point of sale.

7. Table of Figures

Figure 1: Device overview	6
Figure 2: Display elements	7
Figure 3: Push-button operation operating concept	8
Figure 4: Slider operation operating concept	8
Figure 6: Input/output signals Lighting function	11
Figure 7: Input/output signals Dimming function	12
Figure 8: Input/output signals Roller shutter function	13
Figure 9: Input/output signals Heating/cooling function.....	14
Figure 10: Device information.....	16
Figure 11: Display settings	16
Figure 12: Overview inputs/outputs	18
Figure 13: Background/display lighting.....	20
Figure 14: Switch off background/display lighting	20
Figure 15: Heating/cooling settings	21
Figure 16: Heating/cooling parameter	21
Figure 17: Linking input – input Heating/cooling	22
Figure 18: 2-point control.....	24
Figure 19: Switching PI-control (PWM)	25
Figure 20: Linking input – input Internal temperature sensor function	26
Figure 21: Linking input – output Internal temperature sensor function	26
Figure 22: Linking input – input External temperature sensor function	26
Figure 23: Function selection of the touch control surface	27
Figure 24: Functional overview lighting	29
Figure 25: Linking function On - Off	29
Figure 26: Linking Function switching	30
Figure 27: Linking Toggle switch function.....	30
Figure 28: Linking Timer function.....	30
Figure 29: Signal-time diagram for timer	30
Figure 30: Linking Priority on toggle function.....	31
Figure 31: Linking Priority off toggle function	31
Figure 32: Signal-time diagram for Priority	31
Figure 33: Linking Scene function.....	32
Figure 34: Entering the scene number	32
Figure 35: Scene call-up.....	32
Figure 36: Combination possibilities Lighting input – output.....	35
Figure 37: Functional overview Dimming	36
Figure 38: Linking Dimming up (on)/down (off) function	36
Figure 39: Linking Dimming up/down function	36
Figure 40: Linking Dimming – dimming value function.....	37
Figure 41: Set dimming value.....	37
Figure 42: Display page Dimmer switch function.....	37
Figure 43: Dimmer switch linking function.....	38
Figure 44: Combination possibilities Dimming input – output.....	39
Figure 45: Functional overview Roller shutter	40

Figure 46: Blind position top final position 0 %.....	40
Figure 47: Blind position bottom final position 100 %.....	41
Figure 48: Adjust slat angle	41
Figure 49: Slat angle at the start of the movement towards the top final position.....	41
Figure 50: Slat angle for slats arranged vertically $\alpha = 90^\circ$	42
Figure 51: Slat angle for slats arranged vertically $\alpha \approx 0^\circ$	42
Figure 52: Slat angle when opening $\alpha \approx 180^\circ$	42
Figure 53: Linking Blind up/down function.....	43
Figure 54: Linking Roller shutter up/down function	43
Figure 55: Linking Blind up/down function.....	43
Figure 56: Linking Switch roller shutter up/down function.....	43
Figure 57: Display views.....	44
Figure 58: Linking Roller shutter position function	44
Figure 59: Entering the roller shutter position between 0 and 100 %.....	44
Figure 60: Linking Slat angle function	45
Figure 61: Entering the slat angle 0 - 100 %	45
Figure 62: Linking Roller shutter and slat position function	45
Figure 63: Entering the position/slat angle 0 - 100 %.....	45
Figure 64: Linking Priority up toggle function.....	46
Figure 65: Linking Priority down toggle function.....	46
Figure 66: Signal-time diagram for Priority roller shutter/blind	46
Figure 67: Linking Automatic control deactivation toggle function.....	47
Figure 68: Signal-time diagram for Automatic control deactivation	47
Figure 69: Combination possibilities Roller shutter input – output.....	48
Figure 70: Functional overview Heating/cooling	49
Figure 71: Linking Priority comfort toggle function.....	50
Figure 72: Linking Priority protection toggle function	50
Figure 73: Linking input – input Heating/cooling	51
Figure 74: Linking input – output Heating/cooling	51

8. List of tables

Table 1: Display setting.....	17
Table 2: Heating setpoints	23
Table 3: Cooling setpoints	23
Table 4: Function of the touch operating surface	28
Table 5: Operating mode - Colour of status LED.....	49
Table 6: Overwrite nominal temperature value	50