

EN Motorised changeover switch  
125A - 630A

6LE001123A.e

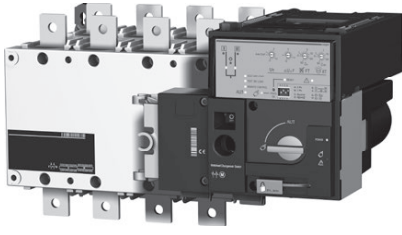

HIC4xxG



**Preliminary operations**

Check the following upon delivery and after removal of the packaging:

- Packaging and contents are in good condition.
- The product reference corresponds to the order.
- Contents should include:
  - 1 x motorised changeover switch
  - 1 x emergency handle and fixing clip
  - 1 x quick start instruction sheet.

**Accessories**

- Bridging bars and connection kits.
- Terminal shrouds.
- Terminal shield.
- Voltage sensing kit.
- Sealable cover.

This quick start is intended for personnel trained in the installation and commissioning of this product. For further details refer to the product instruction manual available on the hager website.

- This product must always be installed and commissioned by qualified and approved personnel.
- Maintenance and servicing operations should be performed by trained and authorised personnel.
- Do not handle any control or power cables connected to the product when voltage may be, or may become present on the product, directly through the mains or indirectly through external circuits.
- Always use an appropriate voltage detection device to confirm the absence of voltage.
- Ensure that no metal objects are allowed to fall in the cabinet (risk of electrical arcing).

Failure to observe good engineering practises as well as to follow these safety instructions may expose the user and others to serious injury or death.



Risk of electrocution, burns or injury to persons and/or damage to equipment. Risk of damaging the device. In case the product is dropped or damaged in any way it is recommended to replace the complete product.

**Installation and commissioning**

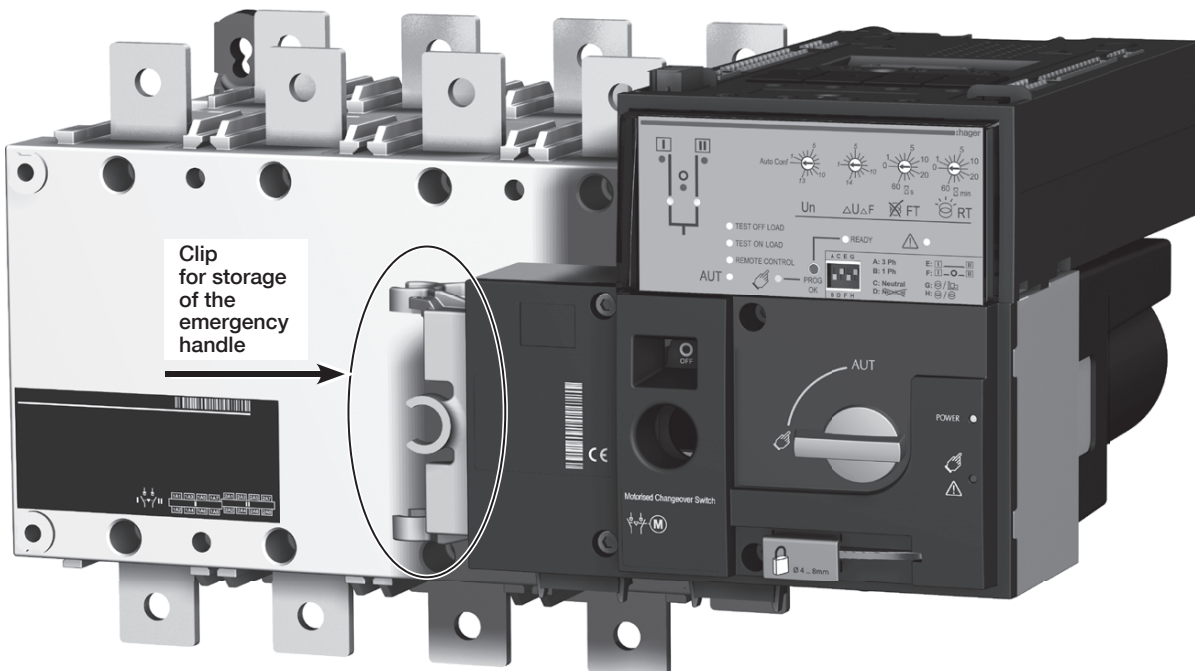
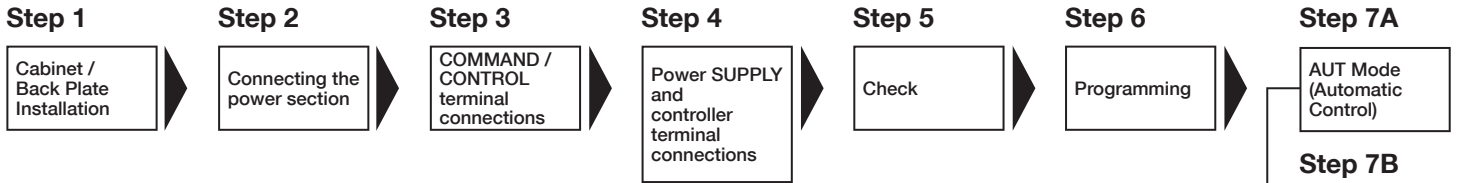

# 1. Installation

Dimensions in mm



Ensure that the product is installed on a flat rigid surface.

## Orientation

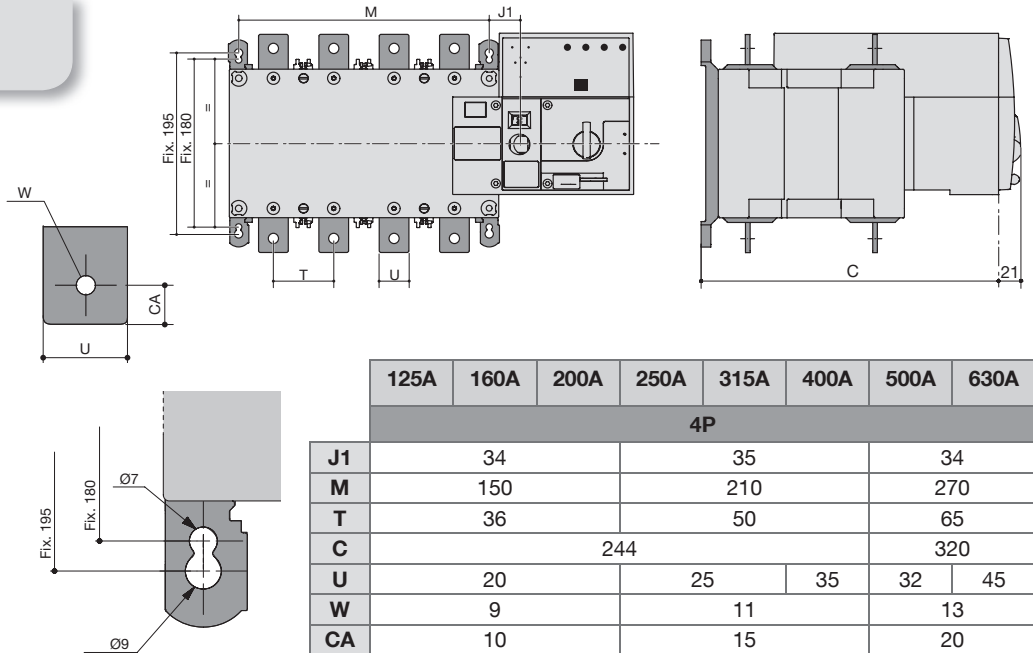
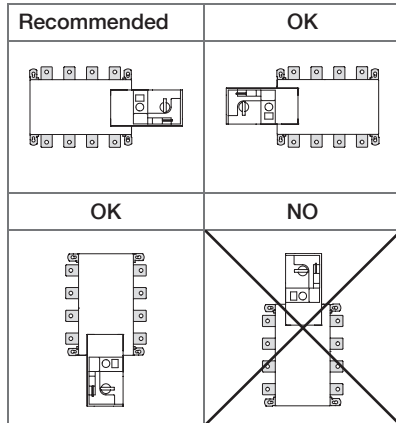

## Door cut-out for front panel

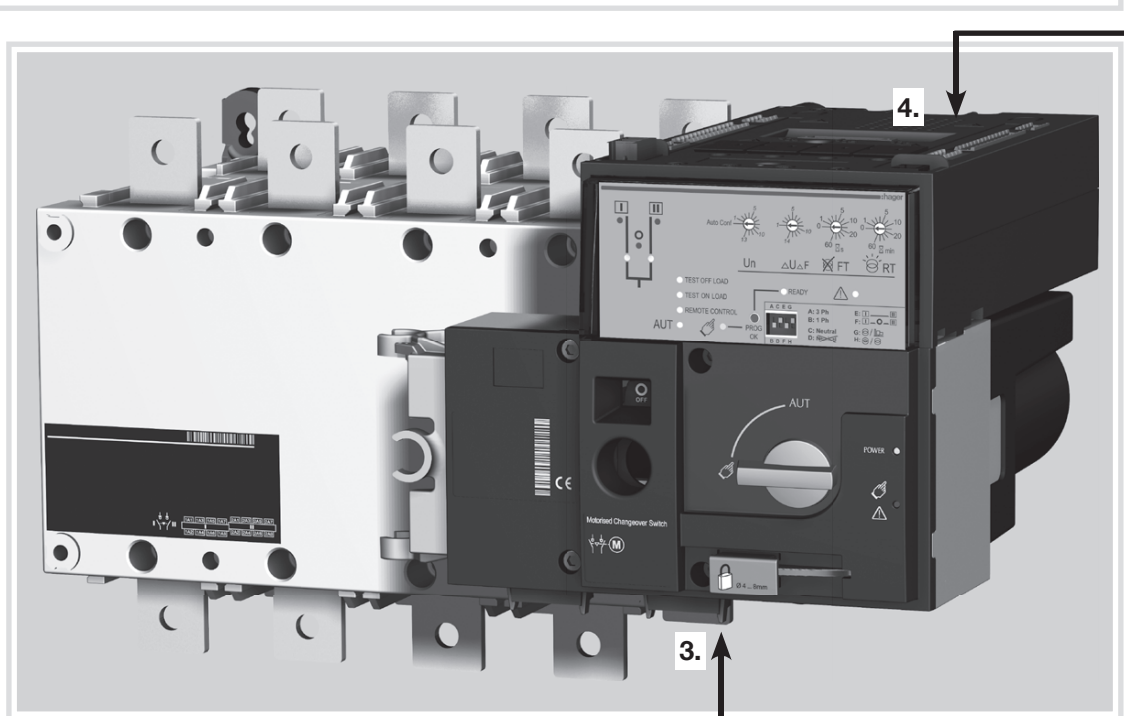
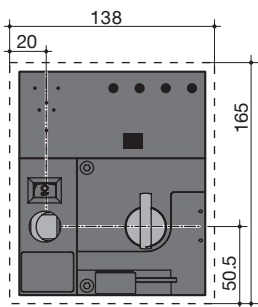

## 2. Power terminal connections

Use terminal lugs, rigid or flexible busbars.

|   | 125A | 160A | 200A | 250A | 315A | 400A  | 500A   | 630A   |  |
|---|------|------|------|------|------|-------|--------|--------|--|
| Minimum Cu cable section at lth (mm <sup>2</sup> )  | 35   | 50   | 95   | 120  | 185  | 2x95  | 2x120  |        |  |
| Minimum Cu busbar section at lth (mm <sup>2</sup> ) | -    |      |      |      |      |       | 2x30x5 | 2x40x5 |  |
| Maximum Cu cable section (mm <sup>2</sup> )         | 50   | 95   | 120  | 150  | 240  | 2x185 | 2x300  |        |  |
| Maximum Cu busbar width (mm)                        | 25   |      | 32   |      |      | 50    |        |        |  |
| Type of screw                                       | M8   |      |      | M10  |      | M12   |        |        |  |
| Recommended tightening torque (N.m)                 | 8,3  |      |      | 20   |      | 40    |        |        |  |
| Maximum tightening torque (N.m)                     | 13   |      |      | 26   |      | 45    |        |        |  |

## 3. CONTROL/COMMAND terminals

Ensure that the product is in Manual Mode.

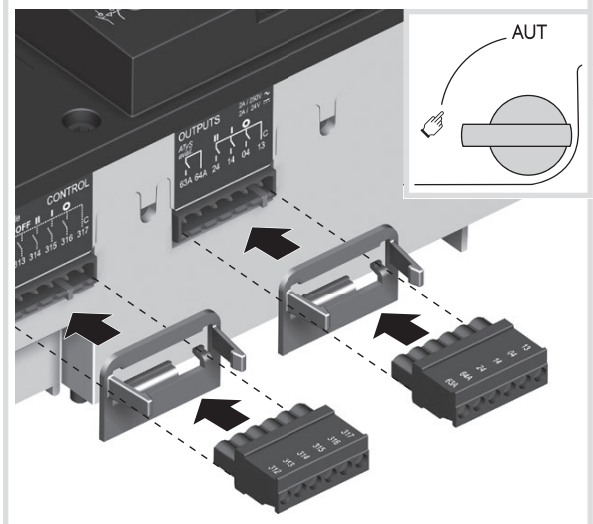

## 4. Power supply, sensing and control wiring

Use cables with 1,5 to 2,5 mm<sup>2</sup> section.

Screw M3

Tightening torque: min.: 0.5 Nm - max.: 0.6 Nm

Recommended to use the voltage sensing kit

### ATS Power Supply input II

Power Supply II - L  
Power Supply II - N  
208-277 VAC ±20%:  
50/60 Hz



### ATS Voltage Sensing input Source supply II

S II - Phase 1  
S II - Phase 2  
S II - Phase 3  
600 VAC (ph-ph) max  
S II - Neutral  
332 VAC (ph-n) max



### ATS Module Control Inputs (fixed)

**Contact**  
Genset Start/Stop (product available)  
Signal

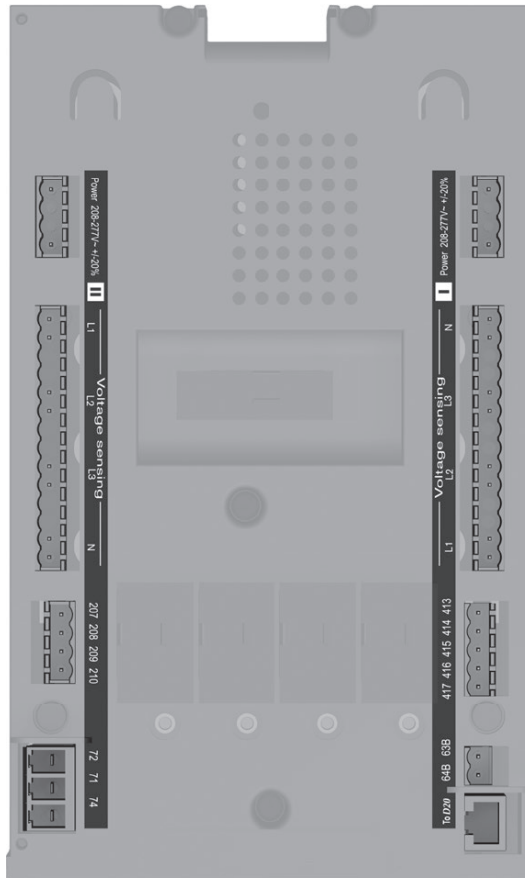

### ATS Power Supply input I

Power Supply II - L  
Power Supply II - N  
208-277 VAC ±20%:  
50/60 Hz



### ATS Voltage Sensing input Source supply II

S I - Phase 1  
S I - Phase 2  
S I - Phase 3  
600 VAC (ph-ph) max  
S I - Neutral  
332 VAC (ph-n) max



### ATS Module Control Inputs (fixed)

**ATS Module Output Contact**  
(product available)



**Remote interface**  
RJ45 - to HZI910



Example: control wiring for a 400VAC application having a 3 phase and neutral supply

1 Preferred source    2 Alternate source

- 1 Position 0 order
- 2 Position 1 order
- 3 Position 2 order
- 4 Zero position priority order
- 5 Remote Control Enable (Priority over Auto)
- 6 Product Available output (Motor)
- 7 Position II aux contact
- 8 Position I aux contact
- 9 Position 0 aux contact
- 10 O/P to HZI910 remote display
- 11 Product Available output (ATS)
- 12 I/P Inhibition of the ATS controls
- 13 I/P Manual retransfer
- 14 S2 Stability Time Bypass: 2AT
- 15 Priority to TEST ON LOAD: TON
- 16 TEST OFF LOAD Signal: TOF
- 17 TEST ON LOAD Signal: TON
- 18 Not used
- 19 Contact "Start/Stop Genset": if S1 is not available the NC contact le contact (71-72) is close
- 20 Contact "Start/Stop Genset": if S1 is not available the NO contact le contact (71-74) is open
- 21 Voltage Sensing Inputs
- 22 Power Supply Inputs

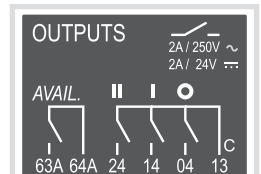
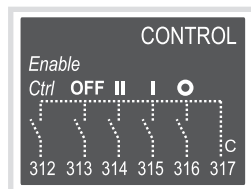
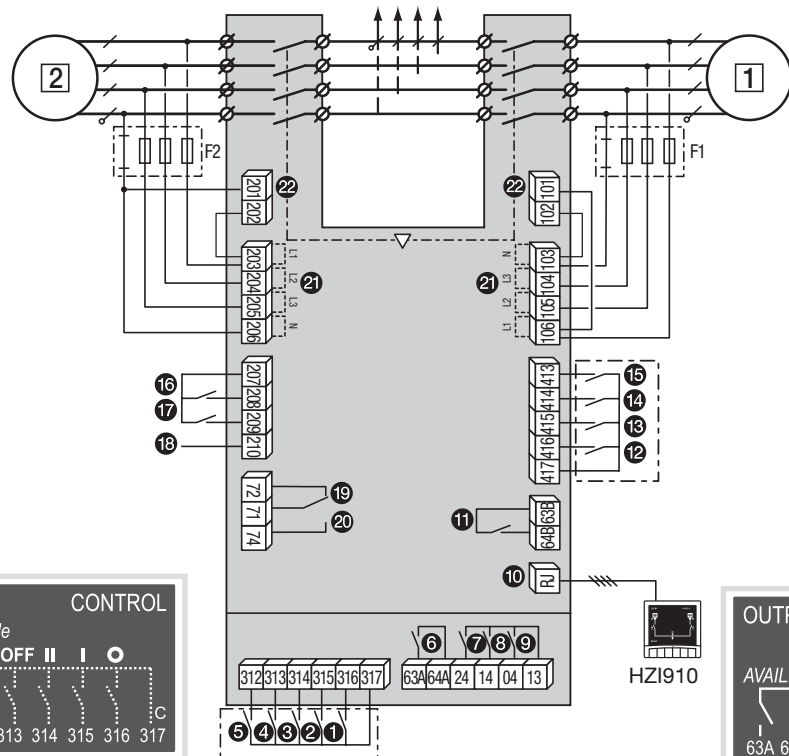

## 5. Check

In manual mode, check the wiring. If OK power up the product

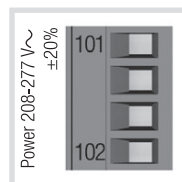
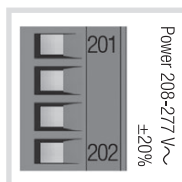
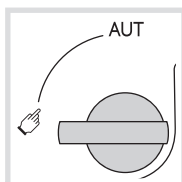

LED Green = "Power" : ON

LED Red = "Manual/Default" : ON

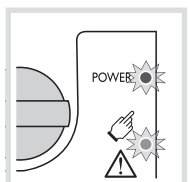

## 6. Programming the product

The product is programmed after wiring verification tests through the front of the product Controller in 5 steps:

### Note

Ensure that the product is in "Manual Mode", powered and with at least one network supply available.



As a safety measure the READY LED will flash when any of the settings shown on the controller are different to those that are saved. To return to the steady READY LED revert to the saved setting values or save the displayed value by pressing the PROG OK button briefly (This is intended as a visual alarm in case one has changed the configuration settings but has not yet saved the new values in the product). For added security the product may be equipped with a sealable cover so as to limit the access to configuration settings. Refer to the product accessory section for details.

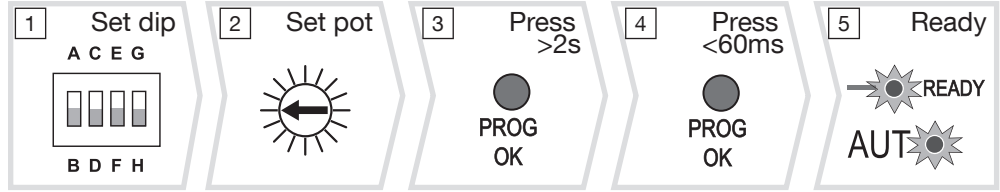
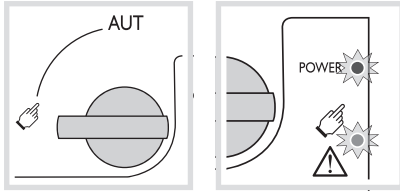

### 1 Dip switch setting options

SET the 4 Dip Switches using a small screw driver. Possible variants vary from positions "A to H" as described in the table below. For convenience, the position functions are also described on the front of the ATS controller adjacent to the dip switches

### Note

The READY LED will flash green as soon as settings are changed and until the new settings have been saved by pressing the PROG OK button momentarily (refer to Step 4).

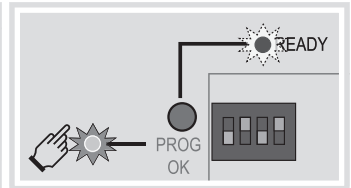
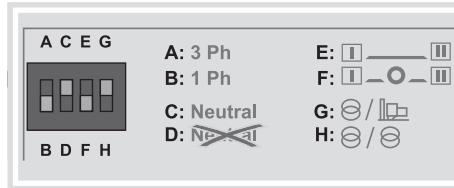
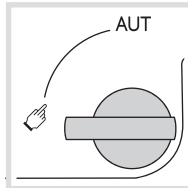

| Dip switch setting options |   |   |
|----------------------------|---|---|
| Dip switch 1<br>A/B        | A | Three Phase Network   |
|                            | B | Single Phase Network<br>(Attn: Dipswitch 2 is inactive in this position)                                    |
| Dip switch 2<br>C/D        | C | Three Phase 4 wire Network (Including Neutral)<br>(Allows to detect a loss of neutral for unbalanced loads) |
|                            | D | Three Phase 3 wire Network (Without Neutral)  |
| Dip switch 3<br>E/F        | E | Without a time delay in Zero Position (DBT = 0 sec)   |
|                            | F | Zero position time delay set to 2s (DBT = 2 sec)  |
| Dip switch 4<br>G/H        | G | Main - Generator Application  |
|                            | H | Main - Main Application   |

### 2 Potentiometer setting options

SET the 4 potentiometers using a small screw driver paying attention to the arrow indicating the position. There are a total of 14 positions for which the specific settings are described in the table below.

### Note

The READY LED will flash green as soon as settings are changed and until the new settings have been saved by pressing the PROG OK button momentarily (refer to Step 4).

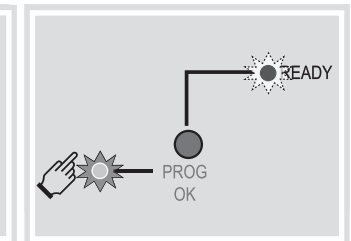
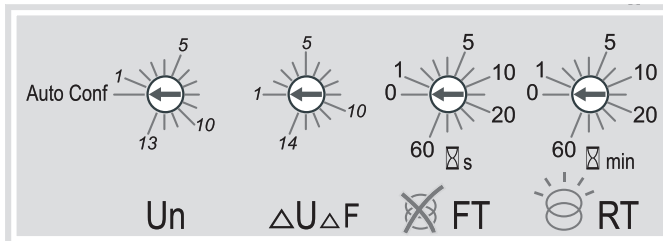

| Un    | N° PP / PN    | N°: ΔU ΔF % |
|-------|---------------|-------------|
| 50 Hz | 1: 220 / 127  | 1: 5 3      |
|       | 2: 380 / 220  | 2: 6 3      |
|       | 3: 400 / 230  | 3: 7 4      |
|       | 4: 415 / 240  | 4: 8 4      |
|       | 5: 480 / 277  | 5: 9 5      |
| 60 Hz | 6: 208 / 120  | 6: 10 5     |
|       | 7: 220 / 127  | 7: 11 6     |
|       | 8: 230 / 132  | 8: 12 6     |
|       | 9: 240 / 138  | 9: 13 7     |
|       | 10: 380 / 220 | 10: 14 7    |
|       | 11: 400 / 230 | 11: 15 8    |
|       | 12: 415 / 240 | 12: 16 8    |
|       | 13: 480 / 277 | 13: 18 9    |
|       | 14: 20 10     | 14: 20 10   |

| Functional description |       |   |
|------------------------|-------|---|
| Pot. 1                 | Un    | Pos N° 0 = Auto Configuration position<br>Pos N° 1 to 13 = Preset Volt and Hz Config. |
| Pot. 2                 | ΔU ΔF | Delta U: Adjustable from 5 to 20%<br>Delta F: Adjustable from 3 to 10%                |
| Pot. 3                 | FT    | Supply Source Failure time: 0 to 60s  |
| Pot. 4                 | RT    | Supply Source Return Time: 0 to 60 min  |



Whatever Pot 1 trimming, it is IMPERATIVE to set Pots 2 to 4.

| Position setting identification |                         |           |            |            |            |            |            |            |            |            |            |            |            |            |            |          |
|---------------------------------|-------------------------|-----------|------------|------------|------------|------------|------------|------------|------------|------------|------------|------------|------------|------------|------------|----------|
| Pot                             | Setting                 | 0         | 1          | 2          | 3          | 4          | 5          | 6          | 7          | 8          | 9          | 10         | 11         | 12         | 13         | 14       |
| Pot 1                           | Un PhPh / PhN           | Auto Conf | 220 / 127V | 380 / 220V | 400 / 230V | 415 / 240V | 480 / 277V | 208 / 120V | 220 / 127V | 230 / 132V | 240 / 138V | 380 / 220V | 400 / 230V | 415 / 240V | 480 / 277V | -        |
|                                 |                         |           | Fréq.      | 50Hz       |            |            |            |            | 60Hz       |            |            |            |            | -          |            |          |
| Pot 2                           | Seuil U/F en % de Un/Fn | -         | 5 / 3%     | 6 / 3%     | 7 / 4%     | 8 / 4%     | 9 / 5%     | 10 / 5%    | 11 / 6%    | 12 / 6%    | 13 / 7%    | 14 / 7%    | 15 / 8%    | 16 / 8%    | 18 / 9%    | 20 / 10% |
| Pot 3                           | FT (s)                  | 0         | 1          | 2          | 3          | 4          | 5          | 8          | 10         | 15         | 20         | 30         | 40         | 50         | 60         | -        |
| Pot 4                           | RT (min)                | 0         | 1          | 2          | 3          | 4          | 5          | 8          | 10         | 15         | 20         | 30         | 40         | 50         | 60         | -        |

### 3 Auto configuration of mains voltage and frequency

The product includes an "Auto Configuration" feature to detect the mains voltage and frequency nominal values, phase rotation and neutral position and saves them in the ATS controller.

#### Note

Before configuring the nominal values ensure that the product is properly wired, verified and ready for commissioning. It is imperative that the network supply is available and that the wiring to the product voltage sensing terminals 103 – 106 and 203 – 206 has been done. It is preferable to use the product sensing kit that may be provided as an accessory.

- Ensure that the product is in manual mode and powered with Pot1 in position "Auto Conf".
- Press and hold the Red "PROG OK" button for >2s to measure the mains voltage and frequency.

#### Note

The source available LED will flash while the available network is being measured. The READY LED will flash green as soon as settings are measured and until these settings have been saved by pressing the PROG OK button a second time momentarily. (Refer to Step 4).

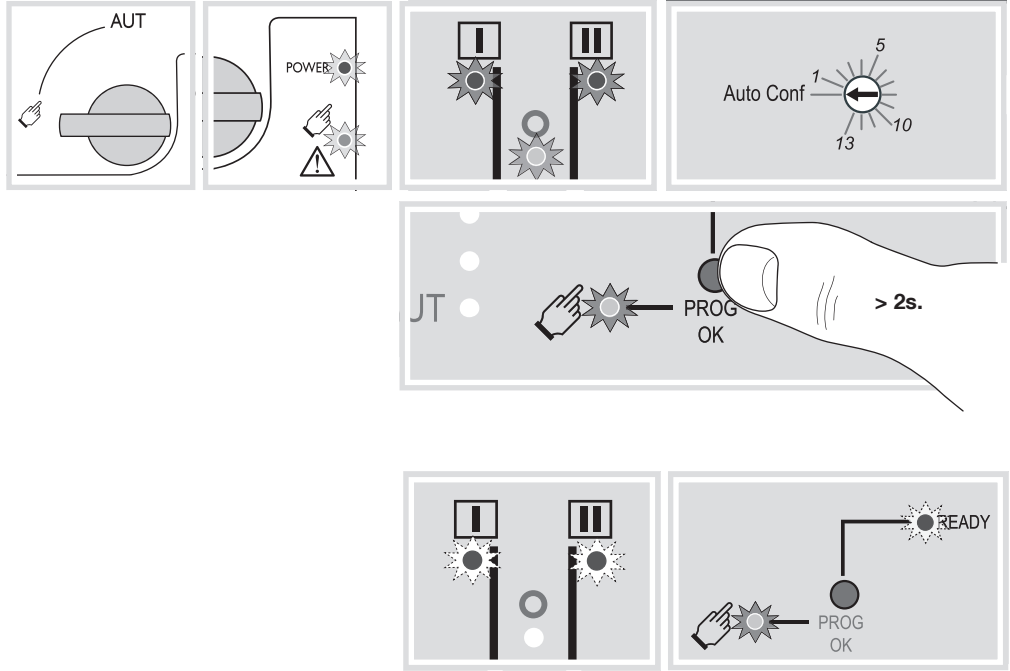

### 4 Saving the configured values

To SAVE the recorded setting configuration press the PROG OK button momentarily: <60ms.

#### Note

The flashing READY LED goes off once the values are saved in the ATS controller.

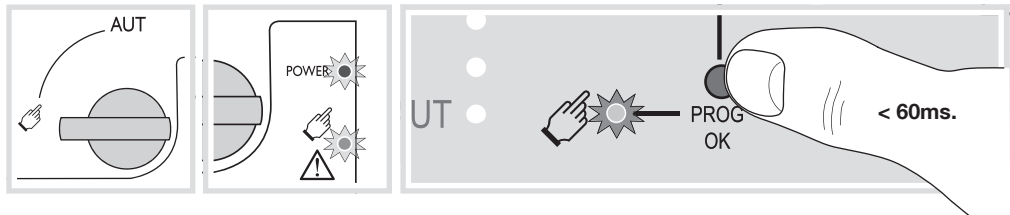

### 5 Putting the product into Auto operation

After following Steps 1 to 4, and once ready to put the product into AUTO operation turn the mode selector switch to Auto.

#### Note

When the product is powered and properly configured, after switching the product from Manual Mode to Auto Mode the READY light should be a steady green light.

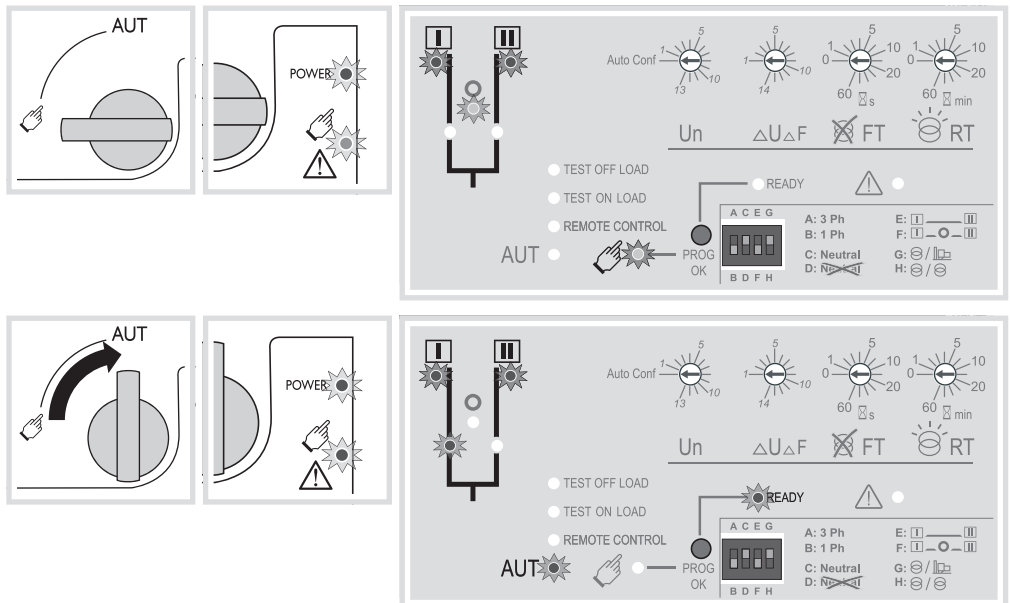

Depending on the state of the product the ATS automation may change the switch position as soon as the mode selector is switched to AUT. This is a normal operation.

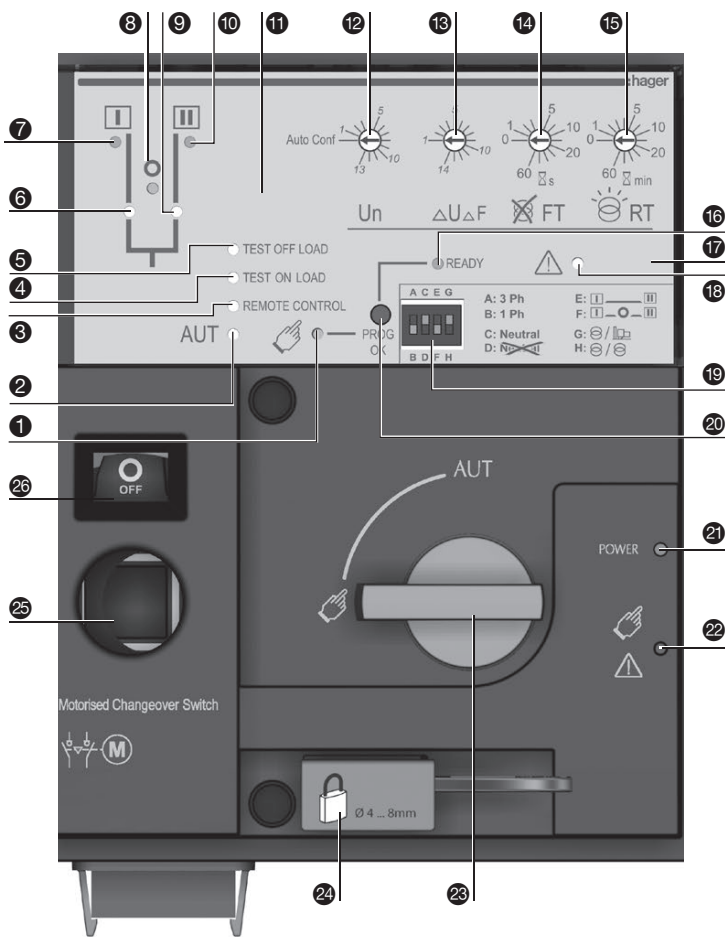

- 1 MANUAL Mode LED indication (yellow steady light when in Manual Mode)
- 2 AUTO Mode LED indication (Green steady light when in Auto mode with no timers running. Green flashing light when in Auto with timers running in the background.)
- 3 REMOTE CONTROL Mode LED indication. (Yellow steady light when in remote control mode. Remote control mode is achieved with the Auto/Manu selector switched to Auto and terminals 312 closed with terminal 317. Remote control orders are received through closing 314 to 316 with 317.)
- 4 TEST ON LOAD CONTROL Mode LED indication (yellow steady light when in TON mode).
- 5 TEST OFF LOAD CONTROL Mode LED indication (yellow steady light when in TOF mode).
- 6 Switch 1 LED position indication (green when in position 1).
- 7 Source supply I availability LED indication (green when supply I voltage is within the set limits).
- 8 Zero position LED indication (yellow when in position 0).
- 9 Switch 2 LED position indication (green when in position 2)
- 10 Source supply II availability LED indication (green when supply II voltage is within the set limits).
- 11 Sealing screw location 1 for use with sealing cover (available as an accessory)
- 12 Potentiometer 1: Network configuration (Auto configuration or refer to the configuration guide sticker on the front of the product when using the predefined setting positions 1 to 13).
- 13 Potentiometer 2: Voltage and Frequency threshold settings (refer to the configuration guide sticker on the front of the product to set the V/Hz threshold. Positions 1 to 14).

- 14 Potentiometer 3: Supply FAILURE Time (FT) Adjustable from 0 to 60 seconds
- 15 Potentiometer 4: Supply RETURN Time (RT) Adjustable from 0 to 60 minutes.
- 16 READY LED indication green steady light: Product in AUTO, Watchdog OK, Product Available to changeover. Green flashing: Settings displayed not saved or have been changed since last saved (press PROG OK button in manual mode to save or revert to last saved settings).
- 17 Sealing screw location 2 for use with the sealing cover.
- 18 FAULT LED indication (red steady light in case of an ATS controller internal fault).
- 19 Configuration dip switches: (4 dip switches with 2 positions in each A to H).
- 20 PROG OK: Configuration save push button (ATTN: Active in Manual Mode ONLY). Press briefly to confirm and save all set configuration settings. Hold pressed for 2 seconds to set the network supply voltage and frequency by Auto Configuration. This is to be followed by pressing briefly to save the set value configured.
- 21 Green LED Indication: Power
- 22 Red LED Indication: Product Unavailable/Manual Mode/Fault Condition
- 23 Auto/Manual mode selector switch (key version available as an option).
- 24 Padlocking facility (up to 3 padlocks of dia. 4 – 8mm)
- 25 Emergency manual operation shaft location (Accessible only in manual mode)
- 26 Switch position indication window: I (On switch I) O (Off) II (On switch II.)

### 7A. Automatic operation

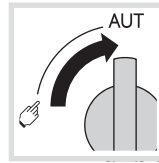

Ensure that the emergency handle is not inserted in the product and turn the mode selector to the AUT position.

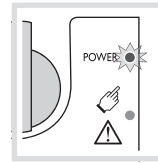

LED green = "Power": ON  
LED Manual/Default: OFF

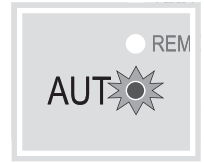

LED green "AUT": ON

### 7B. Automatic operation: remote control



#### Impulse logic

- Order I
- Order O
- Order II
- Position I
- Position O
- Position II

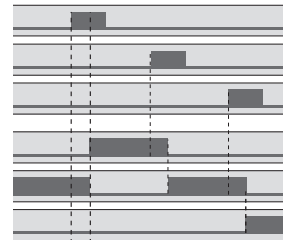

#### Contacting logic

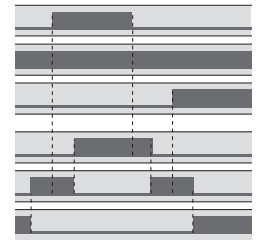

Impulse 60 ms  
Impulse maintained.

To enable control, close contact 312 with 317.

For contacting logic bridge contact 316 with 317.

To operate: close the contact corresponding to the desired position.

To force the product to 0 position "OFF" bridge contact 313 with 317.

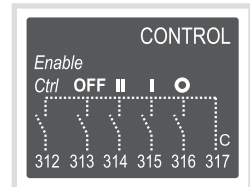

### 7C. Manual operation

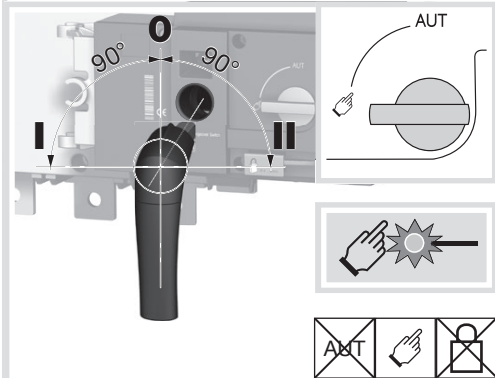

### 7D. Padlocking mode (Standard: in position O) Foreseen for max. 3 padlocks Ø 4-8mm

