

6LE000708B

2D

**REA1..Y**  
**Indoor station Audio surface-mounted 2Wire, TOUCH**

**REK2..Y**  
**Indoor station Audio angular surface-mounted 2Wire, TOUCH**

**Safety instructions**

Electrical equipment may only be installed and assembled by a qualified electrician in accordance with the relevant installation standards, guidelines, regulations, directives, safety and accident prevention regulations of the country.

When installing and laying cables, always comply with the applicable regulations and standards for SELV electrical circuits.

These instructions are an integral component of the product and must be retained by the end user.

GB

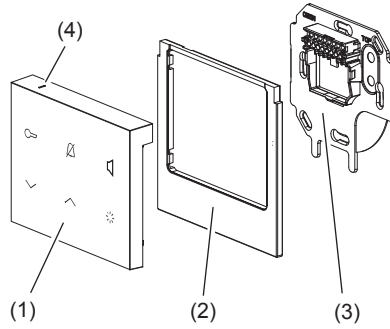
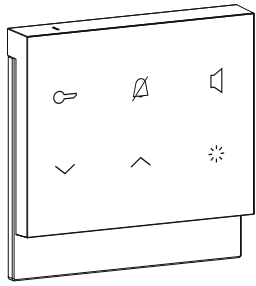

Figure 1: Design and layout of the device

- (1) Indoor station (operating unit)
- (2) Design frame (with REK2..Y included in scope of delivery)
- (3) Supporting plate with connection terminal block
- (4) Microphone

**Function**

The indoor station audio is a device for the 2-wire bus system. It can communicate with door stations and further indoor stations and unlock door releases.

**Correct use**

- For surface-mounting on a flat surface or for mounting on a wall box according to DIN 49073
- Only suitable for use in indoor areas with no drip and no spray water
- Not compatible with door communication systems of other manufacturers

**Product characteristics**

- Touch control panel with 6 symbol buttons, 3 are illuminated
- Hands-free or Push-to-Talk
- Ring tone volume and microphone sensitivity can be adjusted
- 16 ring tone melodies, individually assignable
- Connection for storey bell push-button
- storey call forwarding
- Parallel operation (a total maximum of 3 identically addressed indoor stations)
- Internal calls to other indoor stations
- Light button for activation of the light relay contact

**Operating concept**

Each of the 6 symbol buttons on the control panel (Figure 2) corresponds to a touch-sensitive surface. To trigger its function, it needs a push-button press with tactile feedback.

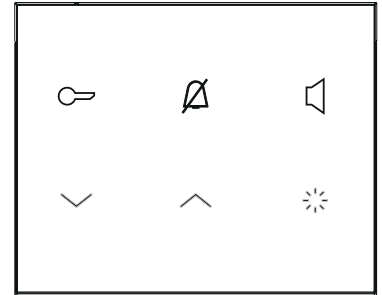

Figure 2: Control panel

All basic functions can be called up directly via the respective symbol button:

Symbol button LED	Function State
<b>door opener<sup>2)</sup> button</b> <i>lights up</i>	<b>unlock door</b> <i>door can be unlocked</i>
<b>mute button<sup>2)</sup></b> <i>flashes</i>	<b>mute ring tone</b> <i>ring tone muted</i>
<b>speech button<sup>2)</sup></b> <i>flashes</i> <i>lights up</i>	<b>accept call, end call,</b> switch on internal call mode <i>incoming call,</i> <i>internal call mode switched on</i> <i>call connection active</i>
<b>adjustment button down</b>	<b>decrease value,</b> Initiate internal call F/E
<b>adjustment button up</b>	<b>increase value,</b> Initiate internal call F/F
<b>light button<sup>2)</sup></b>	<b>switch on light<sup>1),</sup></b> <b>terminate setting mode</b>

1) requires a corresponding installation

2) with acknowledge tone

Table 1: Control panel buttons

By pressing the + buttons simultaneously the setting mode is activated (see audio settings).



In addition, the buttons<sup>2)</sup> do give an acoustic feedback after actuation:

- 1 acknowledge tone = function available
- 3 short tones = function not available
- 3 recurring tones = internal call mode

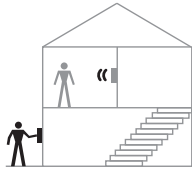
## Application 1: Door call



Outside on the door station the assigned call push-button is pressed.

The indoor station signals a door call:  
The ring tone melody sounds.  
The LED  flashes and the  lights up.

 Ring tone and LEDs signal the door call for a max. of 90 seconds.

### Accepting door call and establishing call

- Press the speech button .

A call to the door station is established.  
The LED  lights up permanently. The call connection is established (max. call duration 3 minutes).

- To end the call, press the speech button  again.  
Call connection and video connection are terminated.

or:

### Open door

- Press  door opener button.

The door of the calling door station is unlocked and can be opened. An active call is terminated automatically approx. 10 seconds after the unlocking.

 Direct door release: In systems with only one door station, the door can be unlocked even without a preceding door call if the door station has been configured accordingly.

### Switch-on lights

The light (e.g. stair light) can be switched on if the associated automatic light is connected to the line power supply with relay.

- Press  light button.

The light is switched on<sup>1)</sup>.

<sup>1)</sup> requires a corresponding installation

### Mute ring tone

The ring tone can be muted if necessary.

The indoor station is in standby mode.

- Press the mute  button.

The LED  flashes. The ring tone melody is deactivated.

- Press the mute  button once again.

The LED  goes out. The ring tone melody is reactivated.

 The mute function should only be used as briefly as possible in order not to miss any door calls.

## Application 2: Storey call



If the storey bell push-button connected to the indoor station is pressed, a storey call is signalled:



The ring tone melody for the storey call sounds on the indoor station.

 If, in the apartment or building unit (i.e. in the same system branch), up to 2 further, identically addressed indoor stations are installed, these also signal the storey call (storey call forwarding<sup>3)</sup>).

<sup>3)</sup> requires the appropriate default setting by the installer (see setting operating modes)

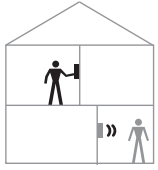
## Application 3: Internal call<sup>3)</sup>





In the door communication system, internal calls from indoor station to indoor station are possible. The internal call function uses the fixed addresses *F/E* or *F/F* as call destination. The  and  buttons are configured for this purpose (Table 1).

### Initiating internal call

The indoor station is in standby mode (no call). The internal call address *F/E* or *F/F* is set on the indoor station to be called.

- Press the speech button .

The dial tone for internal call sounds (recurring tone sequence from 3 identical tones).  
The LED  lights up.

- Press the  button to call the indoor station with address *F/E*.

or:

- Press the  button to call the indoor station with address *F*.

After the button is pressed, an acknowledge tone can be heard.

If the internal call on the indoor station receiving the call is accepted, the call connection is established.



- Pressing the speech button  again terminates the connection on one of the two indoor stations.

<sup>3)</sup> requires the appropriate default setting by the installer (see setting operating modes)



## Audio settings (Figure 3)

### Setting the microphone sensitivity

During an active call connection, the microphone sensitivity is adjustable.

- Keep  +  buttons pressed simultaneously for 3 seconds.

The setting mode activates itself with an acknowledge tone. The call connection remains active.

- Adjust the microphone sensitivity incrementally with  / .

Each of the 5 adjustment levels has its own acknowledge tone. The higher the tone, the higher the microphone sensitivity.

 In hands-free mode, the changeover between listening and speaking takes place automatically depending on the volume. The changeover behaviour can be optimised by adjusting the microphone sensitivity. As a result, the influence of background noise in the area of the indoor station can be reduced.

### Activating Push-to-Talk

In **Push-to-Talk** mode the changeover between listening and speaking takes place manually with the speech button.

Speech button 	Function
keep pressed	speak
release	listen
short press	end call

- During an active call connection, keep the  button pressed for more than 2 seconds.

For the current call, hands-free mode is changed to Push-to-Talk mode.

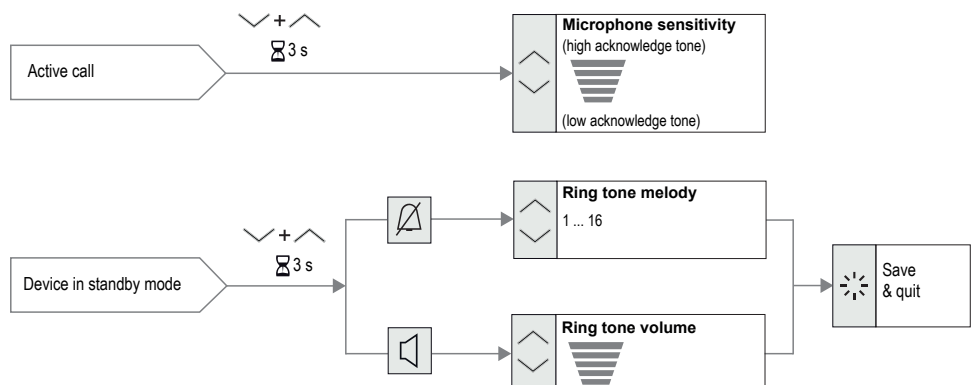

Figure 3: Audio settings

## Selecting and assigning ring tone melodies

You can choose from 16 ring tone melodies. Individual ring tone melodies can be assigned for door calls, storey calls and internal calls. The melody for the station that made the last call or the connected storey push-button is always set. A separate melody that can be changed is already preset for storey calls and internal calls.

The indoor station is in standby mode.

- Keep  $\vee$  +  $\wedge$  buttons pressed simultaneously for 3 seconds.

The setting mode activates itself with an acknowledge tone.

- Press  $\text{A}$  button.

The current ring tone melody sounds.

- With  $\vee$  /  $\wedge$  listen to other ring tone melodies until the melody sounds that you wish to use.

- Assign the ring tone melody with the  $\text{A}$  button.

The setting mode is completed.

- Afterwards, another call event can be generated, e.g. storey call, and a separate ring tone melody can be assigned to this according to the same procedure.

## Increasing/decreasing ring tone volume

The ring tone volume can be adjusted in 3 levels.

The indoor station is in standby mode.

- Keep  $\vee$  +  $\wedge$  buttons pressed simultaneously for 3 seconds.

The setting mode activates itself with an acknowledge tone.

- Press  $\text{A}$  button.

The current ring tone melody sounds.

- Adjust the ring tone volume incrementally with  $\vee$  /  $\wedge$ .

- With the  $\text{A}$  button save the setting and terminate the setting mode.

## Information for electricians

### Addressing and default settings

The device addressing and setting of the operating modes must already be carried out prior to installation using the rotary switch and DIP-switch on the back of the device (Figure 4).

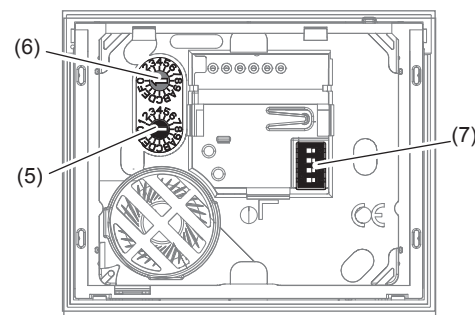

Figure 4: Rear view

- (5) Address rotary switch (black) for group address
- (6) Address rotary switch (blue) for intercom device address
- (7) DIP-switch for operating modes

### Addressing the device

The indoor station can be addressed quickly and easily using both address rotary switches (5), (6). The address to be set is 2-digit, comprising group address and intercom device address. It must be identical with the address of the associated call push-button on the door station. Figure 5 shows the structure of the address by way of example:

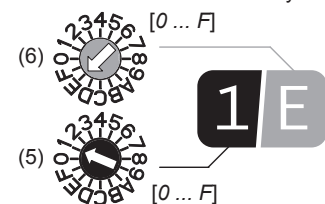

Figure 5: Example address "1/E"

- On the black rotary switch (5) set the **group address** [0 ... F].
- On the blue rotary switch (6) set the **intercom device address** [0 ... F].
- A maximum of 3 indoor stations with the identical address setting may be installed for the parallel operation.
- For door stations with automatic call push-button addressing also see operating instructions of the door station. For door stations with push-button interface/expander see operating instructions of the interface.

### Setting operating modes

- Set the DIP-switch for operating modes (7) according to Table 2 below.

Switch	Function (Factory setting = OFF)
1	OFF Hands-free mode: automat. Half duplex, switchable to Push-to-Talk via speech button
	ON Push-to-Talk: manual half duplex speech mode, set permanently
2	OFF Storey call forwarding blocked
	ON Storey call forwarding to max. 2 indoor stations with the same address in the same branch
3	OFF Internal call function deactivated
	ON internal call function activated (see application 3)
4	OFF Normal operation, no parallel call to intercom device address 0
	ON Parallel call to intercom device address 0 with identical group address

Table 2: DIP-switch settings

## Installation and electrical connection

The supporting plate (3) must be mounted on the wall before wiring.

### Mounting the supporting plate

A 2-wire bus cable, and if necessary, a connection cable of the storey push-button are laid to the mounting location.

- Recommended installation height: 1.5 m.

- Separate supporting element (8) on the pre-determined breaking point from the supporting plate.

For installation on a wall box (Figure 6):

- Mount the supporting element (8) onto wall box so that the smooth surface is pointing straight ahead and the outer cable tie mounts (9) are lying on the screw domes of the wall box.
- Pre-align supporting element with 2 screws.

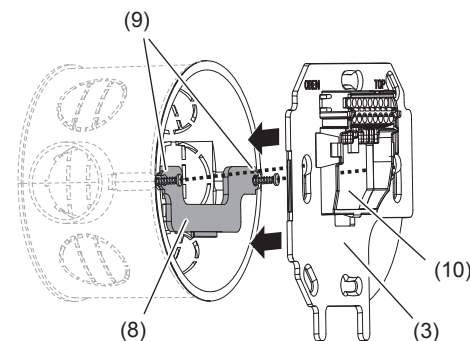

Figure 6: Installation on a wall box

- (8) Supporting element

- (9) Cable tie mounts

- (10) Opening to the cable bushing

For surface-mounting without wall box:

- Mark the fixing holes with supporting plate (3). Observe alignment marks.

- Drill fixing holes and insert dowels.

For both installation modes:

- Run the stripped 2-wire bus cable through the middle opening (10) of the supporting plate.
- Also run the connection cable of the associated storey push-button through.
- Mount the supporting plate (3) onto the wall or wall box with at least 2 screws. Observe alignment marks.

## Connect device

Figure 7 shows a schematic view of the connection from the audio indoor stations to the system line power supply:

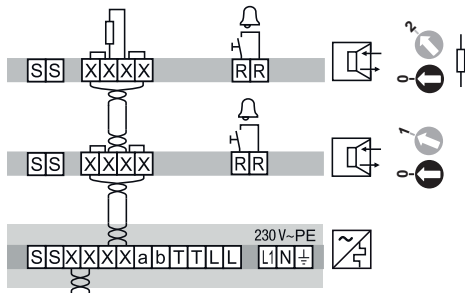





Figure 7: Connection to line power supply

 Indoor station audio

 Line power supply RMD

 Wrapped wire pair for 2-wire devices  
(recommendation: white/yellow wire pair)

Additional audio and video stations can be connected according to this principle.

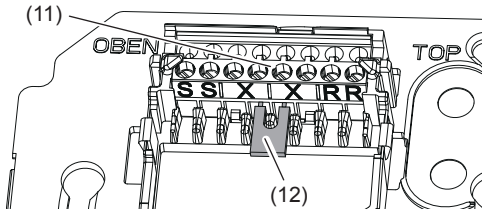



Figure 8: Connection terminal block

(11) Connection terminal block

(12) Terminating resistor/terminator

 For detailed system connection diagrams and information about cables see operating instructions of the line power supply.

■ Connect the stripped wires of the 2-wire bus cable to the connecting terminals **X/X**.

 Both terminals **X/X** are each implemented twice (bridged) for incoming and outgoing 2-wire bus cables (Figure 7).

■ If the indoor station is not the last intercom device in the branch/line, then remove the terminating resistor/terminator (12) from the terminals **X/X**.

■ Connect the associated storey push-button to the connecting terminals **R/R**.

 The terminals **S/S** are used for connecting the additional power supply, if necessary.

## Mounting indoor station (operating unit) (Figure 9)

■ Mount design frame (2) in correct position on the back of the operating unit.

 Depending on the design, the design frame is closed shaped as in figure 9 or U-shaped.

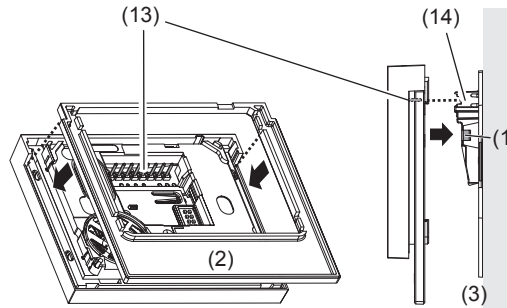

Figure 9: Installation

(13) Pin header of the operating unit

(14) Cable connector of the connection terminal block

(15) Locking hook

■ Align the indoor station (3) so that the backside pin header (13) is pointing to the pin header of the connection terminal block (14).

■ Mount the indoor station onto the supporting plate and carefully press on until the locking hooks (15) interlock.

## Appendix

### Technical data

Supply voltage <b>X/X</b> via bus	22 ... 24 V=
Current consumption (operation)	max. 180 mA
Current consumption (Stand-by)	≈ 9 mA
Max. sound pressure level ring tone via loudspeaker at a distance of 0.5 m	78 dB(A)
Call volume (hands-free)	max. 65 dB(A)
Degree of protection	IP 30
Operating temperature	5 ... 50 °C
Connecting terminal for conductor cross-section	max. 0.75 mm <sup>2</sup>
Dimensions without Design frame (W x H x D)	93 x 74.3 x 16 mm

### Standards

Ring tone volume (signal) according to EN 50486

### Warranty

We reserve the right to realise technical and formal changes to the product in the interest of technical progress.

Our products are under guarantee within the scope of the statutory provisions.

In case of service issues, please contact your systems' engineer.