

**EN** Programmable ambient thermostat,  
2 wire, weekly, battery powered

Notice d'instructions

This programmable ambient thermostat has been designed to bring you comfort and energy economy. It allows you to program and regulate your heating system at 3 temperature levels:

- Comfort ☼: this is the temperature you desire during the hours you are present.
- Eco ☾: this is the temperature you desire during short absences or at night.
- Frost protection ❄: this is the guaranteed minimum temperature during your prolonged absences. It protects your accommodation against the dangers of frost.

## EK570

### Product description

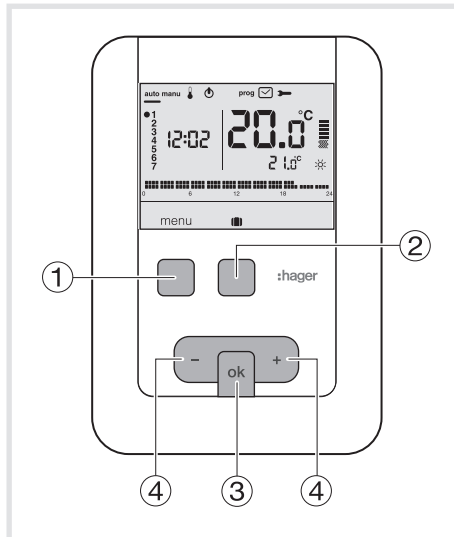

- ① Context key for **menu** access
- ② Context key for mode access holidays
- ③ Confirmation key **OK**
- ④ Adjustment keys **+** and **-**

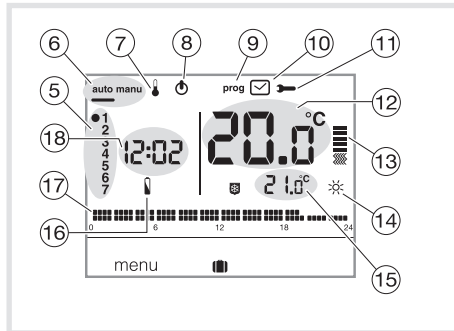

- ⑤ Indicator for days of the week
- ⑥ Automatic mode/manual mode (thermostat without program)
- ⑦ Temperature settings adjustment
- ⑧ Standby
- ⑨ Programming/program selection
- ⑩ Time and date adjustment
- ⑪ Adjustment of settings
- ⑫ Ambient temperature
- ⑬ Heating indicator
- ⑭ Current setting (☼, ☾, ❄)
- ⑮ Temperature of current setting
- ⑯ Battery use indicator
- ⑰ Profile of today's program
- ⑱ Current time

### Electrical installation and connections

To guarantee its ambient temperature-regulation function, the thermostat should be installed around 1.3 m above the ground, on an interior wall and away from direct sunlight or any heat source such as a television, lamp, radiator, draft, chimney, etc. Fix the thermostat onto the flush-mounted casing or in the slot without a casing intended for this purpose.

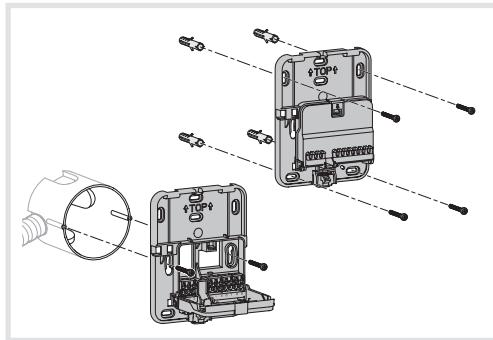

For optimum quality temperature regulation, seal the flush-mounted casing or the electrical duct.

1. Separate the product from the wall-mounted base, by pushing on the button located under the base.

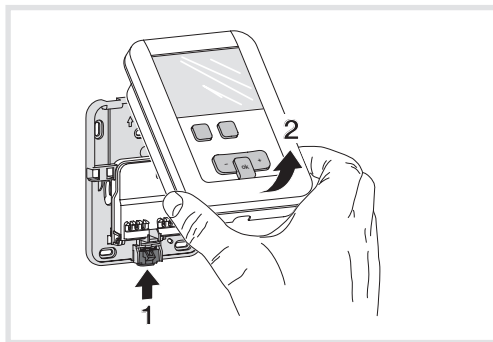

2. Open the flap with the help of a screwdriver and attach the wall-mounted base using the screws.
3. Next, pass the electrical cables into the holes intended for this purpose.

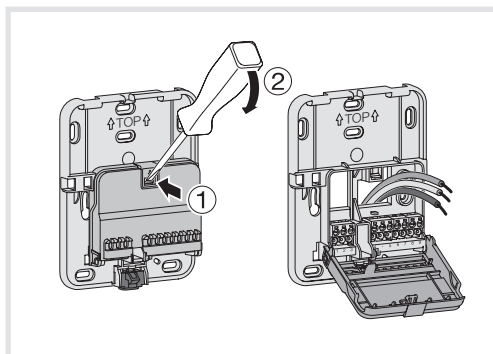

4. Connect the product according to the wiring diagram below.
5. Reclose the flap
6. Insert the batteries into the thermostat.

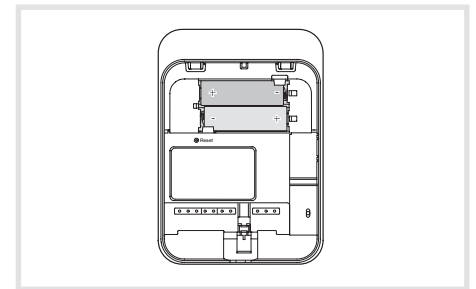

7. Clip the front face onto the wall-mounted base.

### Connection of the thermostat to a thermostat input on the boiler

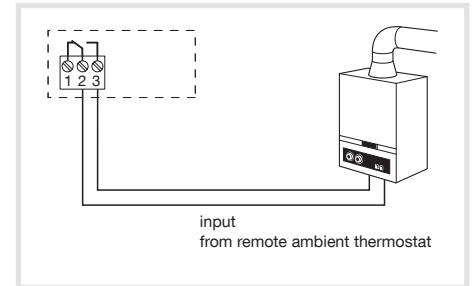

### Connection of a heat circulator

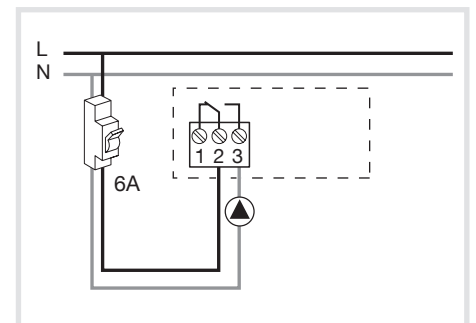

This product must be installed according to the local standards in force.

## Initial adjustment and updating

when the product is first used, the screen offers the option to adjust the year, date and time, without going into the parameter settings.

or  
Press key ① menu to place the cursor under .

- The year flashes, press key ④ + the navigation key to adjust the current year. Confirm using the OK key.
- The month flashes. Now press key ④ + or -. Confirm using the OK key then proceed in the same manner to select the day, hour and minutes.
- AUTO AUTO flashes. Press key ④ + to set the installation to switch automatically between summer and winter time (AUTO) or not (OFF). Confirm using the OK key.
- 24.H flashes. Press key ④ + and select the 12 hour or 24 hour time format. Confirm using the OK key.

## Automatic mode (auto)

In automatic mode, the thermostat adapts itself to the rhythm of your life by applying one or more programs that you have selected.

- Press key ① menu to place the cursor under auto.
- Key ① menu allows you to return to auto mode when the (holiday) program is running.

## Manual mode (manu)

Manual mode transforms your equipment into a simple thermostat. It allows you to maintain a constant temperature in your accommodation (adjustable from +5 °C to +30 °C) and ignores the available program profiles.

- Press key ① menu to place the cursor under manu.
- Press key ④ + or - to adjust the desired temperature.

Example: the desired temperature is at 22.5 °C and the ambient temperature at 20 °C. The heating running indicator  is illuminated.

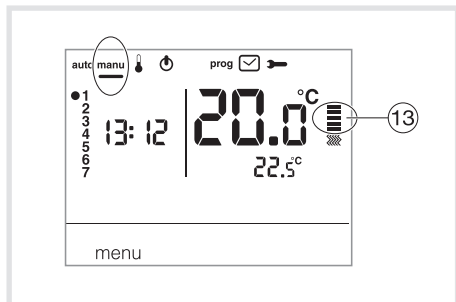

## Standby mode

The heating system can be put on standby. The thermostat is live and protects your installation if the temperature drops below 5 °C (fixed non-modifiable instruction). It displays the time, current day, ambient temperature and Off information.

- Press key ① menu to place the cursor under .
- OFF flashes.
- Confirm using the OK key.
- Press key ① menu to exit standby mode.

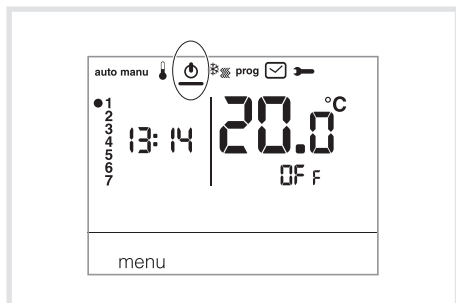

## Installer parameters

To access all of the parameters (from PR:3 to PR:12), press key ① menu to place the cursor under  then give 1 long push (>5s) on OK.

### PR:3 - Temperature calibration

This parameter lets you adjust the value displayed by the thermostat if you measure a different ambient temperature to that which the thermostat measures.

- Press key ④ + or - to modify the temperature within a range of +/-3 °C. Confirm using the OK key to pass to the next parameter.

### PR:5 - Degumming the pump

This parameter allows you to activate/deactivate the automatic start-up of the pump at midnight every day, in order to avoid its jamming during the summer.

- Press key ④ + or - to activate (ON) or deactivate (OFF). Confirm using the OK key to pass to the next parameter. Parameter PR:5 is set to OFF by default.

### PR:10 - Return to factory settings

This parameter lets you return programs and parameters to the factory settings.

- Press key ④ + or - to choose YES (reset) or NO (no de reset). Confirm using the OK key to pass to the next parameter.

### PR:12 - Software version

This parameter displays which version of the software is installed in the product. Press OK to exit from parameter adjustments.

## User parameters

To access the user parameters, press key ① menu to place the cursor under  and confirm using the OK key.

### PR:3 - Temperature calibration

This parameter lets you adjust the value displayed by the thermostat if you measure a different ambient temperature to that which the thermostat measures.

- Press key ④ + or - to modify the temperature within a range of +/-3 °C. Confirm using the OK key.

Once adjustment of this parameter is carried out, the thermostat switches to auto mode and takes account of this modification.



## Holiday mode

This mode protects your accommodation against the dangers of frost and maintains a minimum temperature during your absences, which can be adjusted between 5 °C and 30 °C. You can program the duration of your absence to anticipate a rise in temperature for your return.

- Press key ② , press key ④ + to select the number of days absence (from 1 to 99 days).

### The current day counts as 1.

Confirm using the OK key.



- The icon  appears and the temperature to be adjusted flashes.
- Press key ④ + or - to indicate the desired temperature value. Confirm using the OK key. Leave the thermostat in this mode. To cancel and return to automatic mode, press key ① menu.
- To modify the duration of your absence or the temperature value, press key ②  and proceed to the changes.

## Adjusting the temperature set-points

The temperatures are preset:  
Comfort = 19 °C, Eco = 16 °C.

The adjustment range for the heating settings is from 5 °C to 30 °C.

### Modification of the Comfort temperature

- Press key ① menu to place the cursor under .
- The Comfort temperature  flashes.
- Press key ④ + or - to modify the temperature. Confirm using the OK key.

### Modification of the Eco temperature

- The Eco temperature  flashes.
- Press key ④ + or - to modify the temperature. Confirm using the OK key.

## Programming

Four programs are available to program your week: *P1*, *P2*, *P3* which are pre-recorded and not modifiable and *P4* which is free and allows you to create a personalised program that can be different for each day of the week.

*P1* = Comfort temperature from **06:00 to 23:00**.  
Eco temperature from **23:00 to 06:00**.

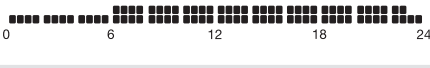

 *P1* is activated 7 days per week by default. If this fits the rhythm of your life then remain in automatic mode; if not, continue.

*P2* = Comfort temperature from **06:00 to 08:30** and from **16:30 to 23:00**.  
Eco temperature from **08:30 to 16:30** and from **23:00 to 06:00**.

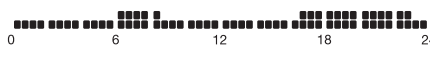

*P3* = Comfort temperature from **06:00 to 08:30**, from **11:30 to 13:30** and from **16:30 to 23:00**.  
Eco temperature from **08:30 to 11:30**, from **13:30 to 16:30** and from **23:00 to 06:00**.





*P4* = a free program which allows you to create up to 5 Comfort temperature periods and 5 Eco temperature periods, for each of the days of the week.

## Creation of a personalised program P4









This program allows you to adjust the heating to suit your way of life.

A 24-hour profile is composed of 48 points (representing the set-points). You can visualise the composition of your program at the bottom of the display. 1 program step = 30 minutes.

	
30 min. in Eco	30 min. in Comfort

Example: creating a program, **P4**, for a group of days (5 weekdays + 2 weekend days).  
For the 5 weekdays, we would like 3 Comfort periods from 06:00 to 08:00, from 12:00 to 14:00 and from 18:00 to 22:00.

For the two-week in days, we would like one Comfort period from 08:00 to 22:00.

- Press key ①  to place the cursor under **prog**. The indicators for the seven days of the week flash.
- Press key ④ + to select to affect the group of five days (the group of five days flashes). Confirm using the **OK** key.
- *P1* flashes. Press key ④ + to select *P4* (*P4* flashes). Confirm using the **OK** key.
- Press key ①  until 6:00 appears and key ②  until 8:00 appears. Next press key ①  until 12:00 and key ②  until 14:00. Then press key ①  until 18:00 and finally key ②  until 22:00. If you make an error, press key ④ - to move back or key ④ + to advance and correct your programming.
- Confirm using the **OK** key.
- The group of 2 weekend days flashes. Confirm using the **OK** key.
- *P1* flashes. Press key ④ + to select *P4* (*P4* flashes). Validez avec la touche **OK**.
- Press key ①  until 8:00 is reached and then press key ②  until 22:00. Confirm using the **OK** key.

Note:

The latest *P4* program is held in memory and automatically offered to be assigned to a new day or group of days (whose *P4* is empty).

## Temporary override

### By overriding until the next program step

In **auto** mode, it is possible to modify the temperature of the current set-point.

- Press key ④ + or - to increase or decrease the displayed set-point temperature. The set-point temperature flashes and the override is valid until the next program step.

During the override period, the current set-point temperature flashes.

## What to do if... ?

### The symbol is displayed:

change the batteries (2 alkaline batteries of type LR06 1.5 V) as soon as possible.

## Technical characteristics

Power supply: 2 alkaline batteries 1,5V (type LR06)  
 Battery lifespan: 4 years  
 Static differential (On/Off regulation): < 0,3 °C  
 Power reserve: 10 min.  
 Adjustment range:  
 - Comfort temperature: +5 °C to +30 °C  
 - Eco temperature: +5 °C to +30 °C  
 Ambient temperature display range:

0 °C to +40 °C  
 Operating temperature: +0 °C to +45 °C  
 Storage temperature: -25 °C to +70 °C  
 Ball test temperature: 75 °C and 125 °C  
 Clock operating accuracy: drifts < 1sec/day  
 Trip values: 230V ~ 5A resistive / 3A inductive  
 Minimum load excepted by the relay: 12V/10mA  
 Relative humidity: 90 % at 20 °C  
 IP: 30  
 Ecodesign class: 4  
 IK: 04  
 Insulation class: II  
 Insulation type: 4kV  
 Rigid cable cross-sections: 0,5 to 2,5 mm<sup>2</sup>  
 Flexible cable cross-sections: 0,5 to 1,5 mm<sup>2</sup>  
 Minimum pulse voltage: 4 kV  
 Pollution class: 3  
 Action type: 2B  
 Insulation type: reinforced insulation  
 Software structure: class A  
 Dimensions (l x h x d): 97 x 138 x 30  
 Voltage and current declared for the needs of EMC emissions tests: 230V ~ 0,5A  
 Upstream protection: circuit breaker 6A  
 Independent installation device for built-in installation

## Assigning an existing program (P1, P2 or P3) to one or more days of the week

You can assign any of the programs to all 7 days of the week, to a group of five weekdays, to a group of two days for the weekend or to an individual day.

- Press key ①  to place the cursor under **prog**. The indicators for the seven days of the week flash.
- Press key ④ + to select which day, or group of days, to assign a program to. Confirm using the **OK** key.
- *P1* flashes. Press key ④ + to select the program to apply. Confirm using the **OK** key.

As an example, to assign *P2* to the group of five weekdays and *P1* to the group of two weekend days:

- Press key ①  to place the cursor under **prog**. The indicators for the seven days of the week flash.
- Press key ④ + to select to affect the group of five days (the group of five days flashes). Confirm using the **OK** key.
- *P1* flashes. Press key ④ + to select (*P2* flashes). Confirm using the **OK** key.
- Press key ④ + to select the group of 2 weekend days (the group of 2 weekend days flashes). Confirm using the **OK** key.
- *P1* flashes. Confirm using the **OK** key. The thermostat returns to **auto** mode.



**Correct Disposal of This product (Waste Electrical & Electronic Equipment)**

(Applicable in the European Union and other European countries with separate collection systems).

This marking shown on the product or its literature indicates that it should not be disposed with other household waste at the end of its working life. To prevent possible harm to the environment or human health from uncontrolled waste disposal, please separate this from other types of wastes and recycle it responsibly to promote the sustainable reuse of material resources. Household users should contact either the retailer where they purchased this product, or their local government office, for details of where and how they can take this item for environmentally safe recycling.

Business users should contact their supplier and check the terms and conditions of the purchase contract. This product should not be mixed with other commercial wastes of disposal.

Usable in all Europe  and in Switzerland

