

EN Programmable ambient thermostat,
2 wire, weekly, battery powered

User instructions

EK520

Product description

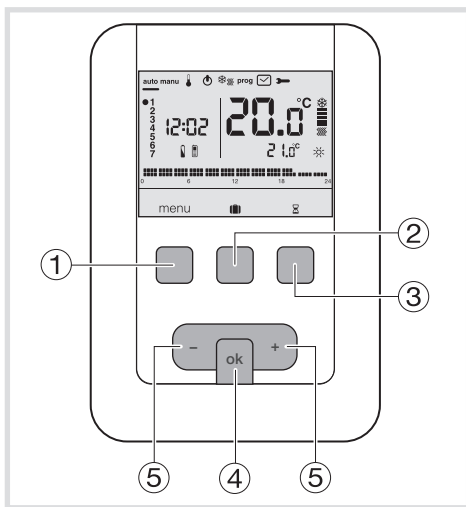

- ① Context key for **menu** access
- ② Context key for mode access holidays
- ③ Context key to access the temporary override
- ④ Confirmation key **OK**
- ⑤ Adjustment keys **+** and **-**
- ⑥ Indicator for days of the week

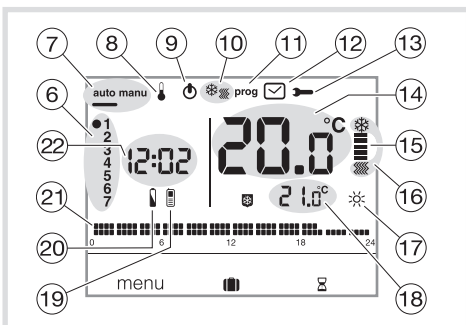

- ⑦ Automatic mode/manual mode (thermostat without program)
- ⑧ Temperature set-points adjustment
- ⑨ Standby
- ⑩ Heating/Air-con selector
- ⑪ Programming/program selection
- ⑫ ATime and date adjustment
- ⑬ Adjustment of settings
- ⑭ Ambient temperature
- ⑮ Heating or air conditioning indicator
- ⑯ Current mode (heating or air conditioning)
- ⑰ Current setting (☀, ☀, ☾, ❄)
- ⑱ Temperature of current setting
- ⑲ Telephonic remote-control
- ⑳ Battery use indicator
- ㉑ Profile of today's program
- ㉒ Current time

Electrical installation and connections

To guarantee its ambient temperature regulation function, the thermostat should be installed at least 1.3 m above the ground, on an interior wall and away from direct sunlight or any heat source such as a television, lamp, radiator, draft, chimney etc. Fix the thermostat onto the flush-mounted casing or in the slot without a casing intended for this purpose.

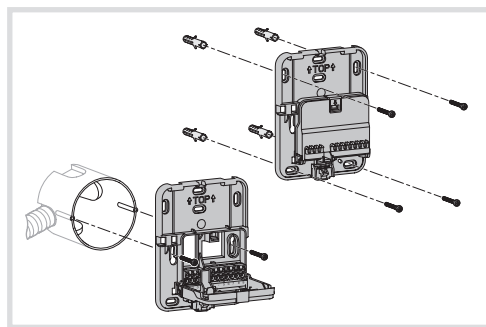

For optimum quality temperature regulation, seal the flush-mounted casing or the electrical duct.

1. Separate the product from the wall-mounted base, by pushing on the button located under the base.

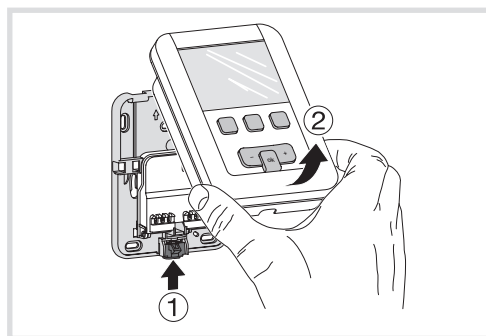

2. Open the flap with the help of a screwdriver and attach the wall-mounted base using the screws.
3. Next, pass the electrical cables into the holes intended for this purpose.

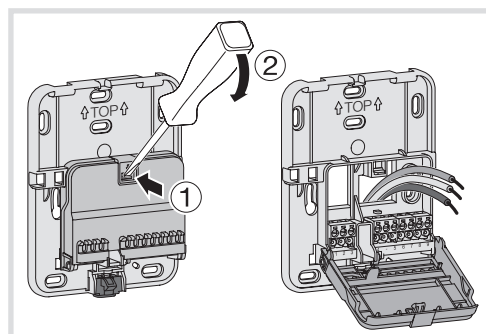

4. Connect the product according to the wiring diagram opposite.
5. Reclose the flap

6. Insert the batteries into the thermostat.

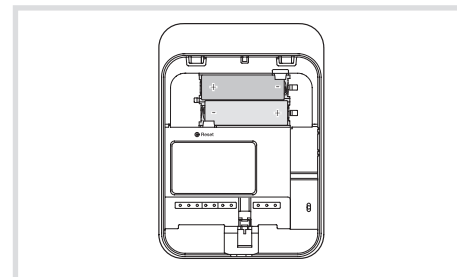

7. Clip the front face onto the wall-mounted base.

Connection of the thermostat to a thermostat input on the boiler

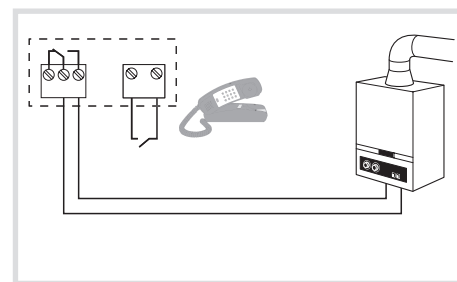

Connection of the thermostat to the thermostat input of a reversible or irreversible heat pump (HP)

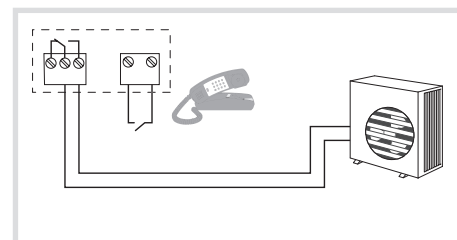

Connection of a heating or air conditioning circulator

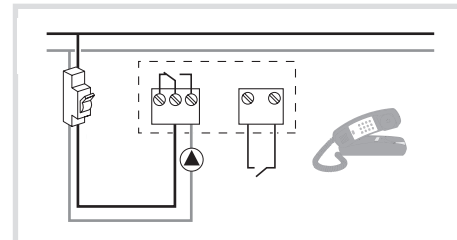

Installation must be carried out by professional in accordance with the standards in force.

Initial adjustment and updating

When the product is first used, the screen offers the option to adjust the year, date and time, without going into the parameter settings.

or
Press key ① menu to place the cursor under

- The year flashes, press key ⑤ + the navigation key to adjust the current year. Confirm using the OK key.
- The year flashes, Now press key ⑤ + or - . Confirm using the OK key then proceed in the same manner to select the day, hour and minutes.
- AUTO flashes. Press key ⑤ + to set the installation to switch automatically between summer and winter time (AUTO) or not (OFF). Confirm using the OK key.
- 24:H flashes. Press key ⑤ + and select the 12 hour or 24 hour time format. Confirm using the OK key.

Automatic mode (auto)

Manual mode transforms your equipment into a simple thermostat. It allows you to maintain a constant temperature in your accommodation (adjustable from +5°C to +30°C) and ignores the available program profiles.

- Press key ① menu to place the cursor under auto.
- Key ① menu allows you to return to auto mode when the (holiday) program is running or a timed restart is in progress.

Manual mode (manu)

Manual mode transforms your equipment into a simple thermostat. It allows you to maintain a constant temperature in your accommodation (adjustable from +5°C to +30°C) and ignores the available program profiles.

- Press key ① menu to place the cursor under manu.
- Press key ⑤ + or - to adjust the desired temperature.

Example: the desired temperature is at 22.5°C and the ambient temperature is 20°C. The heating-activated indicator ⑮ is illuminated.

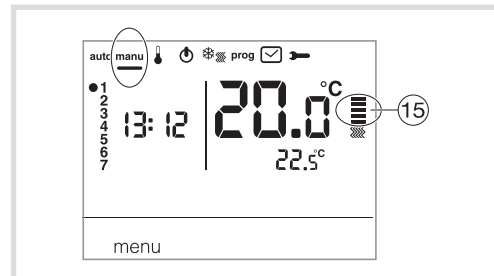

Standby mode

The heating and/or air conditioning system can be put on standby. The thermostat is live and protects your installation if the temperature drops below 5°C (fixed non-modifiable instruction). It displays the time, current day, ambient temperature and Off information.

- Press key ① menu to place the cursor under
- OFF flashes.
- Confirm using the OK key.
- Press key ① menu to exit standby mode. From air conditioning mode, standby mode represents a stop command and the ambient temperature is no longer regulated.

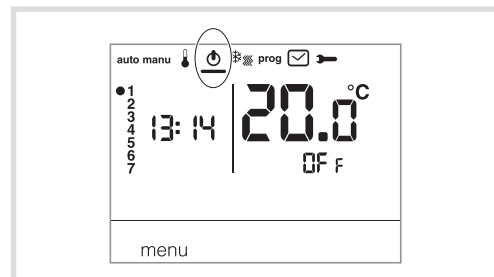

Installer parameters

To access all the parameters (from PR:1 to PR:12), press key ① menu to place the cursor under and then give one long press (>5s) on OK.

To only access parameters from (PR:1 to PR:4), press key ① menu to place the cursor under and confirm using the OK key.

<p>PR:1 - Default duration of the temporary override</p> <p>This parameter allows you to input a default, restart time delay. Possible delay times are the following: 1 hour, 2 hours, 3 hours, 4 hours, 5 hours and 12 hours. The restart delay is set to 1 hour by default.</p> <ul style="list-style-type: none"> PR:1 and flash. Press key ⑤ + or - to modify the restart delay. Confirm using the OK key to pass to the next parameter. 	
<p>PR:2 - Backlighting</p> <p>Backlighting is activated (ON) by default.</p> <ul style="list-style-type: none"> Press key ⑤ + or - to deactivate it (OFF). Confirm using the OK key to pass to the next parameter. 	
<p>PR:3 - Temperature calibration</p> <p>This parameter lets you adjust the value displayed by the thermostat if you measure a different ambient temperature to that which the thermostat measures.</p> <ul style="list-style-type: none"> Press key ⑤ + or - to modify the temperature within a range of +/-3°C. Confirm using the OK key to pass to the next parameter. 	
<p>PR:4 - 2nd Comfort temperature level</p> <p>This parameter allows you to select one or two Comfort temperature levels. It is only applicable during programming of the free program (P4).</p> <ul style="list-style-type: none"> Press key ⑤ + or - to choose 1 or 2. Confirm using the OK key to pass to the next parameter. Parameter PR:4 is set to 1 single level of Comfort by default. 	
<p>PR:5 - Heating/Air-con mode</p> <p>This parameter allows you to put your installation into Heating mode (H), Air conditioning mode (L) or reversible Heating/Air-con mode (HL) (the icon is displayed).</p> <ul style="list-style-type: none"> Press key ⑤ + or - to select H, L or HL. Confirm using the OK key to pass to the next parameter. Parameter PR:5 is set to heating (H) by default. In HL mode, care should be taken to switch the HP suitably for the chosen thermostat mode. 	
<p>PR:5 - Degumming the pump</p> <p>This parameter allows you to activate/deactivate the automatic start-up of the pump at midnight everyday, in order to avoid its jamming during the summer.</p> <ul style="list-style-type: none"> Press key ⑤ + or - to activate (ON) or deactivate (OFF). Confirm using the OK key to pass to the next parameter. Parameter PR:5 6 is set to OFF by default. 	
<p>PR:7 - Type of heating regulation</p> <p>This parameter lets you define the type of inertia of your heating installation.</p> <ul style="list-style-type: none"> Press key ⑤ + or - to select: <ul style="list-style-type: none"> ON/OFF = On or off (default setting). The differential is less than 0.3°C (factory setting). FR5 = PID regulation for installations with rapid inertia (radiator). Minimum run time 1 minute (10% of the cycle time). SL0 = PID for installations with slow inertia (underfloor heating). Minimum run time 2 minutes (10% of the cycle time). Confirm using the OK key to pass to the next parameter. <p>In On/Off regulation, only the anticipation function is available, see PR:9 In PID regulation, the optimisation and anticipation functions are available, see PR:9.</p>	
<p>PR:8 - Type of regulation for air conditioning</p> <p>As PR:7 but FR5 used for convector fan and SL0 for underfloor cooling.</p>	
<p>PR:9 - Optimisation and anticipation</p> <p>This parameter allows you to activate an optimisation or anticipation function which is deactivated (OFF) by default.</p> <p>The optimisation function is only available with PID regulation, see PR:7 or PR:8 The anticipation function is available with on/off and PID regulation.</p> <p>Optimisation: the thermostat automatically estimates the time required to reach the Comfort temperature and adjusts the switch-on time of the heating so that the desired temperature is attained at the desired time. A period of around 10 days is necessary to train the installation because it depends on the type of inertia of your heating.</p> <p>Note: only P10 benefits from the optimisation function.</p> <ul style="list-style-type: none"> Press key ⑤ + to activate (AUT) the optimisation function. Confirm using the OK key to pass to the next parameter. <p>In reversible heating/air-conditioning mode (select HL for parameter PR:5); it is possible to select a different mode of regulation for each system.</p> <p>The heating may be configured as on/off and the air conditioning as PID regulated. In this case, the optimisation function and program P10 can only be applied during PID regulated air-conditioning.</p> <p>Anticipation: this function allows the Comfort or Comfort 2 temperature from the personalised program (P4) to be applied, in advance, for a configurable period of 1, 2 or 3 hours.</p> <p>Note: only P4R benefits from the anticipation function.</p> <ul style="list-style-type: none"> Press key ⑤ + to select the duration (1H, 2H ou 3H) of anticipation desired, (e.g. anticipation of 2 hours). Confirm using the OK key to pass to the next parameter. 	
<p>...</p>	

... cont.
PR:10 - Return to factory settings
This parameter lets you return programs and parameters to the factory settings. <ul style="list-style-type: none"> Press key 5 + or - to choose YES (reset) or NO (pas de reset). Confirm using the OK key to pass to the next parameter.
PR:12 - Software version
This parameter displays which version of the software is installed in the product. Press OK to exit from parameter adjustments.

- ON/OFF regulation: suitable for all types of installation (gas boiler with or without flue, fuel oil boiler, heat pump, heating/air-conditioning circulation).
- PID regulation: suitable for the following installations: heating or cooling circulation, gas boiler. The most accurate regulation.

To access the user parameters, press key **1** **menu** to place the cursor under **➡** and confirm using the **OK** key.

PR:1 - Default duration of the temporary override
This parameter allows you to input a default, restart time delay. Possible delay times are the following: 1 hour, 2 hours, 3 hours, 4 hours, 5 hours and 12 hours. The restart delay is set to 1 hour by default. <ul style="list-style-type: none"> Press key 5 + or - to modify the timed restart delay. Confirm using the OK key to pass to the next parameter.
PR:2 - Backlighting
Backlighting is activated (ON) by default. <ul style="list-style-type: none"> Press key 5 + or - to deactivate it (OFF). Confirm using the OK key to pass to the next parameter.
PR:3 - Temperature calibration
This parameter lets you adjust the value displayed by the thermostat if you measure a different ambient temperature to that which the thermostat measures. <ul style="list-style-type: none"> Press key 5 + or - to modify the temperature within a range of +/-3°C. Confirm using the OK key.
PR:4 - 2nd Comfort temperature level
This parameter allows you to choose one ☼ or two ☼☼ Comfort temperature levels. It is only applicable during programming of the free program (P4). <ul style="list-style-type: none"> Press key 5 + or - to choose 1 to 2. Confirm using the OK key to pass to the next parameter. Parameter PR:4 is set to 1, single Comfort level, by default.

Once adjustment of these 4 parameters is carried out, the thermostat switches to auto mode and registers these modifications.

Holiday mode

This mode protects your accommodation against the dangers of frost and maintains a minimum temperature during your absences, which can be adjusted between 5°C and 30°C.

You can program the duration of your absence to anticipate a rise in temperature for your return.

- Press key **2** **1**, and then press key **5** + to select the number of days absence (from 1 to 99 days).

The current day counts as 1.

Confirm using the **OK** key.

- The icon **☼** appears and the temperature to be adjusted flashes.
- Press key **5** + or - to indicate the desired temperature level. Confirm using the **OK** key. Leave the thermostat in this mode. To cancel and return to automatic mode, **1 menu**.
- To modify the duration of your absence or the temperature value, press key **2** **1** and proceed to the changes.

If the thermostat is in air conditioning mode, you can create 1 holiday programme and define the number of days absence. The air conditioning will stop. The ambient temperature will not be regulated.

Heating/Air-con reversibility

This function allows your installation to switch from Heating to Air conditioning mode.

It requires that parameter **PR:5** in **HL** in the menu **➡** (Heating/Air-con mode) is set beforehand.

- Press key **1** **menu** to place the cursor under **☼**.
- ☼** flashes and the thermostat regulates the heating.
- Press key **3** **☼** to change from Heating mode to Air conditioning mode.

☼ flashes and the thermostat regulates the air conditioning.

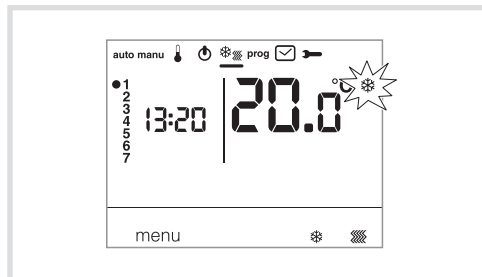

In **HL** mode, care should be taken to switch the HP suitably for the chosen thermostat mode.

Adjusting the temperature set-points

By default, the thermostat is in Heating mode (**H**) see **installer parameters PA:5 - Heating/Air-con mode**.

- If **PR:5** is set to heating only (**H**). The temperatures are preset: Comfort = 19°C, Comfort 2 = 20°C, Eco = 16°C. The adjustment range for the heating set-points is from 5°C to 30°C.
- If **PR:5** is set to air conditioning only (**L**). The temperatures are preset: Comfort = 24°C, Eco = 29°C. The range of adjustment for the air conditioning set points is from 20°C to 30°C.
- If **PR:5** is set to reversible heating/air conditioning (**HL**), you can modify the pre-set temperatures for each mode **☼** and **☼☼**.

Modification of the Comfort temperature

- Press key **1** **menu** to place the cursor under **☼**. The Comfort temperature **☼** flashes.
- Press key **5** + or - to modify the temperature. Confirm using the **OK** key.

Modification of the Comfort 2 temperature

- The Comfort temperature **☼☼** flashes.
- Press key **5** + or - to modify the temperature. Confirm using the **OK** key.

This adjustment is only available if the 2nd Comfort temperature level has been selected in the parameter menu **PR:4**.

Modification of the Eco temperature

- The Eco temperature **☼** flashes.
- Press key **5** + or - to modify the temperature. Confirm using the **OK** key.

Programming

Four programs are available to program your week : **P1**, **P2**, **P3**, , which are pre-recorded and not modifiable, and **P4** **P4** which is free and allows you to create a personalised program that can be different for each day of the week.

P1 is only available when the optimisation parameter is active (**PR:9**) and **P4** is only available when the anticipation parameter is active (**PR:9**). Your installer will perform the required parameterisation.

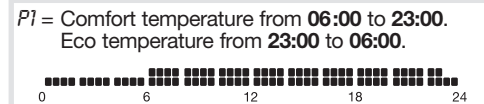

⚠ P1 is activated 7 days per week by default. If this fits the rhythm of your life then remain in automatic mode; if not, continue.

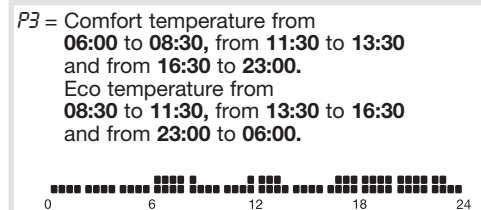
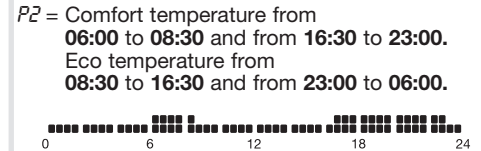
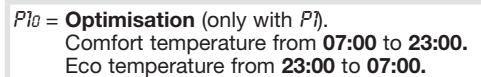

P4 = a free program which allows you to create up to 5 Comfort temperature periods and 5 Eco temperature periods, for each of the days of the week.

Assigning an existing program (P1, P2 or P3) to one or more days of the week

You can assign any of the programs to all 7 days of the week, to a group of five weekdays, to a group of two days for the weekend or to an individual day.

- Press key **1** **menu** to place the cursor under **prog**. The indicators for the seven days of the week flash.
- Press key **5** + to select which day, or group of days, to assign a program to. Confirm using the **OK** key.
- P1** flashes. Press key **5** + to select the program to apply. Confirm using the **OK** key.

As an example, to assign **P2** to the group of five weekdays and **P1** to the group of two weekend days:

- Press key **1** **menu** to place the cursor under **prog**. The indicators for the seven days of the



week flash.

- Press key ⑤ + to select to affect the group of five days (the group of five days flashes). Confirm using the OK key.
- P1 flashes. Press key ⑤ + to select P2 (P2 flashes). Confirm using the OK key.
- Press key ⑤ + to select the group of 2 weekend days (the group of 2 weekend days flashes). Confirm using the OK key.
- P1 flashes. Confirm using the OK key. The thermostat returns to **auto** mode.

Creation of a personalised program P4

This program allows you to adjust the heating to suit your way of life. A 24-hour profile is composed of 48 points (representing the set-points). You can visualise the composition of your program at the bottom of the display.

1 program step = 30 minutes.

		
30 min. in Eco	30 min. in Comfort	30 min. in Comfort 2

Example: creating a program, **P4** for a group of days (5 weekdays + 2 weekend days).

For the 5 weekdays, we would like 3 Comfort periods from 06:00 to 08:00, from 12:00 to 14:00 and from 18:00 to 22:00.

For the two weekend days, we would like a Comfort period from 08:00 to 19:00, then a Comfort 2 period from 19:30 to 22:00.

- Press key ① menu to place the cursor under **prog**. The indicators for the seven days of the week flash.
- Press key ⑤ + to select to affect the group of five days (the group of five days flashes). Confirm using the OK key.
- P1 flashes. Press key ⑤ + to select P4 (P4 flashes). Confirm using the OK key.
- Press key ① ☾ until 6:00 appears and then key ② ⚡ until 8:00 appears. Then press key ① ☾ until 12:00 and key ② ⚡ until 14:00. Then press key ① ☾ until 18:00 appears and finally key ② ⚡ until 22:00.

If you make an error, press key ⑤ - to move backwards or key ⑤ + to advance and correct your programming.

- Confirm using the OK key.
- The group of 2 weekend days flashes. Confirm using the OK key.
- P1 flashes. Press key ⑤ + to select P4 (P4 flashes). Confirm using the OK key.
- Press key ① ☾ until 8:00 appears and key ② ⚡ until 19:30 appears. Then press key ③ ⚡ until 22:00 and press key ① ☾ until 24:00. Confirm using the OK key.

Note:

The latest P4 program is held in memory and automatically offered to be assigned to a new day or group of days (whose P4 is empty).

Setting anticipation to 1 sends program P4 => P4A.

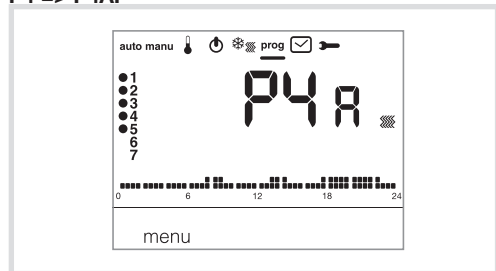

If the **anticipation** function (1H, 2H or 3H) in the **Installer parameters PA:9** has been confirmed, **P4A** is displayed in place of **P4**. during programming, proceed in the same way as for **P4** knowing that the thermostat will automatically apply the anticipation with the duration set in **PA:9**. it is not useful to foresee this anticipation time during your programming.

Temporary overrides

By overriding until the next program step, in **auto** mode, it is possible to modify the temperature of the current set-point.

- Press key ⑤ + or - to increase or reduce the temperature of the displayed set-point. The set-point temperature flashes and the override is valid until the next step of the program.
- During the override period, the current set-point temperature flashes.

Temporary override

In auto mode, this function allows temporary modification of the ambient temperature, at any time, whatever the instruction in progress. The range of duration of this function is from 15 minutes to 12 hours.

- Press key ③ ⏸, the duration adjusted in **PR:1** flashes
- Press key ⑤ + or - to adjust the desired duration. Confirm using the OK key.
- Press key ⑤ + or - to adjust the desired temperature. Confirm using the OK key.

The end time of the temporary override flashes on the bar chart of the screen and the value of the duration of the temporary override is displayed in place of the current time, until the return to **auto**-mode.

If a temporary override is in progress, it is possible to modify the temperature in steps of 0.5°C using key 0,5°C ⑤ + or -.

One press on key ③ ⏸ allows the delay time to be modified; the last selected duration is displayed

Accessories

Telephonic remote control

The thermostat is equipped with an input for telephonic commands for your heating. The symbol ☎ is displayed if the Frost protection mode is requested telephonically. Detection of telephonic remote commands is taken into account in less than 1 minute. You can modify the Frost protection temperature using the Holiday menu.

The temperature applied will be the last value confirmed in **Holiday** mode. In Air conditioning mode, during telephonic forcing the regulation is stopped.

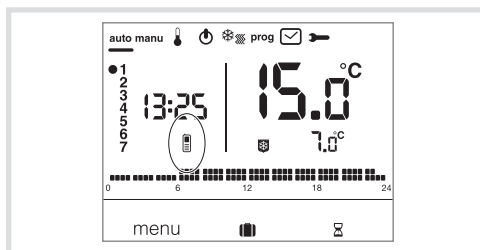

What to do if... ?

The symbol 🔋 is displayed:

change the batteries (2 alkaline batteries of type LR06 1.5 V) as soon as possible.

The symbol ☎ is displayed:

the thermostat is locked in Frost protection mode by telephonic remote control. Unlock the function by a telephone call or using the remote control.

The heating does not start up, even though the ambient temperature is less than the set point: function of the evolution of the ambient temperature over the last few hours.

The thermostat estimates that the temperature will be obtained without contributing additional energy. It does not request ignition of the generator. Ask your installer for confirmation.

The heating starts up even though the ambient temperature is greater than the set point temperature:

Your installer has selected a form of regulation known as PID which anticipates a drop in the ambient temperature as a function of its evolution over the last few hours. The thermostat estimates that the ambient temperature will be less than the setpoint temperature if it does not contribute additional energy. It requests ignition of the generator. Ask your installer for confirmation.

Technical characteristics

Power supply: 2 alkaline batteries 1,5V (type LR06)
 Battery lifespan: 4 years
 Static differential (On/Off regulation): < 0.3 °C
 Power reserve: 10 min
 Adjustment range
 - Comfort temperature: +5 °C to +30 °C
 - Comfort 2 temperature: +5 °C to +30 °C
 - Eco temperature: +5 °C to +30 °C
 Ambient temperature display range: 0°C to +40°C
 Operating temperature: +0 °C to +45 °C
 Storage temperature: -25 °C to +70 °C
 Ball test temperature: 75 °C and 125 °C
 Clock operating accuracy: drifts < 1sec/day
 Trip values: 230V ~ 5A resistive / 3A inductive
 Minimum load excepted by the relay: 12V / 10mA
 Relative humidity: 90 % at 20 °C
 IP: 30
 Ecodesign class: 4
 IK: 04
 Insulation class: II
 Insulation type: 4 kV
 Rigid cable cross-sections: 0, 5 to 2.5 mm²
 Flexible cable cross-sections: 0,5 to 1.5 mm²
 Minimum pulse voltage: 4 kV
 Pollution class: 3
 Action type: 2B
 Insulation type: reinforced insulation
 Software structure: class A
 Dimensions (l x h x d): 97 x 138 x 30
 Voltage and current declared for the needs of EMC emissions tests: 230V ~ 0,5A
 Upstream protection: circuit breaker 6A
 Independent installation device for built-in installation



Correct Disposal of This product (Waste Electrical & Electronic Equipment)

(Applicable in the European Union and other European countries with separate collection systems).

This marking shown on the product or its literature indicates that it should not be disposed with other household waste at the end of its working life. To prevent possible harm to the environment or human health from uncontrolled waste disposal, please separate this from other types of wastes and recycle it responsibly to promote the sustainable reuse of material resources. Household users should contact either the retailer where they purchased this product, or their local government office, for details of where and how they can take this item for environmentally safe recycling.

Business users should contact their supplier and check the terms and conditions of the purchase contract. This product should not be mixed with other commercial wastes of disposal.

Usable in all Europe  and in Switzerland