









application software



- ▲ Manufacturers
- ▲ Hager Electro
- ▲ Outputs
 - 2-outputs modules
 - 4-outputs modules
 - 6-outputs modules
 - 8-outputs modules
 - 10-outputs modules
 - 16-outputs modules
 - 20-outputs modules

2 - 4 - 6 - 8 - 10 - 16 - 20 switch actuator
Electrical/Mechanical characteristics: see product user manual

	Product reference	Product designation	Application software ref	TP device Radio device
	TXA604D	4-fold switch actuator 16A C-load 230V AC	STXA604D 1.x Version	
	TXA606B TXA606D	6-fold switch actuator 10A 230V AC 6-fold switch actuator 16A C-load 230V AC	STXA606x 1.x Version	
	TXA608B TXA608D	8-fold switch actuator 10A 230V AC 8-fold switch actuator 16A C-load 230V AC	STXA608x 1.x Version	
	TXA610B TXA610D	10-fold switch actuator 10A 230V AC 10-fold switch actuator 16A C-load 230V AC	STXA610x 1.x Version	
	TXM616D	16-fold switch actuator 16A C-load 230V AC	STXM616D 1.x Version	
	TXM620D	20-fold switch actuator 16A C-load 230V AC	STXM620D 1.x Version	
	TXB602F	2-fold switch actuator 10A 230V AC, embedded	STXB602F 1.x Version	

Content

1. General	4
1.1 About this guide	4
1.2 About the program ETS	4
1.2.1 ETS compatibility	4
1.2.2 Application descriptions	4
2. General Description	5
2.1 Installation of the device	5
2.1.1 Overview presentation	5
2.1.2 Description of the device	6
2.1.3 Physical addressing	7
2.1.4 Connection	7
2.2 Function modules of the application	8
2.2.1 ON/OFF	8
2.2.2 Shutter/blind	10
3. Programming by ETS	12
3.1 Parameters	12
3.1.1 Closing type for the outputs	12
3.1.2 Fixed parameters	13
3.1.2.1 General	13
3.1.2.2 ON/OFF	13
3.1.2.3 Shutter/blind	13
3.1.3 Functions of each switch actuator	14
3.1.3.1 Timer	14
3.1.3.2 Priority	15
3.1.3.4 Load shedding	18
3.1.3.3 Automatic control	16
3.1.3.5 Scene	19
3.1.4 Functions for each shutter/blind output	22
3.1.4.1 Function selection	24
3.1.4.2 Status indication	26
3.1.4.4 Priority	29
3.1.4.3 Alarm	27
3.1.4.5 Automatic control	30
3.1.4.6 Scene	32
3.2 Communication objects	35
3.2.1 Output communication objects ON/OFF	35
3.2.1.1 ON/OFF	38
3.2.1.2 Status indication	38
3.2.1.3 Timer	38
3.2.1.4 Priority	39
3.2.1.5 Scene	40
3.2.1.6 ON/OFF automatic control	40
3.2.1.7 Automatic control deactivation	41
3.2.1.8 Load shedding	41
3.2.2 Communication objects for each shutter/blind output	42
3.2.2.1 Control	44
3.2.2.2 Status indication	46
3.2.2.3 Priority	47
3.2.2.4 Scene	48
3.2.2.5 Alarm	48
3.2.2.6 Position in % automatic control	49
3.2.2.7 Slat angle in % automatic control	49
3.2.2.8 Automatic control deactivation	50
4. Programming by Easy Tool	51
4.1 Product overview	51
4.2 Closing type for the outputs	55
4.3 Product functionalities	56
4.3.1 Functions of each switch actuator	56
4.3.1.1 ON/OFF	56
4.3.1.2 Timer	58
4.3.1.3 Priority	60
4.3.1.4 Automatic control	62
4.3.1.5 Load shedding	64
4.3.1.6 Scene	65
4.3.2 Functions for each shutter/blind output	68
4.3.2.1 Pathway parameters	70
4.3.2.2 Up/down	71
4.3.2.3 Shutter or blind angle	73
4.3.2.4 Priority	76

4.3.2.5 Alarm	78
4.3.2.6 Automatic control	81
4.3.2.7 Scene.....	85
5. Appendix	88
5.1 Specifications	88
5.2 Characteristics.....	92
5.3 Index of objects	92
5.3.1 ON/OFF.....	92
5.3.2 Shutter/blind	92

1. General

1.1 About this guide

The purpose of this manual is to describe the operation and configuration of KNX devices using ETS software or Easy tool software.

It consists of 4 parts:

- General information.
- The parameters and KNX objects available.
- The Easy tool configurations are available.
- Technical characteristics.

1.2 About the program ETS

1.2.1 ETS compatibility

The application programs are compatible with ETS4 and ETS5. They can be downloaded from our website under the order number.

ETS Version	File extension of compatible files
ETS4 (V4.1.8 or higher)	*.knxprod
ETS5	*.knxprod

1.2.2 Application descriptions

Application	Product reference
STXA604D	TXA604D
STXA606x	TYA606B/D
STXA608x	TYA608B/D
STXA610x	TYA610B/D
STXM616D	TXM616D
STXM620D	TXM620D
STXB602F	TXB602F

1.3 Easy tool software appearance

This product can also be configured using the TXA100 configuration tool. It is composed of a TJA665 configuration server. It is essential to update the configuration server software version. (Please refer to the TXA100 user manual).

2. General Description

2.1 Installation of the device

2.1.1 Overview presentation

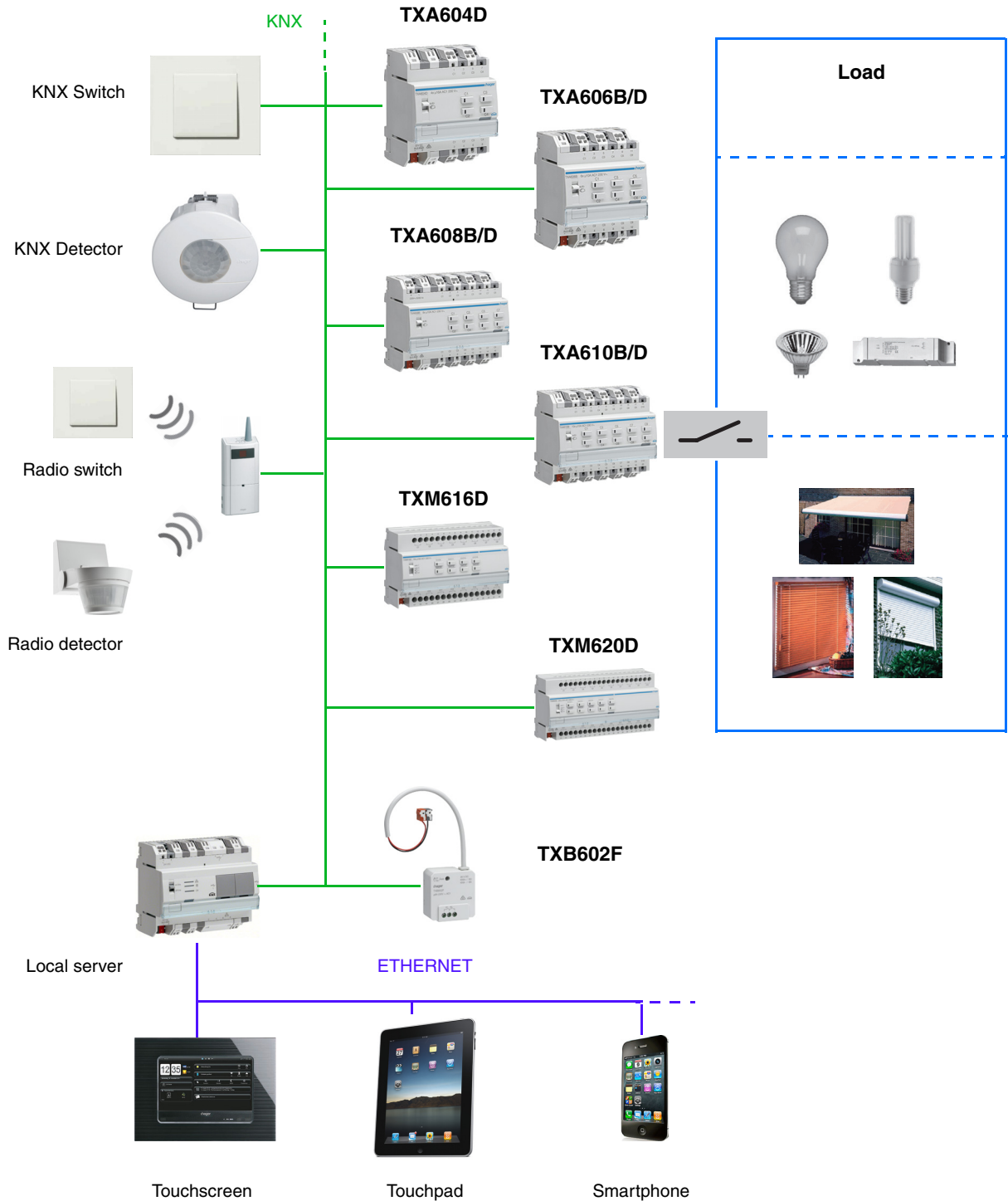

2.1.2 Description of the device

- TXB602F

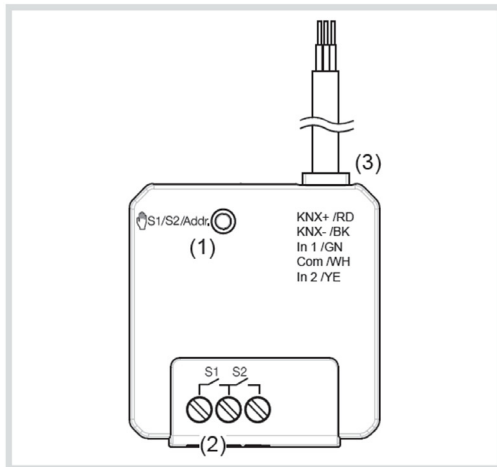

- (1) Illuminated button for manual operation/programming button
- (2) Connection of load(s)
- (3) KNX bus connection cable/connection inputs

- TXA6..B/D

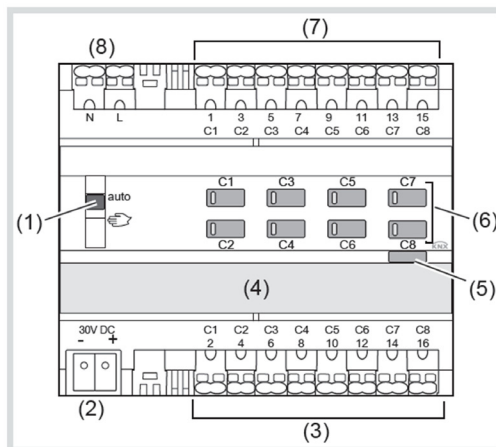

- (1) Slide switch **auto** /
- (2) KNX bus connection terminal
- (3) Connections loads
- (4) Labelling field
- (5) Illuminated programming button
- (6) Operation button for manual operation per output with status LED
- (7) Connections for switching voltage
- (8) Mains power supply connections (only 8gang)

i With variants 4/2gang, 6/3gang and 10/5gang the basic design corresponds to the 8/4gang device variant.

- TXM6..D

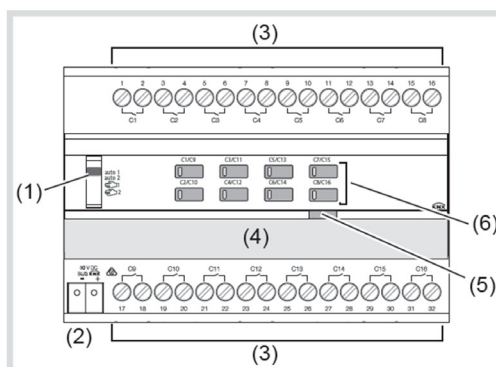

- (1) Slide switch **auto1/auto2** / /
- (2) KNX bus connection terminal
- (3) Connections of loads
- (4) Labelling field
- (5) Illuminated programming button
- (6) Operation button for manual operation for each pair of outputs with status LED

i With variants 20/10gang the basic design corresponds to the 16/8gang device variant.

auto1	Used to view outputs 1 to 8 (1 to 10) via the status LEDs.
auto2	Used to view outputs 9 to 16 (11 to 20) via the status LEDs.
	Used to control outputs 1 to 8 (1 to 10) via the manual control buttons.
	Used to control outputs 9 to 16 (11 to 20) via the manual control buttons.

2.1.3 Physical addressing

In order to perform the physical addressing or to check whether or not the bus is connected, press the lighted push button (see chapter 2.1.2 for the button location).

Light on = bus connected and ready for physical addressing.

Programming mode is activated, until the physical address is transferred from ETS. Pressing the button again, exits programming mode. Physical addressing can be carried out in automatic or manual mode.

2.1.4 Connection

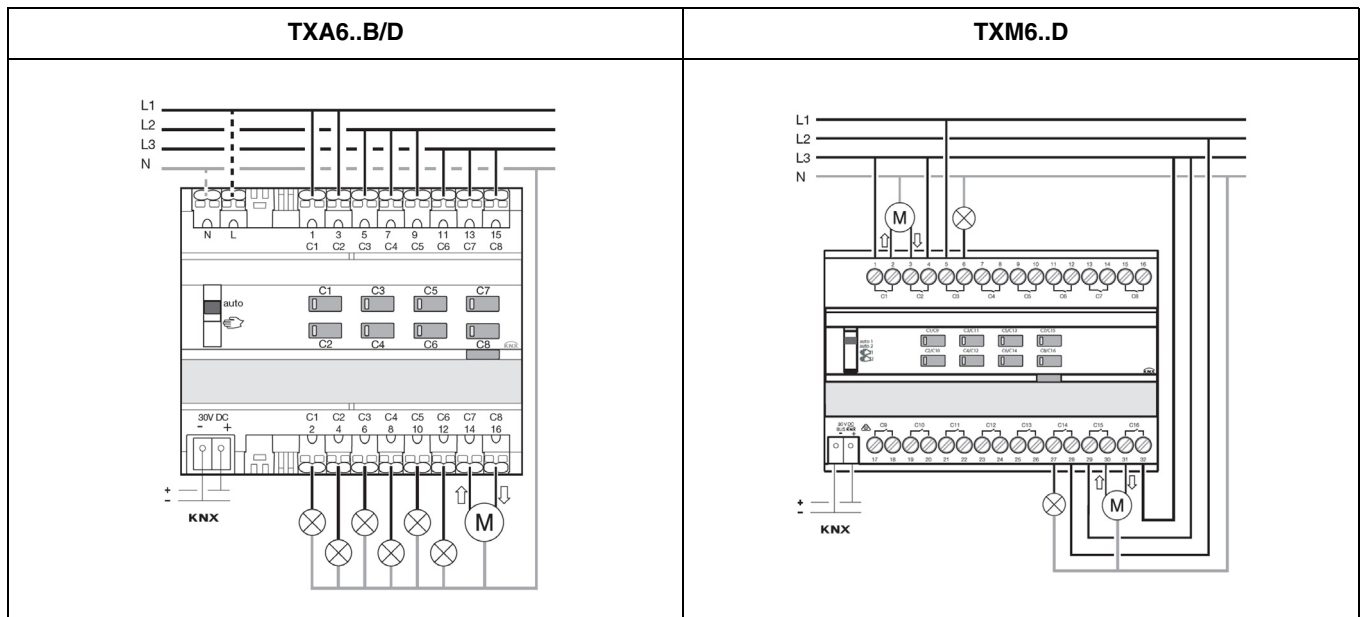
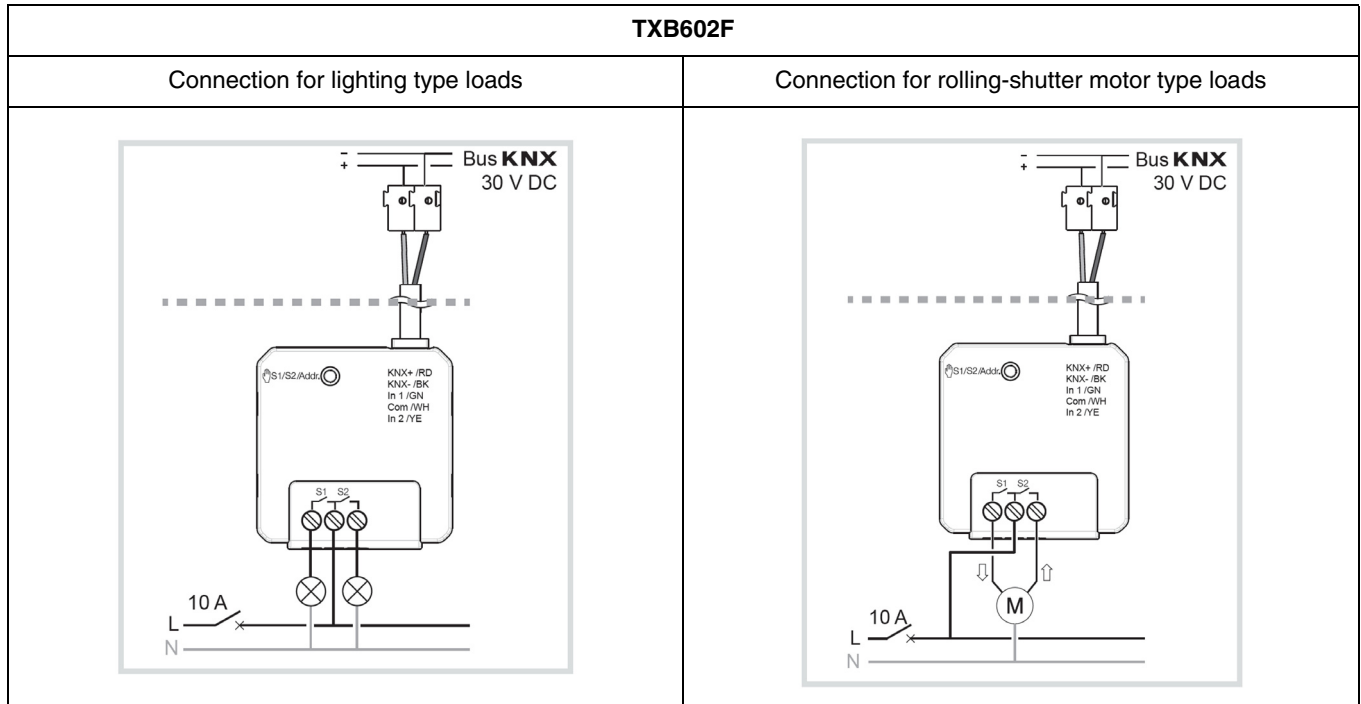

2.2 Function modules of the application

The switch actuators of the devices can be used in 2 different modes.

ON/OFF

- Each switching contact is used separately to switch a load.

Shutter/blind

- Each pair of outputs constitutes a shutter and blind channel.

A mix of the two operating modes is possible.



Warning: The devices are delivered in ON/OFF operating mode. When connecting shutters or blinds, ensure that both contacts are not turned on at the same time!

2.2.1 ON/OFF

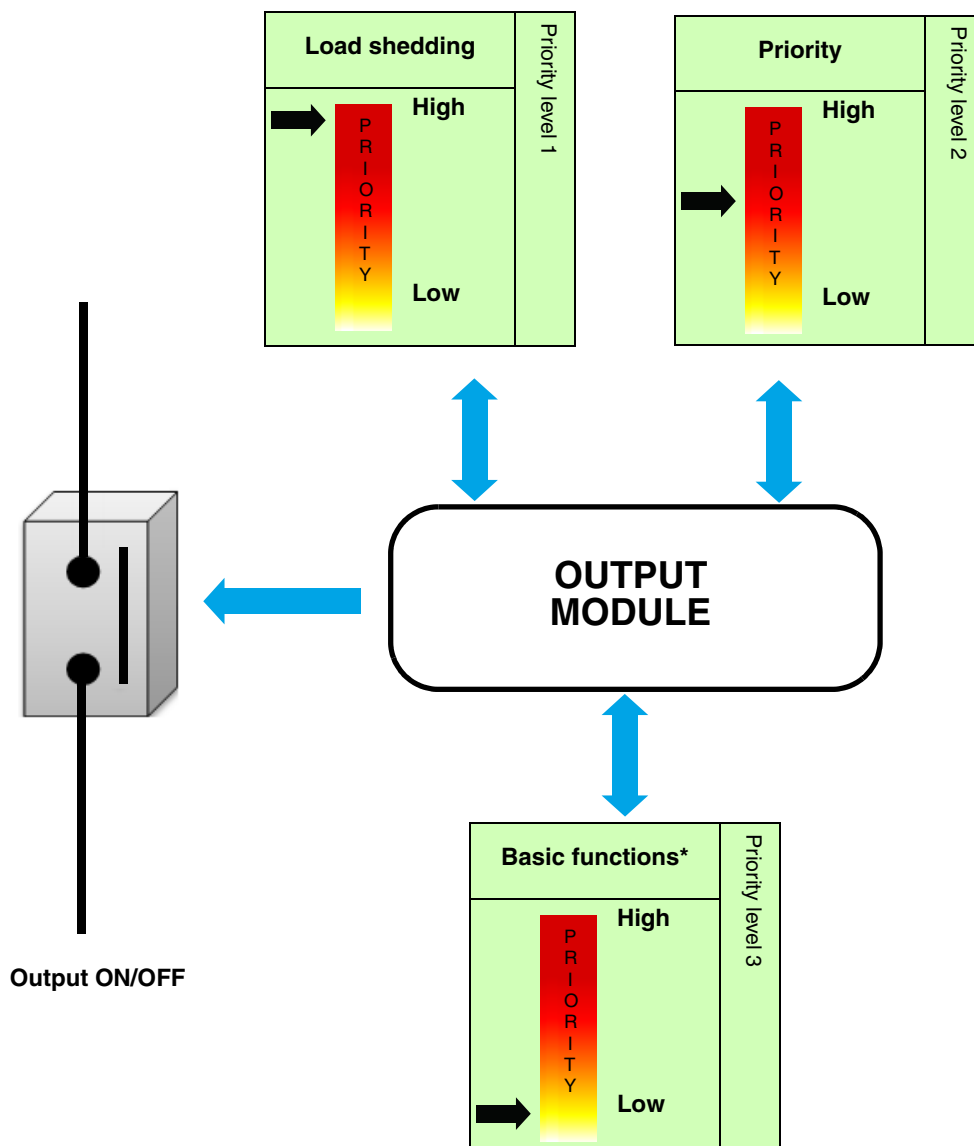

* ON/OFF - Timer - Scene: The last command received will have priority.

The applications allow individual configuration of the device outputs. The most important functions are:

■ **ON/OFF**

An output can be switched on or off using the ON/OFF function. The command can come from switches, buttons or other control inputs.

■ **Timer**

The Timer function is used to switch an output on for a programmable period. A programmable Cut-OFF pre-warning announces the end of the delay time by a 1-second inversion of the output status. The timer duration can be modified via the bus KNX.

■ **Priority**

The Priority function is used to force the output into a defined state. The Priority function is controlled with a 2-bit command.

Priority: Load shedding > **Priority** > Basic function.

Application: Keeping lighting on for security reasons.

■ **Automatic control**

The Automatic control function is used to command an output in parallel to the ON/OFF function. The two functions have the same level of priority. The last command received will act on the status of the output.

An additional command object is used to activate or deactivate the Automatic control.

■ **Load shedding**

The Load shedding function is used to force an output to OFF. Load shedding is activated by receipt of a 1-byte command.

Priority: **Load shedding** > Priority > Basic function.

This command has the highest priority. No other command is taken into account if the mode is active. The status of the output is memorised but not applied. At the end of load shedding, the output is switched to the theoretical status without Load shedding (memorisation).

■ **Scene**

The Scene function is used to switch groups of outputs into a configurable predefined state. Pressing a push button activates a scene.

A scene is activated by receipt of a 1-byte command.

Each output can be included in 64 different scenes.

■ **Manual mode**

Manual mode allows the device to be disconnected from the bus. In this mode, each output can be priority controlled locally.

Note: Manual mode is not available with the 2 ON/OFF outputs module (TXB602F).

■ **Status indication**

The Status indication sends the switching status of the individual output contact on the KNX bus.

Communication objects

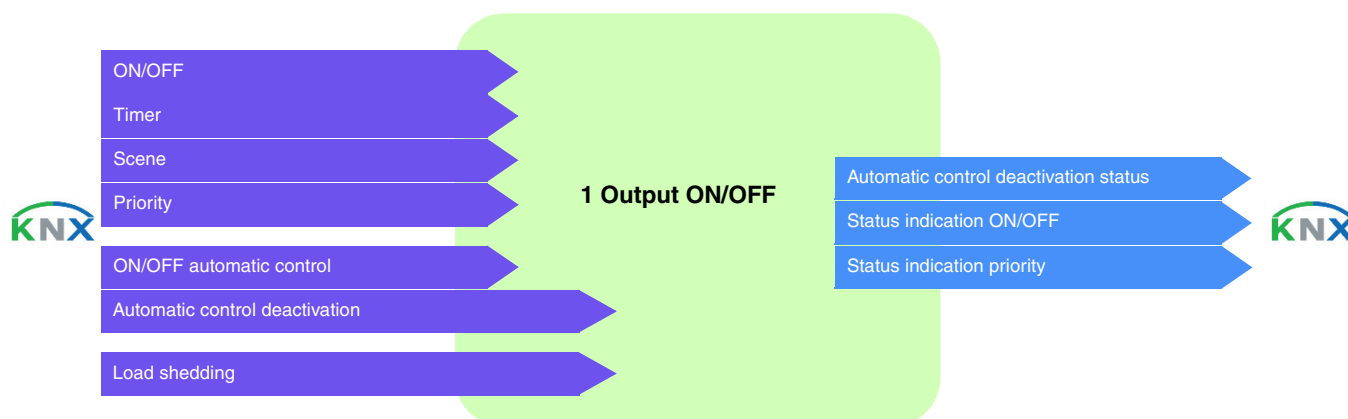

2.2.2 Shutter/blind

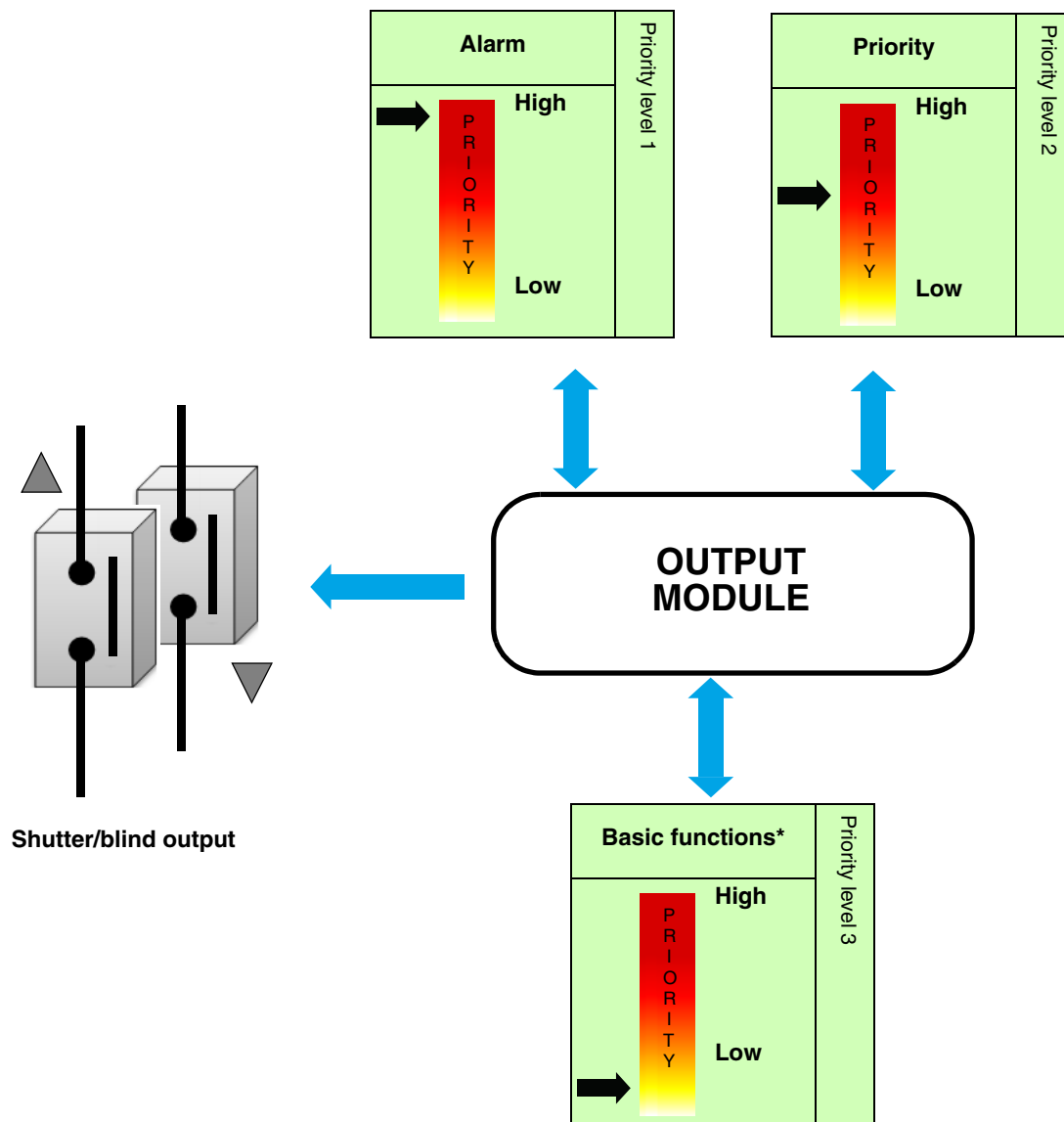

* Up/down - Step/stop control - Position in % - Slat angle (0-100%) - Scene: The last command received will have priority.

The applications allow individual configuration of the device outputs. The most important functions are:

■ Up/down

The UP/DOWN function is used to run up or down shutters, blinds, awnings, etc.
This function can also be used to open and close electric blinds.
The command can be given by touch sensors (long press), switches or automatically.

■ Slat position/Stop

The Slat position/Stop function is used to adjust the slats of a blind or to stop its ongoing movement. This function can be used to alter the shade and the incidence of light from outside.
The control command may be issued by a push button, for example: A short press on UP/DOWN buttons.

■ Stop

The Stop function is used to stop the movement of a shutter or blind. For a blind, this function does not alter the tilt of the slats.

■ Scene

The Scene function is used to switch groups of outputs into a configurable predefined state. Pressing a push button activates a scene. A scene is activated by receipt of a 1-byte command. Each output can be included in 64 different scenes.

■ Priority

The Priority function is used to force the output into a defined state.

Priority: Alarm > **Priority** > Basic function.

Application: Maintaining a hanging position for security reasons.

■ Alarm

With the Alarm function a shutter or blind can be positioned in a configurable predefined state.

Priority: **Alarm** > Priority > Basic function.

Up to 3 alarm functions are possible (Alarm 1 - Alarm 2 - Alarm 3).

The alarm prevents any actuation until an alarm cancellation command has been received.

■ Automatic control

The Automatic control function is used to control an output in parallel to the Up/Down or Slat tilt/stop function.

The functions have the same level of priority. The last command received will act on the status of the output.

An additional command object is used to activate or deactivate the Automatic control.

■ Manual mode

Manual mode allows the device to be disconnected from the bus. In this mode, each output can be priority controlled locally.

Note: Manual mode is not available with the 2 ON/OFF outputs module (TXB602F).

■ Status indication

Using the Status indication function, the following can be sent via the bus:

- Position in % indication: Indicates the position of the shutter or blind.
- Indication of slat position in %: Indicates the slat pitch of the blind.
- Upper or lower position reached: Indicates arrival at the upper or lower position.

Communication objects

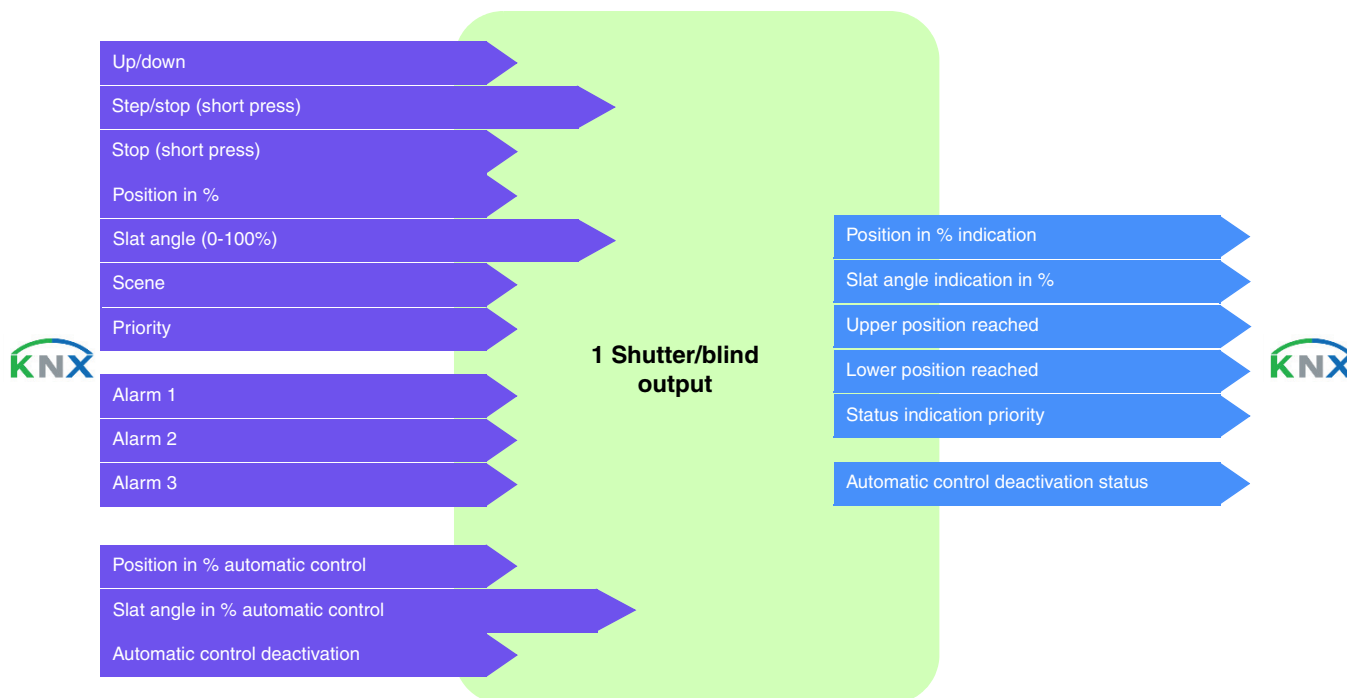

3. Programming by ETS

The function of the different devices only differs in the number of outputs. For this reason, only one device or one output will ever be described.

3.1 Parameters

3.1.1 Closing type for the outputs

This configuration window is used to set the Closing type for the outputs. The following parameters are available:

ON/OFF

- Each switching contact is used separately to switch a load.

Shutter/blind

- Each pair of outputs constitutes a shutter and blind channel.

Outputs 1-10: Function		
Function O1-O2	<input checked="" type="radio"/> ON/OFF	<input type="radio"/> Shutter and blind
Function O3-O4	<input checked="" type="radio"/> ON/OFF	<input type="radio"/> Shutter and blind
Function O5-O6	<input checked="" type="radio"/> ON/OFF	<input type="radio"/> Shutter and blind
Function O7-O8	<input checked="" type="radio"/> ON/OFF	<input type="radio"/> Shutter and blind
Function O9-O10	<input checked="" type="radio"/> ON/OFF	<input type="radio"/> Shutter and blind
Outputs 1-10: Fixed parameters		
+ Output 1		
+ Output 2		
+ Output 3		
+ Output 4		
+ Output 5		
+ Output 6		
+ Output 7		
+ Output 8		
+ Output 9		
+ Output 10		
+ Information		

Parameter	Description	Value
Function Ox-Oy	The outputs are used as ON/OFF switches. The outputs are used for shutters and blinds. One output for raising and one output for lowering.	ON/OFF* Shutter and blind

The assignment of the outputs is carried out following:

	ON/OFF	Shutter and blind
Function O1-O2	Output 1: ON/OFF Output 2: ON/OFF	Output 1-2: Shutter and blind
Function O3-O4	Output 3: ON/OFF Output 4: ON/OFF	Output 3-4: Shutter and blind
Function O5-O6	Output 5: ON/OFF Output 6: ON/OFF	Output 5-6: Shutter and blind
Function O7-O8	Output 7: ON/OFF Output 8: ON/OFF	Output 7-8: Shutter and blind
Function O9-O10	Output 9: ON/OFF Output 10: ON/OFF	Output 9-10: Shutter and blind

* Default value

3.1.2 Fixed parameters

The fixed parameters define the operating mode of the output relays.

3.1.2.1 General

Parameter	Description	Value
Output contact	On receipt of an ON command: The output relay closes.	Normally open
Parameters overwrite at next download (scenes)	The parameter values stored in the device will be overwritten with the ETS configured values at the next download.	Active
Status after priority	At the end of the priority, the output is: Switched back to the status before priority was activated.	Status before priority

3.1.2.2 ON/OFF

Parameter	Description	Value
Status after ETS download	The output status remains unchanged after ETS download. <i>Note: During ETS-parameters download, the outputs remain unchanged.</i>	Maintain status
Status after bus power cut	The output status remains unchanged during at bus return. <i>Note: The device will reboot on bus return. The priority functions that were present before the bus power cut are no longer active (Load shedding, Priority).</i>	Maintain status

3.1.2.3 Shutter/blind

Parameter	Description	Value
Status after ETS download	Maintain the position before download. <i>Note: During ETS-parameters download, the outputs remain unchanged.</i>	Maintain status
Status after bus power cut	Maintain the position before the bus power cut. <i>Note: The device will reboot on bus return. The priority functions that were present before the bus power cut are no longer active (Alarm, Priority).</i>	Maintain status
Position after alarm	Runs to the position which would be active according to other communication objects if the alarm had not taken place.	Theoretical status without alarm

3.1.3 Functions of each switch actuator

3.1.3.1 Timer

The Timer function is used to switch on a lighting circuit for a programmable period. The timer may be interrupted before expiry of the delay time. A programmable Cut-OFF pre-warning announces the end of the delay time by a 1-second inversion of the output status.

Timer	<input checked="" type="checkbox"/>
Timer duration	2 min
Cut-OFF pre-warning	30 s

Parameter	Description	Value
Timer duration	This parameter determines the timer duration.	Not active, 1 s, 2 s, 3 s, 5 s, 10 s, 15 s, 20 s, 30 s, 45 s, 1 min, 1 min 15 s, 1 min 30 s, 2 min* , 2 min 30 s, 3 min, 5 min, 15 min, 20 min, 30 min, 1 h, 2 h, 3 h, 5 h, 12 h, 24 h

Parameter	Description	Value
Cut-OFF pre-warning	This parameter determines the lead time of the cut-OFF pre-warning.	Not active, 15 s, 30 s* , 1 min

Operating principle:

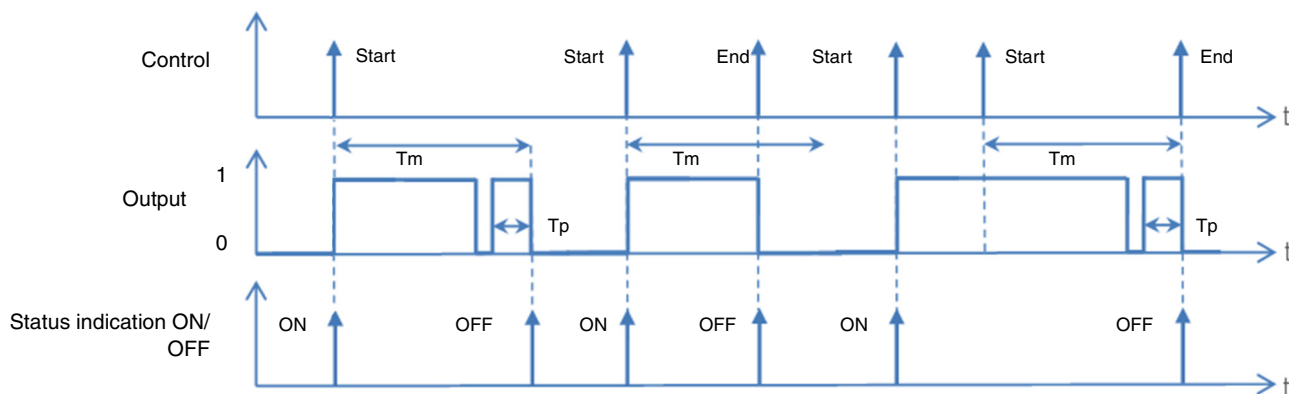

T_m : Timer duration
 T_p : Pre-warning lead time

Note: If the lead time of the cut-OFF pre-warning is greater than the duration of the timer, the cut-OFF pre-warning is not triggered.

* Default value

- Communication objects:
- 2 - Output 1 - Timer (1 Bit – 1.001 DPT_Switch)
 - 12 - Output 2 - Timer (1 Bit – 1.001 DPT_Switch)
 - 22 - Output 3 - Timer (1 Bit – 1.001 DPT_Switch)
 - 32 - Output 4 - Timer (1 Bit – 1.001 DPT_Switch)
 - 42 - Output 5 - Timer (1 Bit – 1.001 DPT_Switch)
 - 52 - Output 6 - Timer (1 Bit – 1.001 DPT_Switch)
 - 62 - Output 7 - Timer (1 Bit – 1.001 DPT_Switch)
 - 72 - Output 8 - Timer (1 Bit – 1.001 DPT_Switch)
 - 82 - Output 9 - Timer (1 Bit – 1.001 DPT_Switch)
 - 92 - Output 10 - Timer (1 Bit – 1.001 DPT_Switch)

3.1.3.2 Priority

The Priority function is used to force the output into a defined state.

Priority: Load shedding > **Priority** > Basic function.

At the end of the priority, the output returns to the status it had before the priority (Memorisation function).

The device responds to telegrams received via the **Priority** object, as given in the following table:

Telegram received by the priority operation object			Output behaviour
Hexadecimal Value	Binary Value		
	Bit 1 (MSB)	Bit 0 (LSB)	
00	0	0	End of the priority
01	0	1	End of the priority
02	1	0	Priority OFF
03	1	1	Priority ON

Operating principle:

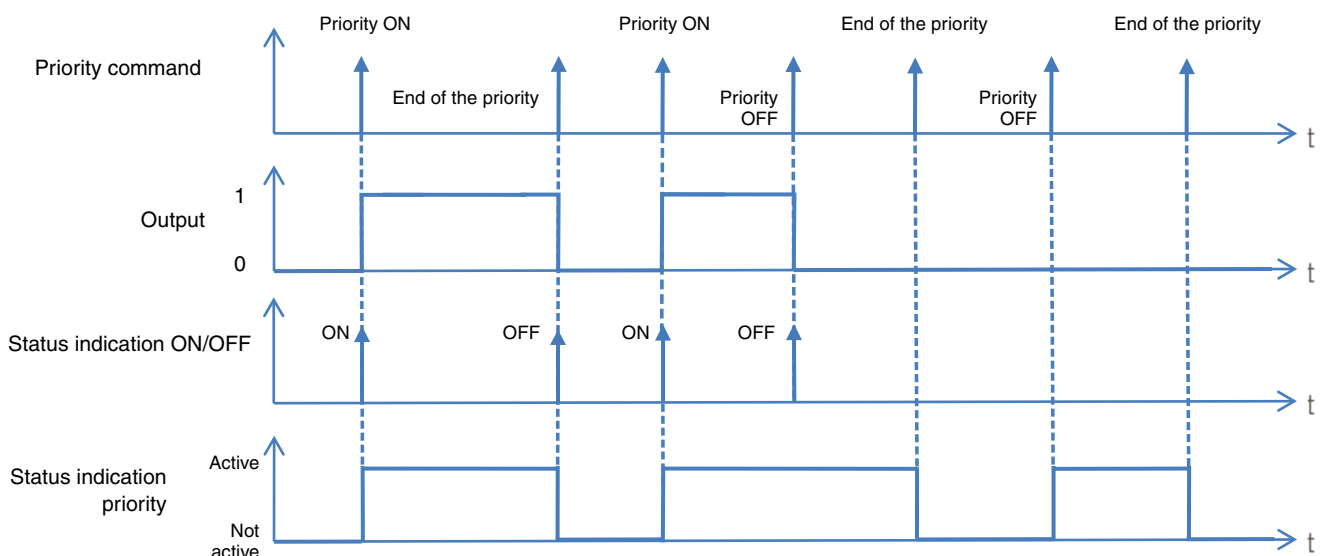

Communication objects:

- 3 - Output 1 - Priority (2 Bit – 2.002 DPT_Bool_Control)
- 13 - Output 2 - Priority (2 Bit – 2.002 DPT_Bool_Control)
- 23 - Output 3 - Priority (2 Bit – 2.002 DPT_Bool_Control)
- 33 - Output 4 - Priority (2 Bit – 2.002 DPT_Bool_Control)
- 43 - Output 5 - Priority (2 Bit – 2.002 DPT_Bool_Control)
- 53 - Output 6 - Priority (2 Bit – 2.002 DPT_Bool_Control)
- 63 - Output 7 - Priority (2 Bit – 2.002 DPT_Bool_Control)
- 73 - Output 8 - Priority (2 Bit – 2.002 DPT_Bool_Control)
- 83 - Output 9 - Priority (2 Bit – 2.002 DPT_Bool_Control)
- 93 - Output 10 - Priority (2 Bit – 2.002 DPT_Bool_Control)
- 4 - Output 1 - Status indication priority (1 Bit – 1.011 DPT_State)
- 14 - Output 2 - Status indication priority (1 Bit – 1.011 DPT_State)
- 24 - Output 3 - Status indication priority (1 Bit – 1.011 DPT_State)
- 34 - Output 4 - Status indication priority (1 Bit – 1.011 DPT_State)
- 44 - Output 5 - Status indication priority (1 Bit – 1.011 DPT_State)
- 54 - Output 6 - Status indication priority (1 Bit – 1.011 DPT_State)
- 64 - Output 7 - Status indication priority (1 Bit – 1.011 DPT_State)
- 74 - Output 8 - Status indication priority (1 Bit – 1.011 DPT_State)
- 84 - Output 9 - Status indication priority (1 Bit – 1.011 DPT_State)
- 94 - Output 10 - Status indication priority (1 Bit – 1.011 DPT_State)

3.1.3.3 Automatic control

The Automatic control function is used to command an output in parallel to the ON/OFF function. The two functions have the same level of priority. The last command received will act on the status of the output. An additional command object is used to activate or deactivate the Automatic control.

Example: when an output is controlled by a button and in parallel by an automatic control (timer, twilight switch, weather station, etc.) the automatic control can be deactivated for reasons of comfort (vacations, public holidays, etc.).

Automatic control	<input checked="" type="checkbox"/>
Automatic control deactivation	<input checked="" type="checkbox"/>

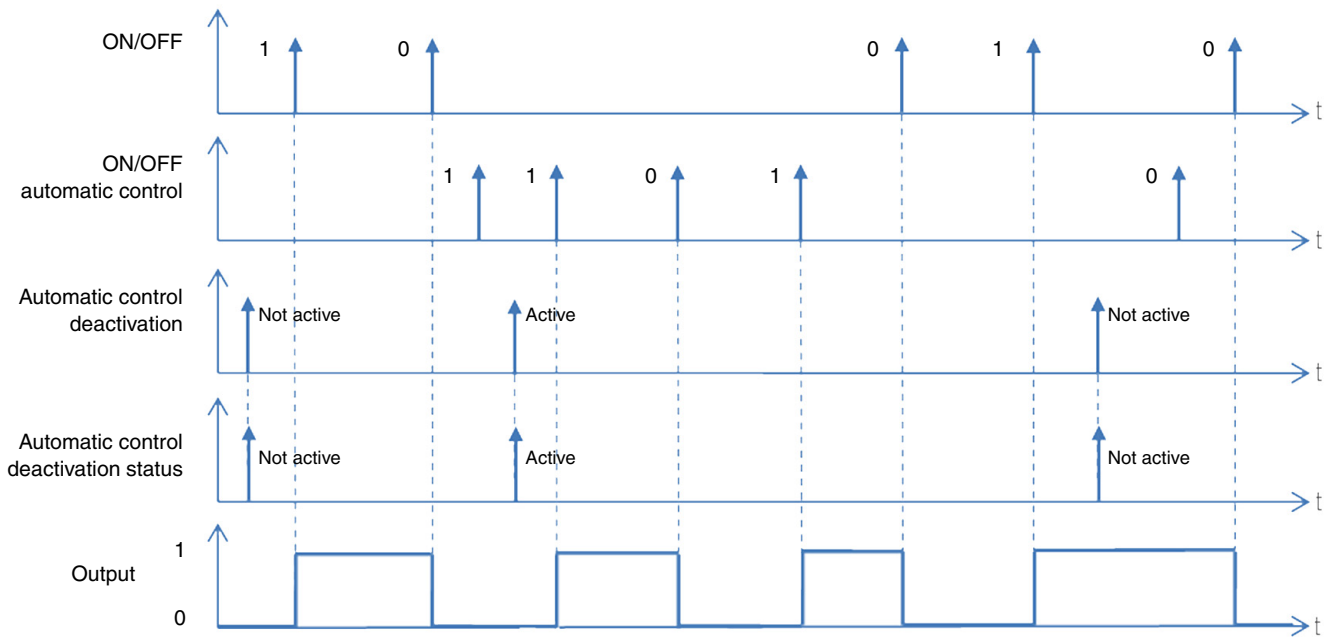

Communication objects:

- 6 - Output 1 - ON/OFF Automatic control (1 Bit – 1.001 DPT_Switch)**
- 16 - Output 2 - ON/OFF Automatic control (1 Bit – 1.001 DPT_Switch)**
- 26 - Output 3 - ON/OFF Automatic control (1 Bit – 1.001 DPT_Switch)**
- 36 - Output 4 - ON/OFF Automatic control (1 Bit – 1.001 DPT_Switch)**
- 46 - Output 5 - ON/OFF Automatic control (1 Bit – 1.001 DPT_Switch)**
- 56 - Output 6 - ON/OFF Automatic control (1 Bit – 1.001 DPT_Switch)**
- 66 - Output 7 - ON/OFF Automatic control (1 Bit – 1.001 DPT_Switch)**
- 76 - Output 8 - ON/OFF Automatic control (1 Bit – 1.001 DPT_Switch)**
- 86 - Output 9 - ON/OFF Automatic control (1 Bit – 1.001 DPT_Switch)**
- 96 - Output 10 - ON/OFF Automatic control (1 Bit – 1.001 DPT_Switch)**

Communication objects:

- 7 - Output 1 - Automatic control deactivation (1 Bit – 1.001 DPT_Switch)**
- 17 - Output 2 - Automatic control deactivation (1 Bit – 1.001 DPT_Switch)**
- 27 - Output 3 - Automatic control deactivation (1 Bit – 1.001 DPT_Switch)**
- 37 - Output 4 - Automatic control deactivation (1 Bit – 1.001 DPT_Switch)**
- 47 - Output 5 - Automatic control deactivation (1 Bit – 1.001 DPT_Switch)**
- 57 - Output 6 - Automatic control deactivation (1 Bit – 1.001 DPT_Switch)**
- 67 - Output 7 - Automatic control deactivation (1 Bit – 1.001 DPT_Switch)**
- 77 - Output 8 - Automatic control deactivation (1 Bit – 1.001 DPT_Switch)**
- 87 - Output 9 - Automatic control deactivation (1 Bit – 1.001 DPT_Switch)**
- 97 - Output 10 - Automatic control deactivation (1 Bit – 1.001 DPT_Switch)**

- Communication objects:
- 8 - Output 1 - Automatic control deactivation status (1 Bit – 1.001 DPT_Switch)
 - 18 - Output 2 - Automatic control deactivation status (1 Bit – 1.001 DPT_Switch)
 - 28 - Output 3 - Automatic control deactivation status (1 Bit – 1.001 DPT_Switch)
 - 38 - Output 4 - Automatic control deactivation status (1 Bit – 1.001 DPT_Switch)
 - 48 - Output 5 - Automatic control deactivation status (1 Bit – 1.001 DPT_Switch)
 - 58 - Output 6 - Automatic control deactivation status (1 Bit – 1.001 DPT_Switch)
 - 68 - Output 7 - Automatic control deactivation status (1 Bit – 1.001 DPT_Switch)
 - 78 - Output 8 - Automatic control deactivation status (1 Bit – 1.001 DPT_Switch)
 - 88 - Output 9 - Automatic control deactivation status (1 Bit – 1.001 DPT_Switch)
 - 98 - Output 10 - Automatic control deactivation status (1 Bit – 1.001 DPT_Switch)

3.1.3.4 Load shedding

The Load shedding function is used to force an output to OFF. Load shedding is activated by receipt of a 1-byte command. Priority: **Load shedding** > Priority > Basic function.

This command has the highest priority. No other command is taken into account if the mode is active. The status of the output is memorised but not applied. At the end of load shedding, the output is switched to the theoretical status without Load shedding (memorisation).

Example: Load shedding function

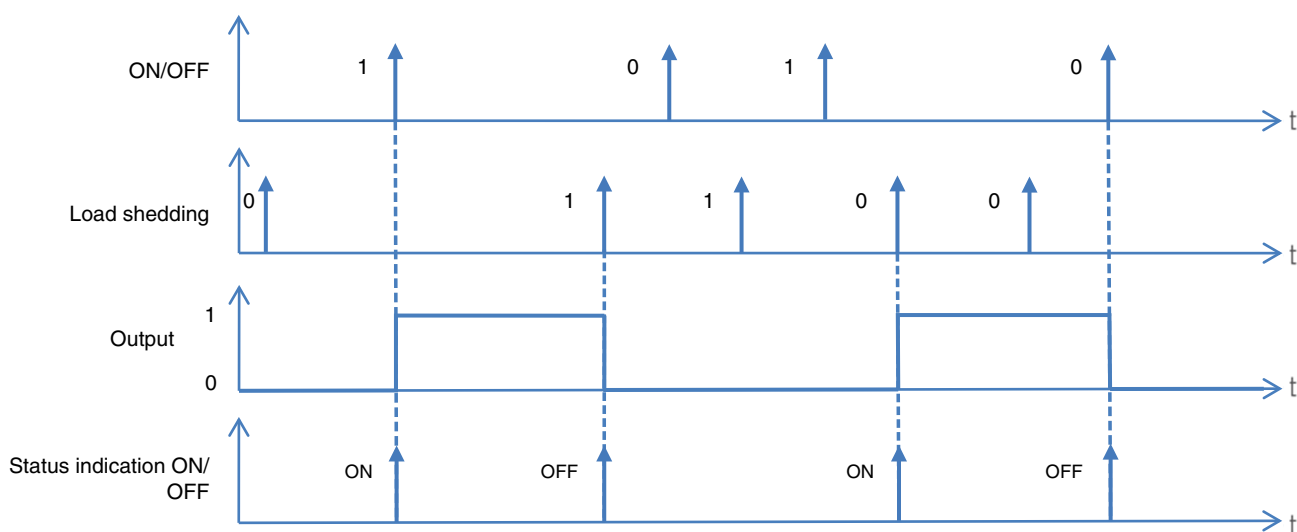

- Communication objects:
- 9 - Output 1 - Load shedding (1 Bit – 1.001 DPT_Switch)
 - 19 - Output 2 - Load shedding (1 Bit – 1.001 DPT_Switch)
 - 29 - Output 3 - Load shedding (1 Bit – 1.001 DPT_Switch)
 - 39 - Output 4 - Load shedding (1 Bit – 1.001 DPT_Switch)
 - 49 - Output 5 - Load shedding (1 Bit – 1.001 DPT_Switch)
 - 59 - Output 6 - Load shedding (1 Bit – 1.001 DPT_Switch)
 - 69 - Output 7 - Load shedding (1 Bit – 1.001 DPT_Switch)
 - 79 - Output 8 - Load shedding (1 Bit – 1.001 DPT_Switch)
 - 89 - Output 9 - Load shedding (1 Bit – 1.001 DPT_Switch)
 - 99 - Output 10 - Load shedding (1 Bit – 1.001 DPT_Switch)

3.1.3.5 Scene

Scene	<input checked="" type="checkbox"/>
Number of scenes used	8
Scene 1	<input checked="" type="checkbox"/>
Output status for scene 1	<input type="radio"/> OFF <input checked="" type="radio"/> ON
Scene 2	<input type="checkbox"/>
Scene 3	<input type="checkbox"/>
Scene 4	<input type="checkbox"/>
Scene 5	<input type="checkbox"/>
Scene 6	<input type="checkbox"/>
Scene 7	<input type="checkbox"/>
Scene 8	<input type="checkbox"/>

Parameter	Description	Value
Number of scenes used	This parameter determines the number of scenes used.	8* - 16 - 24 - 32 - 48 - 64

Note: If the Scene number received on the Scene object is greater than the maximum number of scenes, the status of the output remains unchanged.

Parameter	Description
Active Scene X	This parameter is used to activate the scene in question.

Parameter	Description	Value
Output status for scene X	On activation of Scene X, the output is: Selectively switched on. Selectively switched off.	ON* OFF

X = 1 to 64

*Note: Each output has up to 64 scenes available, in accordance with the **Number of scenes used** parameter.*

* Default value

Communication objects:

- 5 - Output 1 - Scene (1 Byte – 17.001 DPT_SceneNumber)
- 15 - Output 2 - Scene (1 Byte – 17.001 DPT_SceneNumber)
- 25 - Output 3 - Scene (1 Byte – 17.001 DPT_SceneNumber)
- 35 - Output 4 - Scene (1 Byte – 17.001 DPT_SceneNumber)
- 45 - Output 5 - Scene (1 Byte – 17.001 DPT_SceneNumber)
- 55 - Output 6 - Scene (1 Byte – 17.001 DPT_SceneNumber)
- 65 - Output 7 - Scene (1 Byte – 17.001 DPT_SceneNumber)
- 75 - Output 8 - Scene (1 Byte – 17.001 DPT_SceneNumber)
- 85 - Output 9 - Scene (1 Byte – 17.001 DPT_SceneNumber)
- 95 - Output 10 - Scene (1 Byte – 17.001 DPT_SceneNumber)

Operating principle:

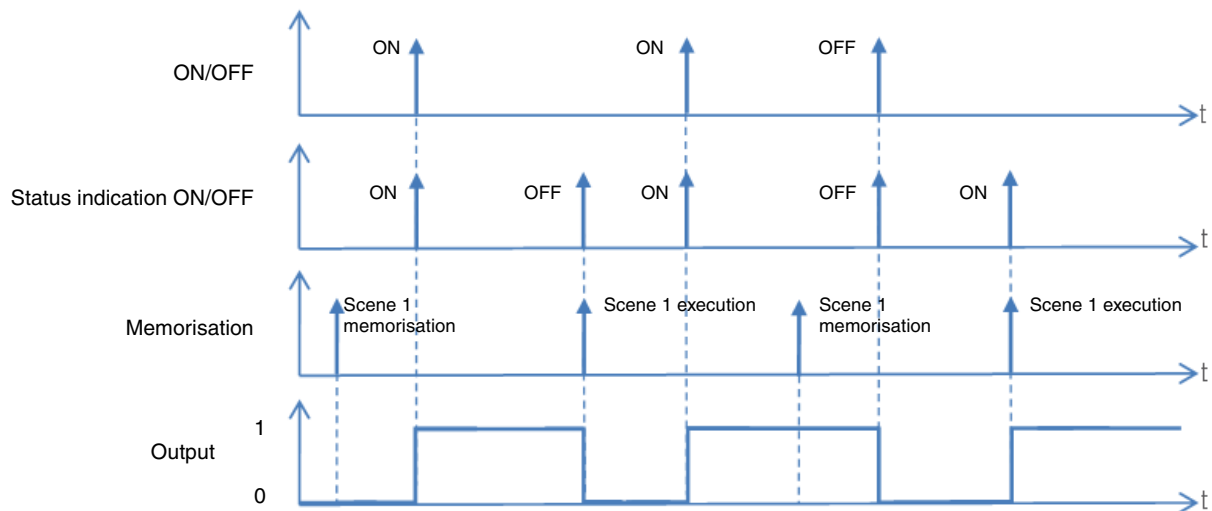

Learning and storing scenes

This process is used to change and store a scene. For example, by locally pressing the key in the room or by emission of the values from a visualization.

To access and store scenes, the following values must be sent:

Scene number	Access scene (Object value: 1 byte)	Store scene (Object value: 1 byte)
1-64	= Scene number - 1	= Scene number + 128
Examples		
1	0	128
2	1	129
3	2	130
...	...	
64	63	191

Here is the scene memorisation for local switches, for example.

- Activate scene by briefly pressing the transmitter that starts it.
- The outputs (lights, shutters, etc.) are set in the desired state using the usual local control devices (buttons, remote control, etc.).
- Memorise the status of the outputs with a press greater than 5 seconds long on the transmitter that starts the scene. The memorisation can be displayed by short-term activation of the outputs.

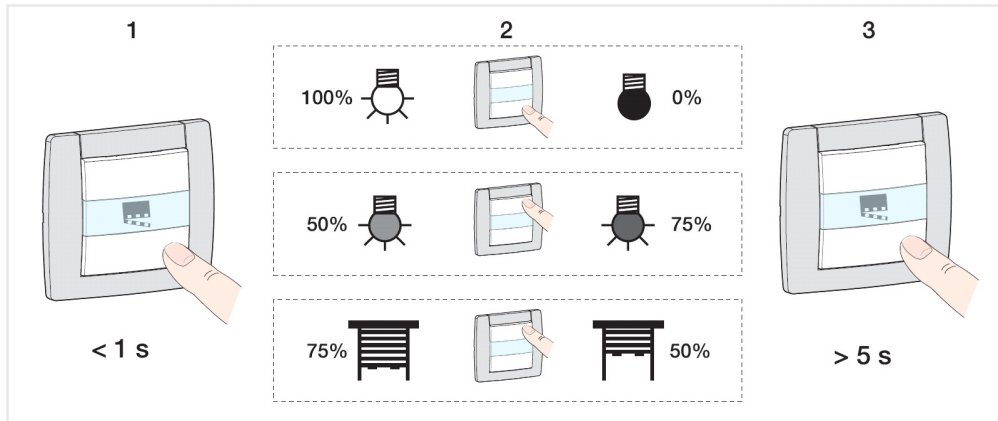

3.1.4 Functions for each shutter/blind output

Slat position for horizontal slats

The blind drive actuators have 2 limit position switches and can be run to a Sun protection position using a position setting in percent. The value of "0%" is used to control the upper position (i.e. Sun protection fully open) or is reported as a status.

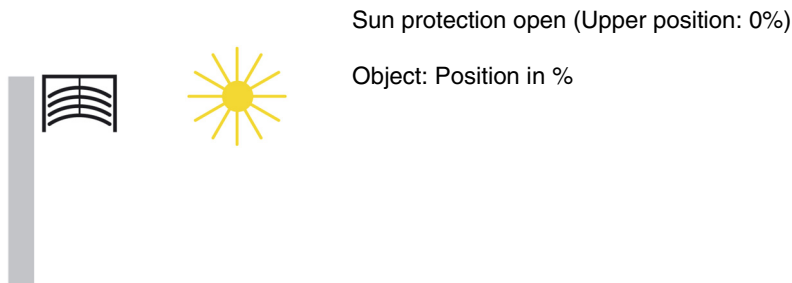

If the lower position is to be approached, then this will be sent to the blinds as Sun protection position 100% or on reaching the lower position (i.e. Sun protection completely closed). The position will be reported using this value. If a blind is run from the upper position, the slats initially tilt into an almost vertical position and then the sun protection runs with closed slats to the lower position.

When the blind is located at the lower position and the slats are fully closed, then this slat position is described as vertical and equal to 100%. Normally, however, fully closed slats have no exactly vertical position ($\alpha = 180^\circ$) but rather form a small angle with the vertical.

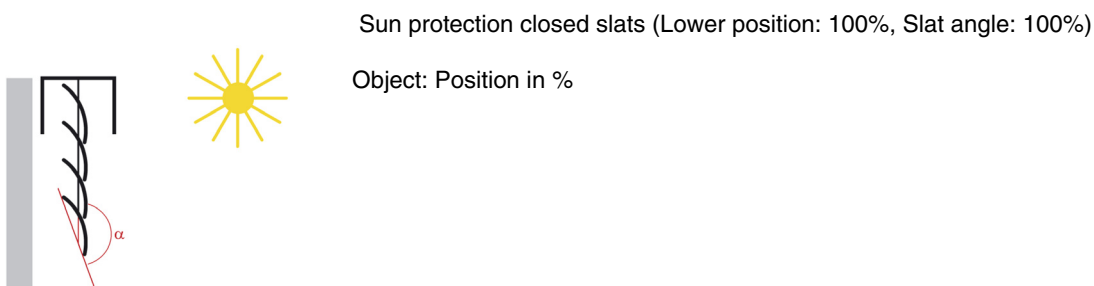

From their vertical position (completely closed, 100%) the slats can be adjusted to their horizontal position (fully open, 0% and $\alpha = 90^\circ$) The blind drive used thus determines whether this adjustment can be carried out using many small steps or whether it is only possible via a few large steps (As with most standard drives).

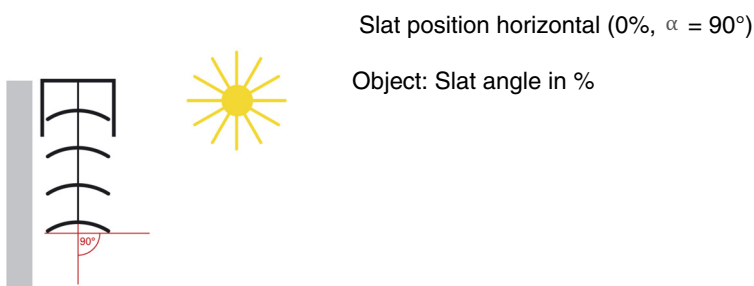

For standard blinds, the slats can be adjusted continuously to the horizontal position or until the slat adjustment ends and the raising of the blind begins. The slats then form an angle of between 0° and 90° with the vertical.

Slat position at the start of moving the blind (Up)

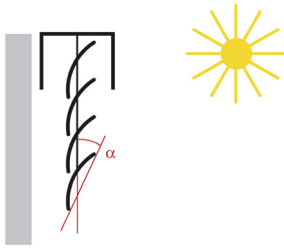

Object: Slat angle in %

Slat position for vertical slats

If an interior shade or privacy shield with vertical slats is controlled via a blind actuator, then the position in which the slats are fully open is controlled or reported as the 0% slat position. The slats then form an angle of 90° with the direction of travel from Shade fully open to Shade fully closed.

Fully opened vertical slats (Slat angle 0%)



Object: Slat angle in %

If the slats are fully closed, this position will be controlled and reported as slat position 100%. This is the position to which the shade is run from its side limit position in front of the window. The angle that the slats then form with the direction of movement is therefore a little > 0°.

Fully closed vertical slats (Slat angle 100%)

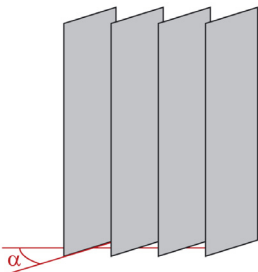

Object: Slat angle in %

If the shade is then driven back (i.e. opened), then the vertical slats are turned to a position that is somewhat smaller than 180°.

Vertical slats at the start of moving UP

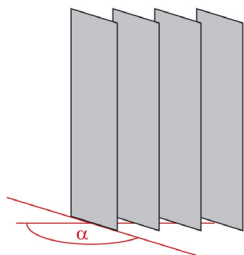

3.1.4.1 Function selection

These parameters are available individually for each output (Pair).

Outputs 1-10: Function	Closing type	<input type="radio"/> Shutter <input checked="" type="radio"/> Shutter and blind
Outputs 1-10: Fixed parameters	_____	
– Outputs 1-2	Complete up movement duration	120 <input type="text"/> Second (s)
– Outputs 1-2: Function select...	Complete down movement duration	120 <input type="text"/> Second (s)
+ Output 3	Relay closing time for slat positioning	150 <input type="text"/> milliseconds
+ Output 4	Total number of slat angles	12 <input type="text"/>
+ Output 5	_____	
+ Output 6	Status indication	<input checked="" type="checkbox"/>
+ Output 7	Position status	<input checked="" type="checkbox"/>
+ Output 8	Slat angle status	<input checked="" type="checkbox"/>
+ Output 9	Upper position reached	<input type="checkbox"/>
+ Output 10	Lower position reached	<input type="checkbox"/>
+ Information	Alarm	Not active <input type="text"/>
	Priority	<input type="checkbox"/>
	Automatic control	<input type="checkbox"/>
	Scene	<input type="checkbox"/>

Parameter	Description	Value
Closing type	This parameter defines the operating mode used for the affected outputs. An operating mode of the shutter and blind type gives access to additional parameters to control the slat pitch.	Shutter and blind* Shutter

* Default value

- Communication objects:
- 0 - Outputs 1-2 - Up/down (1 Bit – 1.008 DPT_UpDown)
 - 20 - Outputs 3-4 - Up/down (1 Bit – 1.008 DPT_UpDown)
 - 40 - Outputs 5-6 - Up/down (1 Bit – 1.008 DPT_UpDown)
 - 60 - Outputs 7-8 - Up/down (1 Bit – 1.008 DPT_UpDown)
 - 80 - Outputs 9-10 - Up/down (1 Bit – 1.008 DPT_UpDown)

 - 2 - Outputs 1-2 - Stop (Short press) (1 Bit – 1.007 DPT_Step)
 - 22 - Outputs 3-4 - Stop (Short press) (1 Bit – 1.007 DPT_Step)
 - 42 - Outputs 5-6 - Stop (Short press) (1 Bit – 1.007 DPT_Step)
 - 62 - Outputs 7-8 - Stop (Short press) (1 Bit – 1.007 DPT_Step)
 - 82 - Outputs 9-10 - Stop (Short press) (1 Bit – 1.007 DPT_Step)

 - 3 - Outputs 1-2 - Position in % (1 Byte – 5.001 DPT_Scaling)
 - 23 - Outputs 3-4 - Position in % (1 Byte – 5.001 DPT_Scaling)
 - 43 - Outputs 5-6 - Position in % (1 Byte – 5.001 DPT_Scaling)
 - 63 - Outputs 7-8 - Position in % (1 Byte – 5.001 DPT_Scaling)
 - 83 - Outputs 9-10 - Position in % (1 Byte – 5.001 DPT_Scaling)

Note: These objects are always visible.

- Communication objects:
- 1 - Outputs 1-2 - Step/stop control (Short press) (1 Bit – 1.007 DPT_Step)
 - 21 - Outputs 3-4 - Step/stop control (Short press) (1 Bit – 1.007 DPT_Step)
 - 41 - Outputs 5-6 - Step/stop control (Short press) (1 Bit – 1.007 DPT_Step)
 - 61 - Outputs 7-8 - Step/stop control (Short press) (1 Bit – 1.007 DPT_Step)
 - 81 - Outputs 9-10 - Step/stop control (Short press) (1 Bit – 1.007 DPT_Step)

 - 4 - Outputs 1-2 - Slat angle in % (1 Byte – 5.001 DPT_Scaling)
 - 24 - Outputs 3-4 - Slat angle in % (1 Byte – 5.001 DPT_Scaling)
 - 44 - Outputs 5-6 - Slat angle in % (1 Byte – 5.001 DPT_Scaling)
 - 64 - Outputs 7-8 - Slat angle in % (1 Byte – 5.001 DPT_Scaling)
 - 84 - Outputs 9-10 - Slat angle in % (1 Byte – 5.001 DPT_Scaling)

Note: These objects are only visible when the **Closing type** parameter has the value: **Shutter and blind**.

Parameter	Description	Value
Complete up movement duration	This parameter defines the time taken, during which the contact must be closed, to reach the upper position.	1... 120* ...500 s

Parameter	Description	Value
Complete down movement duration	This parameter defines the time taken, during which the contact must be closed, to reach the lower position.	1... 120* ...500 s

Parameter	Description	Value
Relay closing time for slat positioning	This parameter defines how long the contacts must be closed in order to perform an elementary angle step for the slats.	100... 150* ...2500 ms

Note: This parameter is only visible when the **Closing type** has the value: **Shutter and blind**.

* Default value

Parameter	Description	Value
Total number of slat angles	This parameter defines the total number of elementary slat steps available for adjusting the slats from the inclined downwards position to be inclined upwards position.	1... 12* ...50

*Note: Before setting the **Total number of slat angles** parameter, it is essential to first set the closed contact duration for an elementary slat step.*

*Note: This parameter is only visible when the **Closing type** has the value: **Shutter and blind**.*

3.1.4.2 Status indication

Using the Status indication function, the following can be sent via the bus:

- Status indication position in %: Indicates the position of the shutter or blind.
- Indication of slat position in %: Indicates the slat pitch of the blind.
- Upper or lower position reached: Indicates arrival at the upper or lower position.

Status indication	<input checked="" type="checkbox"/>
Position status	<input checked="" type="checkbox"/>
Slat angle status	<input checked="" type="checkbox"/>
Upper position reached	<input checked="" type="checkbox"/>
Lower position reached	<input checked="" type="checkbox"/>

Parameter	Description
Status indication	This parameter allows the display of different status indication objects of the outputs concerned.

Parameter	Description
Position status	This parameter authorizes the Position in % indication object.

Communication objects:

- 5 - Outputs 1-2 - Status indication position in %** (1 Byte – 5.001 DPT_Scaling)
- 25 - Outputs 3-4 - Status indication position in %** (1 Byte – 5.001 DPT_Scaling)
- 45 - Outputs 5-6 - Status indication position in %** (1 Byte – 5.001 DPT_Scaling)
- 65 - Outputs 7-8 - Status indication position in %** (1 Byte – 5.001 DPT_Scaling)
- 85 - Outputs 9-10 - Status indication position in %** (1 Byte – 5.001 DPT_Scaling)

Parameter	Description
Slat angle status	This parameter authorizes the Slat angle indication in % object.

*Note: This parameter is only visible when the **Closing type** has the value: **Shutter and blind**.*

* Default value

- Communication objects
- 6 - Outputs 1-2 - Slat angle indication in % (1 Byte – 5.001 DPT_Scaling)
 - 26 - Outputs 3-4 - Slat angle indication in % (1 Byte – 5.001 DPT_Scaling)
 - 46 - Outputs 5-6 - Slat angle indication in % (1 Byte – 5.001 DPT_Scaling)
 - 66 - Outputs 7-8 - Slat angle indication in % (1 Byte – 5.001 DPT_Scaling)
 - 86 - Outputs 9-10 - Slat angle indication in % (1 Byte – 5.001 DPT_Scaling)

Parameter	Description
Upper position reached	This parameter authorizes the Upper position reached object.

- Communication objects
- 7 - Outputs 1-2 - Upper position reached (1 Bit – 1.002 DPT_Bool)
 - 27 - Outputs 3-4 - Upper position reached (1 Bit – 1.002 DPT_Bool)
 - 47 - Outputs 5-6 - Upper position reached (1 Bit – 1.002 DPT_Bool)
 - 67 - Outputs 7-8 - Upper position reached (1 Bit – 1.002 DPT_Bool)
 - 87 - Outputs 9-10 - Upper position reached (1 Bit – 1.002 DPT_Bool)

Parameter	Description
Lower position reached	This parameter authorizes the Lower position reached object.

- Communication objects
- 8 - Outputs 1-2 - Lower position reached (1 Bit – 1.002 DPT_Bool)
 - 28 - Outputs 3-4 - Lower position reached (1 Bit – 1.002 DPT_Bool)
 - 48 - Outputs 5-6 - Lower position reached (1 Bit – 1.002 DPT_Bool)
 - 68 - Outputs 7-8 - Lower position reached (1 Bit – 1.002 DPT_Bool)
 - 88 - Outputs 9-10 - Lower position reached (1 Bit – 1.002 DPT_Bool)

3.1.4.3 Alarm

With the Alarm function a shutter or blind can be positioned in a configurable predefined state.

Priority: **Alarm**> Priority > Basic function.

The alarm prevents any actuation until an alarm cancellation command has been received.

Up to 3 alarm functions are possible (Alarm 1 - Alarm 2 - Alarm 3).

When an alarm appears, change in output status is defined by a setting (Up, Down, Unchanged position).

If they are activated, the alarm objects must be filled in cyclically. The time between 2 objects being sent must be less than 30 minutes. If not, the alarm will trigger automatically.

After the alarm, the shutter or blind takes up the position it would be in if no alarm had occurred.

Alarm	Alarm 1 > Alarm 2 > Alarm 3
Position on alarm 1	Maintain status
Position on alarm 2	Maintain status
Position on alarm 3	Maintain status

Parameter	Description	Value
Alarm	The Alarm tab and the associated parameters and objects are: Hidden Displayed for 1 alarm object Displayed for 2 alarm objects Displayed for 3 alarm objects	Not active* Alarm 1 Alarm 1 > Alarm 2 Alarm 1 > Alarm 2 > Alarm 3

Communication objects

- [12 - Outputs 1-2 - Alarm 1](#) (1 Bit – 1.005 DPT_Alarm)
- [32 - Outputs 3-4 - Alarm 1](#) (1 Bit – 1.005 DPT_Alarm)
- [52 - Outputs 5-6 - Alarm 1](#) (1 Bit – 1.005 DPT_Alarm)
- [72 - Outputs 7-8 - Alarm 1](#) (1 Bit – 1.005 DPT_Alarm)
- [92 - Outputs 9-10 - Alarm 1](#) (1 Bit – 1.005 DPT_Alarm)

Communication objects

- [13 - Outputs 1-2 - Alarm 2](#) (1 Bit – 1.005 DPT_Alarm)
- [33 - Outputs 3-4 - Alarm 2](#) (1 Bit – 1.005 DPT_Alarm)
- [53 - Outputs 5-6 - Alarm 2](#) (1 Bit – 1.005 DPT_Alarm)
- [73 - Outputs 7-8 - Alarm 2](#) (1 Bit – 1.005 DPT_Alarm)
- [93 - Outputs 9-10 - Alarm 2](#) (1 Bit – 1.005 DPT_Alarm)

Communication objects

- [14 - Outputs 1-2 - Alarm 3](#) (1 Bit – 1.005 DPT_Alarm)
- [34 - Outputs 3-4 - Alarm 3](#) (1 Bit – 1.005 DPT_Alarm)
- [54 - Outputs 5-6 - Alarm 3](#) (1 Bit – 1.005 DPT_Alarm)
- [74 - Outputs 7-8 - Alarm 3](#) (1 Bit – 1.005 DPT_Alarm)
- [94 - Outputs 9-10 - Alarm 3](#) (1 Bit – 1.005 DPT_Alarm)

* Default value

Operating principle:

Example:

- Position on alarm 2: up.
- Position on alarm 1: down.

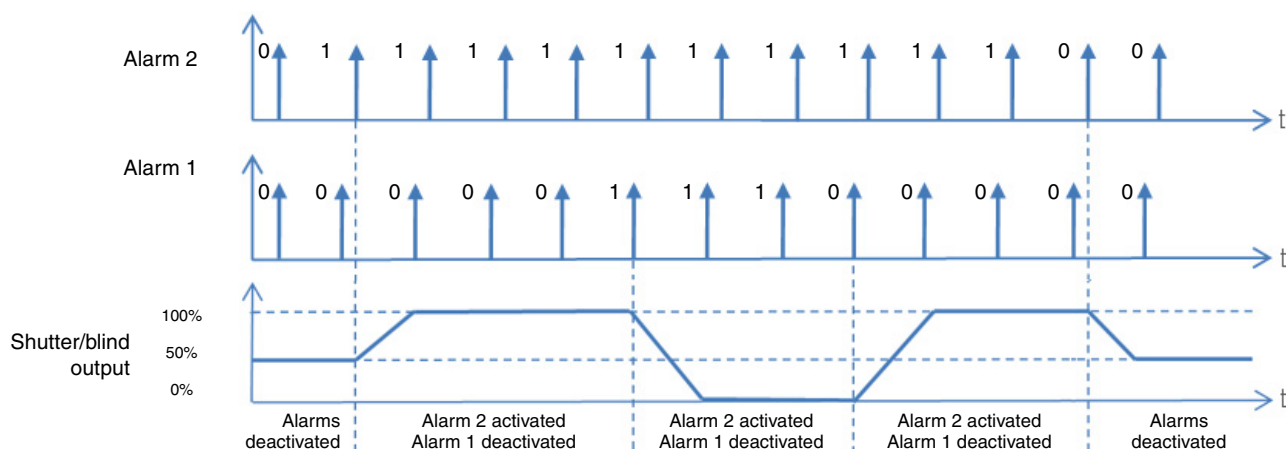

If several alarms triggered at the same time, the commands associated with the highest priority alarm are executed.

Parameter	Description	Value
Position on alarm X	On Alarm X, the shutter/blind output: Not changed Closes the Up contact Closes the down contact	Not active* Up Down

X = 1 - 2 - 3

3.1.4.4 Priority

The Priority function is used to force the output into a defined state.

Priority: Alarm > **Priority** > Basic function.

Only a Priority OFF command authorizes the output for control.

At the end of the priority, the output returns to the status it had before the priority (Memorisation function).

The device responds to telegrams received via the **Priority** object, as given in the following table:

Telegram received by the priority operation object			Output behaviour
Hexadecimal Value	Binary Value		
	Bit 1 (MSB)	Bit 0 (LSB)	
00	0	0	End of the priority
01	0	1	End of the priority
02	1	0	Priority up
03	1	1	Priority down

* Default value

Operating principle:

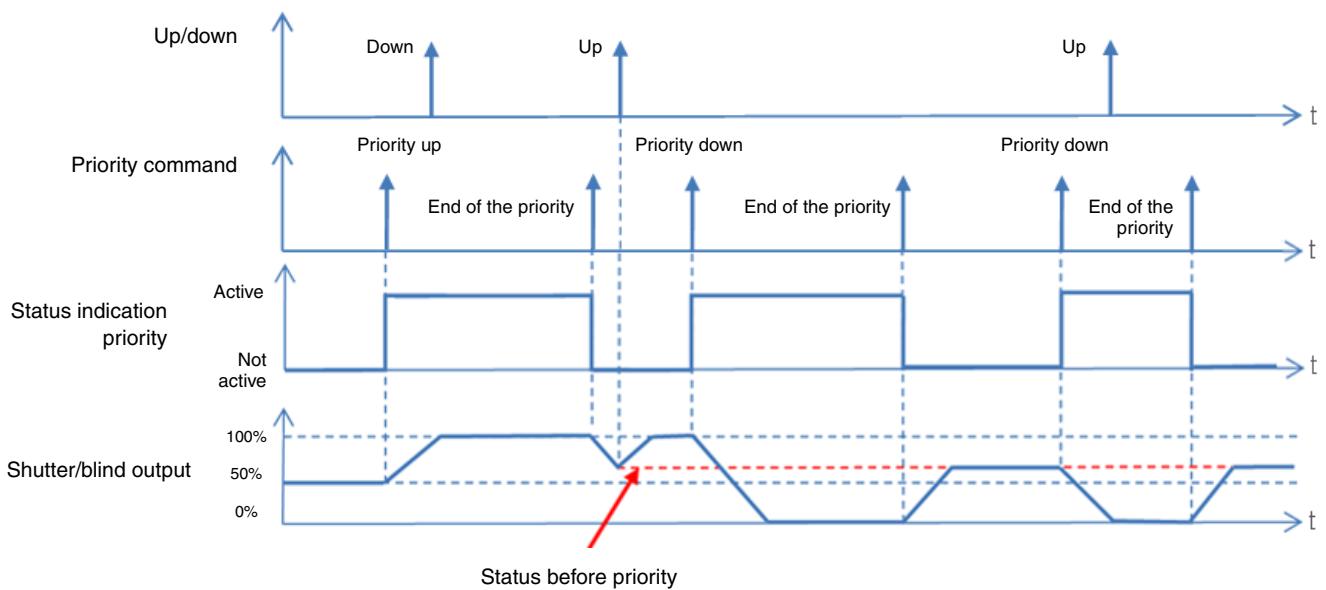

Communication objects

- 9 - Outputs 1-2 - Priority** (2 Bit – 2.002 DPT_Bool_Control)
- 29 - Outputs 3-4 - Priority** (2 Bit – 2.002 DPT_Bool_Control)
- 49 - Outputs 5-6 - Priority** (2 Bit – 2.002 DPT_Bool_Control)
- 69 - Outputs 7-8 - Priority** (2 Bit – 2.002 DPT_Bool_Control)
- 89 - Outputs 9-10 - Priority** (2 Bit – 2.002 DPT_Bool_Control)
- 10 - Outputs 1-2 - Status indication priority** (1 Bit – 1.011 DPT_State)
- 30 - Outputs 3-4 - Status indication priority** (1 Bit – 1.011 DPT_State)
- 50 - Outputs 5-6 - Status indication priority** (1 Bit – 1.011 DPT_State)
- 70 - Outputs 7-8 - Status indication priority** (1 Bit – 1.011 DPT_State)
- 90 - Outputs 9-10 - Status indication priority** (1 Bit – 1.011 DPT_State)

3.1.4.5 Automatic control

The Automatic control function is used to control an output in parallel to the Up/Down or Slat tilt/stop function.

The functions have the same level of priority. The last command received will act on the status of the output. An additional command object is used to activate or deactivate the Automatic control.

Example: when an output is controlled by a button and in parallel by an automatic control (timer, twilight switch, weather station, etc.) the automatic control can be deactivated for reasons of comfort (vacations, public holidays, etc.).

Automatic control	<input checked="" type="checkbox"/>
Automatic control deactivation	<input checked="" type="checkbox"/>

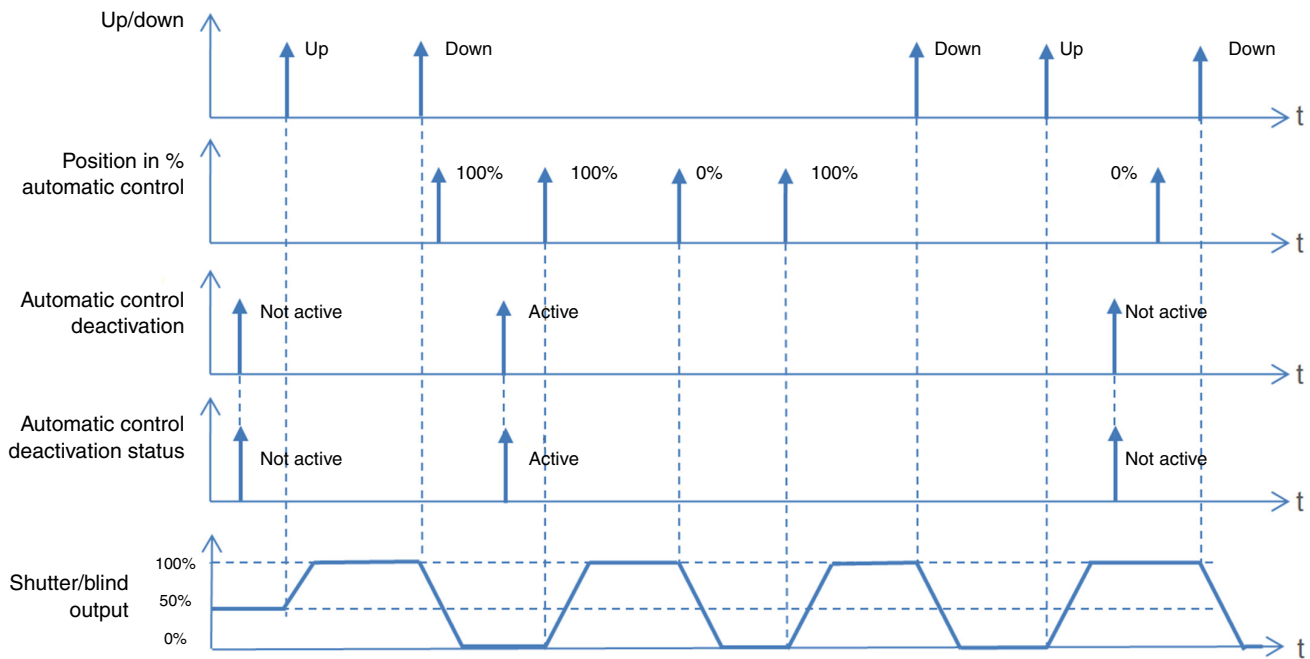

Communication objects

- 15 - Output 1-2 - Position in % automatic control** (1 Bit – 1.001 DPT_Switch)
- 35 - Output 3-4 - Position in % automatic control** (1 Bit – 1.001 DPT_Switch)
- 55 - Output 5-6 - Position in % automatic control** (1 Bit – 1.001 DPT_Switch)
- 75 - Output 7-8 - Position in % automatic control** (1 Bit – 1.001 DPT_Switch)
- 95 - Output 9-10 - Position in % automatic control** (1 Bit – 1.001 DPT_Switch)
- 16 - Output 1-2 - Slat angle in % automatic control** (1 Bit – 1.001 DPT_Switch)
- 36 - Output 3-4 - Slat angle in % automatic control** (1 Bit – 1.001 DPT_Switch)
- 56 - Output 5-6 - Slat angle in % automatic control** (1 Bit – 1.001 DPT_Switch)
- 76 - Output 7-8 - Slat angle in % automatic control** (1 Bit – 1.001 DPT_Switch)
- 96 - Output 9-10 - Slat angle in % automatic control** (1 Bit – 1.001 DPT_Switch)

Communication objects

- 17 - Output 1-2 - Automatic control deactivation** (1 Bit – 1.001 DPT_Switch)
- 37 - Output 3-4 - Automatic control deactivation** (1 Bit – 1.001 DPT_Switch)
- 57 - Output 5-6 - Automatic control deactivation** (1 Bit – 1.001 DPT_Switch)
- 77 - Output 7-8 - Automatic control deactivation** (1 Bit – 1.001 DPT_Switch)
- 97 - Output 9-10 - Automatic control deactivation** (1 Bit – 1.001 DPT_Switch)
- 18 - Output 1-2 - Automatic control deactivation status** (1 Bit – 1.001 DPT_Switch)
- 38 - Output 3-4 - Automatic control deactivation status** (1 Bit – 1.001 DPT_Switch)
- 58 - Output 5-6 - Automatic control deactivation status** (1 Bit – 1.001 DPT_Switch)
- 78 - Output 7-8 - Automatic control deactivation status** (1 Bit – 1.001 DPT_Switch)
- 98 - Output 9-10 - Automatic control deactivation status** (1 Bit – 1.001 DPT_Switch)

3.1.4.6 Scene

The Scene function is used to switch groups of outputs into a configurable predefined state. Pressing a push button activates a scene.

A scene is activated by receipt of a 1-byte command.

Each output can be included in 64 different scenes.

When the scene is memorised, the position and angle of the slats are memorised.

Scene

Number of scenes used

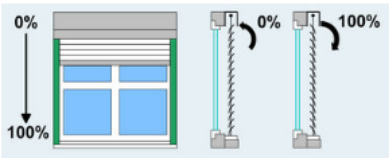

Scene 1

Position for scene 1 (0-100%) %

Slat angle for scene 1 (0-100%) %

Scene 2

Scene 3

Scene 4

Scene 5

Scene 6

Scene 7

Scene 8

Parameter	Description	Value
Number of scenes used	This parameter determines the number of scenes used.	8* - 16 - 24 - 32 - 48 - 64

Note: If the Scene number received on the Scene object is greater than the maximum number of scenes, the status of the output remains unchanged.

Parameter	Description
Scene X	This parameter is used to activate the scene in question.

X = 1 to 64

Parameter	Description	Value
Position for scene X (0-100%)	This parameter defines the position to run the shutter or blind to for scene X.	0*...100

* Default value

Parameter	Description	Value
Slat angle for scene X (0-100%)	This parameter defines the slat position of the blind to be used for scene X.	0*...100

Note: This parameter is only visible when the **Closing type** has the value **Shutter and blind**.

- Communication objects
- 11 - Output 1-2 - Scene (1 Byte – 17.001 DPT_SceneNumber)
 - 31 - Output 3-4 - Scene (1 Byte – 17.001 DPT_SceneNumber)
 - 51 - Output 5-6 - Scene (1 Byte – 17.001 DPT_SceneNumber)
 - 71 - Output 7-8 - Scene (1 Byte – 17.001 DPT_SceneNumber)
 - 91 - Output 9-10 - Scene (1 Byte _17.001_DPT_SceneNumber)

Operating principle:

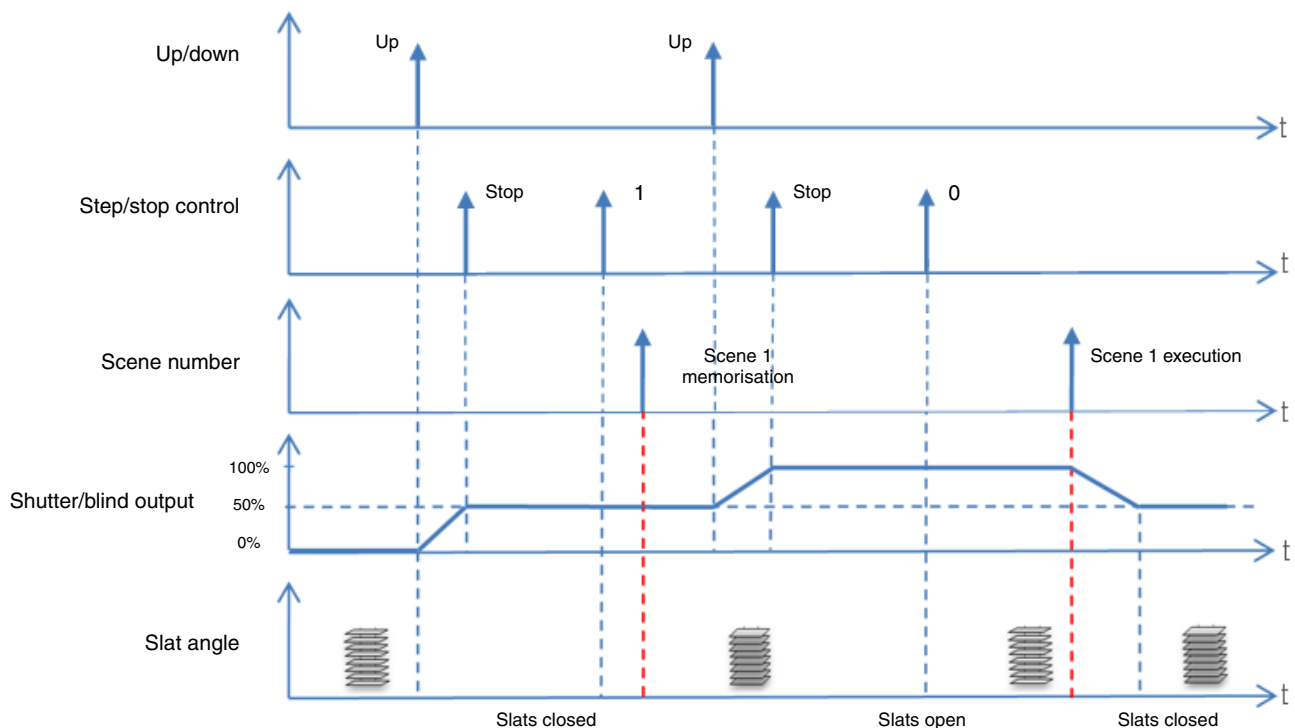

* Default value

Learning and storing scenes

This process is used to change and store a scene. For example, by locally pressing the key in the room or by emission of the values from a visualization.

To access and store scenes, the following values must be sent:

Scene number	Access scene (Object value: 1 byte)	Store scene (Object value: 1 byte)
1-64	= Scene number - 1	= Scene number + 128
Examples		
1	0	128
2	1	129
3	2	130
...	...	
64	63	191

Here is the scene memorisation for local switches, for example.

- Activate scene by briefly pressing the transmitter that starts it.
- The outputs (lights, shutters, etc.) are set in the desired state using the usual local control devices (buttons, remote control, etc.).
- Memorise the status of the outputs with a press greater than 5 seconds long on the transmitter that starts the scene. The memorisation can be displayed by short-term activation of the outputs.

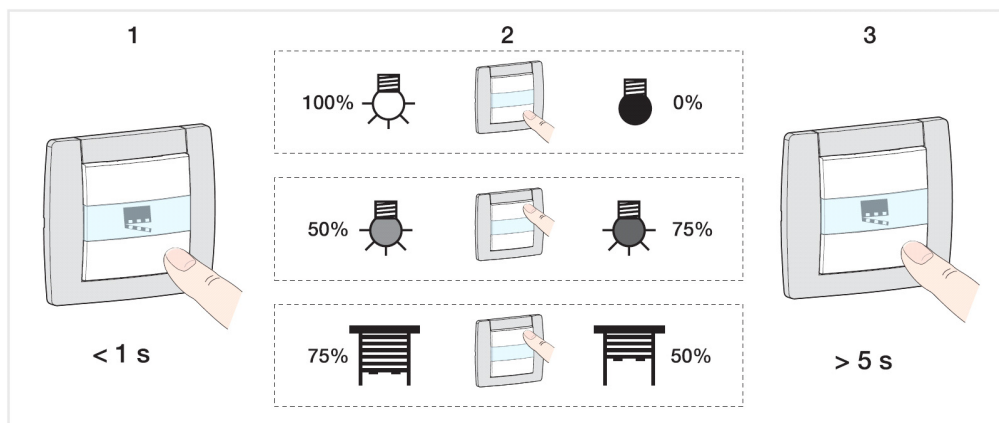

3.2 Communication objects

3.2.1 Output communication objects ON/OFF

	Number	Name	Function of the object	Length	C	R	W	T
	0	Output 1	ON/OFF	1 bit	C	R	W	-
	1	Output 1	Status indication ON/OFF	1 bit	C	R	-	T
	2	Output 1	Timer	1 bit	C	R	W	-
	3	Output 1	Priority	2 bit	C	R	W	-
	4	Output 1	Status indication priority	1 bit	C	R	-	T
	5	Output 1	Scene	1 byte	C	R	W	-
	6	Output 1	ON/OFF automatic control	1 bit	C	R	W	-
	7	Output 1	Automatic control deactivation	1 bit	C	R	W	-
	8	Output 1	Automatic control deactivation status	1 bit	C	R	-	T
	9	Output 1	Load shedding	1 bit	C	R	W	-
	10	Output 1	ON/OFF	1 bit	C	R	W	-
	11	Output 2	Status indication ON/OFF	1 bit	C	R	-	T
	12	Output 2	Timer	1 bit	C	R	W	-
	13	Output 2	Priority	2 bit	C	R	W	-
	14	Output 2	Status indication priority	1 bit	C	R	-	T
	15	Output 2	Scene	1 byte	C	R	W	-
	16	Output 2	ON/OFF automatic control	1 bit	C	R	W	-
	17	Output 2	Automatic control deactivation	1 bit	C	R	W	-
	18	Output 2	Automatic control deactivation status	1 bit	C	R	-	T
	19	Output 2	Load shedding	1 bit	C	R	W	-
	20	Output 3	ON/OFF	1 bit	C	R	W	-
	21	Output 3	Status indication ON/OFF	1 bit	C	R	-	T
	22	Output 3	Timer	1 bit	C	R	W	-
	23	Output 3	Priority	2 bit	C	R	W	-
	24	Output 3	Status indication priority	1 bit	C	R	-	T
	25	Output 3	Scene	1 byte	C	R	W	-
	26	Output 3	ON/OFF automatic control	1 bit	C	R	W	-
	27	Output 3	Automatic control deactivation	1 bit	C	R	W	-
	28	Output 3	Automatic control deactivation status	1 bit	C	R	-	T
	29	Output 3	Load shedding	1 bit	C	R	W	-
	30	Output 4	ON/OFF	1 bit	C	R	W	-
	31	Output 4	Status indication ON/OFF	1 bit	C	R	-	T
	32	Output 4	Timer	1 bit	C	R	W	-
	33	Output 4	Priority	2 bit	C	R	W	-
	34	Output 4	Status indication priority	1 bit	C	R	-	T
	35	Output 4	Scene	1 byte	C	R	W	-
	36	Output 4	ON/OFF automatic control	1 bit	C	R	W	-
	37	Output 4	Automatic control deactivation	1 bit	C	R	W	-
	38	Output 4	Automatic control deactivation status	1 bit	C	R	-	T
	39	Output 4	Load shedding	1 bit	C	R	W	-

	Number	Name	Function of the object	Length	C	R	W	T
	40	Output 5	ON/OFF	1 bit	C	R	W	-
	41	Output 5	Status indication ON/OFF	1 bit	C	R	-	T
	42	Output 5	Timer	1 bit	C	R	W	-
	43	Output 5	Priority	2 bit	C	R	W	-
	44	Output 5	Status indication priority	1 bit	C	R	-	T
	45	Output 5	Scene	2 byte	C	R	W	-
	46	Output 5	ON/OFF automatic control	1 bit	C	R	W	-
	47	Output 5	Automatic control deactivation	1 bit	C	R	W	-
	48	Output 5	Automatic control deactivation status	1 bit	C	R	-	T
	49	Output 5	Load shedding	1 bit	C	R	W	-
	50	Output 6	ON/OFF	1 bit	C	R	W	-
	51	Output 6	Status indication ON/OFF	1 bit	C	R	-	T
	52	Output 6	Timer	1 bit	C	R	W	-
	53	Output 6	Priority	2 bit	C	R	W	-
	54	Output 6	Status indication priority	2 bit	C	R	-	T
	55	Output 6	Scene	1 byte	C	R	W	-
	56	Output 6	ON/OFF automatic control	1 bit	C	R	W	-
	57	Output 6	Automatic control deactivation	1 bit	C	R	W	-
	58	Output 6	Automatic control deactivation status	1 bit	C	R	-	T
	59	Output 6	Load shedding	1 bit	C	R	W	-
	60	Output 7	ON/OFF	1 bit	C	R	W	-
	61	Output 7	Status indication ON/OFF	1 bit	C	R	-	T
	62	Output 7	Timer	1 bit	C	R	W	-
	63	Output 7	Priority	2 bit	C	R	W	-
	64	Output 7	Status indication priority	1 bit	C	R	-	T
	65	Output 7	Scene	1 byte	C	R	W	-
	66	Output 7	ON/OFF automatic control	1 bit	C	R	W	-
	67	Output 7	Automatic control deactivation	1 bit	C	R	W	-
	68	Output 7	Automatic control deactivation status	1 bit	C	R	-	T
	69	Output 7	Load shedding	1 bit	C	R	W	-
	70	Output 8	ON/OFF	1 bit	C	R	W	-
	71	Output 8	Status indication ON/OFF	1 bit	C	R	-	T
	72	Output 8	Timer	1 bit	C	R	W	-
	73	Output 8	Priority	2 bit	C	R	W	-
	74	Output 8	Status indication priority	1 bit	C	R	-	T
	75	Output 8	Scene	1 byte	C	R	W	-
	76	Output 8	ON/OFF automatic control	1 bit	C	R	W	-
	77	Output 8	Automatic control deactivation	1 bit	C	R	W	-
	78	Output 8	Automatic control deactivation status	1 bit	C	R	-	T
	79	Output 8	Load shedding	1 bit	C	R	W	-

	Number	Name	Function of the object	Length	C	R	W	T
	80	Output 9	ON/OFF	1 bit	C	R	W	-
	81	Output 9	Status indication ON/OFF	1 bit	C	R	-	T
	82	Output 9	Timer	1 bit	C	R	W	-
	83	Output 9	Priority	2 bit	C	R	W	-
	84	Output 9	Status indication priority	1 bit	C	R	-	T
	85	Output 9	Scene	1 byte	C	R	W	-
	86	Output 9	ON/OFF automatic control	1 bit	C	R	W	-
	87	Output 9	Automatic control deactivation	1 bit	C	R	W	-
	88	Output 9	Automatic control deactivation status	1 bit	C	R	-	T
	89	Output 9	Load shedding	1 bit	C	R	W	-
	90	Output 10	ON/OFF	1 bit	C	R	W	-
	91	Output 10	Status indication ON/OFF	1 bit	C	R	-	T
	92	Output 10	Timer	1 bit	C	R	W	-
	93	Output 10	Priority	2 bit	C	R	W	-
	94	Output 10	Status indication priority	1 bit	C	R	-	T
	95	Output 10	Scene	1 byte	C	R	W	-
	96	Output 10	ON/OFF automatic control	1 bit	C	R	W	-
	97	Output 10	Automatic control deactivation	1 bit	C	R	W	-
	98	Output 10	Automatic control deactivation status	1 bit	C	R	-	T
	99	Output 10	Load shedding	1 bit	C	R	W	-

Note: For devices with additional outputs, object designation is identical. Only the object number differs.

3.2.1.1 ON/OFF

No.	Name	Function of the object	Data type	Flags
0, 10, 20, 30, 40, 50, 60, 70, 80, 90	Output x	ON/OFF	1 bit - 1.001 DPT_Switch	C, R, W

These objects are always activated.
They enable switching of the output contact in accordance with the value that is sent via the KNX bus.

Normally open:

- On input of an OFF command, the output relay contact opens.
- On input of an ON command, the output relay contact closes.

3.2.1.2 Status indication

No.	Name	Function of the object	Data type	Flags
1, 11, 21, 31, 41, 51, 61, 71, 81, 91	Output x-y	Status indication ON/OFF	1 bit - 1.001 DPT_Switch	C, R, T

These objects are always activated.
This object allows the status of the output contact to be sent from the device over the KNX bus.

Object value:

- If the output relay is open, a telegram with logic value "0" is sent on the KNX bus.
- If the output relay is closed, a telegram with logic value "1" is sent on the KNX bus.

This object is sent when there is a status change.

3.2.1.3 Timer

No.	Name	Function of the object	Data type	Flags
2, 12, 22, 32, 42, 52, 62, 72, 82, 92	Output x	Timer	1 bit - 1.010 DPT_Start	C, R, W

This object is activated when the **Timer** parameter is active.
This object is used to activate the Timer function of the device via the KNX bus.

Object value:

- If a rising edge (0 to 1) arrives at this object, the output switches for a configurable period.
- If a falling edge (1 to 0) arrives at this object, the output remains in its current state.

Note: The timer duration can be interrupted by a long press on the button controlling the timer.
Note: When a start command is received during the timer, the timer duration is reset.

For further information, see: [Timer](#).

3.2.1.4 Priority

No.	Name	Function of the object	Data type	Flags
3, 13, 23, 33, 43, 53, 63, 73, 83, 93	Output x	Priority	2 bit - 2.002 DPT_Bool_Control	C, R, W

This object is activated if the **Priority** parameter is active.
 The status of the output contact is determined directly by this object.
 Details on the format of the object are given below.

Telegram received by the priority operation object			Output behaviour
Hexadecimal Value	Binary Value		
	Bit 1 (MSB)	Bit 0 (LSB)	
00	0	0	End of the priority
01	0	1	End of the priority
02	1	0	Priority OFF
03	1	1	Priority ON

The first bit of this object (Bit 0) determines the status of the output contact, which should be priority controlled. The second bit activates or deactivates the Priority.

For further information, see: [Priority](#).

No.	Name	Function of the object	Data type	Flags
4, 14, 24, 34, 44, 54, 64, 74, 84, 94	Output x	Status indication priority	1 bit - 1.011 DPT_State	C, R, T

This object is activated if the **Priority** parameter is active.
 This object allows the status of the Priority to be sent from the device on the KNX bus.
 Object value:

0 = Not forced, 1 = Forced:

- If Priority is deactivated, a telegram is sent with logic value "0".
- If Priority is activated, a telegram is sent with logic value "1".

This object is sent when there is a status change.

For further information, see: [Priority](#).

3.2.1.5 Scene

No.	Name	Function of the object	Data type	Flags																
5, 15, 25, 45, 55, 65, 75, 85, 95,	Output x-y	Scene	1 byte - 18.001 DPT_SceneNumber	C, R, W																
<p>This object is activated when the Scene parameter is active. This object is used to recall or save a scene. Details on the format of the object are given below.</p> <table border="1" style="margin-left: auto; margin-right: auto;"> <tr> <td style="text-align: center;">7</td> <td style="text-align: center;">6</td> <td style="text-align: center;">5</td> <td style="text-align: center;">4</td> <td style="text-align: center;">3</td> <td style="text-align: center;">2</td> <td style="text-align: center;">1</td> <td style="text-align: center;">0</td> </tr> <tr> <td style="text-align: center;">Learning</td> <td style="text-align: center;">Not used</td> <td colspan="6" style="text-align: center;">Scene number</td> </tr> </table> <p>Bit 7: 0: The scene is called 1: The scene is saved. Bit 6: Not used. Bit 5: Scene numbers from 0 (Scene 1) to 63 (Scene 64).</p> <p>For further information, see: Scene .</p>					7	6	5	4	3	2	1	0	Learning	Not used	Scene number					
7	6	5	4	3	2	1	0													
Learning	Not used	Scene number																		

3.2.1.6 ON/OFF automatic control

No.	Name	Function of the object	Data type	Flags
6, 16, 26, 36, 46, 56, 66, 76, 86, 96,	Output x	ON/OFF automatic control	1 bit - 1.001 DPT_Switch	C, R, W
<p>This object is activated when the Automatic control parameter is active. They enable switching of the output contact in accordance with the value that is sent via the KNX bus.</p> <p>Normally open:</p> <ul style="list-style-type: none"> - On input of an OFF command, the output relay contact opens. - On input of an ON command, the output relay contact closes. <p>For further information, see: Automatic control.</p>				

3.2.1.7 Automatic control deactivation

No.	Name	Function of the object	Data type	Flags
7, 17, 27, 37, 47, 57, 67, 77, 87, 97,	Output x	Automatic control deactivation	1 bit - 1.003 DPT_Enable	C, R, W

This object is activated when the **Automatic control deactivation** parameter is active.
This object is used to activate the automatic control function.

Object value:

- If the object receives the value 0, the automatic control function is inactive.
- If the object receives the value 1, the automatic control function is active.

For further information, see: [Automatic control](#).

No.	Name	Function of the object	Data type	Flags
8, 18, 28, 38, 48, 58, 68, 78, 88, 98,	Output x	Automatic control deactivation status	1 bit - 1.003 DPT_Enable	C, R, T

This object is activated when the **Automatic control deactivation** parameter is active.
This object is used to send the status of the Automatic control deactivation function of the device on the KNX bus.

Object value:

- If the Automatic control deactivation function is deactivated, a telegram with a logical value "0" is sent.
- If the Automatic control deactivation function is activated, a telegram with a logical value "1" is sent.

This object is sent when there is a status change.
For further information, see: [Automatic control](#).

3.2.1.8 Load shedding

No.	Name	Function of the object	Data type	Flags
9, 19, 29, 39, 49, 59, 69, 79, 89, 99,	Output x	Load shedding	1 bit - 1.002 DPT_Bool	C, R, W

This object is activated when the **Load shedding** parameter is active.
This object is used to force an output to OFF.

Object value:

- If the object receives the value 0, the output remains unchanged.
- If the object receives the value 1, the output is forced to OFF.

For further information, see: [Load shedding](#).

3.2.2 Communication objects for each shutter/blind output

	Number	Name	Function of the object	Length	C	R	W	T
	0	Outputs 1-2	Up/down	1 bit	C	R	W	-
	1	Outputs 1-2	Step/stop (short press)	1 bit	C	R	W	-
	2	Outputs 1-2	Stop (Short press)	1 bit	C	R	W	-
	3	Outputs 1-2	Position in %	1 byte	C	R	W	-
	4	Outputs 1-2	Slat angle (0-100%)	1 byte	C	R	W	-
	5	Outputs 1-2	Position in % indication	1 byte	C	R	-	T
	6	Outputs 1-2	Slat angle indication in %	1 byte	C	R	-	T
	7	Outputs 1-2	Upper position reached	1 bit	C	R	-	T
	8	Outputs 1-2	Lower position reached	1 bit	C	R	-	T
	9	Outputs 1-2	Priority	2 bit	C	R	W	-
	10	Outputs 1-2	Status indication priority	1 bit	C	R	-	T
	11	Outputs 1-2	Scene	1 byte	C	R	W	-
	12	Outputs 1-2	Alarm 1	1 bit	C	R	W	-
	13	Outputs 1-2	Alarm 2	1 bit	C	R	W	-
	14	Outputs 1-2	Alarm 3	1 bit	C	R	W	-
	15	Outputs 1-2	Position in % automatic control	1 byte	C	R	W	-
	16	Outputs 1-2	Slat angle in % automatic control	1 byte	C	R	W	-
	17	Outputs 1-2	Automatic control deactivation	1 bit	C	R	W	-
	18	Outputs 1-2	Automatic control deactivation status	1 bit	C	R	W	T
	20	Outputs 3-4	Up/down	1 bit	C	R	W	-
	21	Outputs 3-4	Step/stop (short press)	1 bit	C	R	W	-
	22	Outputs 3-4	Stop (Short press)	1 bit	C	R	W	-
	23	Outputs 3-4	Position in %	1 byte	C	R	W	-
	24	Outputs 3-4	Slat angle (0-100%)	1 byte	C	R	W	-
	25	Outputs 3-4	Position in % indication	1 byte	C	R	-	T
	26	Outputs 3-4	Slat angle indication in %	1 byte	C	R	-	T
	27	Outputs 3-4	Upper position reached	1 bit	C	R	-	T
	28	Outputs 3-4	Lower position reached	1 bit	C	R	-	T
	29	Outputs 3-4	Priority	2 bit	C	R	W	-
	30	Outputs 3-4	Status indication priority	1 bit	C	R	-	T
	31	Outputs 3-4	Scene	1 byte	C	R	W	-
	32	Outputs 3-4	Alarm 1	1 bit	C	R	W	-
	33	Outputs 3-4	Alarm 2	1 bit	C	R	W	-
	34	Outputs 3-4	Alarm 3	1 bit	C	R	W	-
	35	Outputs 3-4	Position in % automatic control	1 byte	C	R	W	-
	36	Outputs 3-4	Slat angle in % automatic control	1 byte	C	R	W	-
	37	Outputs 3-4	Automatic control deactivation	1 bit	C	R	W	-
	38	Outputs 3-4	Automatic control deactivation status	1 bit	C	R	-	T

	Number	Name	Function of the object	Length	C	R	W	T
	40	Outputs 5-6	Up/down	1 bit	C	R	W	-
	41	Outputs 5-6	Step/stop (short press)	1 bit	C	R	W	-
	42	Outputs 5-6	Stop (Short press)	1 bit	C	R	W	-
	43	Outputs 5-6	Position in %	1 byte	C	R	W	-
	44	Outputs 5-6	Slat angle (0-100%)	1 byte	C	R	W	-
	45	Outputs 5-6	Position in % indication	1 byte	C	R	-	T
	46	Outputs 5-6	Slat angle indication in %	1 byte	C	R	-	T
	47	Outputs 5-6	Upper position reached	1 bit	C	R	-	T
	48	Outputs 5-6	Lower position reached	1 bit	C	R	-	T
	49	Outputs 5-6	Priority	2 bit	C	R	W	-
	50	Outputs 5-6	Status indication priority	1 bit	C	R	-	T
	51	Outputs 5-6	Scene	1 byte	C	R	W	-
	52	Outputs 5-6	Alarm 1	1 bit	C	R	W	-
	53	Outputs 5-6	Alarm 2	1 bit	C	R	W	-
	54	Outputs 5-6	Alarm 3	1 bit	C	R	W	-
	55	Outputs 5-6	Position in % automatic control	1 byte	C	R	W	-
	56	Outputs 5-6	Slat angle in % automatic control	1 byte	C	R	W	-
	57	Outputs 5-6	Automatic control deactivation	1 bit	C	R	W	-
	58	Outputs 5-6	Automatic control deactivation status	1 bit	C	R	-	T
	60	Outputs 7-8	Up/down	1 bit	C	R	W	-
	61	Outputs 7-8	Step/stop (short press)	1 bit	C	R	W	-
	62	Outputs 7-8	Stop (Short press)	1 bit	C	R	W	-
	63	Outputs 7-8	Position in %	1 byte	C	R	W	-
	64	Outputs 7-8	Slat angle (0-100%)	1 byte	C	R	W	-
	65	Outputs 7-8	Position in % indication	1 byte	C	R	-	T
	66	Outputs 7-8	Slat angle indication in %	1 byte	C	R	-	T
	67	Outputs 7-8	Upper position reached	1 bit	C	R	-	T
	68	Outputs 7-8	Lower position reached	1 bit	C	R	-	T
	69	Outputs 7-8	Priority	2 bit	C	R	W	-
	70	Outputs 7-8	Status indication priority	1 bit	C	R	-	T
	71	Outputs 7-8	Scene	1 byte	C	R	W	-
	72	Outputs 7-8	Alarm 1	1 bit	C	R	W	-
	73	Outputs 7-8	Alarm 2	1 bit	C	R	W	-
	74	Outputs 7-8	Alarm 3	1 bit	C	R	W	-
	75	Outputs 7-8	Position in % automatic control	1 byte	C	R	W	-
	76	Outputs 7-8	Slat angle in % automatic control	1 byte	C	R	W	-
	77	Outputs 7-8	Automatic control deactivation	1 bit	C	R	W	-
	78	Outputs 7-8	Automatic control deactivation status	1 bit	C	R	-	T

	Number	Name	Function of the object	Length	C	R	W	T
	80	Outputs 9-10	Up/down	1 bit	C	R	W	-
	81	Outputs 9-10	Step/stop (short press)	1 bit	C	R	W	-
	82	Outputs 9-10	Stop (Short press)	1 bit	C	R	W	-
	83	Outputs 9-10	Position in %	1 byte	C	R	W	-
	84	Outputs 9-10	Slat angle (0-100%)	1 byte	C	R	W	-
	85	Outputs 9-10	Position in % indication	1 byte	C	R	-	T
	86	Outputs 9-10	Slat angle indication in %	1 byte	C	R	-	T
	87	Outputs 9-10	Upper position reached	1 bit	C	R	-	T
	88	Outputs 9-10	Lower position reached	2 bit	C	R	-	T
	89	Outputs 9-10	Priority	2 bit	C	R	W	-
	90	Outputs 9-10	Status indication priority	1 bit	C	R	-	T
	91	Outputs 9-10	Scene	1 byte	C	R	W	-
	92	Outputs 9-10	Alarm 1	1 bit	C	R	W	-
	93	Outputs 9-10	Alarm 2	1 bit	C	R	W	-
	94	Outputs 9-10	Alarm 3	1 bit	C	R	W	-
	95	Outputs 9-10	Position in % automatic control	1 byte	C	R	W	-
	96	Outputs 9-10	Slat angle in % automatic control	1 byte	C	R	W	-
	97	Outputs 9-10	Automatic control deactivation	1 bit	C	R	W	-
	98	Outputs 9-10	Automatic control deactivation status	1 bit	C	R	-	T

Note: For devices with additional outputs, object designation is identical. Only the object number differs.

3.2.2.1 Control

No.	Name	Function of the object	Data type	Flags
0, 20, 40, 60, 80	Output x-y	Up/down	1 bit - 1.008 DPT_UpDown	C, R, W
<p>These objects are always activated. It is used to control the shutter or blind in connection with the value that is sent on the KNX bus.</p> <p>Object value:</p> <ul style="list-style-type: none"> - If the object receives value "0", the shutter or blind moves to the upper position. - If the object receives value "1", the shutter or blind moves to the lower position. <p>For further information, see: Function selection.</p>				

No.	Name	Function of the object	Data type	Flags
1, 21, 41, 61, 81	Output x-y	Step/stop (short press)	1 bit - 1.007 DPT_Step	C, R, W
<p>This object is activated when the Closing type for channel x setting has the value Shutter and blind. It is used to stop the movement of the shutter or blind or the tilting of the slats according to the value that is sent on the KNX bus.</p> <p>Object value:</p> <ul style="list-style-type: none"> - Regardless of which value (0 or 1) is sent to this object, the movement of the shutter or blind will be stopped. - If the object receives the value "0", the slats will be opened by one slat step. - If the object receives the value "1", the slats will be closed by one slat step. <p>For further information, see: Function selection.</p>				

No.	Name	Function of the object	Data type	Flags
2, 22, 42, 62, 82	Output x-y	Stop (Short press)	1 bit - 1.017 DPT_Trigger	C, R, W

These objects are always activated. It is only used to stop the vertical movements of the shutter or blind according to the value sent on the KNX bus.

Object value:

- Regardless of which value (0 or 1) is sent to this object, the movement of the shutter or blind will be stopped.

For further information, see: [Function selection](#).

No.	Name	Function of the object	Data type	Flags
3, 23, 43, 63, 83	Output x-y	Position in %	1 byte - 5.001 DPT_Scaling	C, R, W

These objects are always activated. It is used for positioning the shutter or blind at the desired height, in response to the value sent on the KNX bus.

On the blind, the slats have the same tilt after reaching the same position as they had before the movement.
If a telegram is received during the movement of the shutter or blind, the shutter will be positioned at the desired height after the originally requested position has been reached.

Object value: 0 to 255

- 0 (0%): Upper position
- 255 (100%): Lower position

For further information, see: [Function selection](#).

No.	Name	Function of the object	Data type	Flags
4, 24, 44, 64, 84	Output x-y	Slat angle in %	1 byte - 5.001 DPT_Scaling	C, R, W

This object is activated when the **Closing type for channel x** setting has the value **Shutter and blind**.
It is used to position the shutter or blind in response to the value that is sent on the KNX bus.

Object value: 0 to 255

- 0 (0%): Slats open
- 255 (100%): Slats closed

For further information, see: [Function selection](#).

3.2.2.2 Status indication

No.	Name	Function of the object	Data type	Flags
5, 25, 45, 65, 85	Output x-y	Position in % indication	1 byte - 5.001 DPT_Scaling	C, R, T
<p>This object is activated when the Position status parameter is active. This object allows the status of the position to be sent over the KNX bus. It is sent after the position of the blind or shutter has been achieved.</p> <p>Object value: 0 to 255</p> <ul style="list-style-type: none"> - 0 (0%): Upper position - 255 (100%): Lower position <p>This object is sent when there is a status change. For further information, see: Status indication.</p>				

No.	Name	Function of the object	Data type	Flags
6, 26, 46, 66, 86	Output x-y	Slat angle indication in %	1 byte - 5.001 DPT_Scaling	C, R, T
<p>This object is activated when the Slat angle status parameter is active. This object allows the status of the slat angle to be sent over the KNX bus. It is sent after the tilting of the blind has been achieved.</p> <p>Object value: 0 to 255</p> <ul style="list-style-type: none"> - 0 (0%): Slats open - 255 (100%): Slats closed <p>This object is sent when there is a status change. For further information, see: Status indication.</p>				

No.	Name	Function of the object	Data type	Flags
7, 27, 47, 67, 87	Output x-y	Upper position reached	1 bit - 1.002 DPT_Bool	C, R, T
<p>This object is activated when the Upper position reached parameter is active. This object is used to send the status of the upper position of the shutter or blind over the KNX bus. Object value:</p> <p>0 = Position not reached, 1 = Position reached</p> <ul style="list-style-type: none"> - If the upper position of the shutter or blind is not reached, a telegram is sent with a logic value of "0" on the KNX bus. - If the upper position of the shutter or blind is reached, a telegram is sent with a logic value of "1" on the KNX bus. <p>This object is sent when there is a status change. For further information, see: Status indication.</p>				

No.	Name	Function of the object	Data type	Flags
8, 28, 48, 68, 88	Output x-y	Lower position reached	1 bit - 1.002 DPT_Bool	C, R, T
<p>This object is activated when the Lower position reached parameter is active. This object is used to send the status of the lower position of the shutter or blind over the KNX bus. Object value:</p> <p>0 = Position not reached, 1 = Position reached</p> <ul style="list-style-type: none"> - If the lower position of the shutter or blind is not reached, a telegram is sent with a logic value of "0" on the KNX bus. - If the lower position of the shutter or blind is reached, a telegram is sent with a logic value of "1" on the KNX bus. <p>This object is sent when there is a status change. For further information, see: Status indication.</p>				

3.2.2.3 Priority

No.	Name	Function of the object	Data type	Flags																									
9, 29, 49, 69, 89	Output x-y	Priority	2 bit - 2.002 DPT_Bool_Control	C, R, W																									
<p>This object is activated if the Priority parameter is active. The status of the output contact is determined directly by this object. Details on the format of the object are given below.</p> <table border="1" style="margin-left: auto; margin-right: auto;"> <thead> <tr> <th colspan="3">Telegram received by the priority operation object</th> <th rowspan="3">Output behaviour</th> </tr> <tr> <th rowspan="2">Hexadecimal Value</th> <th colspan="2">Binary Value</th> </tr> <tr> <th>Bit 1 (MSB)</th> <th>Bit 0 (LSB)</th> </tr> </thead> <tbody> <tr> <td>00</td> <td>0</td> <td>0</td> <td>End of the priority</td> </tr> <tr> <td>01</td> <td>0</td> <td>1</td> <td>End of the priority</td> </tr> <tr> <td>02</td> <td>1</td> <td>0</td> <td>Priority up</td> </tr> <tr> <td>03</td> <td>1</td> <td>1</td> <td>Priority down</td> </tr> </tbody> </table> <p>The first bit of this object (Bit 0) determines the status of the output contact, which should be priority controlled. The second bit activates or deactivates the Priority.</p> <p>For further information, see: Priority.</p>					Telegram received by the priority operation object			Output behaviour	Hexadecimal Value	Binary Value		Bit 1 (MSB)	Bit 0 (LSB)	00	0	0	End of the priority	01	0	1	End of the priority	02	1	0	Priority up	03	1	1	Priority down
Telegram received by the priority operation object			Output behaviour																										
Hexadecimal Value	Binary Value																												
	Bit 1 (MSB)	Bit 0 (LSB)																											
00	0	0	End of the priority																										
01	0	1	End of the priority																										
02	1	0	Priority up																										
03	1	1	Priority down																										

No.	Name	Function of the object	Data type	Flags
10, 30, 50, 70, 90	Output x-y	Status indication priority	1 bit - 1.011 DPT_State	C, R, T
<p>This object is activated if the Priority parameter is active. This object allows the status of the Priority to be sent from the device on the KNX bus.</p> <p>Object value:</p> <p>0 = Not forced, 1 = Forced:</p> <ul style="list-style-type: none"> - If Priority is deactivated, a telegram is sent with logic value 0. - If Priority is activated, a telegram is sent with logic value 1. <p>This object is sent when there is a status change. For further information, see: Priority.</p>				

3.2.2.4 Scene

No.	Name	Function of the object	Data type	Flags
8, 48, 88, 128, 168	Output x-y	Scene	1 byte - 18.001 DPT_SceneNumber	C, R, W

This object is activated when the **Scene** parameter is active.
 This object is used to recall or save a scene.
 Details on the format of the object are given below.

7	6	5	4	3	2	1	0
Learning	Not used	Scene number					

- Bit 7: 0: The scene is called
1: The scene is saved.
- Bit 6: Not used.
- Bit 5: Scene numbers from 0 (Scene 1) to 63 (Scene 64).

For further information, see: [Scene](#).

3.2.2.5 Alarm

No.	Name	Function of the object	Data type	Flags
12, 32, 52, 72, 92	Output x-y	Alarm 1	1 bit - 1.005 DPT_Alarm	C, R, W

This object is only visible if the **Alarm** parameter has the following value: Alarm 1 or Alarm 1 > Alarm 2 or Alarm 1 > Alarm 2 > Alarm 3.

This object is used to switch the output back to the predefined settings.

Object value:

- If the object receives the value 0, the alarm is not activated.
- -If the object receives the value 1, the alarm is activated.

For further information, see: [Alarm](#).

No.	Name	Function of the object	Data type	Flags
13, 33, 53, 73, 93	Output x-y	Alarm 2	1 bit - 1.005 DPT_Alarm	C, R, W

This object is only visible if the **Alarm** parameter has the following value: Alarm 1 > Alarm 2 or Alarm 1 > Alarm 2 > Alarm 3.

This object is used to switch the output back to the predefined settings.

Object value:

- If the object receives the value 0, the alarm is not activated.
- -If the object receives the value 1, the alarm is activated.

For further information, see: [Alarm](#).

No.	Name	Function of the object	Data type	Flags
14, 34, 54, 74, 94	Output x-y	Alarm 3	1 bit - 1.005 DPT_Alarm	C, R, W
<p>This object is only visible if the Alarm parameter has the following value: Alarm 1 > Alarm 2 > Alarm 3.</p> <p>This object is used to switch the output back to the predefined settings.</p> <p>Object value:</p> <ul style="list-style-type: none"> - If the object receives the value 0, the alarm is not activated. - -If the object receives the value 1, the alarm is activated. <p>For further information, see: Alarm.</p>				

3.2.2.6 Position in % automatic control

No.	Name	Function of the object	Data type	Flags
15, 35, 55, 75, 95	Output x-y	Position in % automatic control	1 byte - 5.001 DPT_Scaling	C, R, W
<p>This object is activated when the Automatic control parameter is active. It is used for positioning the shutter or blind at the desired height, in response to the value sent on the KNX bus.</p> <p>Object value: 0 to 255</p> <ul style="list-style-type: none"> - 0 (0%): Upper position - 255 (100%): Lower position <p>For further information, see: Automatic control.</p>				

3.2.2.7 Slat angle in % automatic control

No.	Name	Function of the object	Data type	Flags
16, 36, 56, 76, 96	Output x-y	Slat angle in % automatic control	1 byte - 5.001 DPT_Scaling	C, R, W
<p>This object is activated when the Closing type has the value Shutter and blind and when the Automatic control parameter is active. It is used to position the shutter or blind in response to the value that is sent on the KNX bus.</p> <p>Object value: 0 to 255</p> <ul style="list-style-type: none"> - 0 (0%) : Slats open - 255 (100%): Slats closed <p>For further information, see: Automatic control.</p>				

3.2.2.8 Automatic control deactivation

No.	Name	Function of the object	Data type	Flags
17, 37, 57, 77, 97	Output x-y	Automatic control deactivation	1 bit - 1.003 DPT_Enable	C, R, W

This object is activated when the **Automatic control deactivation** parameter is active.
This object is used to activate the automatic control function.

Object value:

- If the object receives the value 0, the automatic control function is inactive.
- If the object receives the value 1, the automatic control function is active.

For further information, see: [Automatic control](#).

No.	Name	Function of the object	Data type	Flags
18, 38, 58, 78, 98	Output x-y	Automatic control deactivation status	1 bit - 1.003 DPT_Enable	C, R, T

This object is activated when the **Automatic control deactivation** parameter is active.
This object is used to send the status of the Automatic control deactivation function of the device on the KNX bus.

Object value:

- If the Automatic control deactivation function is deactivated, a telegram with a logical value "0" is sent.
- If the Automatic control deactivation function is activated, a telegram with a logical value "1" is sent.

This object is sent when there is a status change.

For further information, see: [Automatic control](#).

4. Programming by Easy Tool

The function of the different devices only differs in the number of outputs. For this reason, only one device or one output will ever be described.

4.1 Product overview

■ TXA 610: 10 switch actuator

Product view:

View of channels:

0 Input

10-fold output	
	TXA610 - 1 - 1 Housing - Lighting
	TXA610 - 1 - 2 Housing - Lighting
	TXA610 - 1 - 3 Housing - Lighting
	TXA610 - 1 - 4 Housing - Lighting
	TXA610 - 1 - 5 Housing - Lighting
	TXA610 - 1 - 6 Housing - Lighting
	TXA610 - 1 - 7 Housing - Lighting
	TXA610 - 1 - 8 Housing - Lighting
	TXA610 - 1 - 9 Housing - Lighting
	TXA610 - 1 - 10 Housing - Lighting

■ Product settings

This configuration window is used for general configuration of the device.

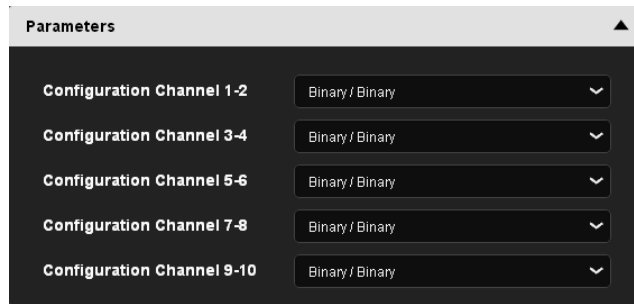

■ Pathway parameters

This parameter window is used to set the device outputs. These parameters are available individually for each output.

- ON/OFF

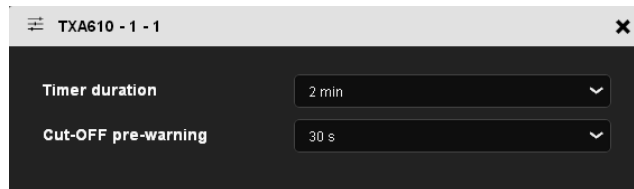

- Shutter/blind

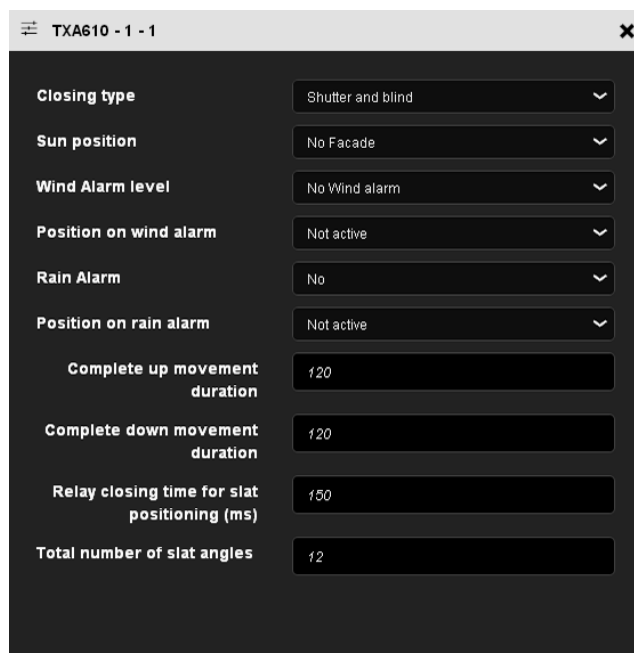

■ Available functionalities: ON/OFF

	ON		Automatic control ON
	OFF		Automatic control OFF
	ON/OFF		ON/OFF automatic control
	Toggle switch		Load shedding
	Timer		Scene
	Priority ON		Scene switch
	Priority OFF		Automatic control deactivation
	Priority ON push-button (1)		Deactivation Automatic control push-button (1)
	Priority OFF push-button (1)		

(1) This function is only available with push-button input products with LEDs indicating status.

Note: Dimming functions can also be linked with ON/OFF outputs. In this case, only the ON/OFF function is used. This procedure enables a same input to be connected to an ON/OFF output and to a dimming output.

	Increase dimming/ON
	Decrease dimming/OFF
	Increase/decrease dimming

■ Available functionalities: Shutter/blind

	Blinds up		Priority up
	Blinds down		Priority down
	Shutter UP		Priority up push-button (1)
	Shutter DOWN		Priority down push-button (1)
	Up/down		Wind alarm
	Down/up		Rain alarm
	Switch up		Automatic control shutter angle
	Down switch		Automatic control slat angle
	Up/stop		Automatic control shutter and slat angle
	Down/stop		Automatic control shutter position switch
	Shutter position		Automatic control inter slat angle
	Slat angle		Automatic control inter shutter and slat angle
	Shutter and slat angle		Scene
	Shutter angle switch		Scene switch
	Slat angle switch		Automatic control deactivation
	Shutter and slat angle switch		Deactivation Automatic control push-button (1)

(1) This function is only available with push-button input products with LEDs indicating status.

4.2 Closing type for the outputs

This configuration window is used to set the Closing type for the outputs.

The following parameters are available:

ON/OFF

- Each switching contact is used separately to switch a load.

Shutter

- Each pair of outputs constitutes a shutter and blind channel.

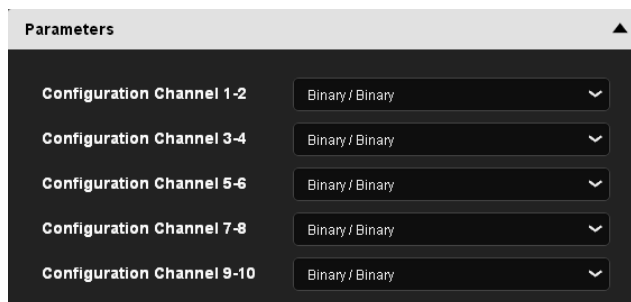

Parameter	Description	Value
Configuration path x-y	The outputs are used as ON/OFF switches. The outputs are used for shutters and blinds. One output for raising and one output for lowering.	TOR/TOR* Shutter

The assignment of the outputs is carried out following:

	ON/OFF	Shutter and blind
Configuration path 1-2	Output 1: ON/OFF Output 2: ON/OFF	Output 1-2: Shutter and blind
Configuration path 3-4	Output 3: ON/OFF Output 4: ON/OFF	Output 3-4: Shutter and blind
Configuration path 5-6	Output 5: ON/OFF Output 6: ON/OFF	Output 5-6: Shutter and blind
Configuration path 7-8	Output 7: ON/OFF Output 8: ON/OFF	Output 7-8: Shutter and blind
Configuration path 9-10	Output 9: ON/OFF Output 10: ON/OFF	Output 9-10: Shutter and blind

* Default value

4.3 Product functionalities

4.3.1 Functions of each switch actuator

4.3.1.1 ON/OFF

An output can be switched on or off using the ON/OFF function. The command can come from switches, buttons or other control inputs.

- **ON:** turns on the lighting circuit.

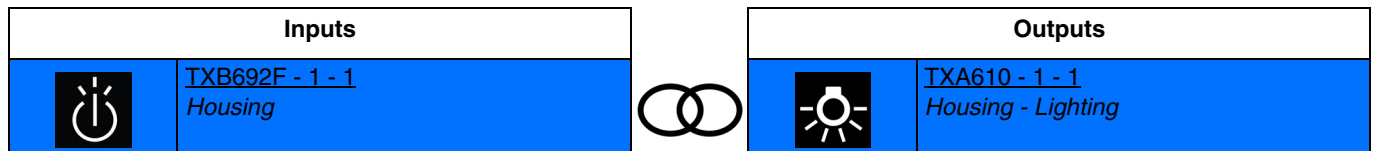

Closing input contact: turn on the light.
Opening input contact: no action.

- **OFF:** turns off the lighting circuit.

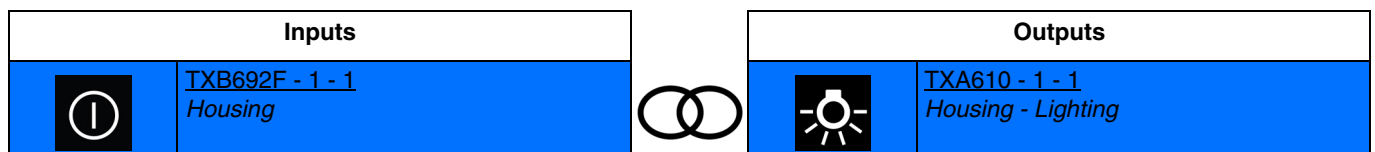

Closing input contact: turns off the light.
Opening input contact: no action.

- **ON/OFF:** turns on or shuts off the lighting circuit (switch).

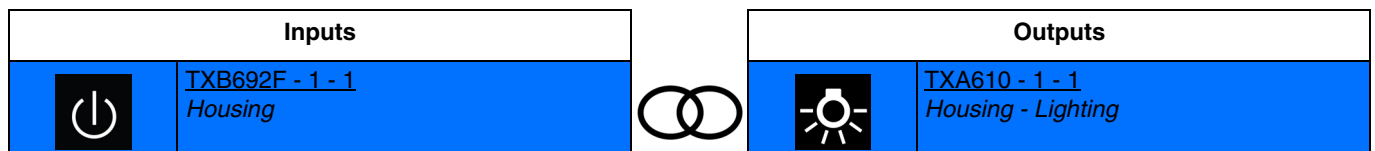

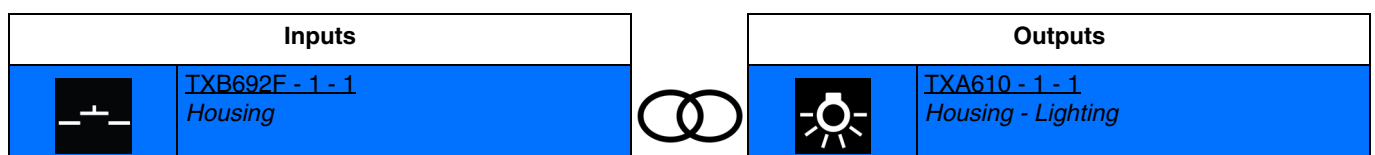

Closing input contact: turn on the light.
Opening input contact: turns off the light.

- **Toggle switch:** inverses the lighting circuit status.



Closing input contact: switch between turning the lights on and off.
Successive closings inverse output contact status each time.

Note: Dimming functions can also be linked with ON/OFF outputs. In this case, only the ON/OFF function is used. This procedure enables a same input to be connected to an ON/OFF output and to a dimming output.

	Increase dimming/ON
	Decrease dimming/OFF
	Increase/decrease dimming

4.3.1.2 Timer

The Timer function is used to switch on a lighting circuit for a programmable period. The timer may be interrupted before expiry of the delay time. A programmable Cut-OFF pre-warning announces the end of the delay time by a 1-second inversion of the output status.

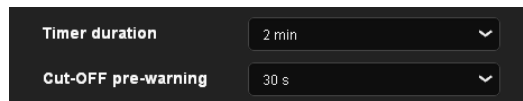

Parameter	Description	Value
Timer duration	This parameter determines the timer duration.	Not active, 1 s, 2 s, 3 s, 5 s, 10 s, 15 s, 20 s, 30 s, 45 s, 1 min, 1 min 15 s, 1 min 30 s, 2 min* , 2 min 30 s, 3 min, 5 min, 15 min, 20 min, 30 min, 1 h, 2 h, 3 h, 5 h, 12 h, 24 h

Parameter	Description	Value
Cut-OFF pre-warning	This parameter determines the lead time of the cut-OFF pre-warning.	Not active, 15 s, 30 s* , 1 min

Operating principle:

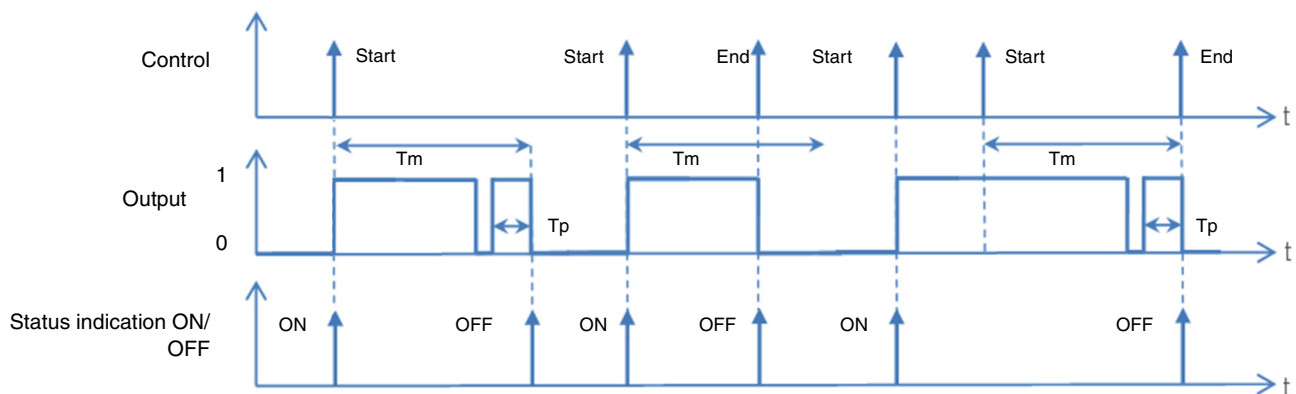

Tm: Timer duration
Tp: Pre-warning lead time

Note: If the lead time of the cut-OFF pre-warning is greater than the duration of the timer, the cut-OFF pre-warning is not triggered.

* Default value

■ The connection:

The Timer function is used to switch on a lighting circuit for a programmable period.

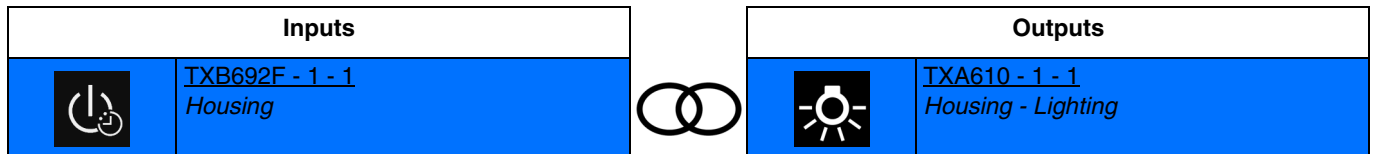

Brief closing of the input contact: timing function light switched on at the last saved level.

Timing function interruption:

Prolonged closing of the input contact: stop of timing delay in progress and light is turned off.

Note: At the time of connection, it is possible to define the timer duration.

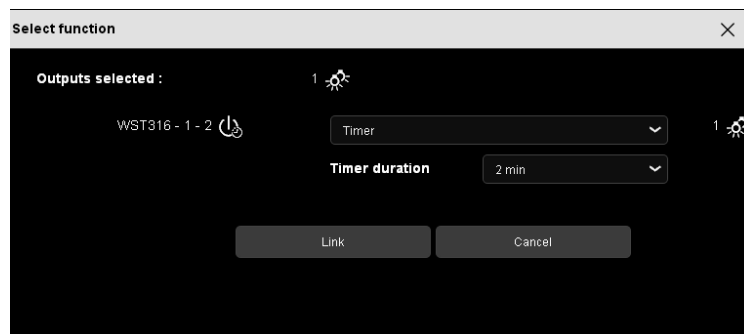

4.3.1.3 Priority

The Priority function is used to force the output into a defined state.

Priority: **Priority** > Basic function.

At the end of the priority, the output returns to the status it had before the priority (Memorisation function).

Operating principle:

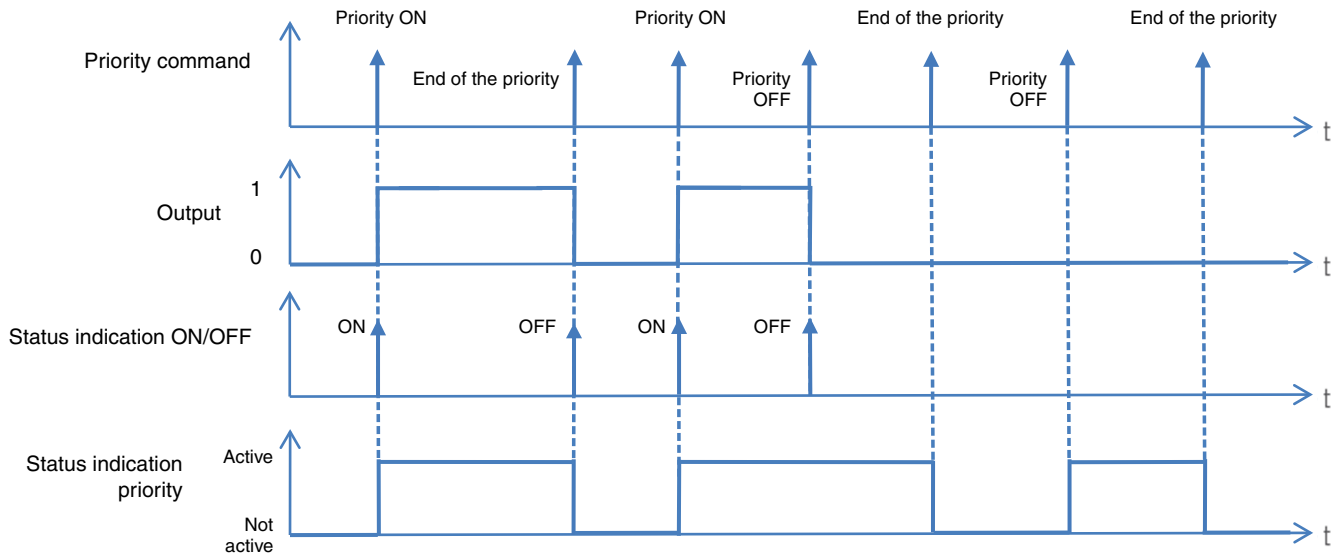

■ Links

- **Priority ON:** allows forcing and keeping the lighting circuit on.

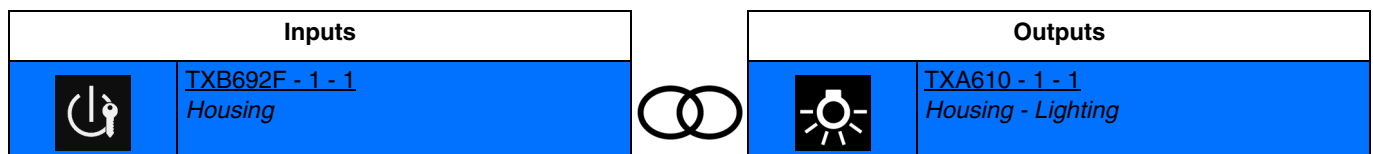

Closing input contact: turn on the light.
Opening input contact: end of the priority.

- **Priority ON push-button:** allows forcing and keeping the light circuit on using a push-button.

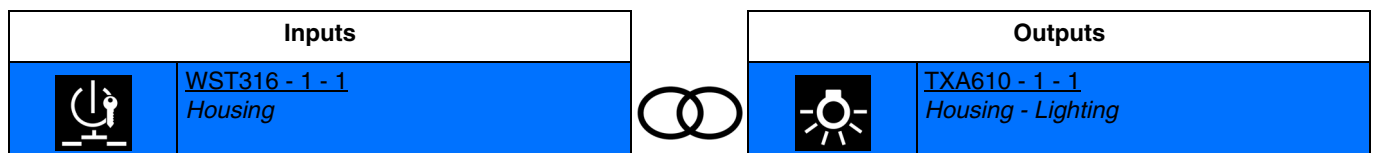

Closing input contact: turn on the light.
Opening input contact: no action.
A second closure of the input contact triggers the end of priority.

Note: This function is only available with push-button input products with LEDs indicating status.

- **Priority OFF:** allows forcing and keeping the lighting circuit off.

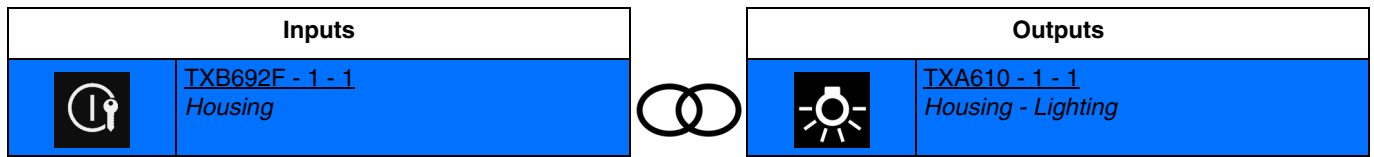

Closing input contact: turns off the light.
 Opening input contact: end of the priority.

- **Priority OFF push-button:** allows forcing and keeping the lighting circuit off using a push-button.

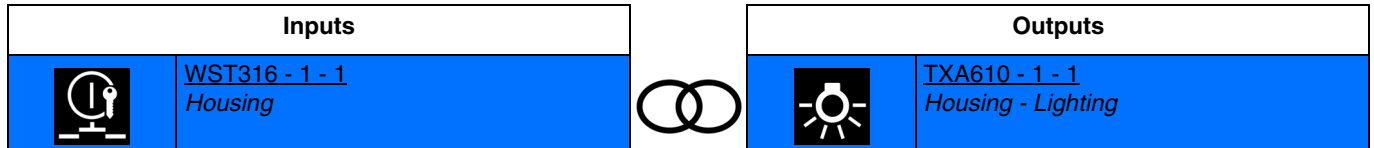

Closing input contact: turns off the light.
 Opening input contact: no action.
 A second closure of the input contact triggers the end of priority.

Note: This function is only available with push-button input products with LEDs indicating status.

4.3.1.4 Automatic control

The Automatic control function is used to command an output in parallel to the ON/OFF function. The two functions have the same level of priority. The last command received will act on the status of the output. An additional command object is used to activate or deactivate the Automatic control.

Example: when an output is controlled by a button and in parallel by an automatic control (timer, twilight switch, weather station, etc.) the automatic control can be deactivated for reasons of comfort (vacations, public holidays, etc.).

Operating principle:

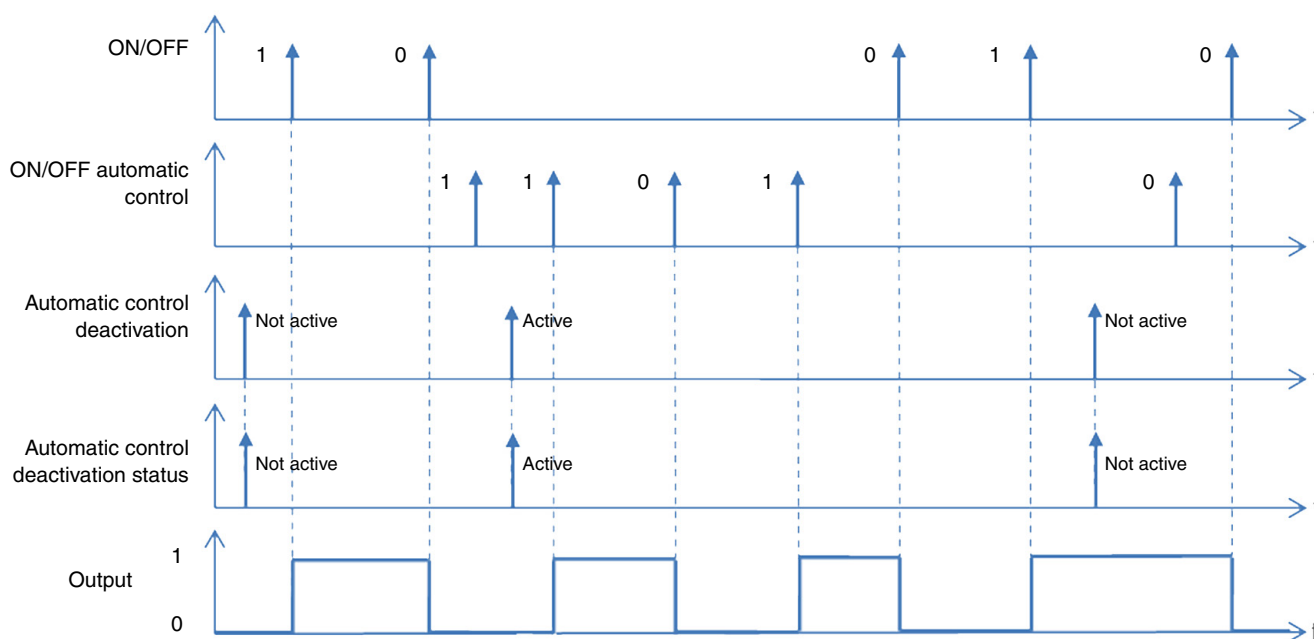

■ Links

- **Automatic control ON:** allows turning on the light circuit using automatic control.

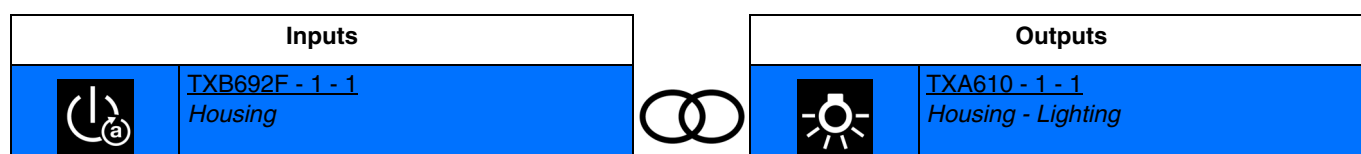

Closing input contact: turn on the light.
 Opening input contact: no action.

- **Automatic control OFF:** allows switching off the light circuit using automatic control.

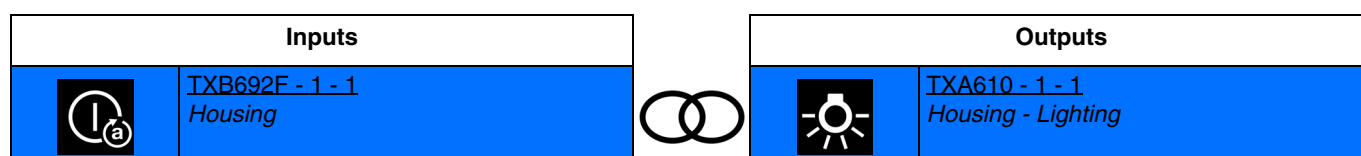

Closing input contact: turns off the light.
 Opening input contact: no action.

- **ON/OFF automatic control:** allows turning the lighting circuit on or off using automatic control (switch).

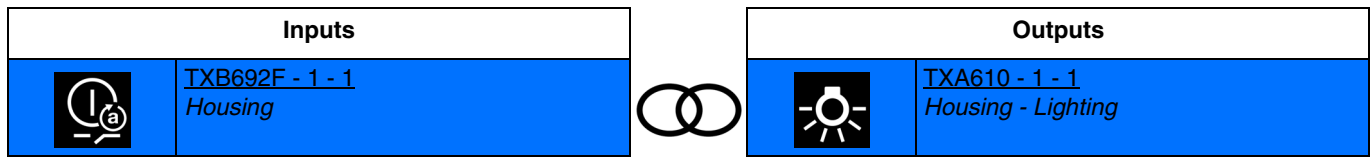

Closing input contact: turns on the light at the last saved level.
 Opening input contact: turns off the light.

- **Automatic control deactivation:** deactivates automatic control.

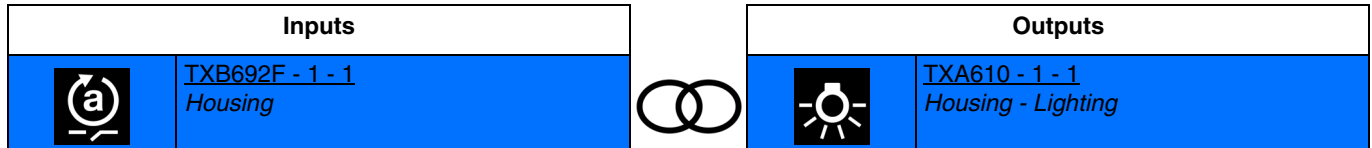

Closing input contact: deactivated automatic control.
 Opening input contact: activated automatic control.

- **Deactivation Automatic control push-button:** deactivates automatic control using a push-button.

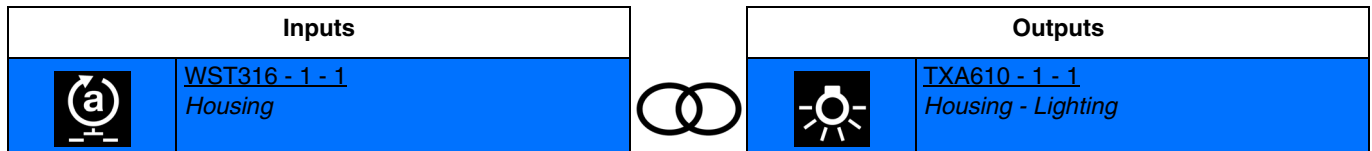

Closing input contact: deactivated automatic control.
 Opening input contact: no action.
 A second closing input contact triggers activation of the automatic control.

Note: This function is only available with push-button input products with LEDs indicating status.

4.3.1.5 Load shedding

The Load shedding function is used to force an output to OFF.

Priority: **Load shedding** > Priority > Basic function.

This command has the highest priority. No other command is taken into account if the mode is active. The status of the output is memorised but not applied. At the end of load shedding, the output is switched to the theoretical status without Load shedding (memorisation).

Example: Load shedding function

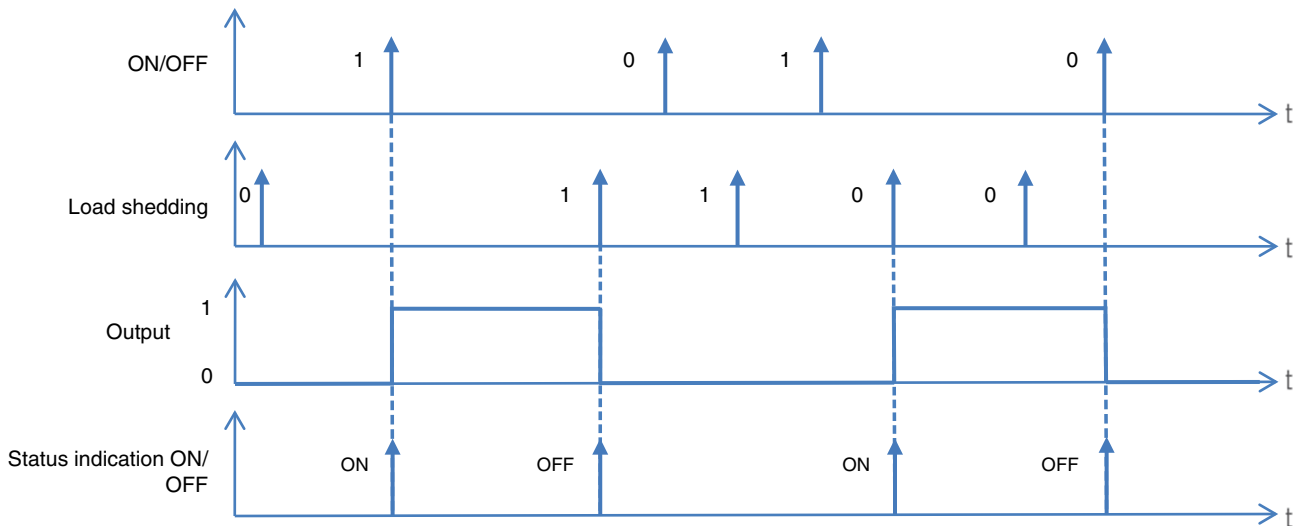

■ Links

- **Load shedding:** allows forcing an output to off.

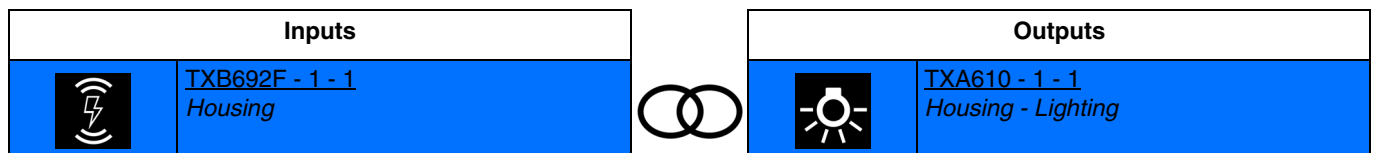

Closing input contact: priority of the output to off.

Opening input contact: return to output status before load shedding (memorisation).

4.3.1.6 Scene

The Scene function is used to switch groups of outputs into a configurable predefined state. Each output can be included in 8 different scenes.

Operating principle:

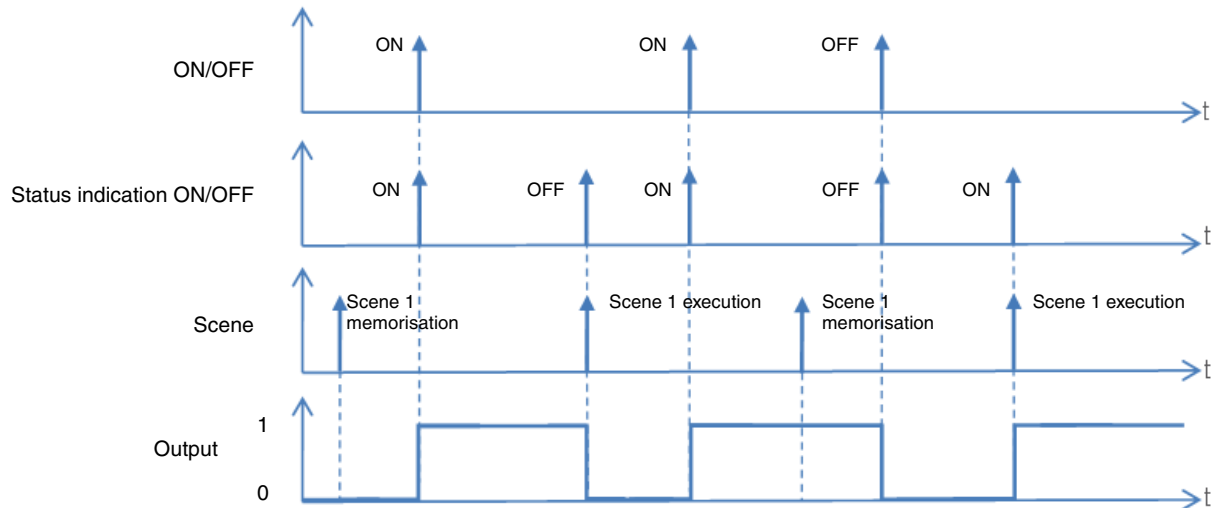

Learning and storing scenes

This process is used to change and store a scene. For example, by locally pressing the key in the room or by emission of the values from a visualization.

To access and store scenes, the following values must be sent:

Scene number	Access scene (Object value: 1 byte)	Store scene (Object value: 1 byte)
1-64	= Scene number - 1	= Scene number + 128
Examples		
1	0	128
2	1	129
3	2	130
...	...	
64	63	191

Here is the scene memorisation for local switches, for example.

- Activate scene by briefly pressing the transmitter that starts it.
- The outputs (lights, shutters, etc.) are set in the desired state using the usual local control devices (buttons, remote control, etc.).
- Memorise the status of the outputs with a press greater than 5 seconds long on the transmitter that starts the scene. The memorisation can be displayed by short-term activation of the outputs.

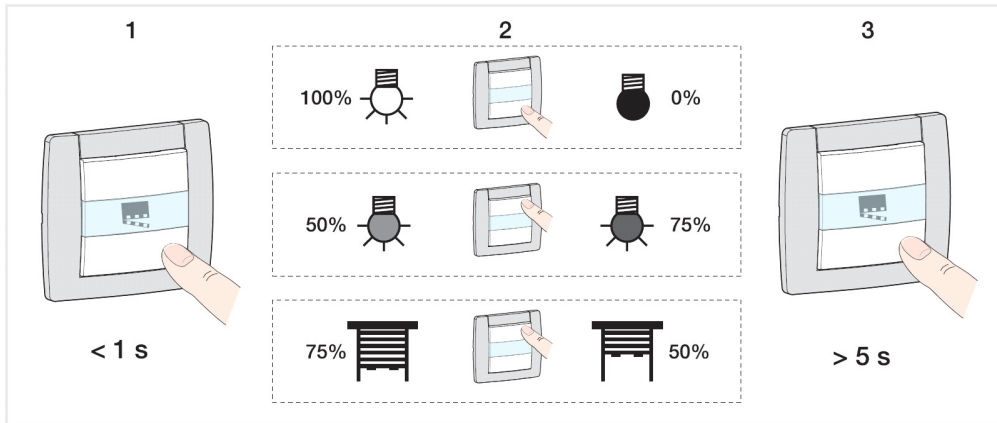

Product learning and memorisation

This procedure allows modifying a scene using a local action on the push buttons located on the front side of the product.

- Activate the scene using a short press on the ambiance push button, which triggers the scene,
- Set the product to manual mode and set the outputs to the desired status by pressing the push-buttons associated with the outputs,
- Return to Auto mode,
- Save the scene using a long push for more than 5 seconds on the push-button that triggers the scene,
- Memorisation is signalled by the inversion of the concerned output status for 3 sec.

■ Links

- **Scene:** the scene is activated by pressing the push-button.

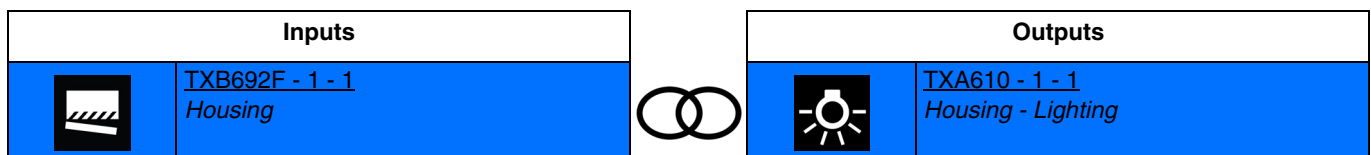

Closing input contact: scene activation.
Opening input contact: no action.

Note: At the time the connection is made, the scene number must be defined for the closing input contact.



- **Scene switch:** the scene is activated according to the closing or opening input contact.

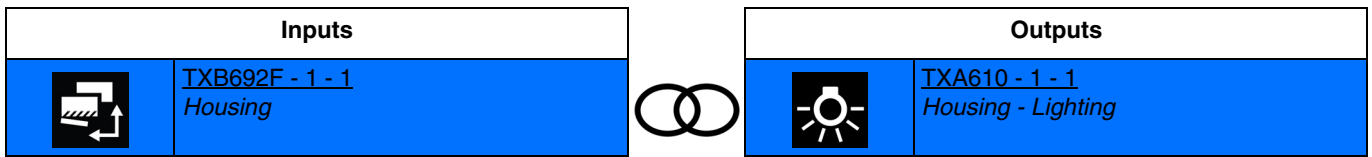

Closing input contact: scene activation 1.
 Opening input contact: scene activation 2.

Note: At the time the connection is made, the scene number must be defined for the closing and opening input contact.

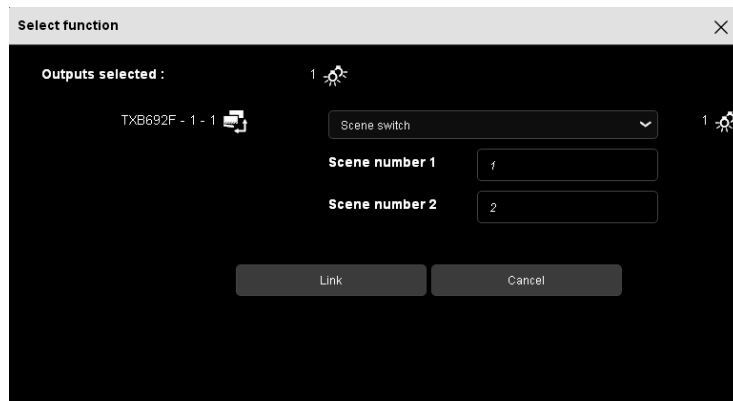

4.3.2 Functions for each shutter/blind output

Slat position for horizontal slats

The blind drive actuators have 2 limit position switches and can be run to a Sun protection position using a position setting in percent. The value of "0%" is used to control the upper position (i.e. Sun protection fully open) or is reported as a status.

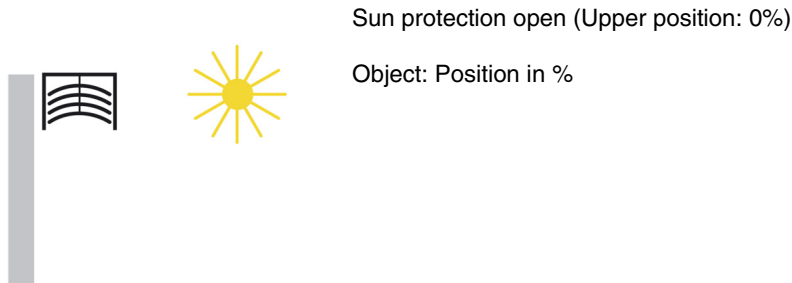

If the lower position is to be approached, then this will be sent to the blinds as Sun protection position 100% or on reaching the lower position (i.e. Sun protection completely closed). The position will be reported using this value. If a blind is run from the upper position, the slats initially tilt into an almost vertical position and then the sun protection runs with closed slats to the lower position.

When the blind is located at the lower position and the slats are fully closed, then this slat position is described as vertical and equal to 100%. Normally, however, fully closed slats have no exactly vertical position ($\alpha = 180^\circ$) but rather form a small angle with the vertical.

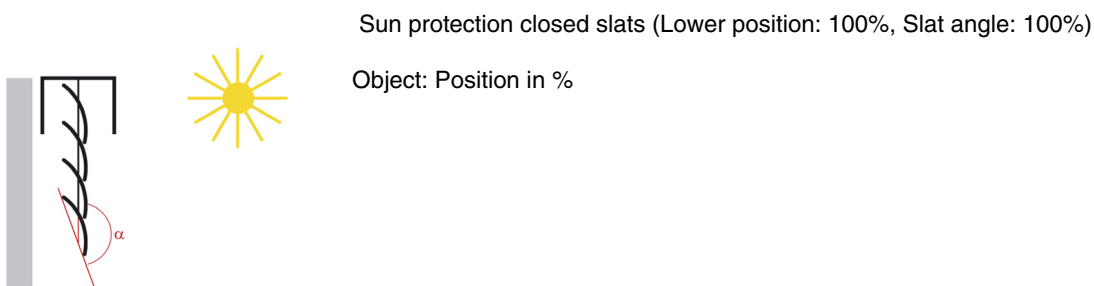

From their vertical position (completely closed, 100%) the slats can be adjusted to their horizontal position (fully open, 0% and $\alpha = 90^\circ$) The blind drive used thus determines whether this adjustment can be carried out using many small steps or whether it is only possible via a few large steps (As with most standard drives).



For standard blinds, the slats can be adjusted continuously to the horizontal position or until the slat adjustment ends and the raising of the blind begins. The slats then form an angle of between 0° and 90° with the vertical.

Slat position at the start of moving the blind (Up)

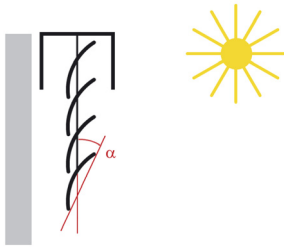

Object: Slat angle in %

Slat position for vertical slats

If an interior shade or privacy shield with vertical slats is controlled via a blind actuator, then the position in which the slats are fully open is controlled or reported as the 0% slat position. The slats then form an angle of 90° with the direction of travel from Shade fully open to Shade fully closed.

Fully opened vertical slats (Slat angle 0%)



Object: Slat angle in %

If the slats are fully closed, this position will be controlled and reported as slat position 100%. This is the position to which the shade is run from its side limit position in front of the window. The angle that the slats then form with the direction of movement is therefore a little > 0°.

Fully closed vertical slats (Slat angle 100%)

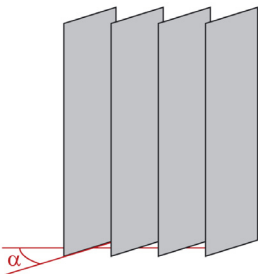

Object: Slat angle in %

If the shade is then driven back (i.e. opened), then the vertical slats are turned to a position that is somewhat smaller than 180°.

Vertical slats at the start of moving UP

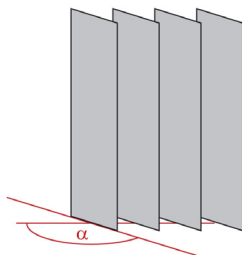

4.3.2.1 Pathway parameters

These parameters are available individually for each output (Pair).

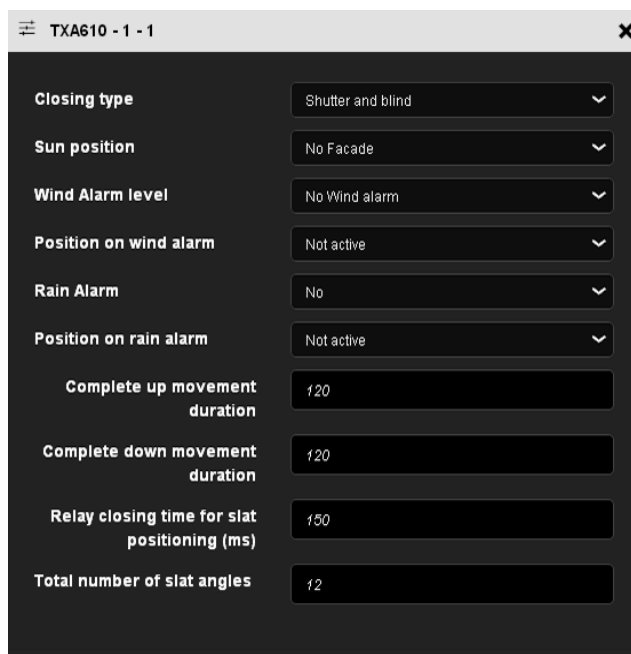

Parameter	Description	Value
Closing type	This parameter defines the operating mode used for the affected outputs. An operating mode of the shutter and blind type gives access to additional parameters to control the slat pitch.	Shutter Shutter and blind*

Parameter	Description	Value
Complete up movement duration	This parameter defines the time taken, during which the contact must be closed, to reach the upper position.	1... 120* ...500 s

Parameter	Description	Value
Complete down movement duration	This parameter defines the time taken, during which the contact must be closed, to reach the lower position.	1... 120* ...500 s

Parameter	Description	Value
Relay closing time for slat positioning (ms)	This parameter defines how long the contacts must be closed in order to perform an elementary angle step for the slats.	1... 150* ...2500 ms

Parameter	Description	Value
Total number of slat angles	This parameter defines the total number of elementary slat steps available for adjusting the slats from the inclined downwards position to be inclined upwards position.	1... 12* ...50

*Note: Before setting the **Total number of slat angles** parameter, it is essential to first set the closed contact duration for an elementary slat step.*

* Default value

4.3.2.2 Up/down

- **Blinds up:** allows to raise or stop a blind or tilt the blind slats.

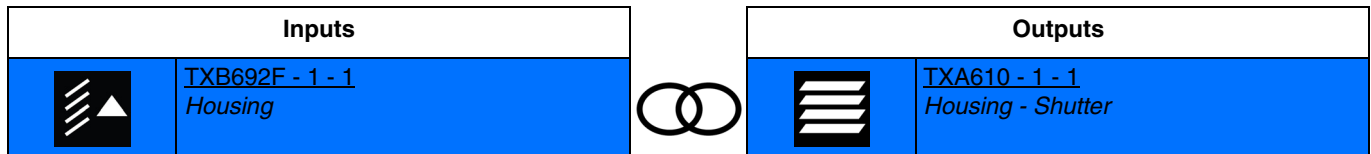

Brief closing of the input contact: brief closing of the raise input contact.
 Prolonged closing of the input contact: delayed closing of the raise output contact.
 Opening input contact: no action.

Note: If a brief input contact occurs during the delay, the output contact opens (stop function).

- **Blinds down:** allows to lower or stop a blind or tilt the blind blades.

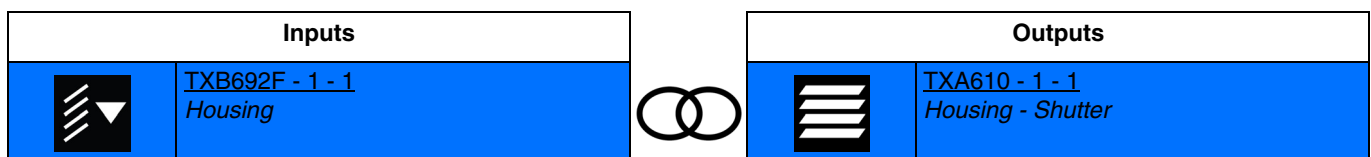

Brief closing of the input contact: brief closing of a lowering output contact.
 Prolonged closing of the input contact: delayed closing of the lowering output contact.
 Opening input contact: no action.

Note: If a brief input contact occurs during the delay, the output contact opens (stop function).

- **Shutter UP:** allows to raise or stop a rolling shutter.

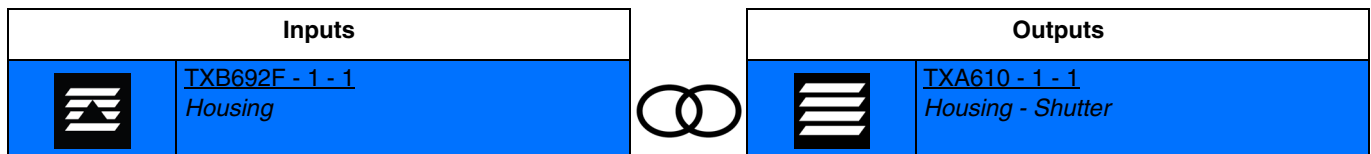

Prolonged closing of the input contact: delayed closing of the raise output contact.
 Opening input contact: no action.

Note: If a brief input contact occurs during the delay, the output contact opens (stop function).

- **Shutter DOWN:** allows to lower or stop a rolling shutter.

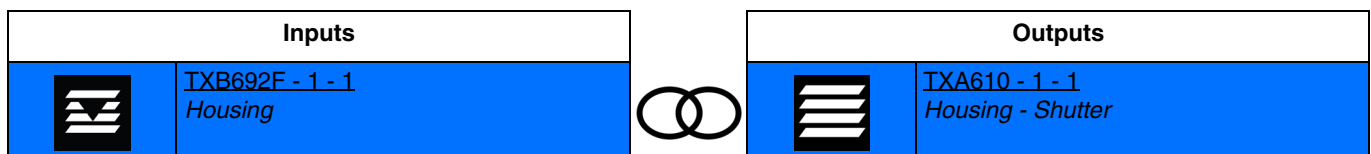

Prolonged closing of the input contact: delayed closing of the lowering output contact.
 Opening input contact: no action.

Note: If a brief input contact occurs during the delay, the output contact opens (stop function).

- **Up/down:** allows to raise or lower a rolling shutter or a blind using a switch.

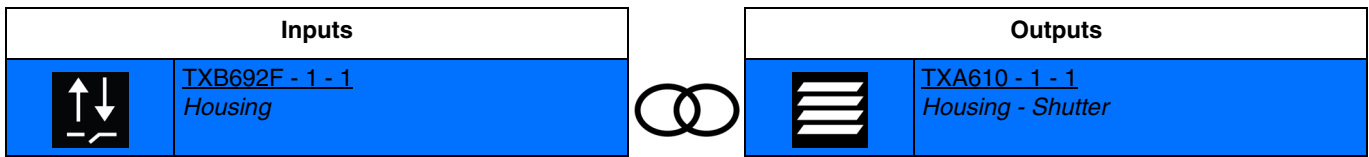

Closing input contact: delayed closing of the raise output contact.
 Opening input contact: delayed closing of the lowering output contact.

- **Down/up:** allows to raise or lower a rolling shutter or a blind using a switch.

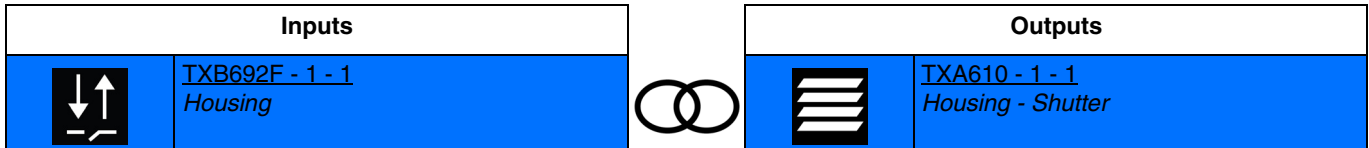

Closing input contact: delayed closing of the lowering output contact.
 Opening input contact: delayed closing of the raise output contact.

- **Switch up:** allows to raise a rolling shutter or a blind using a switch.

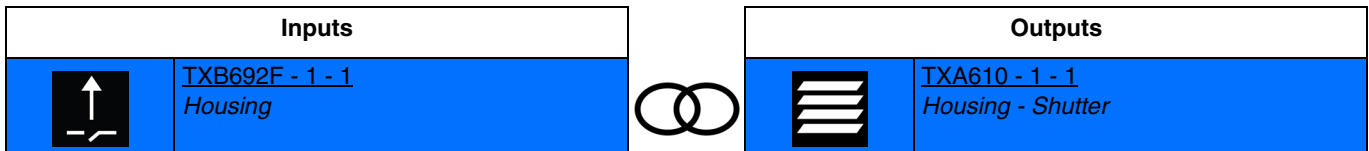

Closing input contact: delayed closing of the raise output contact.
 Opening input contact: no action.

- **Down switch:** allows to lower a rolling shutter or a blind using a switch.

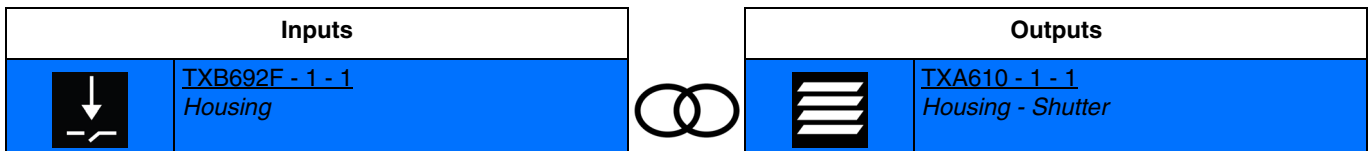

Closing input contact: delayed closing of the lowering output contact.
 Opening input contact: no action.

- **Up/stop:** allows to raise or stop a rolling shutter or a blind using a switch.

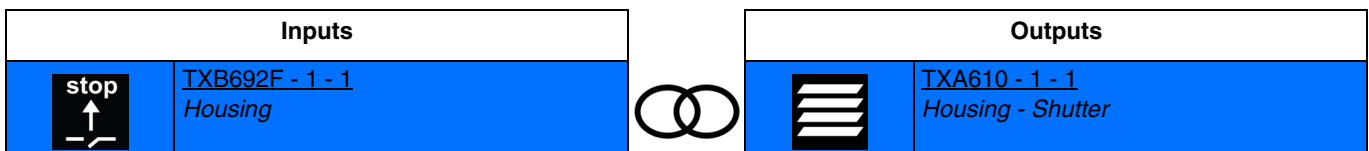

Closing input contact: delayed closing of the raise output contact.
 Opening input contact: opening an output contact (stop function).

- **Down/stop:** allows to lower or stop a rolling shutter or a blind using a switch.

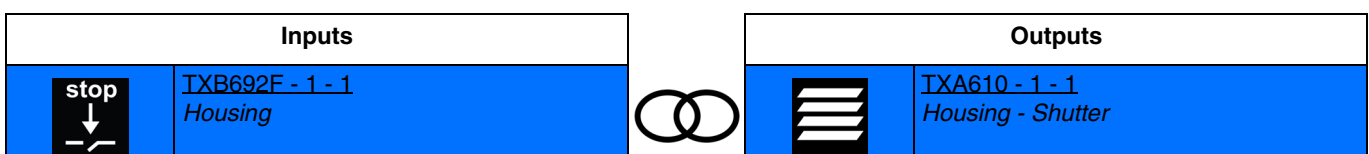

Closing input contact: delayed closing of the lowering output contact.
 Opening input contact: opening an output contact (stop function).

4.3.2.3 Shutter or blind angle

- **Shutter position:** allows to angle a rolling shutter or blind to the desired height according to a value in %.

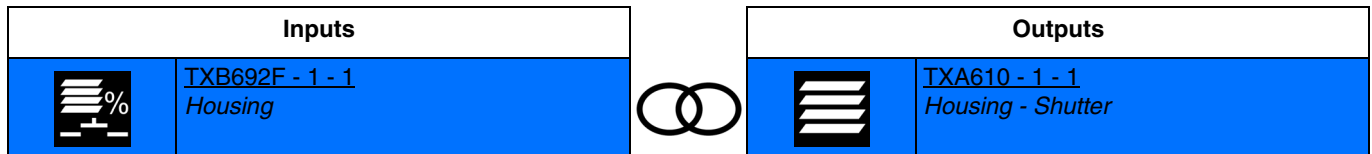

Closing input contact: delayed closing of output contacts for angling the shutter or blind.
 Opening input contact: no action.

Note: When the connection is made, the value in % of the shutter angle must be defined (0%: upper position, 100%: lower position).



- **Slat angle:** allows positioning shutter slats according to a value in %.

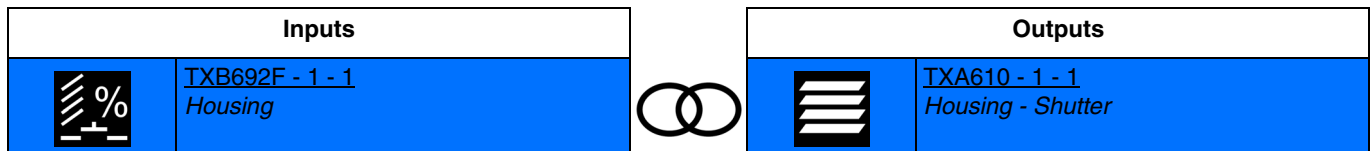

Closing input contact: delayed closing of output contacts for the shutter slat tilt.
 Opening input contact: no action.

Note: When the connection is made, the value in % of the shutter slat angle must be defined (0%: slats open, 100%: slats closed).

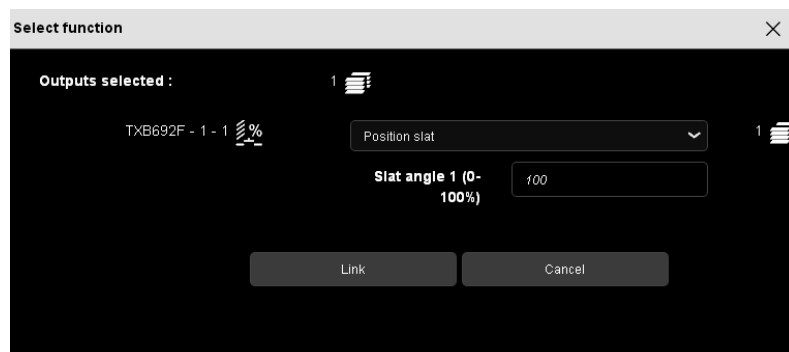

- **Shutter and slat angle:** allows positioning a rolling shutter or blind at the desired height and the blind slats according to a value in %.

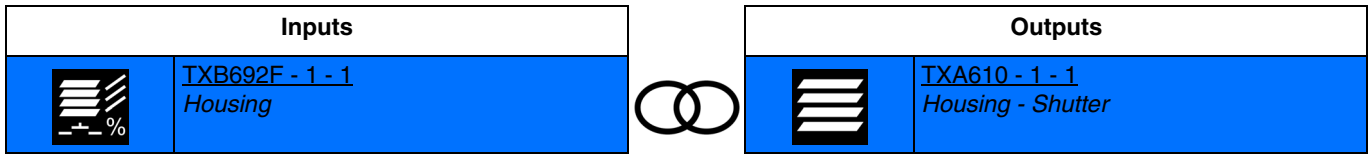

Closing input contact: delayed closing of output contacts for the shutter or blind angle and for the blind slat tilt.
 Opening input contact: no action.

Note: When the connection is made, the value in % for the shutter position must be defined (0%: high position, 100% low position) and the value in % of the blind slat position (0%: slats open, 100%: slats closed).



- **Shutter angle switch:** allows positioning a rolling shutter or blind at the desired height according to a value in % using a switch.

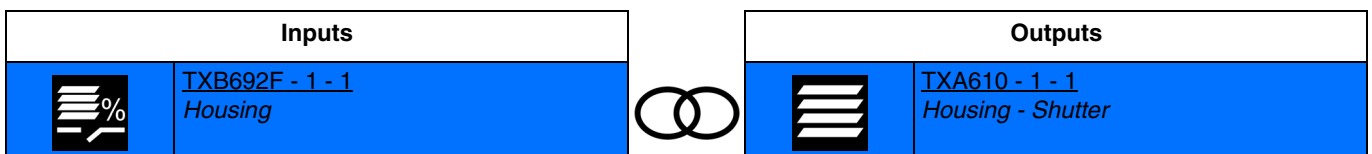

Closing input contact: delayed closing of output contacts for position 1 of the shutter or blind.
 Opening input contact: delayed closing of output contacts for position 2 of the shutter or blind.

Note: When the connection is made, values must be defined in % for shutter positions 1 and 2 (0%: upper position, 100%: lower position).

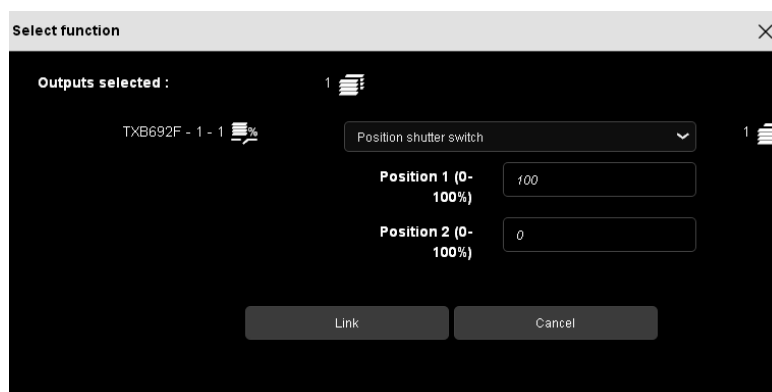

- **Slat angle switch:** allows positioning blind slates according to a value in % using a switch.

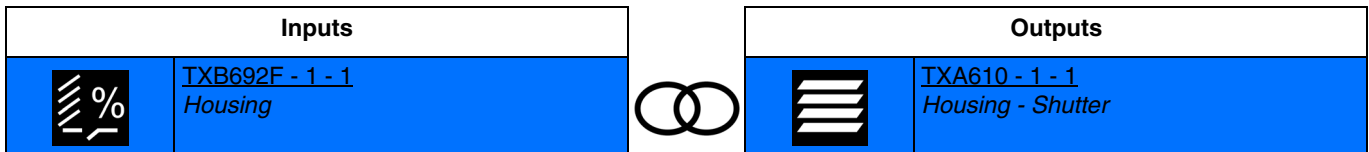

Closing input contact: delayed closing of output contacts for position 1 of the blind slats.
 Opening input contact: delayed closing of output contacts for position 2 of the blind slats.

Note: When the connection is made, values must be defined in % for blind slat positions 1 and 2 (0%: slats open, 100%: slats closed).

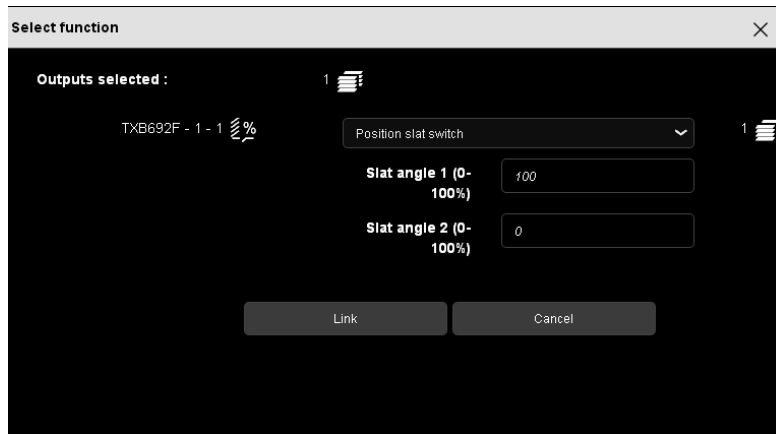

- **Shutter and slat angle switch:** allows positioning a rolling shutter or a blind at the desired height and the blind slates according to a value in % using a switch.

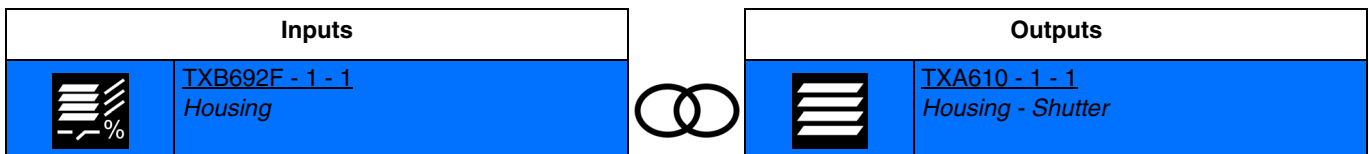

Closing input contact: delayed closing of output contacts for position 1 of the shutter or blind and for position 1 for blind slats.
 Opening input contact: delayed closing of output contacts for position 2 of the shutter or blind and for position 2 for blind slats.

Note: When the connection is made, values must be defined in % for shutter positions 1 and 2 (0%: high position, 100%: low position) and values in % for blind slats positions 1 and 2 (0%: slats open, 100%: slats closed).

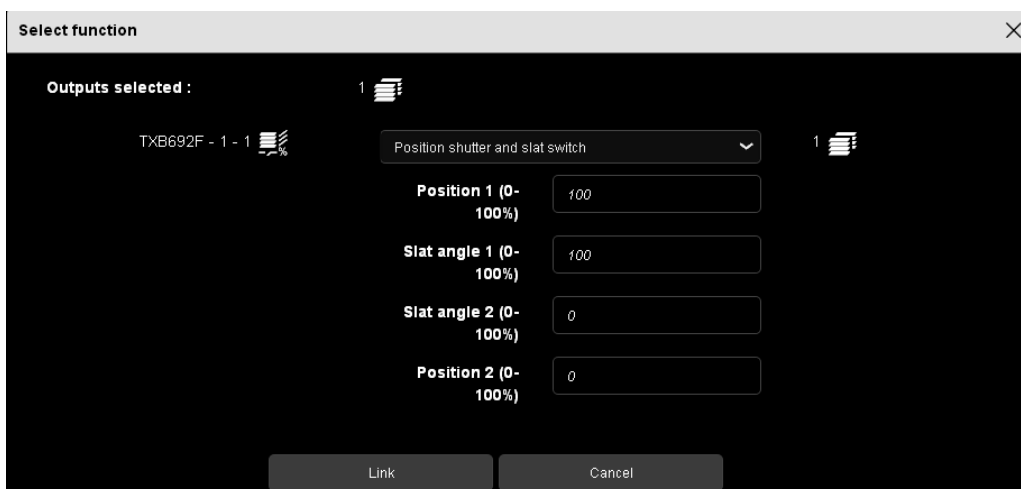

4.3.2.4 Priority

The Priority function is used to force the output into a defined state.

Priority: Alarm > **Priority** > Basic function.

At the end of the priority, the output returns to the status it had before the priority (Memorisation function).

Operating principle:

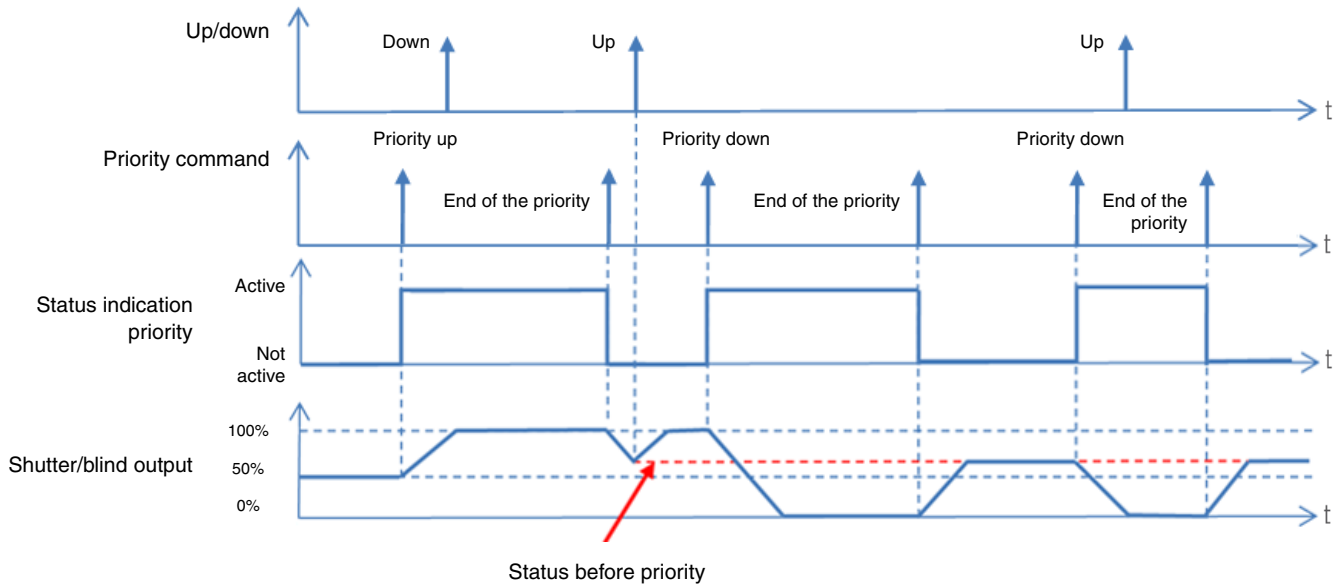

■ Links

- **Priority up:** allows forcing a rolling shutter or blind to raise.

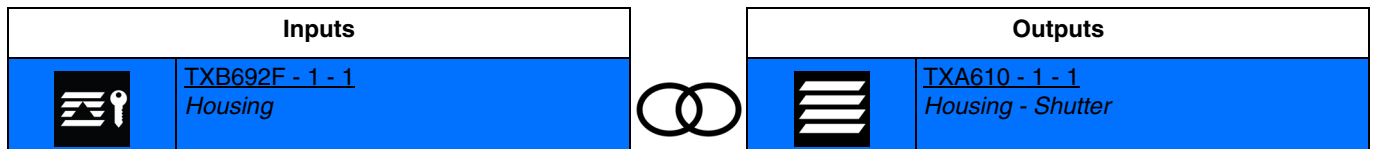

Closing input contact: activation priority and delayed closing of the raise output contact.

Opening input contact: end of the priority.

- **Priority up push-button:** allows forcing a rolling shutter or blind to raise using a push-button.

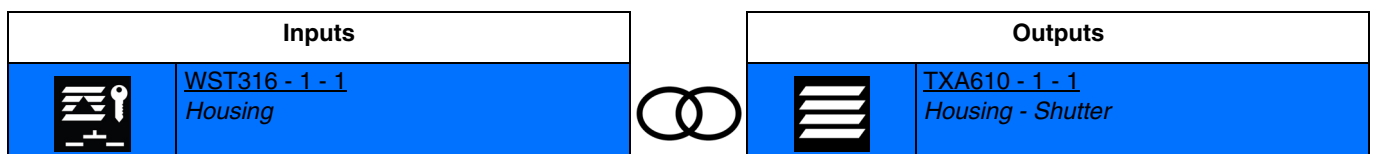

Closing input contact: activation priority and delayed closing of the raise output contact.

Opening input contact: no action.

A second closure of the input contact triggers the end of priority.

Note: This function is only available with push-button input products with LEDs indicating status.

- **Priority down:** allowing forcing a rolling shutter or blind to lower.

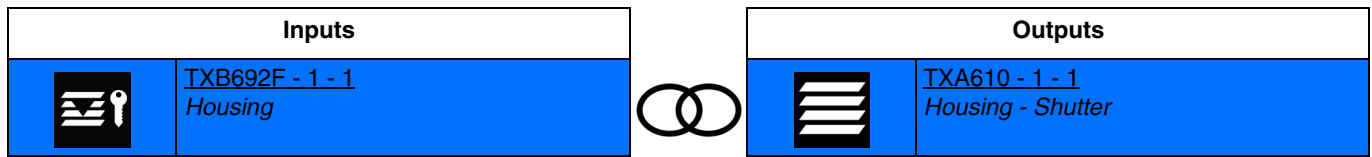

Closing input contact: activation of priority and delayed closing of the lowering output contact.
 Opening input contact: end of the priority.

- **Priority down push-button:** allows forcing a rolling shutter or blind to lower using a push-button.

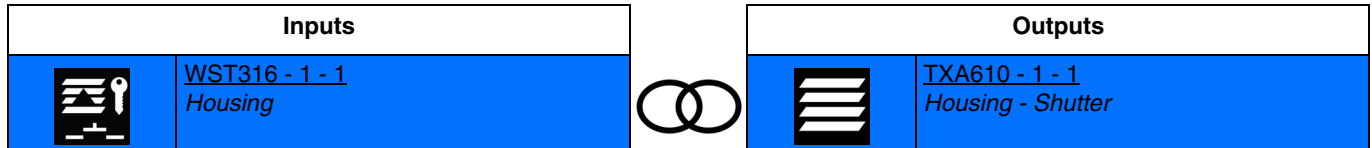

Closing input contact: activation of priority and delayed closing of the lowering output contact.
 Opening input contact: no action.

A second closure of the input contact triggers the end of priority.

Note: This function is only available with push-button input products with LEDs indicating status.

4.3.2.5 Alarm

With the Alarm function a shutter or blind can be positioned in a configurable predefined state.

Priority: **Alarm** > Priority > Basic function.

The alarm prevents any actuation until an alarm cancellation command has been received.

Up to 2 alarm functions are possible (Wind alarm > Rain alarm).

When an alarm appears, change in output status is defined by a setting (Up, Down, Unchanged position).

After the alarm, the shutter or blind takes up the position it would be in if no alarm had occurred.

Operating principle:

Example:

- Position on rain alarm: up.
- Position on wind alarm: down.

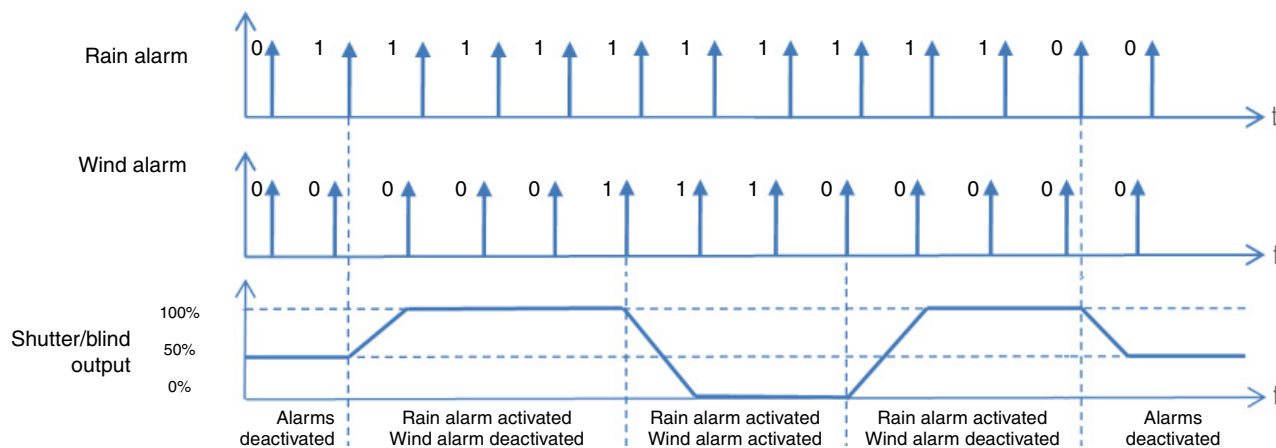

If several alarms triggered at the same time, the commands associated with the highest priority alarm are executed.

For the alarms, the connections are made in 2 ways:

- Classic connections: Alarm information is sent using an input product connected to the KNX bus. Therefore, information can come from any device other than KNX having a dry contact output.
- Automatic connections: Alarm information is sent directly to the KNX bus. In general, it comes from a weather station connected to the KNX bus. In this case, the connection is made through a simple configuration.

■ Links

- **Wind alarm:** allows to set the rolling shutter or blind in a defined position when the alarm is activated.

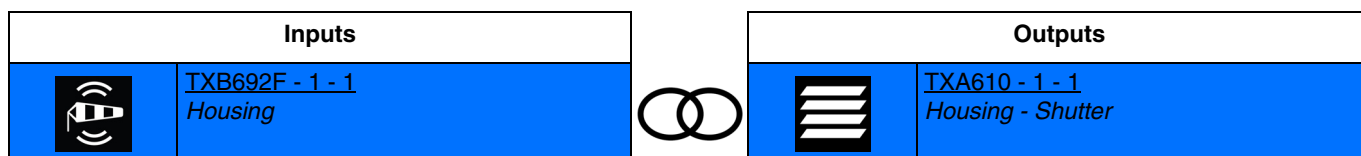

Closing input contact: wind alarm activation.

Opening input contact: alarm end.

The rolling shutter or blind angle is defined through a setting.

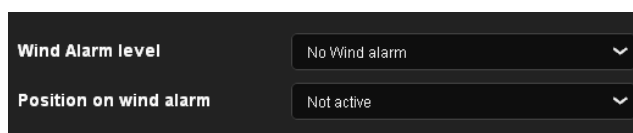

Parameter	Description	Value
Position on wind alarm	During the wind alarm, the shutter/blind output: Not changed Closes the Up contact Closes the down contact	Not active* Up Down

Note: The setting **Wind alarm level** is not taken into account with this type of connection.

- **Rain alarm:** allows to set the rolling shutter or blind in a defined position when the alarm is activated.

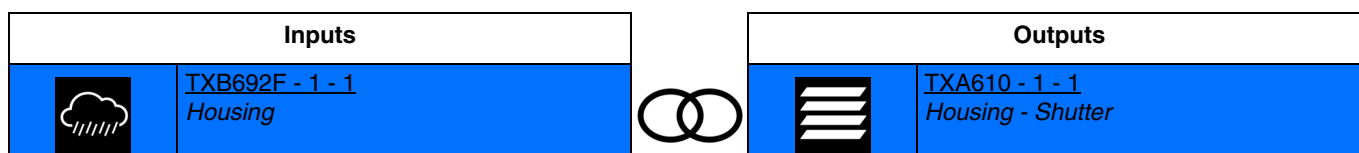

Closing input contact: rain alarm activation.
Opening input contact: alarm end.

The rolling shutter or blind angle is defined through a setting.

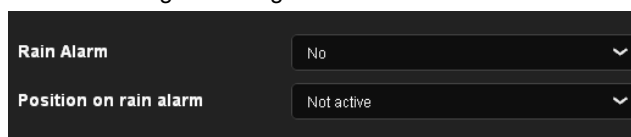

Parameter	Description	Value
Position on rain alarm	Defines the status of the shutter output on receipt of the rain alarm.	Not active* Up Down

Note: The setting **rain alarm** is not taken into account with this type of connection.

■ Automatic connections

This link is established depending on the configuration of products.

- **Wind alarm:** allows to set the rolling shutter or blind in a defined position when the alarm is activated.

For the wind alarm, please refer to the shutter configuration.

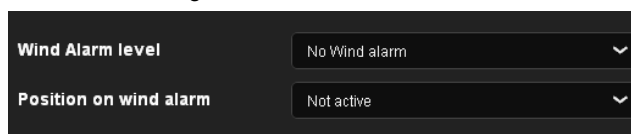

Parameter	Description	Value
Wind alarm stepping switch	Activates the shutter output on receipt of wind alarms 1, 2 or 3.	No wind alarm* Step 1 Step 2 Step 3

Wind alarm 1: The alarm is activated if the wind speed > 4 m/s (14.4km/h)
Wind alarm 2: The alarm is activated if the wind speed > 8 m/s (28.8km/h)
Wind alarm 3: The alarm is activated if the wind speed > 12 m/s (43.2km/h)

Note: Please refer to the weather station documentation for further information.

* Default value

Parameter	Description	Value
Position on wind alarm	During the wind alarm, the shutter/blind output: Not changed Closes the Up contact Closes the down contact	Not active* Up Down

- **Rain alarm:** allows to set the rolling shutter or blind in a defined position when the alarm is activated.

For the rain alarm, please see the shutter configuration.

Rain Alarm No

Position on rain alarm Not active

Parameter	Description	Value
Rain alarm	Activates the shutter output on receipt of the rain alarm.	Yes No*

Parameter	Description	Value
Position on rain alarm	Defines the status of the shutter output on receipt of the rain alarm.	Not active* Up Down

* Default value

4.3.2.6 Automatic control

The Automatic control function is used to control an output in parallel to the Up/Down or Slat tilt/stop function. The functions have the same level of priority. The last command received will act on the status of the output. An additional command object is used to activate or deactivate the Automatic control.

Example: when an output is controlled by a button and in parallel by an automatic control (timer, twilight switch, weather station, etc.) the automatic control can be deactivated for reasons of comfort (vacations, public holidays, etc.).

Operating principle:

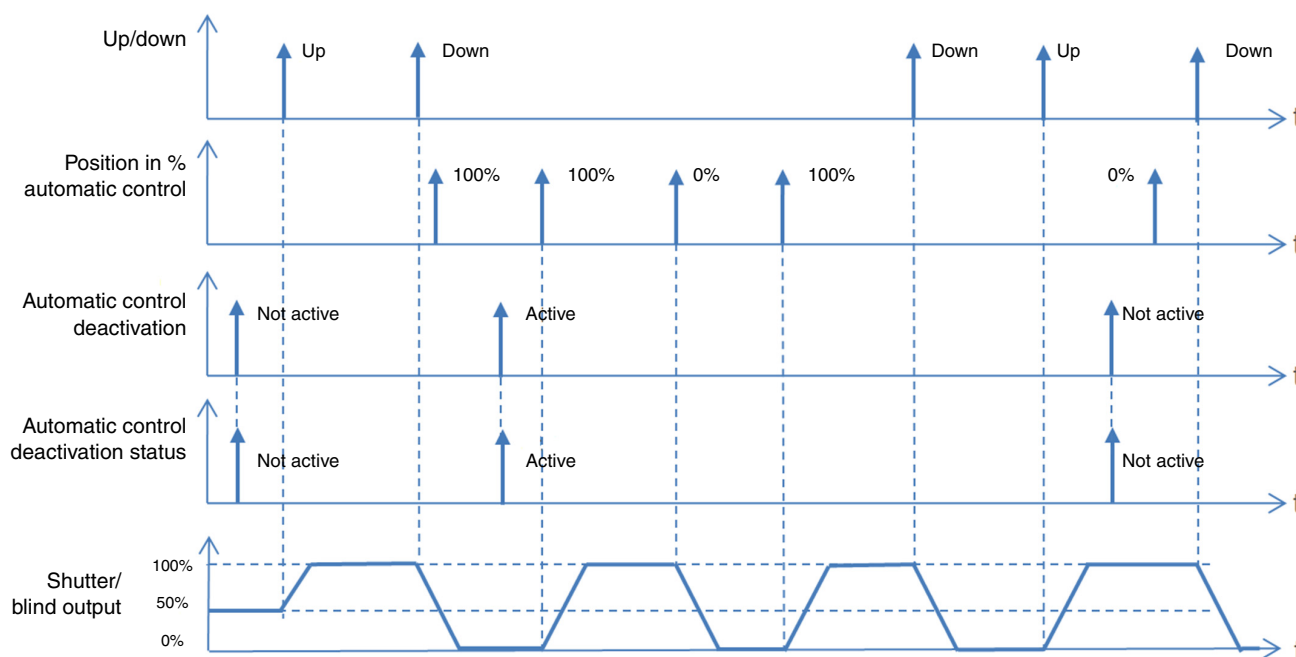

■ Links

- **Automatic control shutter angle:** allows positioning a rolling shutter or blind to the desired height according to a value in % using automatic control.

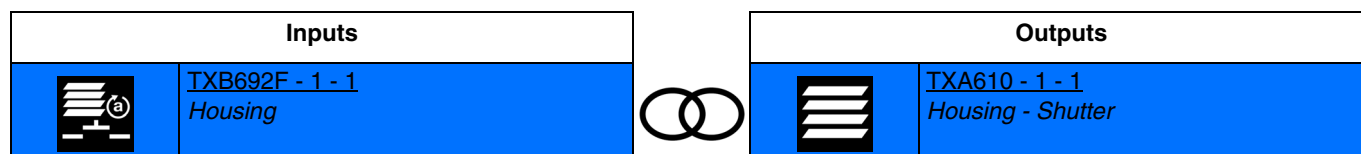

Closing input contact: delayed closing of output contacts for angling the shutter or blind.
Opening input contact: no action.

Note: When the connection is made, the value in % of the shutter angle must be defined (0%: upper position, 100%: lower position).

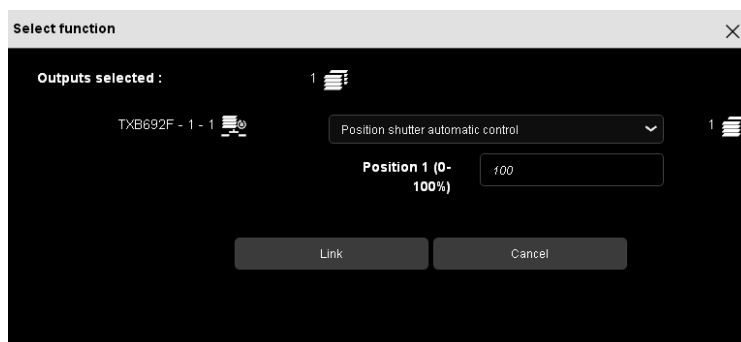

- **Automatic control slat angle:** Allows positioning blind slats according to a value in % using automatic control.

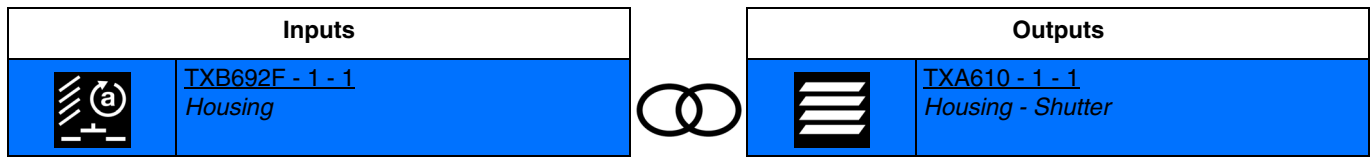

Closing input contact: delayed closing of output contacts for the shutter slat tilt.
 Opening input contact: no action.

Note: When the connection is made, the value in % of the shutter slat angle must be defined (0%: slats open, 100%: slats closed).



- **Automatic control shutter and slat angle:** allows positioning a rolling shutter or blind to the desired height and blind slats according to a value in % using automatic control.

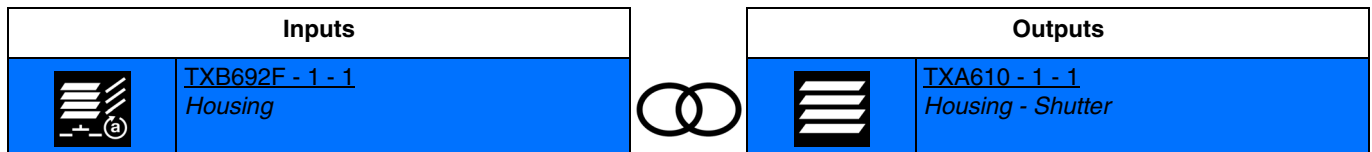

Closing input contact: delayed closing of output contacts for the shutter or blind angle and for the blind slat tilt.
 Opening input contact: no action.

Note: When the connection is made, the value in % for the shutter position must be defined (0%: high position, 100% low position) and the value in % of the blind slat position (0%: slats open, 100%: slats closed).

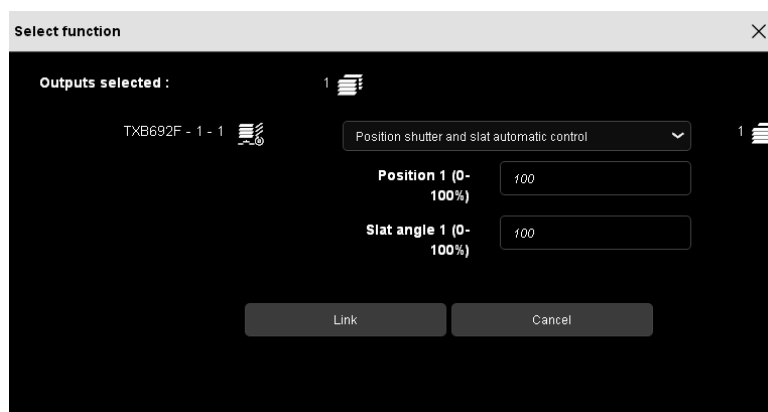

- **Automatic control shutter position switch:** allows positioning a rolling shutter or blind to the desired height according to a value in % using a switch and automatic control.

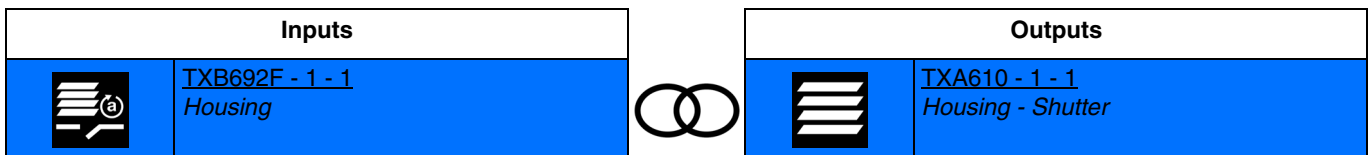

Closing input contact: delayed closing of output contacts for position 1 of the shutter or blind.
 Opening input contact: delayed closing of output contacts for position 2 of the shutter or blind.

Note: When the connection is made, values must be defined in % for shutter positions 1 and 2 (0%: upper position, 100%: lower position).

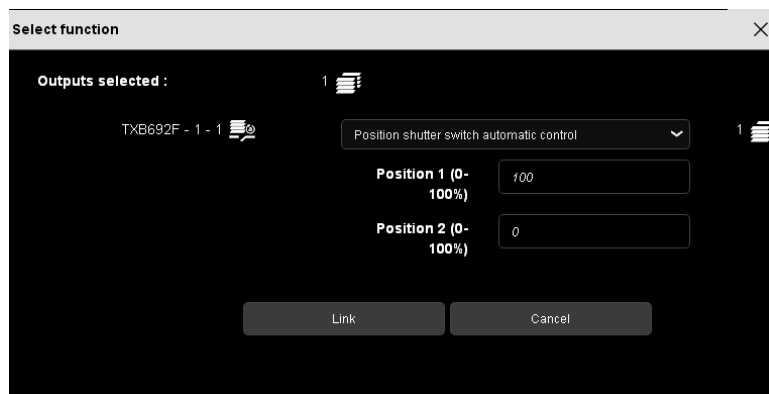

- **Automatic control inter slat angle:** allows positioning blind slats according to a value in % using a switch and automatic control.

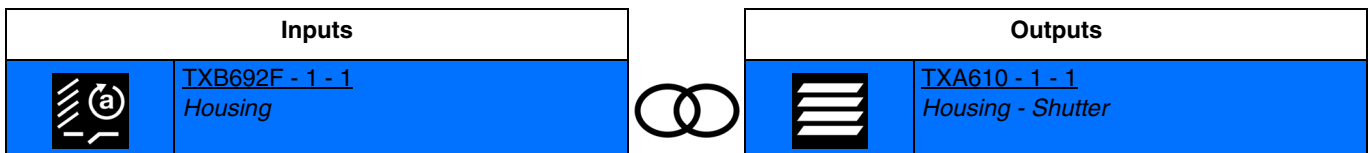

Closing input contact: delayed closing of output contacts for position 1 of the blind slats.
 Opening input contact: delayed closing of output contacts for position 2 of the blind slats.

Note: When the connection is made, values must be defined in % for blind slat positions 1 and 2 (0%: slats open, 100%: slats closed).



- **Automatic control inter shutter and slat angle:** allows positioning a rolling shutter or blind to the desired height and blind slats according to a value in % using a switch or automatic control.

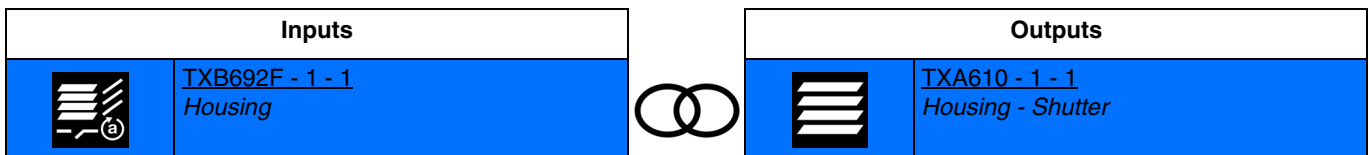

Closing input contact: delayed closing of output contacts for position 1 of the shutter or blind and for position 1 for blind slats.
 Opening input contact: delayed closing of output contacts for position 2 of the shutter or blind and for position 2 for blind slats.

Note: When the connection is made, values must be defined in % for shutter positions 1 and 2 (0%: high position, 100%: low position) and values in % for blind slats positions 1 and 2 (0%: slats open, 100%: slats closed).

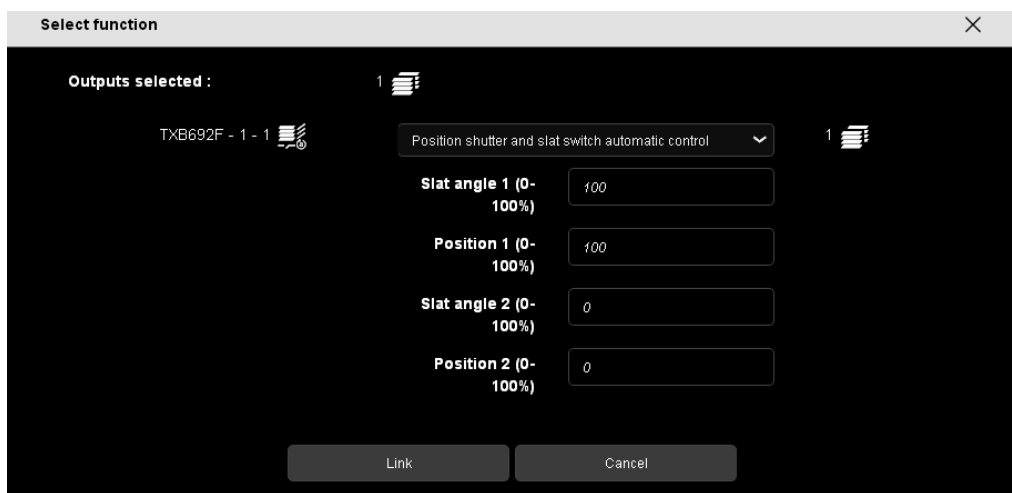

- **Automatic control deactivation:** deactivates automatic control.

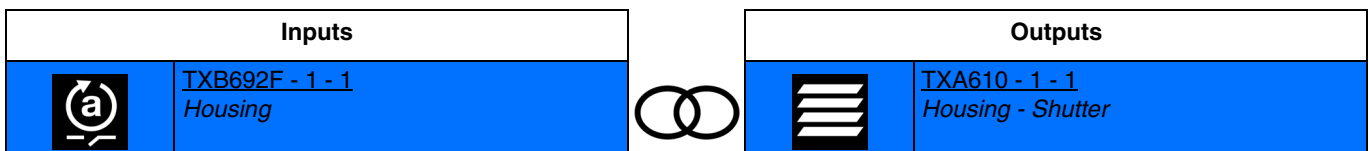

Closing input contact: deactivated automatic control.
 Opening input contact: activated automatic control.

- **Deactivation Automatic control push-button:** deactivates automatic control using a push-button.

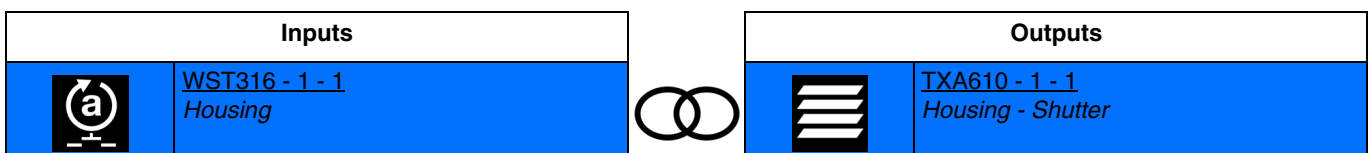

Closing input contact: deactivated automatic control.
 Opening input contact: no action.
 A second closing input contact triggers activation of the automatic control.

Note: This function is only available with push-button input products with LEDs indicating status.

4.3.2.7 Scene

The Scene function is used to switch groups of outputs into a configurable predefined state. Each output can be included in 8 different scenes.

When the scene is memorised, the position and angle of the slats are memorised.

Operating principle:

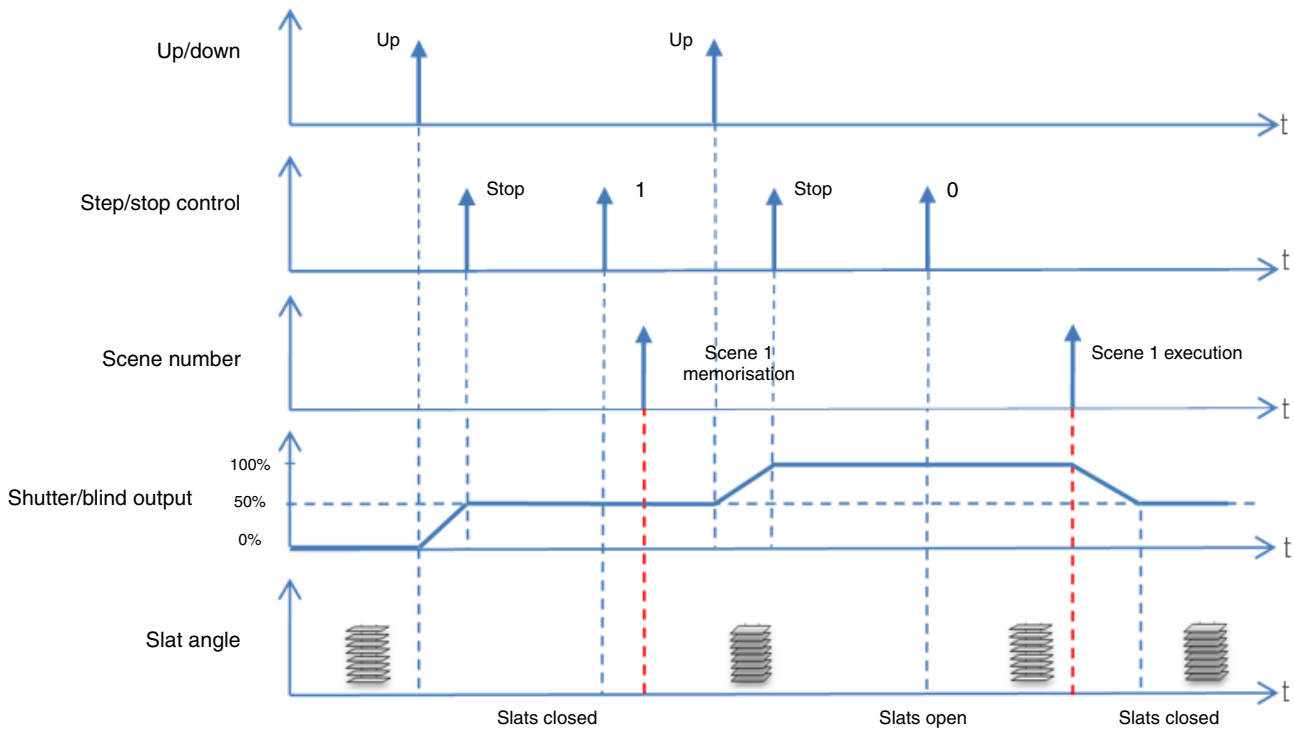

Learning and storing scenes

This process is used to change and store a scene. For example, by locally pressing the key in the room or by emission of the values from a visualization.

To access and store scenes, the following values must be sent:

Scene number	Access scene (Object value: 1 byte)	Store scene (Object value: 1 byte)
1-64	= Scene number - 1	= Scene number + 128
Examples		
1	0	128
2	1	129
3	2	130
...	...	
64	63	191

Here is the scene memorisation for local switches, for example.

- Activate scene by briefly pressing the transmitter that starts it,
- The outputs (lights, shutters, etc.) are set in the desired state using the usual local control devices (buttons, remote control, etc.),
- Memorise the status of the outputs with a press greater than 5 seconds long on the transmitter that starts the scene. The memorisation can be displayed by short-term activation of the outputs.

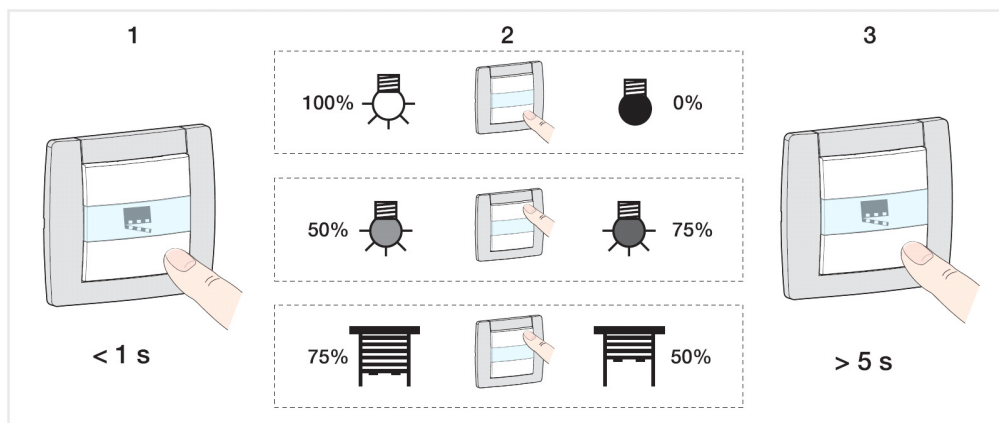

Product learning and memorisation

This procedure allows modifying a scene using a local action on the push buttons located on the front side of the product.

- Activate the scene using a short press on the ambiance push button, which triggers the scene,
- Set the product to manual mode and set the shutters or blinds to the desired status by pressing the associated push-buttons,
- Return to Auto mode,
- Save the scene using a long push for more than 5 seconds on the push-button that triggers the scene,
- Memorisation is signalled by the inversion of the concerned output status for 3 sec.

■ Links

- **Scene:** the scene is activated by pressing the push-button.

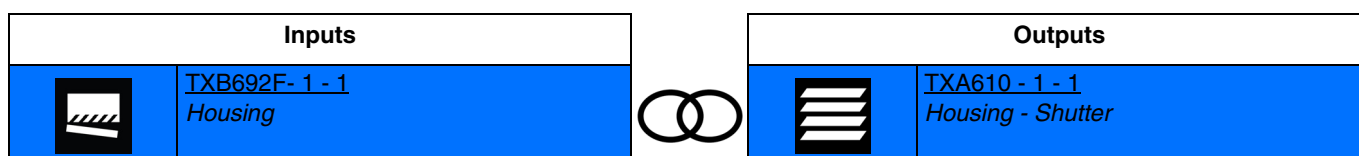

Closing input contact: scene activation.
Opening input contact: no action.

Note: At the time the connection is made, the scene number must be defined for the closing input contact.



- **Scene switch:** the scene is activated according to the closing or opening input contact.

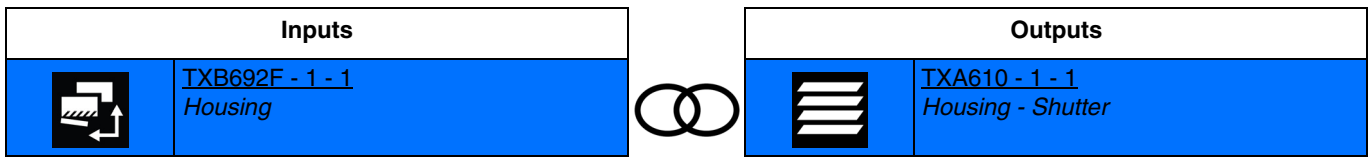

Closing input contact: scene activation 1.
 Opening input contact: scene activation 2.

Note: At the time the connection is made, the scene number must be defined for the closing and opening input contact.



5. Appendix

5.1 Specifications

TXB602F

Supply voltage KNX	21...32 V DC SELV
Breaking capacity	μ 6 A AC1 230 V \sim
Switching current at $\cos \Phi = 0.8$ max.	6 A
Minimum switching current	10 mA
Operating altitude max.	2000 m
Degree of contamination	2
Surge voltage	4 kV
Degree of protection of housing	IP20
Impact protection	IK 04
Overvoltage class	III
Operating temperature	-5 °C...+45 °C
Storage/transport temperature	-20 °C ... +70 °C
Maximum switching cycle rate at full load	
switching cycle/minute	20
Connection capacity	0,75 mm ² ...2,5 mm ²
max. tightening torque	0.5 Nm
Cross-head design	PZ1
Standards	EN 50491-3 ; EN 60669-2-1
Dimensions	44 x 43 x 22,5 mm
Own consumption on the KNX bus:	
typical	7 mA
in standby	5 mA
Incandescent lamps	500 W
HV halogen lamps	500 W
Conventional transformer	500 VA
Electronic transformer	500 W
Fluorescent lamps	
--without ballast	500 W
--with electronic ballast	6 x 48 W
Energy-saving lamps/LED lamps	5 x 13 W

TXA6xxB

Supply voltage KNX	DC 21...32 V SELV
Breaking capacity	μ 10A AC1 230V \sim
Incandescent lamps	1200 W
HV halogen lamps	1200 W
Conventional transformers	1200 W
Electronic transformers	1000 W
Fluorescent lamps:	
--without ballast	1000 W
--with electronic ballast (mono/duo)	15 x 36 W
Energy-saving lamps	12 x 23 W
Switching current at $\cos \Phi = 0.8$ max.	10 A
Minimum switching current	100 mA
Operating altitude max,	2000 m
Degree of contamination	2
Surge voltage	4 kV
Degree of protection of housing	IP 20
Degree of protection of housing under front panel	IP30
Impact protection	IK 04
Overvoltage class	III
Operating temperature	-5° ... +45°C
Storage/transport temperature	-20° ... +70°C
Maximum switching cycle rate at full load	
6 switching cycle/minute	
Connection capacity	0,75 mm ² ...2,5 mm ²
Standards	EN50491-3 ; EN60669-2-1
Variants 4/2gang	
Energy dissipation	3 W
Maximum current permitted per device max.	30 A
Own consumption on the KNX bus:	
--typical	5 mA
--in standby	3 mA
Dimension 4 TE,	4 x 17,5 mm
Variants 6/3gang	
Energy dissipation	5 W
Maximum current permitted per device max.	45 A
Own consumption on the KNX bus:	
--typical	5 mA
--in standby	3 mA
Dimension 4 TE,	4 x 17,5 mm
Variants 8/4gang	
Auxiliary voltage	230 V AC, + 10 % .. - 15 % 240 V, + 6 % .. - 6%
Maximum current permitted per device max.	60 A
Energy dissipation	6 W
Own consumption on the KNX bus:	
--typical	6 mA
--in standby	4 mA
Own consumption on the KNX bus with mains connection:	
--typical	2 mA
--in standby	2 mA
Dimension 6 TE,	6 x 17,5 mm
Variants 10/5gang	
Energy dissipation	7 W
Maximum current permitted per device max.	75 A
Own consumption on the KNX bus:	
--typical	6 mA
--in standby	4 mA
Dimension 6 TE,	6 x 17,5 mm

TXA6xxD

Supply voltage KNX	DC 21...32 V TBTS
Breaking capacity	μ16A AC1 230V~
Incandescent lamps	2300 W
HV halogen lamps	2300 W
Conventional transformers	1600 W
Electronic transformers	1200 W
Fluorescent lamps:	
--without ballast	1200 W
--with electronic ballast (mono/duo)	20 x 36 W
Energy-saving lamps	18 x 23 W
Switching current at cos Φ = 0.8 max.	16 A
Minimum switching current	100 mA
Operating altitude max,	2000 m
Degree of contamination	2
Surge voltage	4 kV
Degree of protection of housing	IP 20
Degree of protection of housing under front panel	IP30
Impact protection	IK 04
Overvoltage class	III
Operating temperature	-5° ... +45°C
Storage/transport temperature	-20° ... +70°C
Maximum switching cycle rate at full load	
switching cycle/minute	6
Connection capacity	0,75 mm ² ...2,5 mm ²
Standards	EN50491-3 ; EN60669-2-1
Only C load variants	
Fluorescent lamps with conv. ballast, parallel connection	1500 W, 200 μF
Variants 4/2gang	
Energy dissipation	8 W
Maximum current permitted per device max.	45 A
Own consumption on the KNX bus:	
--typical	5 mA
--in standby	3 mA
Dimension 4 TE,	4 x 17,5 mm
Variants 6/3gang	
Energy dissipation	12 W
Maximum current permitted per device max.	60 A
Own consumption on the KNX bus:	
--typical	5 mA
--in standby	3 mA
Dimension 4 TE,	4 x 17,5 mm
Variants 8/4gang	
Auxiliary voltage	230 V AC, + 10 % .. - 15 % 240 V, + 6 % .. - 6%
Maximum current permitted per device max.	80 A
Energy dissipation	12 W
Own consumption on the KNX bus:	
--typical	6 mA
--in standby	4 mA
Own consumption on the KNX bus with mains connection:	
--typical	2 mA
--in standby	2 mA
Dimension 6 TE,	6 x 17,5 mm
Variants 10/5gang	
Energy dissipation	15 W
Maximum current permitted per device max.	100 A
Own consumption on the KNX bus:	
--typical	6 mA
--in standby	4 mA
Dimension 6 TE,	6 x 17,5 mm

TXM6xx

Supply voltage KNX	DC 21...32 V SELV
Breaking capacity	μ 16A AC1 230V~
Incandescent lamps	2300 W
HV halogen lamps	2300 W
Conventional transformers	1500 VA
Electronic transformers	1500 W
Fluorescent lamps:	
--without ballast	1000 W
--with electronic ballast (mono/duo)	20 x 36 W
--with conv. ballast, parallel circuit	1000 W, 130 μ F
Energy-saving/LED lamps	25 x 18 W
Switching current at $\cos \Phi = 0.8$ max.	16 A
Minimum switching current 230 V AC	100 mA
Operating altitude max.	2000 m
Degree of contamination	2
Surge voltage	4 kV
Degree of protection of housing	IP20
Degree of protection of housing under front panel	IP30
Impact protection	IK 04
Overvoltage class	III
Operating temperature	-5° ... +45°C
Storage/transport temperature	-20° ... +70°C
Maximum switching cycle rate at full load:	
switching cycle/minute	6
Connection capacity screw terminals:	
rigid	0,5 mm ² ... 6 mm ²
flexible, with conductor sleeve	0,5 mm ² ... 4 mm ²
max. tightening torque	0.5 Nm
Screw print type	PZ1
Standards	EN50491-3 ; EN60669-2-1
Variants 16/8gang	
Power dissipation max.	20 W
Permissible highest current strength per device max.	176 A
Own consumption on the KNX bus:	
--typical	5 mA
--in standby	3 mA
Dimension 8 TE,	8 x 17,5 mm
Variants 20/10gang	
Power dissipation max.	25 W
Permissible highest current strength per device max.	200 A
Own consumption on the KNX bus:	
--typical	5 mA
--in standby	3 mA
Dimension 10 TE,	10 x 17,5 mm

5.2 Characteristics

Device	TXB602F	TXA604B/D	TYA606B/D	TYA608B/D	TXA610B/D	TXM616D	TXM620D
Max. number of group addresses	254	254	254	254	254	254	254
Max. number of allocations	255	255	255	255	255	255	255
Objects	20	40	60	80	100	160	200

5.3 Index of objects

5.3.1 ON/OFF

ON/OFF	38
Status indication ON/OFF	38
Timer.....	38
Priority.....	39
Status indication priority.....	39
Scene.....	40
ON/OFF automatic control	40
Automatic control deactivation	41
Automatic control deactivation status	41
Load shedding	41

5.3.2 Shutter/blind

Up/down.....	44
Step/stop (short press).....	44
Stop (Short press).....	45
Position in %	45
Slat angle in %	45
Position in % indication	46
Slat angle indication in %.....	46
Upper position reached.....	46
Lower position reached.....	47
Priority.....	47
Status indication priority.....	47
Scene.....	48
Alarm 1.....	48
Alarm 2.....	48
Alarm 3.....	49
Position in % automatic control.....	49
Slat angle in % automatic control.....	49
Automatic control deactivation	50
Automatic control deactivation status	50

