

**TYA664BN**  
4 channel dimmer with output combination 600W



**Design and layout of the device**

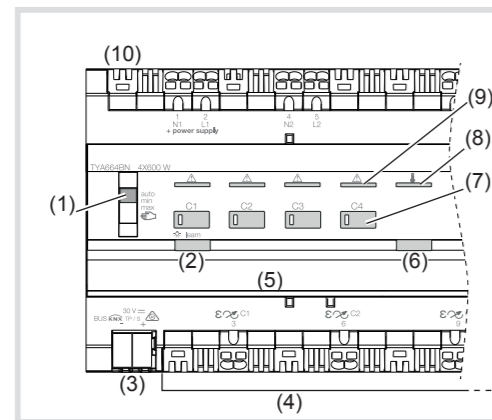

Figure 1 : Device overview

- (1) Slide switch **auto/min/max/** (min/max slide switch settings are unavailable by default on TYA664BN, it must be activated in ETS)
- (2) Illuminated button for dimming mode
- (3) KNX bus connection terminal
- (4) Connection of load
- (5) Labelling field with cover
- (6) Illuminated programming button
- (7) Operation button for manual operation with status LED
- (8) Control LED overheating protection
- (9) Control LED short-circuit and overload protection per output
- (10) Mains connection

**Function**

**System information**

This device is a product of the KNX system and corresponds to the KNX guidelines. Detailed specialised knowledge obtained from KNX training courses is required for understanding. The planning, installation and commissioning of the device is carried out with the help of KNX-certified software.

**system link commissioning:**

The function of the device is software-dependent. The software is to be taken from the product database. You can find the latest version of the product database, technical descriptions as well as conversion and additional support programmes on our website.

**Functional description**

The device has four load outputs that can be connected to different phases. It works with automatic load detection depending on the connected load in the phase cut-on or phase cut-off and enables switching and dimming via the KNX bus of:

- Incandescent lamps and halogen lamps
- Low-voltage halogen lamps with conventional or electronic transformer
- dimmable LED and energy-saving lamps

Additionally, the device has a learn function for more efficient control of energy-saving lamps and 230 V LED lamps.

**Output combination**

The 4 channels can be combined together with different allowed combinations in order to dim more powerful loads.

Before an ETS download the device will automatically run a test to recognize if the cabling made matches with one of the authorized combinations, after an ETS download the device will automatically run a test to recognize if the cabling made

matches with the "output combination" parameter filled in ETS.

Authorized combinations:

- (1)-(2)-(3)-(4)
- (1+2)-(3)-(4)
- (1+2+3)-(4)
- (1+2+3+4)
- (1)-(2)-(3+4)
- (1+2)-(3+4)

If another not-allowed output combination is detected the product will indicate with the red LEDs on the buttons which output group is not allowed/ in default.

**Correct use**

- Dimming of electric loads ~ 230 V
- Installation on DIN rail according to DIN EN 60715 in distribution box

**Product characteristics**

- Status display of the output on the device
- Manual activation of the output on the device possible, building site operation
- Automatic load detection
- Setting the minimum and maximum dimming value
- Timer functions
- Scene function
- Forced position by higher-level controller
- Combination of the outputs to dim more power

**Short-circuit and overload protection**

Short-circuit and overload are signalled via the control LED (9). The load is throttled (see Troubleshooting).

**Overheating protection**

Overheating of the device is signalled by a permanent light of the control LED (8). The connected load is throttled (see Troubleshooting).

**Operation**

**Manual operation**

Bus and mains power supply are present.

- Push switch (1) to position
- Manual operation is switched on, the output can be controlled using the operation button (7).

During manual operation, the controller is deactivated via the KNX bus.

system link commissioning: Depending on the programming, the manual operation is activated permanently or for a time period configured via the application software. If the manual operation is disabled via the application software, no activation takes place.

Or:

- Move switch (1) to position auto.

The manual operation is switched off. Operation takes place solely via the KNX bus. The output adopts the brightness predefined by the bus controller.

**Operating output in manual operation**

Operation takes place by a short or long press on the operation button (7) (table 1).

If the integrated LED flashes when pressing the operation button, no load is connected.

Status	Performance when pressing the button
Load is switched off. Status LED of the button (7) is off.	Short press on button: Switch ON the connected load. LED lights up.  Long press on button: Dim up to maximum brightness. Status LED of button (7) lights up.
Load is switched on. Status LED of the button (7) lights up.	Short press on button: Switch OFF the connected load. Status LED of button (7) goes out.  Long press on button: Changes the current brightness. Dimming takes place in the opposite direction of the last dimming operation until maximum or minimum brightness.

Table 1 : Manual operation

**Information for electricians**

**Installation and electrical connection**

**DANGER!**  
Touching live parts can result in an electric shock!  
An electric shock can be lethal!  
Disconnect the connecting cables before working on the device and cover all live parts in the area!

**CAUTION!**  
Impermissible heating if the load of the device is too high!  
The device and the connected cables may get damaged in the connection area!  
Do not exceed the maximum current carrying capacity!

- Observe temperature range. Provide sufficient cooling.
- Mount device onto DIN rail in accordance with DIN EN 60715.

**Connect device**

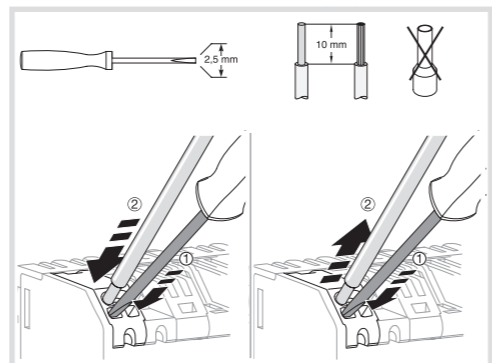

Fig 2 : Installation/removal with plug-in terminals

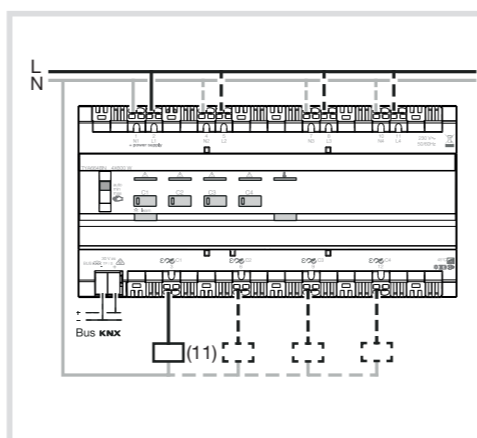
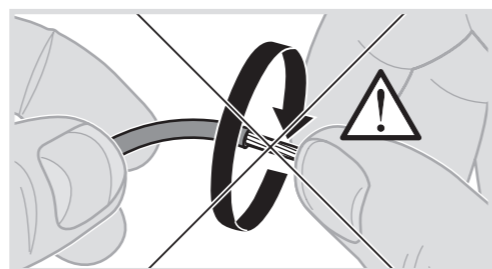

Figure 3 : Device connection 1-phase

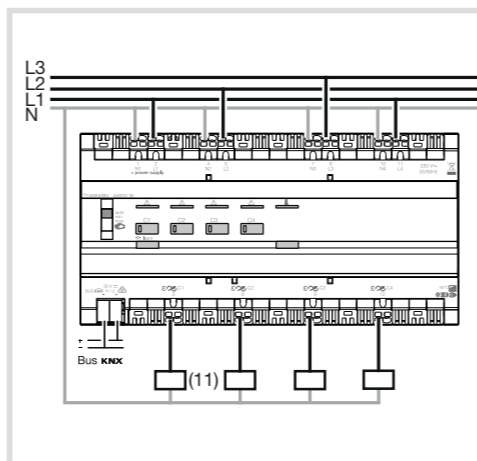

Figure 4 : Device connection multi-phase

**(11) Load**

- Connect bus cable via connecting terminal (3).
- Connect load (11) on the lower terminal strip (4) of the device.

To ensure proper functioning of the device the terminal blocks N1 and L1 have to be wired with mains power. If mains is missing on L1 the product will be totally blocked.

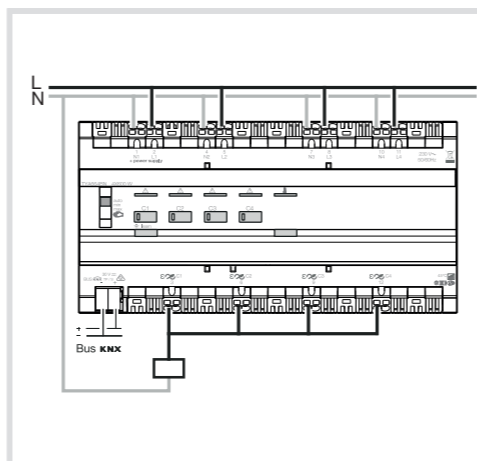

Figure 5 : Output combination (1+2+3+4)

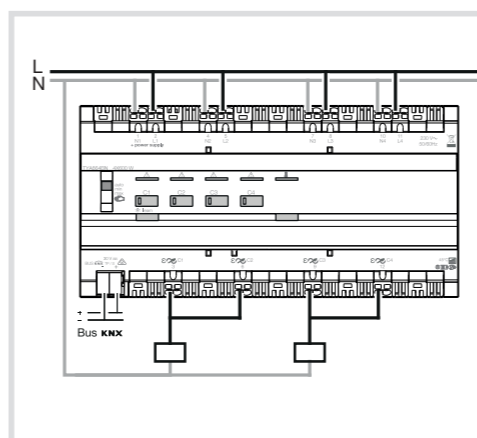

Figure 6 : Output combination (1+2)-(3+4)

**Start-up**

**system link: Loading physical address and application software**

The switch for manual operation (1) is in position auto.

- Switch on mains voltage.
- Switch on bus voltage
- Press programming button (5).

The button lights up.

If the button does not light up, no bus voltage is present.

- Load the physical address into the device. Status LED of the button goes out.
- Load application software.
- Note down the physical address on the labelling field (5).

**Start up the device.**

- Switch on mains supply.

**Functional test**

The functionality of the outputs is displayed via the status LED of the operation button (7).

LED status	Meaning of the signal
LED lights up permanently	Load is activated
LED flashes	No load connected

**Setting minimum and maximum dimming value on the device**

The device is ready for operation.

- Setting brightness value

The brightness value can be set by manual operation on the device or by the programmed dimming button of an operating unit.

- Set switch (1) to max. in order to apply the set brightness as maximum dimming value.

Or:

- Set switch (1) to min. in order to apply the set brightness as minimum dimming value.
- Keep the operation button (7) pressed for more than 3 s.

The status LED flashes twice. The set brightness value is saved.

If the minimum or maximum dimming value are outside the setting range, the status LED (7) flashes permanently after the save operation.

**Setting dimming mode on the device**

In the factory setting, the device performs an automatic load detection for ohmic, inductive and capacitive loads and selects the suitable dimming performance. If the load type is known, this can

be specified on the device without performing an automatic load detection.

The device is ready for operation.

- Keep the dimming mode button (2) pressed until the status LED of the operation button (7) flashes.
- Select the channel for which you wish to change the dimmer mode by pressing on button (7).
- Briefly press the dimming mode button (2) repeatedly until the coloured lighting of the button (2) displays the desired operating mode (Table 2).
- Keep the dimming mode button (2) pressed until the lighting of the button (2) flashes quickly.

While the button is flashing quickly, the selected operating mode is set. After that, the operating mode is displayed for approx. 3 s before the button goes out.

If the setting is not confirmed by holding down the button, the device will revert to its previous dimming mode after 2 minutes.

If the operating mode selected is not suitable for the connected load, the dimming channel will reset to "factory setting" automatically.

Lighting button (2)	Dimming mode
yellow	Energy-saving lamps <sup>1)</sup>
purple	Capacitive load
blue	Inductive load
red	LED load
green	taught-in load <sup>1)</sup>
white	automatic load setting (factory setting)

1) The load for the selected dimming mode is only taught in for approx. 30 s. This can lead to temporary impairment of the lighting.

Table 2

**Displaying dimming mode**

- Briefly press the dimming mode button (2). The coloured lighting of the button will display the current operating mode for approx. 3 s (Table 2).

**Teach in the load of an operating unit via the button**

When teaching in the connected load, the dimming performance for compact fluorescent lamps and LED lamps is optimised.

The device is ready for operation. The dimming button of an operating unit has been programmed with the taught-in output.

- Press the dimming button 5 times briefly, then keep the button pressed until the load switches off.

The short press is independent of the configured operating performance on the operating unit ( 5 x On, 5 x Off or 5 x On/Off)

- Press button once briefly.

The teach-in procedure lasts approx. 30 s. To optimise the dimming performance, a dimming operation is performed. After teaching in, the connected load lights up at maximum brightness and flashes once. The teach-in process is complete.

Depending on the connected load, the minimum brightness may change due to the teach-in process.

**Resetting taught-in loads in the device**

The device can be reset to automatic load detection, e.g. after replacing luminaires.

Automatic load detection is particularly suitable for loads that can be dimmed clearly in the phase cut-on or phase cut-off ("conventional loads").

The device is ready for operation. The dimming button of an operating unit has been programmed with the taught-in output.

- Press the dimming button 5 times briefly, then keep the button pressed until the load switches off.

The short press is independent of the configured operating performance on the operating unit ( 5 x On, 5 x Off or 5 x On/Off).

If the dimming button is no longer pressed within the next 10 seconds, the learned dimming principle is retained.

- Press button 2 times briefly.

The load flashes twice. The automatic load detection is enabled again.

**Appendix**

**Technical data**

supply voltage via mains	230 V ~, + 10%/-15 %	240 V ~, +/-6%
Supply voltage KNX/EIB	≐ 21 ... 32 V SELV	
Current consumption KNX/EIB	2.4 mA	
Consumption without load	780 mW	
Fan-in	1 m	
Product consumption	1W max	
Product power dissipation	2,4W max	
Operating altitude	2000 m. max	
Pollution degree	2	
Surge voltage	4 kV	
Degree of protection of housing	IP 20	
Degree of protection of housing under front panel	IP30	
IK (impact protection)	04	
Overvoltage class	III	
Dimension	10 modules, 10 x 17.5 mm	
Connection capacity	0.75 mm <sup>2</sup> ...2.5 mm <sup>2</sup>	
Operating temperature	-5 ...+ 45°C	
Storage temperature	- 20 ...+ 70°C	
Upstream circuit breaker	10 A up to 2300V	
	16 A between 2300V and 2400V	

**Load that can be connected per output**

Output Combination	- 230 V- incandescent lamps, halogen lamps - 12 V- / 24 V- halogen lamps with conventional transformer - 12 V- / 24 V- halogen lamps with electronic transformer - 12 V- / 24 V- energy-saving lamps (CFL)/LED lamps with dimmable driver	
	Min	Max
1 output independent channel	5W (1 driver)	600W (10 drivers)
2 outputs combined in 1 channel	300W (5 drivers)	1200W (16 drivers)
3 outputs combined in 1 channel	600W (8 drivers)	1800W (22 drivers)
4 outputs combined in 1 channel	900W (11 drivers)	2400W (28 drivers)
Output Combination	- Dimmable 230V- energy-saving lamps (CFL)/ LED lamps	
	Min	Max
1 output independent channel	5W (1 lamp)	120W (10 lamps)
2 outputs combined in 1 channel	40W (5 lamps)	240W (16 lamps)
3 outputs combined in 1 channel	80W (8 lamps)	360W (22 lamps)
4 outputs combined in 1 channel	120W (11 lamps)	480W (28 lamps)

\*Driver limitations need to be respected only for energy saving lamps used with drivers.

Conventional or electronic transformers should not be operated with less than 75% of their nominal load.

**Troubleshooting**

**Manual operation not possible**

Cause 1 : Switch (1) not moved to

Move switch to

Cause 2 : Manual operation has not been enabled (system link)

Enable manual operation via application software.

**Connected loads do not light up**

Cause 1 : Electronic short-circuit and overload protection has triggered, control LED (9) lights up/ flashes.

Reduce connected load, check wiring and repair if necessary.

Cause 2 : Overheating protection has triggered, control LED (8) lights up.

Reduce connected load, provide sufficient cooling, increase distance to adjacent devices.

Cause 3 : Phase L1 is missing, phase L1 presence is necessary for any output to work

Cause 4 : The phase (L1, L2, L3, L4) of the respective output (Output 1, 2, 3 or 4) is missing

Cause 5 : Before an ETS download, the cabled output combination doesn't correspond to an authorized output combination

Cause 6 : After an ETS download, the output combination doesn't correspond to the output combination parameter set in ETS

**Bus operation is not possible**

Cause 1 : Bus voltage is not present.

Check bus connection terminals for correct polarity.

Check bus voltage by briefly pressing the programming button (6), red LED lights up if bus voltage is present. If mains voltage is present without bus voltage, the red LED is lit up permanently.

Cause 2 : Manual operation is active. Switch (1) is in position

Move switch (1) to position auto.

**Correct Disposal of This product**  
(Waste Electrical & Electronic Equipment).  
 (Applicable in the European Union and other European countries with separate collection systems).

This marking shown on the product or its literature indicates that it should not be disposed with other household waste at the end of its working life. To prevent possible harm to the environment or human health from uncontrolled waste disposal, please separate this from other types of waste and recycle it responsibly to promote the sustainable reuse of material resources. Household users should contact either the retailer where they purchased this product, or their local government office, for details of where and how they can take this item for environmentally safe recycling. Business users should contact their supplier and check the terms and conditions of the purchase contract. This product should not be mixed with other commercial waste for disposal.

Usable in all Europe C € and in Switzerland