

	application software	
<ul style="list-style-type: none"> ▲ Manufacturers ▲ Hager Electro ▲ Outputs <ul style="list-style-type: none"> 8-outputs modules 16-outputs modules 20-outputs modules 	<p>Switching actuator/blind actuator x-gang KNX Secure, 16 A, C load</p> <p><i>Electrical/Mechanical characteristics: see product user manual</i></p>	

	Product reference	Product designation	Application software ref	TP device Radio device
	TYAS608D	Switching actuator/blind actuator 8-gang KNX Secure, 16 A, C load	STYAS608D 1.x Version	
	TYMS616D	Switching actuator/blind actuator 16-gang KNX Secure, 16 A, C load	STYMS616D 1.x Version	
	TYMS620D	Switching actuator/blind actuator 20-gang KNX Secure, 16 A, C load	STYMS620D 1.x Version	

Content

1. General	4
1.1 General information about this application description.....	4
1.2 ETS Programming software	4
1.3 Connexion KNX secure	4
2. General Description	7
2.1 Installation of the device	7
2.1.2 Description of the device.....	8
2.1.3 Physical addressing	9
2.2 Function modules of the application	10
2.2.1 ON/OFF.....	10
2.2.2 Shutter/blind	14
3. Parameters	18
3.1 Closing type for the outputs.....	18
3.2 Definition of the general parameters	20
3.2.1 Activation of manual mode: ON/OFF	21
3.2.2 Activation of the Status indication: ON/OFF.....	21
3.2.3 Activation of the logic blocks: ON/OFF	21
3.2.4 Status during bus power cut or download: ON/OFF	22
3.2.5 Super alarm: Shutter	22
3.2.6 Activation of manual mode: Shutter	23
3.2.7 Activation of the Status indication: Shutter.....	23
3.2.8 Activation of the logic blocks: Shutter	23
3.2.9 Status during bus power cut or download: Shutter	24
3.2.10 Restore ETS-Parameters.....	25
3.2.11 Activation of the Device diagnosis object.....	26
3.2.12 Parameters overwrite at next download	26
3.2.13 LED display	26
3.3 Super alarm	27
3.3.1 Duration activation and position	27
3.3.2 Super alarm status indication.....	29
3.4.2.3 Status indication manual mode	35
3.3.4 Position after super alarm	30
3.4 Manual mode.....	32
3.4.1 Manual mode: ON/OFF.....	32
3.4.2 Manual mode: Shutter.....	34
3.5 Status indication	37
3.5.1 Status indication ON/OFF	37
3.5.2 Status indication Shutter	39
3.6 Logic block.....	44
3.6.1 Logic block : ON/OFF.....	45
3.6.2 Logic block : Shutter.....	51
3.7 Diagnosis.....	58
3.8 Functions of each switch actuator	60
3.8.1 Function selection	60
3.8.2 ON/OFF timings function.....	66
3.8.3 Timer	70
3.8.4 Scene	74
3.8.5 Preset.....	77
3.8.6 Lock-up	82
3.8.7 Priority.....	87
3.8.8 Hours counter.....	89
3.9 Functions for each shutter/blind output	92
3.9.1 Function selection	94
3.9.2 Scene	101
3.9.3 Lock-up	104
3.9.4 Preset.....	109
3.9.5 Priority	114
3.9.6 Alarm.....	116
3.9.7 Sun protection.....	121
4. Communication objects.....	127
4.1 Communication objects General	127
4.1.1 Manual mode	128
4.1.2 Logic block	129
4.1.3 Super alarm.....	131
4.1.4 Behaviour of the device.....	131
4.1.5 Diagnosis	132

4.2 Output communication objects	133
4.2.1 ON/OFF	133
4.2.2 ON/OFF timings function	133
4.2.3 Status indication	135
4.2.4 Timer	135
4.2.5 Scene	136
4.2.6 Preset	137
4.2.7 Lock-up	138
4.2.8 Priority	139
4.2.9 Hours counter	140
4.3 Communication objects for each shutter/blind output	141
4.3.1 Control	141
4.3.2 Status indication	143
4.3.3 Scene	145
4.3.4 Preset	145
4.3.5 Lock-up	146
4.3.6 Priority	147
4.3.7 Alarm	148
4.3.8 Sun protection	149
5. Appendix	151
5.1 Technical data	151
5.2 Table of logical operations	152
5.3 Characteristics	152

1. General

1.1 General information about this application description

This document describes the operation and parameterisation of KNX devices with the aid of the Engineering Tool Software ETS. The devices are parameterised by the ETS and the required settings for operation are made during the first installation.

1.2 ETS Programming software

The application programmes are compatible with ETS5 or ETS6 and are always available in their latest version on our Internet website.

ETS version	File extension of compatible products	File extension of compatible projects
ETS 5 (v 5.0.6 ou plus)	*.knxprod	*.knxproj
ETS 6 (v 6.0.0 ou plus)	*.knxprod	*.knxproj

- ETS Application designation

Application	Product designation	Application designation
STYAS608D v1.0	TYAS608D	Switching actuator/blind actuator 8-gang KNX Secure, 16 A, C load
STYMS616D v1.0	TYMS616D	Switching actuator/blind actuator 16-gang KNX Secure, 16 A, C load
STYMS620D v1.0	TYMS620D	Switching actuator/blind actuator 20-gang KNX Secure, 16 A, C load

1.3 Connexion KNX secure

KNX Secure devices are able to encrypt and decrypt telegrams, thus adding an extra level of security to a KNX installation. This level of security can be used both during the commissioning of KNX installations as for KNX installations at runtime.

There are two types of encryption:

- KNX IP Secure : Telegrams are entirely encrypted and applied only to the KNX IP medium. This encryption must be used for KNX installations using an external IP network such as the Internet.
- KNX Data Secure : Telegrams are partly encrypted and applied to any KNX communication medium. This encryption can be used for the KNX IP medium, but only for the part of the KNX installation that is not exposed to an external IP network.

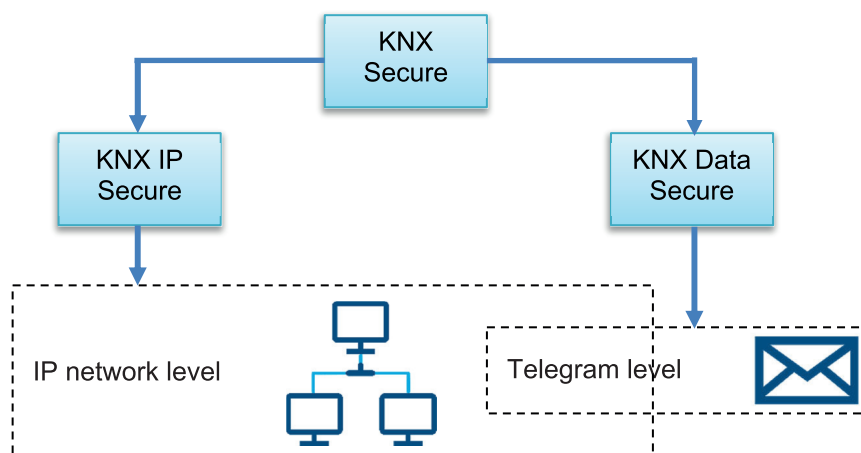

The device is KNX Data Secure capable and can be configured in the ETS project. A device certificate, which is attached to the front to the device, is required for safe commissioning. During mounting, it is recommended to remove the certificate from the device and to store it securely.

Note: It is also possible to commission the device without KNX Data-Secure. In this case, the device is not secured and behaves like other KNX devices.

Note: During the configuration of products in Secure mode, if one of the products mentioned below is installed, it is recommended to replace it by its Secure version:

- Replace the reference TYF120 (KNX/IP Interface) with the reference TYFS120
- Replace the reference TH101 (USB modular data interface) with the reference TYFS122

Commissioning of the KNX Secure mode

The device is mounted and connected ready for use.

1. Activate the secure commissioning mode in ETS.
2. Enter or scan the device certificate to add it to the project in ETS.

Note: To scan the QR code, a high-resolution camera must be used.

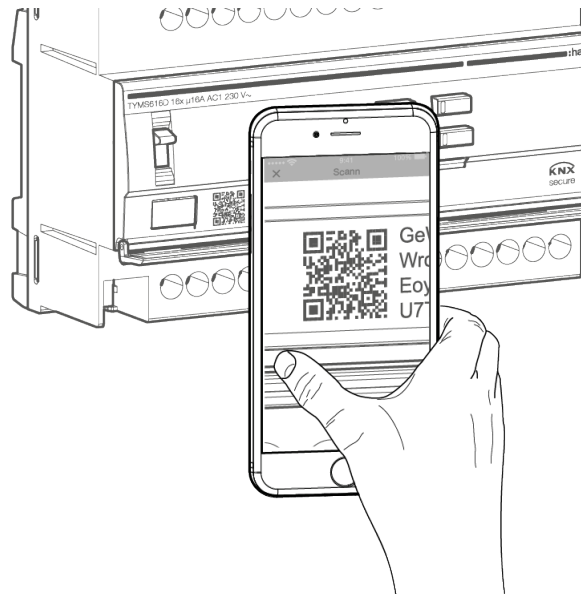

3. Record all passwords and keep them in a safe place.
4. Remove the certificate from the device (QR code) and keep it in a safe place with the passwords.

Master-Reset

The master reset restores the basic device setting.

The reset allows :

- deleting the encryption key
- deleting of the BCU password
- application of the default settings
- the application of a default individual address (15.15.255).

The device must then be recommissioned with the ETS. The manual mode is possible.

In case of Secure mode, a reinitialization deactivates the security of the device. It can then be used again with the device certificate.

How do I perform a Master Reset?

1. Switch off the device by removing the bus connection or disconnecting the power supply to the system
2. Press and hold the lighted push button
3. Switch on the device again by connecting the bus connection or by switching on the power supply to the system. The address LED lights up. After 5 seconds the LED flashes.
4. Release the address button.

The address LED lights up permanently while the master reset is in progress.

After several seconds, the LED lights off, indicating that the reset is complete. The device restarts.

Updating the firmware

The device can be updated. Firmware updates can be easily performed with the Hager ETS App. This application is free of charge and can be used on site or remotely.

How to update?

1. Login to **my.knx.org**
2. Create a new account or login with your existing account
3. Search for the **Hager Service** application
4. Add to basket
5. Go to the basket and click on Order
6. Select billing and shipping addresses
7. Click on Go to Payment
8. Confirm payment (free)Se connecter à **my.knx.org**
The application is now available in your account.
9. Download the application and the licence to update.

In the ETS project:

10. Start the application from the **Apps** tab
11. Select the device to be updated
12. Select the latest available firmware version
13. Load the device with the firmware
14. After loading is complete, activate the proprietary firmware
The device will update and restart.

2. General Description

2.1 Installation of the device

2.1.1 Overview presentation

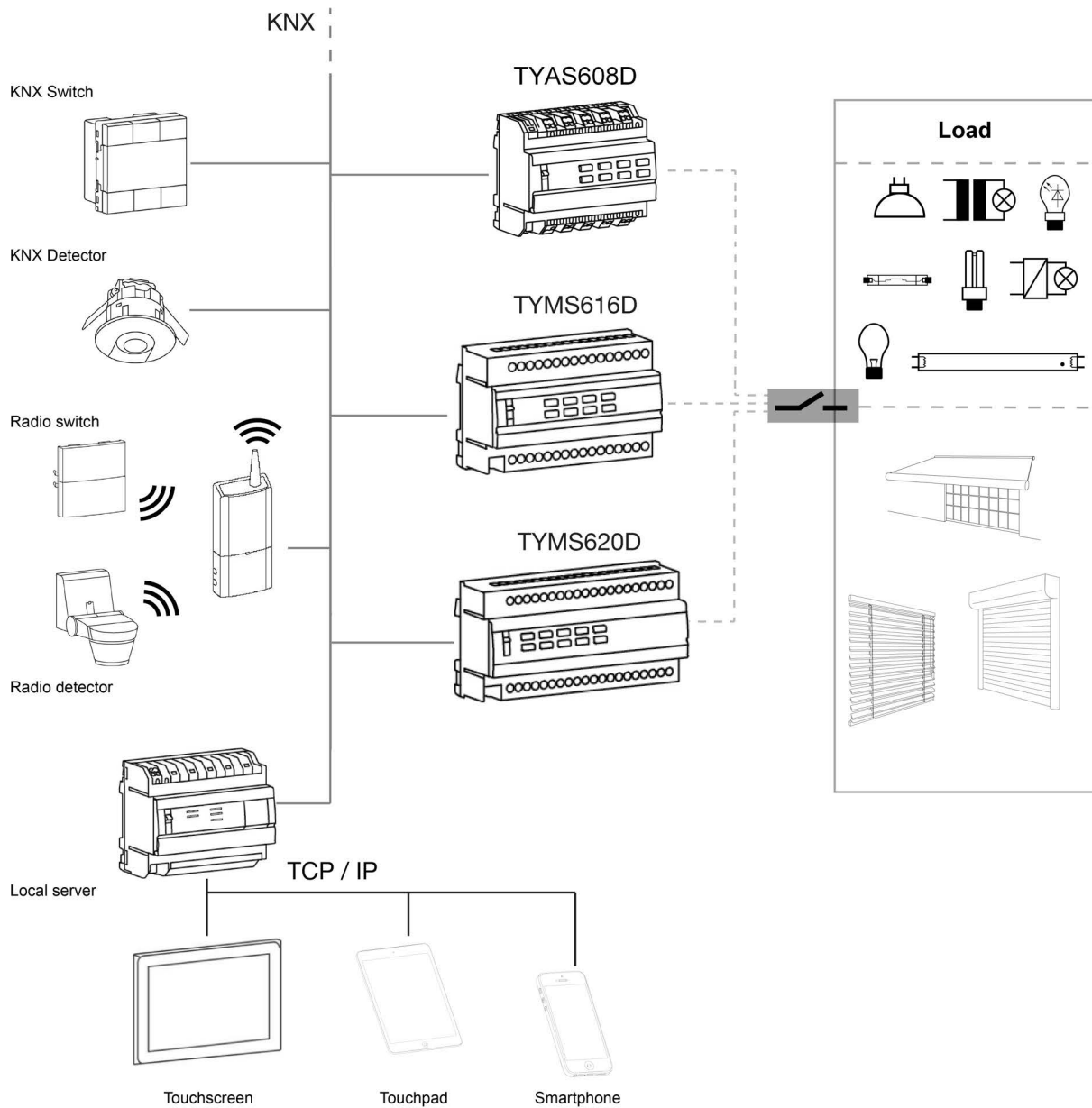

2.1.2 Description of the device

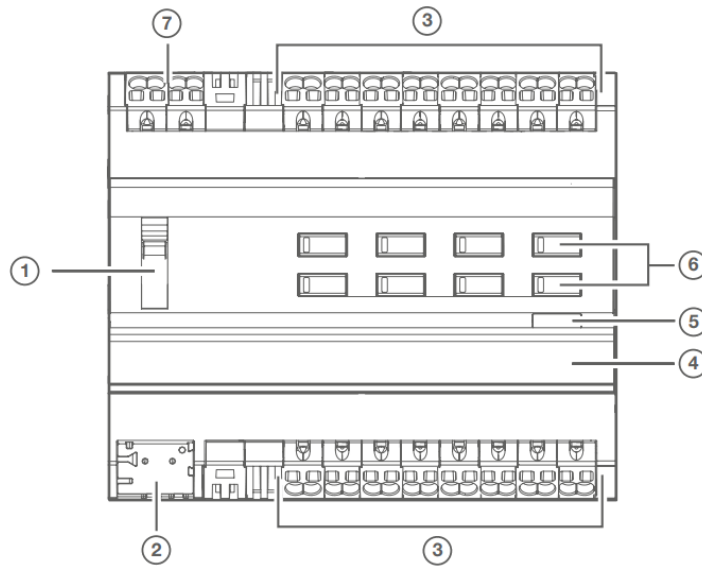

- TYAS608D

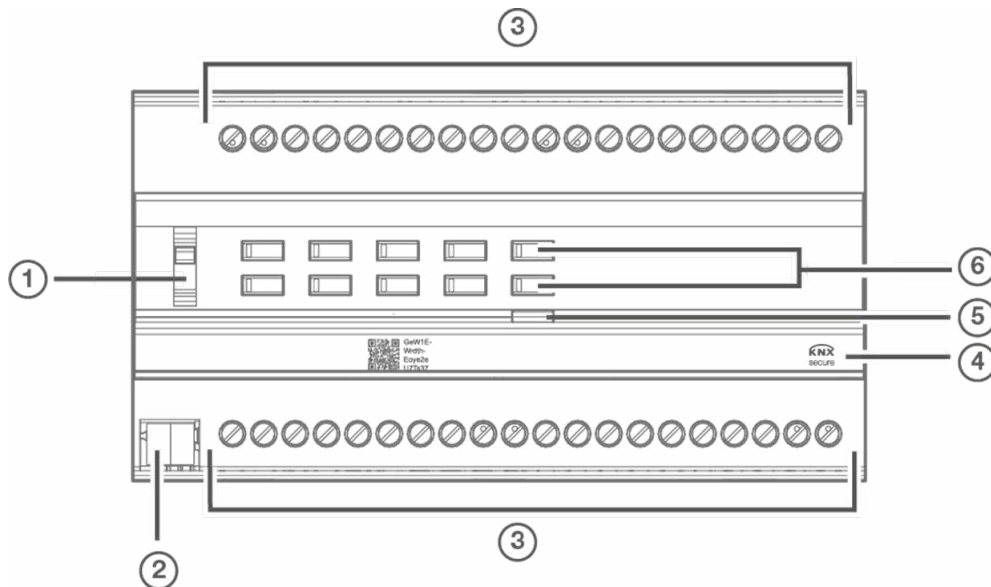

- (1) Slide switch **auto** / 
- (2) KNX bus connection terminal
- (3) Connections of loads
- (4) Labelling field
- (5) Illuminated programming button
- (6) Operation button for manual mode for each output with status LED
- (7) Connection, 230 V ~ power supply

- TYMS616D / TYMS620D



- (1) Slide switch **auto1 / auto 2** /  1 /  2
- (2) KNX bus connection terminal
- (3) Connections of loads
- (4) Labelling field
- (5) Illuminated programming button
- (6) Operation button for manual mode for each pair of outputs with status LED

2.1.3 Physical addressing

In order to perform the physical addressing or to check whether or not the bus is connected, press the lighted push button (5) on the right-hand side above the identification plates on the front of the device.

Light on = bus connected and ready for physical addressing.

Programming mode is activated, until the physical address is transferred from ETS. Pressing the button again, exits programming mode. Physical addressing can be carried out in automatic or manual mode.

2.1.4 Connection

- TYAS608D

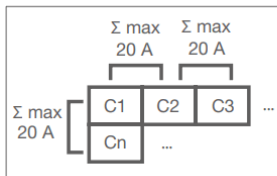
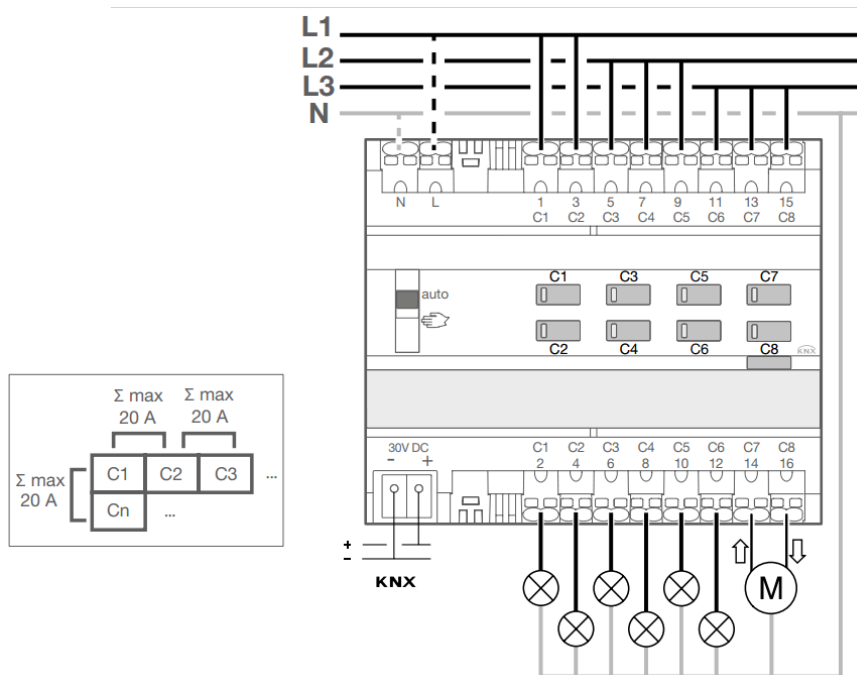

- TYMS616D / TYMS620D

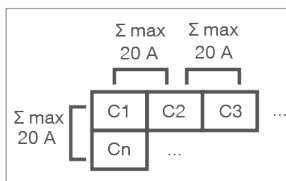
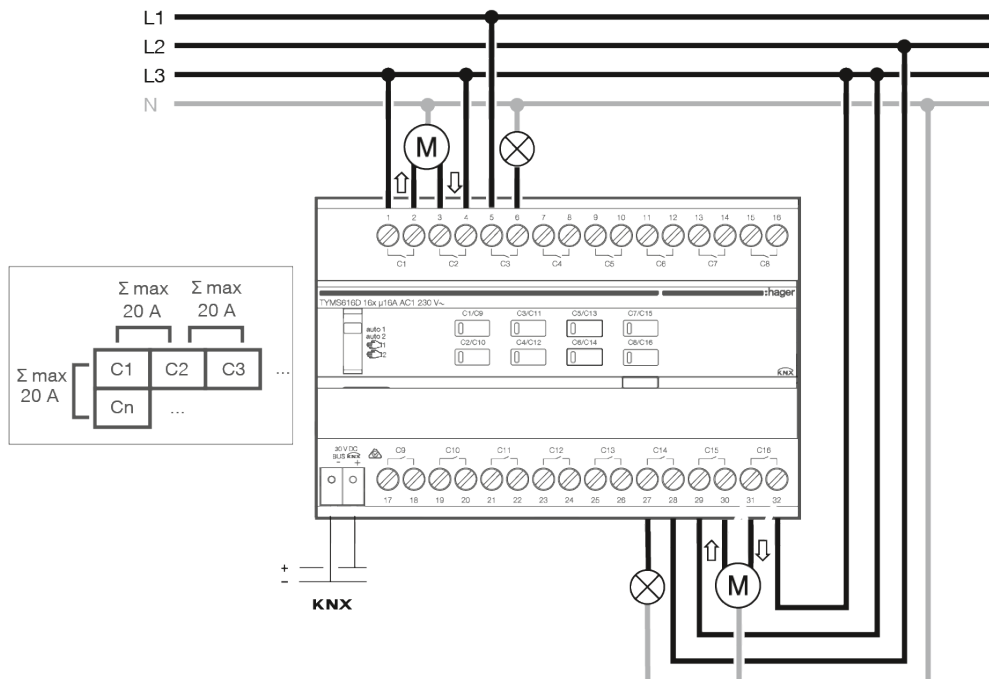

2.2 Function modules of the application

The switch actuators of the devices can be used in 2 different modes.

ON/OFF

- Each switching contact is used separately to switch a load.

Shutter/blind

- Each pair of outputs constitutes a shutter and blind channel.

A mix of the two operating modes is possible.

	Warning: The devices are delivered in ON/OFF operating mode. When connecting shutters or blinds, ensure that both contacts are not turned on at the same time!
---	---

2.2.1 ON/OFF

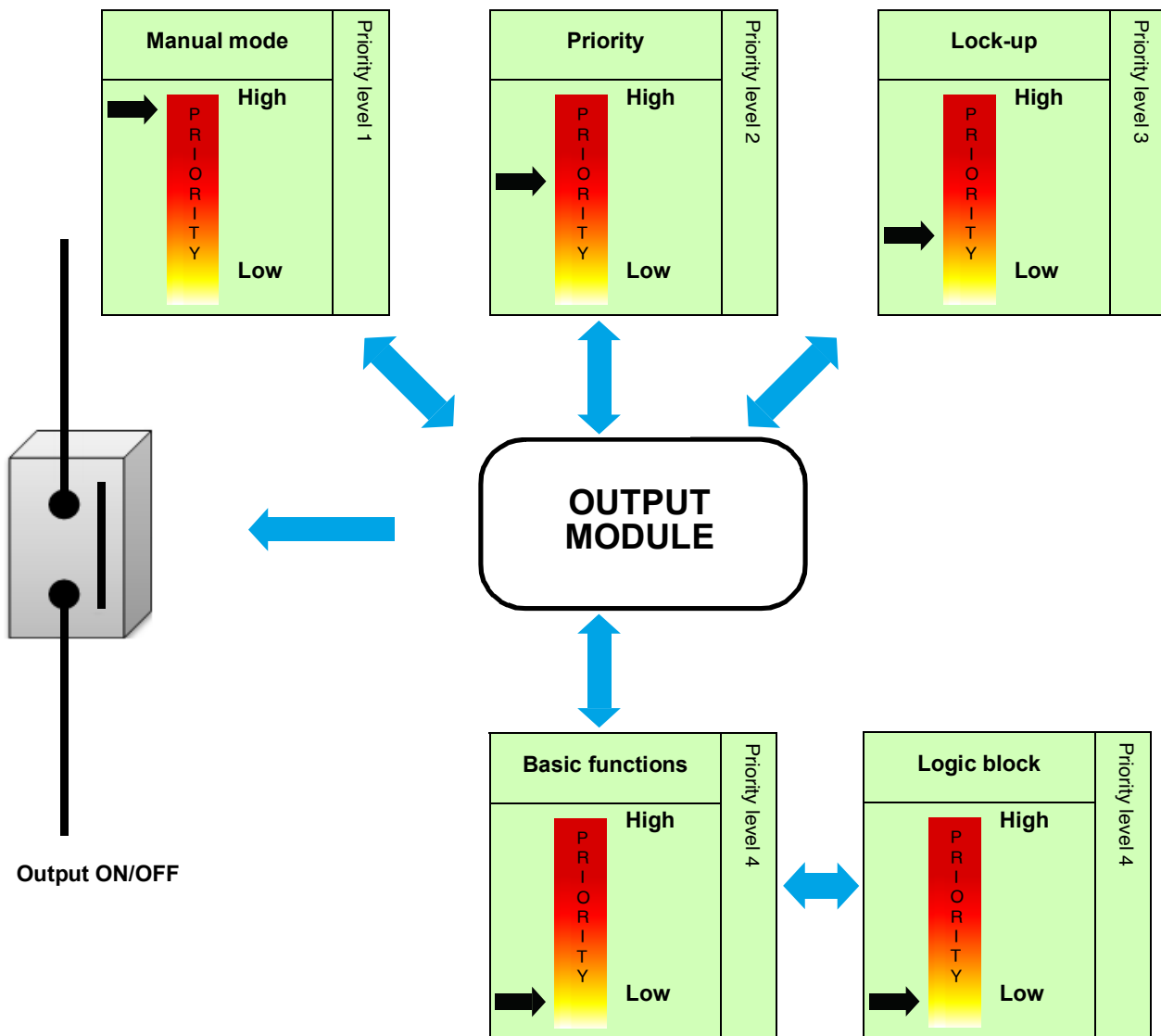

2.2.1.1 Functions for each switching channel

The applications allow individual configuration of the device outputs. The most important functions are:

■ ON/OFF

An output can be switched on or off using the ON/OFF function. The command can come from switches, buttons or other control inputs.

■ Timer

The Timer function is used to switch an output on or off for a programmable period. According to the selected operating mode of the timer, the output can be turned ON or OFF for a determined period of time. The timer may be interrupted before expiry of the delay time. A programmable Cut-OFF pre-warning announces the end of the delay time by a 1-second inversion of the output status. The timer duration can be modified via the bus KNX.

■ Time limited toggle switch

The Time-limited OFF function is a switching function that automatically switches off after a configurable delay time.

Application: Lighting of store rooms, cellars, sheds etc.

■ Priority

The Priority function is used to force the output into a defined state. The Priority function is controlled with a 2-bit command.

Priority: Manual mode > **Priority** > Lock-up > Basic function.

Only a Priority OFF command authorizes the output for control.

Application: Keeping lighting on for security reasons.

■ Lock-up

The Lock-up function is used to lock the output in a predefined state.

Priority: Manual mode > Priority > **Lock-up** > Basic function.

The Lock-up prevents actuation until an unlock command has been received. The Lock-up duration can be set.

■ Scene

The Scene function is used to switch groups of outputs into a configurable predefined state. A scene is activated by receipt of a 1-byte command. Each output can be included in 64 different scenes.

■ Preset

The Preset function is used to switch an output into various predefined states. The Preset function is activated via an object in 1-bit format. Each output can be controlled via 2 Preset objects.

■ Delay

The Delay functions are used to activate the outputs with a switching or tripping delay or with a switching and tripping delay.

■ Timer/toggle switch changeover

The Timer/toggle switch changeover function is used to switch between a Timer and a Toggle switch function applied to the communication object ON/OFF.

■ Hours counter

The Hours Counter function is used to count the overall operating time of an output in the ON or OFF state. The counter setpoint can be programmed and altered via an object.

■ Communication objects

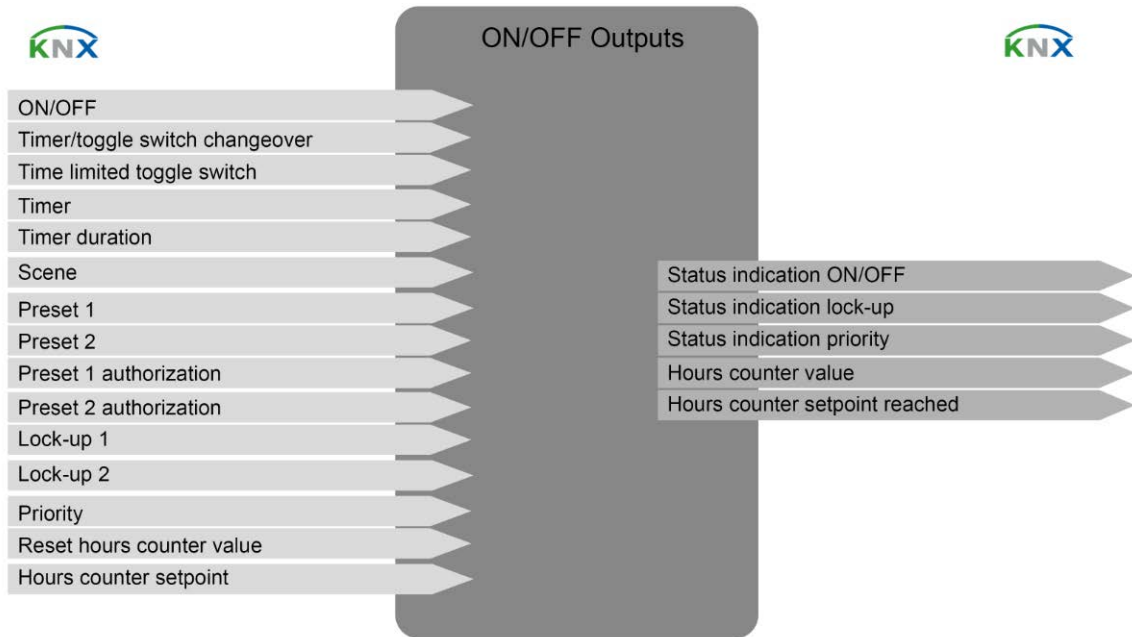

2.2.1.2 Additional functions

The applications configure the general functions of the devices. The following functions apply to the entire device:

■ **Manual mode**

Manual mode allows the device to be disconnected from the bus. In this mode, each output can be priority controlled locally. This command has the highest priority. No other command is considered when manual mode is active. Only after ending manual mode are other types of control again permitted. The duration of the manual control can be configured. Manual mode can be locked-up via the KNX bus.

■ **Status indication**

The behaviour of the status indication of each switching channel can be configured for the entire device. The Status indication sends the switching status of the individual output contact on the KNX bus.

■ **Logic block**

The Logic function is used to control an output depending on the result of a logic operation. This command has the lowest priority. The result of the function can be output on the KNX bus and can directly control one or more outputs. There are 2 logic blocks per device with up to 4 inputs available.

■ **Diagnosis**

The Device diagnosis function allows notifications about the operating state of the device to be sent via the KNX bus. This information is sent periodically and/or on status change.

■ **Communication objects**

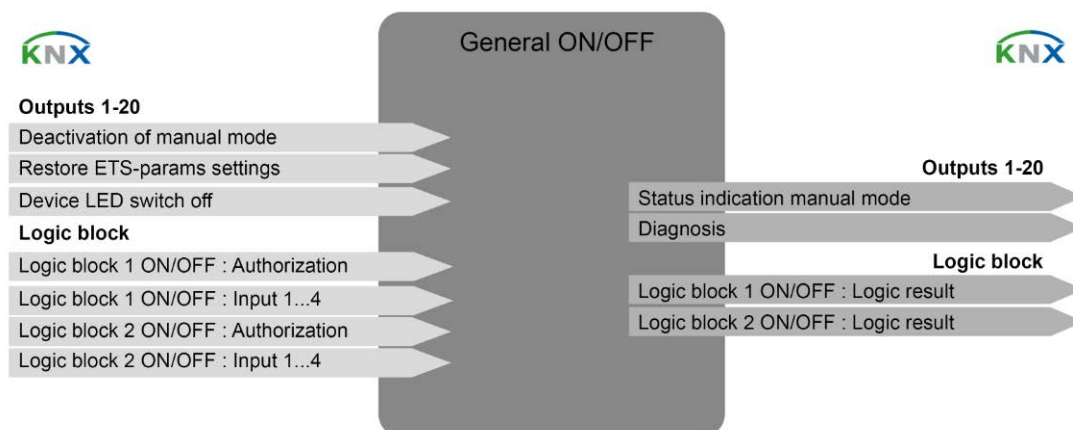

2.2.2 Shutter/blind

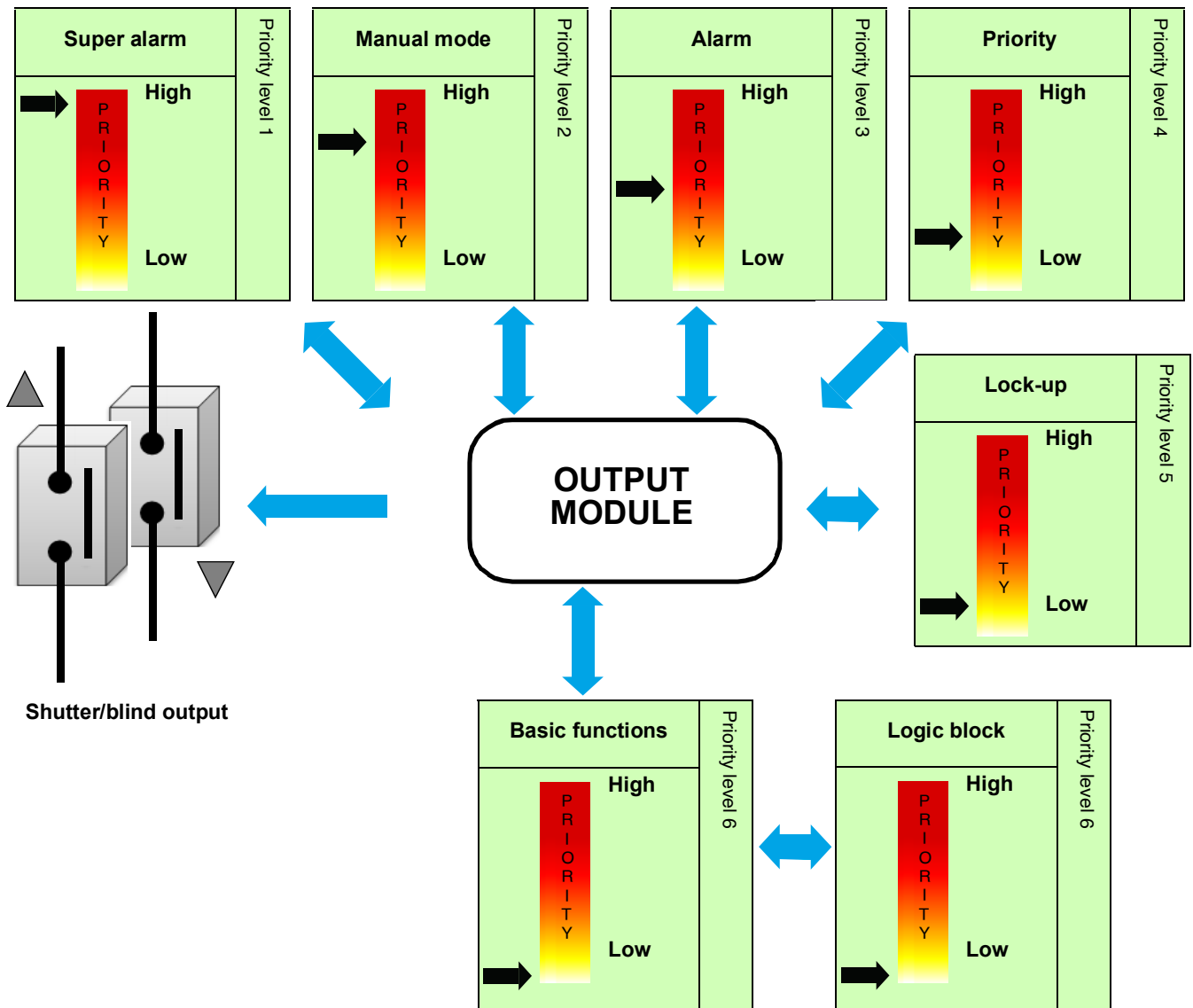

2.2.2.1 Functions for each shutter/blind channel

The applications allow individual configuration of the device outputs. The most important functions are:

■ Up/down

The UP/DOWN function is used to run up or down shutters, blinds, awnings, etc. This function can also be used to open and close electric blinds. The command can be given by touch sensors (long press), switches or automatically.

■ Slat position/Stop

The Slat position/Stop function is used to adjust the slats of a blind or to stop its ongoing movement. This function can be used to alter the shade and the incidence of light from outside. The control command may be issued by a push button, for example: A short press on UP/DOWN buttons.

■ Position in %

The Position function is used to bring a shutter or blind to a desired position, which is entered in % lock.

■ Scene

The Scene function is used to switch groups of outputs into a configurable predefined state. A scene is activated by receipt of a 1-byte command. Pressing a push button activates a scene. Each output can be included in 64 different scenes.

■ Preset

The Preset function is used to switch an output into various predefined states. The Preset function is activated via an object in 1-bit format.

■ Sun protection

The Sun protection function is used to set the brightness in a room according to the amount of daylight. In general, the position values are sent by an external device (For example, a weather station).

■ Lock-up

The Lock-up function is used to lock the output in a predefined state.

Priority: Super alarm > Manual mode > Alarm > Priority > **Lock-up** > Basic function.

The Lock-up prevents actuation until an unlock command has been received. The Lock-up duration can be set.

■ Priority

The Priority function is used to force the output into a defined state.

Priority: Super alarm > Manual mode > Alarm > **Priority** > Lock-up > Basic function.

Only a Priority OFF command authorizes the output for control.

Application: Maintaining a hanging position for security reasons.

■ Alarm

With the Alarm function a shutter or blind can be positioned in a configurable predefined state. Up to 3 alarm functions are possible.

Priority: Super alarm > Manual mode > **Alarm** > Priority > Lock-up > Basic function.

The alarm prevents any actuation until an alarm cancellation command has been received.

* Default value

■ Communication objects

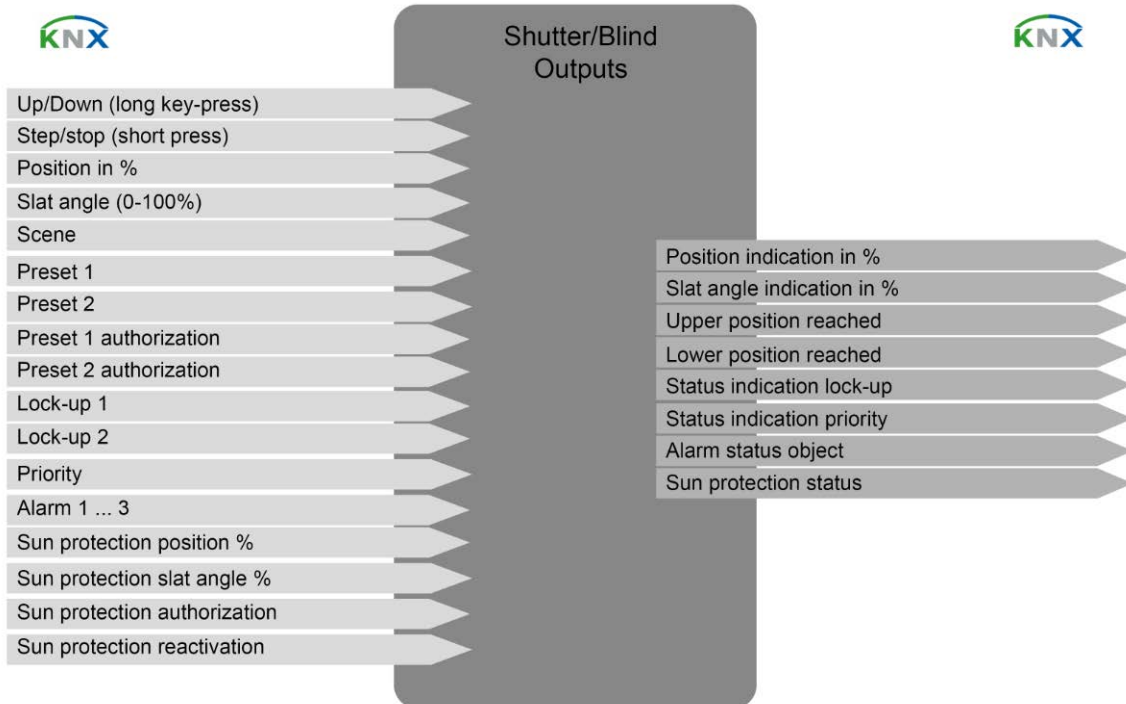

2.2.2.2 Additional functions

The applications configure the general functions of the devices. The following functions apply to the entire device:

■ **Super alarm**

This function is used to set all the outputs of the device into a configurable blocked state. All other functions, including manual mode, will be locked. Only a command to cancel the Super alarm will authorize the other commands.

Application: Block all blinds for window cleaning.

■ **Manual mode**

Manual mode allows the device to be disconnected from the bus. In this mode, each output can be priority controlled locally. The duration of the manual control can be configured.

■ **Status indication**

The behaviour of the Status indication of each shutter/blind channel can be configured for the entire device.

Using the Status indication function, the following can be sent via the bus:

- Position in % indication: Indicates the position of the shutter or blind.
- Slat angle indication in %: Indicates the slat pitch of the blind.
- Upper or lower position reached: Indicates arrival at the upper or lower position.

■ **Logic block**

The Logic function is used to control an output depending on the result of a logic operation. This command has the lowest priority. The result of the function can be output on the KNX bus and can directly control one or more outputs. There are 2 logic blocks per device with up to 4 inputs available.

■ **Diagnosis**

The Device diagnosis function allows notifications about the operating state of the device to be sent via the KNX bus. This information is sent periodically and/or on status change.

■ **Communication objects**

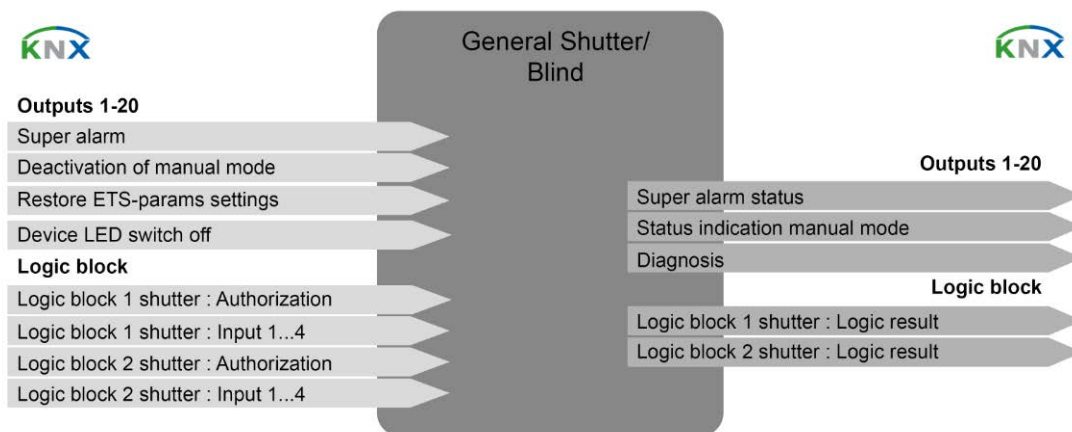

* Default value

3. Parameters

3.1 Closing type for the outputs

This configuration window is used to set the Closing type for the outputs.
Parameter description:

ON/OFF

- Each switching contact is used separately to switch a load.

Shutter/blind

- Each pair of outputs constitutes a shutter and blind channel.

The screenshot shows a configuration window titled "Outputs 1-20: Function". It lists functions from 01-02 to 019-020. For each function, there are two radio buttons: "ON/OFF" and "Shutter and blind". The "Shutter and blind" option is selected for all functions shown.

Function	ON/OFF	Shutter and blind
Function 01-02	<input type="radio"/>	<input checked="" type="radio"/>
Function 03-04	<input checked="" type="radio"/>	<input type="radio"/>
Function 05-06	<input checked="" type="radio"/>	<input type="radio"/>
Function 07-08	<input checked="" type="radio"/>	<input type="radio"/>
Function 09-010	<input checked="" type="radio"/>	<input type="radio"/>
Function 011-012	<input checked="" type="radio"/>	<input type="radio"/>
Function 013-014	<input checked="" type="radio"/>	<input type="radio"/>
Function 015-016	<input checked="" type="radio"/>	<input type="radio"/>
Function 017-018	<input checked="" type="radio"/>	<input type="radio"/>
Function 019-020	<input checked="" type="radio"/>	<input type="radio"/>

Parameter	Description	Value
Function Ox-Oy	The outputs are used as ON/OFF switches. The outputs are used for shutters and blinds. One output for raising and one output for lowering.	ON/OFF* Shutter and blind

The assignment of the outputs is carried out following:

	ON/OFF	Shutter and blind
Function 01-02	Output 1: ON/OFF Output 2: ON/OFF	Output 1-2: Shutter and blind
Function 03-04	Output 3: ON/OFF Output 4: ON/OFF	Output 3-4: Shutter and blind
Function 05-06	Output 5: ON/OFF Output 6: ON/OFF	Output 5-6: Shutter and blind
Function 07-08	Output 7: ON/OFF Output 8: ON/OFF	Output 7-8: Shutter and blind
Function 09-010	Output 9: ON/OFF Output 10: ON/OFF	Output 9-10: Shutter and blind
Function 011-012	Output 11: ON/OFF Output 12: ON/OFF	Output 11-12: Shutter and blind
Function 013-014	Output 13: ON/OFF Output 14: ON/OFF	Output 13-14: Shutter and blind
Function 015-016	Output 15: ON/OFF Output 16: ON/OFF	Output 15-16: Shutter and blind

* Default value

Function O17-O18	Output 17: ON/OFF Output 18: ON/OFF	Output 17-18: Shutter and blind
Function O19-O20	Output 19: ON/OFF Output 20: ON/OFF	Output 19-20: Shutter and blind



Information

The number of outputs may change depending on the type of device used.

* Default value

3.2 Definition of the general parameters

This configuration window is used for general configuration of the device.

Outputs 1-20: Function	Function ON/OFF	
Outputs 1-20: General	Manual mode	Active
- 01-20: Manual mode ON/OFF	Status indication	<input checked="" type="checkbox"/>
- 01-20: Status indications ON/OFF	Logic block 1	<input type="checkbox"/>
- 01-20: Manual mode shutter	Logic block 2	<input type="checkbox"/>
- 01-20: Status indications shutter	Status at bus return	Maintain status
	Status after ETS download	Maintain status
+ Outputs 1-2	Function shutter/blind	
+ Output 3	Super alarm	Not active
+ Output 4	Manual mode	Active
+ Output 5	Logic block 1	<input type="checkbox"/>
+ Output 6	Logic block 2	<input type="checkbox"/>
+ Output 7	Status at bus return	Maintain status
+ Output 8	Status after ETS download	Maintain status
+ Output 9	Device diagnosis object	<input type="checkbox"/>
+ Output 10	Activ. of restore ETS-parameters object (scenes, timer, setpoints)	<input type="checkbox"/>
+ Output 11	Parameters overwrite at next download (scenes, timer, setpoints)	<input checked="" type="checkbox"/>
+ Output 12	Device LED switch off object	<input type="checkbox"/>

* Default value

3.2.1 Activation of manual mode: ON/OFF

Parameter	Description	Value
Manual mode	Switching to manual mode is not possible.	Not active
	Switching to manual mode is possible without time limit.	Active*
	Manual mode can be activated for a duration that is configurable via the ETS parameters. After expiry of the time limit, manual mode is no longer active.	Time limited

For configuration see section: [Manual mode: ON/OFF](#).

3.2.2 Activation of the Status indication: ON/OFF

Parameter	Description	Value
Status indication	The Status indications parameter register is hidden.	Not active
	The Status indications parameter register is displayed.	Active*

For configuration see section: [Status indication ON/OFF](#).

3.2.3 Activation of the logic blocks: ON/OFF

Parameter	Description	Value
Logic block 1	Communication object and parameter register Logic block 1 are hidden.	Not active*
	Communication object and parameter register Logic block 1 are displayed.	Active

For configuration see section: [Logic block : ON/OFF](#).

Note: The parameters and objects are identical for block 2 ; Only the terms will be adjusted.

For logic block 1

Communication objects: [404 - Logic block 1 ON/OFF - Input 1 \(1 bit - 1.002 DPT_Bool\)](#)
[408 - Logic block 1 ON/OFF - Logic result \(1 bit - 1.002 DPT_Bool\)](#)

For logic block 2

Communication objects: [410 - Logic block 2 ON/OFF - Input 1 \(1 bit - 1.002 DPT_Bool\)](#)
[414 - Logic block 2 ON/OFF - Logic result \(1 bit - 1.002 DPT_Bool\)](#)

* Default value

3.2.4 Status during bus power cut or download: ON/OFF

Parameter	Description	Value
Status during bus power cut	The output status remains unchanged during a bus power cut.	Maintain status*
	The output is turned on when there is a bus power cut.	ON
	The output is turned off when there is a bus power cut.	OFF

Parameter	Description	Value
Status at bus return	The output status remains unchanged during at bus return.	Maintain status*
	The output is switched on at bus return.	ON
	The output is switched off at bus return.	OFF

Note: The device will reboot on bus return. The Priority functions that were present before the bus power cut, are no longer active (Priority, Lock-up).

Parameter	Description	Value
Status after ETS download	The output status remains unchanged after ETS download.	Maintain status*
	The output is switched on after ETS download.	ON
	The output is switched off after ETS download.	OFF

Note: During ETS-parameters download, the outputs remain unchanged.

3.2.5 Super alarm: Shutter

Parameter	Description	Value
Super alarm	Activation of the Super alarm is not possible.	Not active
	Activation of the Super alarm is possible without time limit.	Active*
	The Super alarm can be activated for a duration that is configurable via the ETS parameters.	Time limited
	After expiry of the time limit, the Super alarm is no longer active.	

Communication objects: [415 - Outputs 1-20 - Super alarm \(1 bit - 1.005 DPT_Alarm\)](#)

For configuration see section: [Super alarm](#).

* Default value

3.2.6 Activation of manual mode: Shutter

Parameter	Description	Value
Manual mode	Switching to manual mode is not possible.	Not active*
	Switching to manual mode is possible without time limit.	Active
	Manual mode can be activated for a duration that is configurable via the ETS parameters.	Time limited
	After expiry of the time limit, manual mode is no longer active.	

For configuration see section: [Manual mode: Shutter](#).

3.2.7 Activation of the Status indication: Shutter

Parameter	Description	Value
Status indication	The Status indications parameter register is hidden.	Not active
	The Status indications parameter register is displayed.	Active*

For configuration see section: [Status indication Shutter](#).

3.2.8 Activation of the logic blocks: Shutter

Parameter	Description	Value
Logic block 1	Communication object and parameter register Logic block 1 are hidden.	Not active*
	Communication object and parameter register Logic block 1 are displayed.	Active

For configuration see section: [Logic block : Shutter](#).

Note: The parameters and objects are identical for block 2 ; Only the terms will be adjusted.

For logic block 1

Communication objects: [420 - Logic block 1 shutter - Input 1 \(1 bit - 1.002 DPT_Bool\)](#)
[424 - Logic block 1 shutter - Logic result \(1 bit - 1.002 DPT_Bool\)](#)

For logic block 2

Communication objects: [426 - Logic block 2 shutter - Input 1 \(1 bit - 1.002 DPT_Bool\)](#)
[430 - Logic block 2 shutter - Logic result \(1 bit - 1.002 DPT_Bool\)](#)

3.2.9 Status during bus power cut or download: Shutter

Parameter	Description	Value
Status during bus power cut	Maintain the position before the bus power cut. Shutter or blind open. Shutter or blind closed.	Maintain status* Up Down

Parameter	Description	Value
Status after bus power cut	Maintain the position before the bus power cut. Shutter or blind open. Shutter or blind closed. Run to a specific position.	Maintain status* Up Down Specific position

Note: The device will reboot on bus return. The priority functions that were present before the bus power cut, are no longer active (Super alarm, Alarm, Priority, Lock-up).

Parameter	Description	Value
Position after bus power cut	This parameter defines the position to run the shutter or blind to, after the KNXbus power cut.	0 ... 5* ... 100

*Note: This parameter is only visible if the **Status after bus power cut** parameter has the following value: **Specific position**.*

Parameter	Description	Value
Slat angle (0-100%)	This parameter defines the slat position of the blind that is set after a KNX bus power cut.	0 ... 5* ... 100

*Note: This parameter is only visible if the **Status after bus power cut** parameter has the following value: **Specific position**.*

Parameter	Description	Value
Status after ETS download	Maintain the position before download. Shutter or blind open. Shutter or blind closed. Run to a specific position.	Maintain status* Up Down Specific position

Note: During ETS-parameters download, the outputs remain unchanged.

Parameter	Description	Value
Position after download	This parameter defines the position to run the shutter or blind to, after download of the ETS parameters.	0 ... 5* ... 100

*Note: This parameter is only visible if the **Status after download** parameter has the following value: **Specific position**.*

Parameter	Description	Value
Slat angle (0-100%)	This parameter defines the slat position of the blind that is set after download of the ETS-parameters.	0 ... 5* ... 100

*Note: This parameter is only visible if the **Status after download** parameter has the following value: **Specific position**.*

* Default value

3.2.10 Restore ETS-Parameters

There are 2 types of parameters in the device:

- Parameters that can only be changed via ETS.
- Parameters that can be changed via ETS or via the KNX bus.

For parameters that can be changed via ETS and via the KNX bus, 2 values are stored in the device memory: The value corresponding to the ETS-parameter and the currently used value.

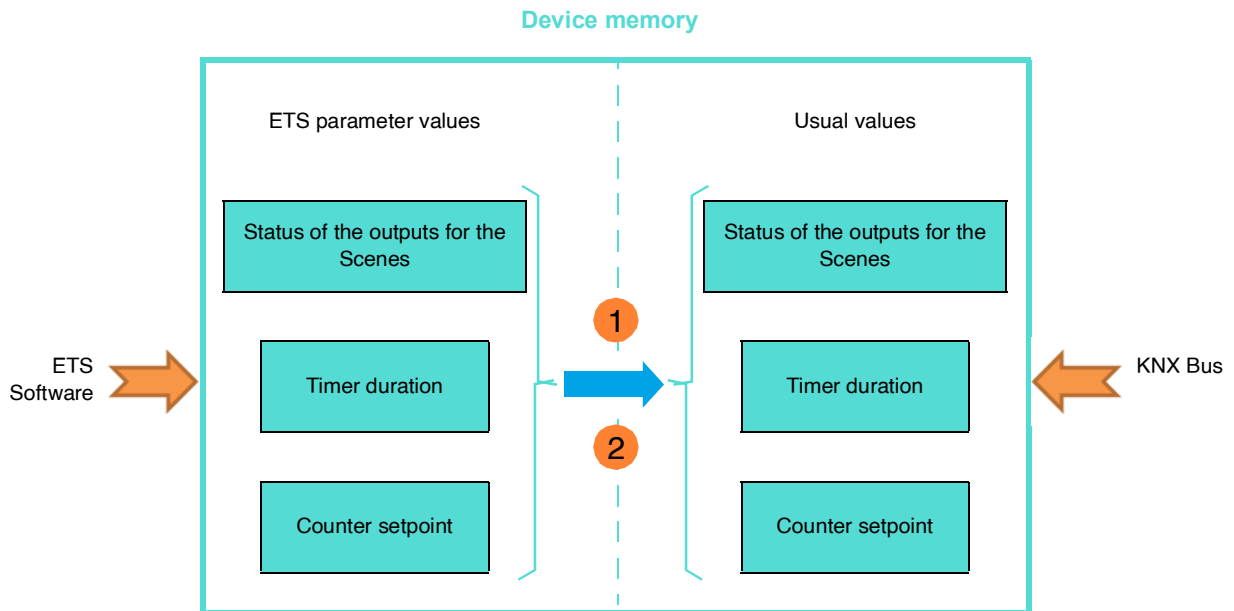

- 1 Receipt of the value 1 on the object, Resets the ETS parameter values:** Current parameter values are replaced by the ETS-parameter values.
- 2 Download of the ETS application:** Current parameter values are replaced by the ETS parameter values on download.

Parameter	Description	Value
Activ. of restore ETS-parameters object (scenes, timer, setpoints)	The Restore ETS-params settings communication object is hidden.	Not active*
	The Restore ETS-params settings communication object is displayed.	Active
	On receipt of a 1 on this object, the parameters** that are adjustable via the bus are overwritten with values set in the ETS before the last download.	

** Output status for scene X, Timer duration, Hours counter setpoint, Current setpoint 1 and 2, Counter value setpoint.

Communication object: [431 - Outputs 1-20 - Restore ETS-params settings \(1 bit - 1.015 DPT_Reset\)](#)

* Default value

3.2.11 Activation of the Device diagnosis object

Parameter	Description	Value
Device diagnosis object	The Device diagnosis parameter register and the associated communication object is hidden.	Not active*
	The Device diagnosis parameter register and the associated communication object are displayed.	Active

Communication object: [433 - Outputs 1-20 - Diagnosis \(6 byte - Specific\)](#)

For configuration see section: [Diagnosis](#).

3.2.12 Parameters overwrite at next download

Parameter	Description	Value
Parameters overwrite at next download (scenes)	The parameter values stored in the device will remain in the device at the next download.	Not active*
	The parameter values stored in the device will be overwritten with the ETS configured values at the next download.	Active

3.2.13 LED display

Parameter	Description	Value
Device LED switch off object	The Device LEDs lock-up communication object is hidden.	Not active*
	The Device LEDs lock-up communication object is displayed.	Active

This function is used to reduce the overall power consumption of the device. It allows the LEDs on the front of the device to be switched off.

Communication object: [432 - Outputs 1-20 - Device LED switch off \(1 bit - 1.001 DPT_Switch\)](#)

Parameter	Description	Value
Polarity	Object Device LED lock receives: 0 = The LED display is activated 1 = The LED display is deactivated 0 = The LED display is deactivated 1 = The LED display is activated	0 = Status indication, 1 = Always OFF* 0 = Always OFF, 1 = Status indication

*Note: This parameter is only visible if the parameter **Device LED switch off object** has the following value: **Active**.*

* Default value

3.3 Super alarm

This function is used to block all the outputs of the device in a configurable state. All other functions, including manual mode, will be locked. Only a command to cancel the Super alarm will authorize the other commands. The super alarm is activated on receipt of a 1 on the **Super alarm** communication object.

The behaviour is determined by the following parameters:

Outputs 1-20: Function	WARNING!!! The super alarm locks-up device	
Outputs 1-20: General	functions, manual mode included	
- O1-20: Manual mode ON/OFF	Position during super alarm	Maintain status
- O1-20: Status indications ON/OFF	Super alarm status object	<input checked="" type="checkbox"/>
- O1-2: Super alarm shutter	Polarity	<input checked="" type="radio"/> 0 = deactivated, 1 = activated <input type="radio"/> 0 = activated, 1 = deactivated
- O1-20: Manual mode shutter	Emission	On status change
- O1-20: Status indications shutter	Alarm monitoring period	<input checked="" type="checkbox"/>
+ Outputs 1-2	Hours	0 h
+ Output 3	Minutes	30 min
+ Output 4	Seconds	0 s
	Position after super alarm	Maintain status

3.3.1 Duration activation and position

Parameter	Description	Value
Duration of super alarm	This parameter defines the time during which the super alarm is active.	12 hours: 0 to 23 h 0 minutes: 0 to 59 min 0 seconds: 0 to 59 s

Note: The smallest executable time is 1 second.

*Note: This parameter is only visible if the **Super alarm** parameter has the following value: **Time limited**.*

* Default value

Parameter	Description	Value
Position during super alarm	During the super alarm, the shutter/blind output: Not changed. Closes the Up contact. Closes the down contact. Opens the 2 contacts. Runs to a specific position. Runs to a position set in a scene.	Maintain status* Up Down Stop Specific position Scene number

Parameter	Description	Value
Position (0-100%)	This parameter defines the position to run the shutter or blind to during the super alarm.	0 ... 5* ... 100

*Note: This parameter is only visible if the **Position during super alarm** parameter has the following value: **Specific position**.*

Parameter	Description	Value
Slat angle (0-100%)	This parameter defines the slat position of the blind that is set during the super alarm.	0 ... 5* ... 100

*Note: This parameter is only visible if the **Position during super alarm** parameter has the following value: **Specific position**.*

Parameter	Description	Value
Scene	This parameter defines the scene number that is to be applied during the super alarm.	Scene 1 ... 64 Default value: 1

The outputs respond according to the scene numbers and associated parameters.

*Note: This parameter is only visible if the **Position during super alarm** parameter has the following value: **Scene number**.*

3.3.2 Super alarm status indication

Parameter	Description	Value
Super alarm status object	This parameter is used to authorize the Super alarm status object. This object allows the status of the super alarm to be sent from the device on the KNX bus.	Not active* Active

Communication object: [416 - Outputs 1-20: Shutter - Super alarm status \(1 bit - 1.011 DPT_State\)](#)

Parameter	Description	Value
Polarity	The Super alarm status object sends: 0 = When the super alarm is deactivated 1 = When the super alarm is activated 0 = When the super alarm is activated 1 = When the super alarm is deactivated	0 = Not active, 1 = Active* 0 = Active, 1 = Not active

*Note: This parameter is only visible if the **Super alarm status indication object** parameter has the following value: **Active**.*

Parameter	Description	Value
Emission	The object Super alarm status will be sent on: Activation or deactivation of the super alarm. Periodically after a configurable time. On activation or deactivation of the super alarm and periodically.	On status change* Periodically On status change and periodically

*Note: This parameter is only visible if the **Super alarm status indication object** parameter has the following value: **Active**.*

Parameter	Description	Value
Hours (h)	This parameter determines the time between the individual transmissions of the Super alarm status object.	0 hours: 0 to 23 h
Minutes (min)		10 minutes: 0 to 59 min
Seconds (s)		0 seconds: 0 to 59 s

Note: The smallest executable time is 1 second.

*Note: This parameter is only visible if the **Emission** parameter has the following value: **Periodically** or **On status change and periodically**.*

* Default value

3.3.3 Alarm monitoring period

Parameter	Description	Value
Alarm monitoring period	<p>The Super alarm object:</p> <p>Expects no periodic signal.</p> <p>Expects a periodic 0 signal.</p> <p>If this signal remains off, the super alarm is automatically activated and the shutters/blinds are run to the position set by the Position during super alarm parameter.</p>	<p>Not active*</p> <p>Active</p>

Parameter	Description	Value
Hours (h)	This parameter defines the maximum time between 2 signals on the Super alarm communication object.	0 hours: 0 to 23 h
Minutes (min)		10 minutes: 0 to 59 min
Seconds (s)		0 seconds: 0 to 59 s

Note: The smallest executable time is 1 second.

*Note: This parameter is only visible if the **Alarm monitoring period** parameter has the following value: **Active**.*

3.3.4 Position after super alarm

Parameter	Description	Value
Position after super alarm	<p>After the super alarm, the shutter/blind output:</p> <p>Not changed.</p> <p>Closes the Up contact.</p> <p>Closes the down contact.</p> <p>Runs to a specific position.</p> <p>Runs to a position set in a scene.</p> <p>Returns to the position before super alarm.</p> <p>Runs to the position that would be active according to other communication objects if no super alarm had taken place.</p>	<p>Maintain status*</p> <p>Up</p> <p>Down</p> <p>Specific position</p> <p>Scene number</p> <p>Position before super alarm</p> <p>Theoretical status without super alarm</p>

*Note: On setting the **Theoretical status without super alarm**, the Up/Down and slat step commands are not saved.*

Parameter	Description	Value
Position (0-100%)	This parameter defines the position to run the shutter or blind to after the super alarm.	0 ... 5* ... 100

*Note: This parameter is only visible if the **Position after super alarm** parameter has the following value: **Specific position**.*

* Default value

Parameter	Description	Value
Slat angle (0-100%)	This parameter defines the slat position that is to be applied after the super alarm.	0 ... 5* ... 100

*Note: This parameter is only visible if the **Position after super alarm** parameter has the following value: **Specific position**.*

Parameter	Description	Value
Scene	This parameter defines the scene number that is to be activated after the super alarm.	Scene 1 ... 64 Default value: 1

The outputs respond according to the scene numbers and associated parameters.

*Note: This parameter is only visible if the **Position after super alarm** parameter has the following value: **Scene number**.*

* Default value

3.4 Manual mode

In manual mode the device is disconnected from the KNX bus.

The function of the connected load can be checked using the manual mode button. Manual mode can only be activated using the switch on the front of the device. In this mode, telegrams arriving from the KNX bus are ignored.

When manual mode is activated, the status of the relays initially remains unchanged. Each time the manual mode button of an output is pressed, its status is switched over.

3.4.1 Manual mode: ON/OFF

The behaviour is determined by the following parameters:

Outputs 1-20: Function	Duration of manual mode activation	0 h
Outputs 1-20: General	Duration of manual mode activation	30 min
- O1-20: Manual mode ON/OFF	Duration of manual mode activation	0 s
- O1-20: Status indications ON/OFF	Object deactivation of manual mode	<input checked="" type="checkbox"/>
- O1-2: Super alarm shutter	Polarity	<input type="radio"/> 0=Manual mode locked-up, 1=Manual mode a... <input checked="" type="radio"/> 0=Manual mode authorized, 1=Manual mode l...
- O1-20: Manual mode shutter	Object status indication manual mode	<input checked="" type="checkbox"/>
- O1-20: Status indications shutter	Default Value: Unchecked Polarity	<input checked="" type="radio"/> 0=Manual mode deactivated, 1=Manual mode... <input type="radio"/> 0=Manual mode activated, 1=Manual mode de...
+ Outputs 1-2	Emission	On status change
+ Output 3	Status after manual mode	Maintain status
+ Output 4		

3.4.1.1 Manual mode activation period

Parameter	Description	Value
Duration of manual mode activation	This parameter defines the amount of time for which manual mode remains activated.	0 hours: 0 to 23 h 30 minutes: 0 to 59 min 0 seconds: 0 to 59 s

Note: The smallest executable time is 1 second.

Note: This parameter is only visible if the **Manual mode** parameter has the following value: **Time limited**.

* Default value

3.4.1.2 Deactivation of manual mode

Parameter	Description	Value
Object deactivation of manual mode	The Deactivation of manual mode communication object is hidden.	Not active*
	The Deactivation of manual mode communication object is displayed.	Active

Communication object: [401 - Outputs 1-20: ON/OFF - Deactivation of manual mode \(1 bit - 1.003 DPT_Enable\)](#)

Parameter	Description	Value
Polarity	The Deactivate manual mode object receives: 0 = Manual mode is activated 1 = Manual mode is not activated	0 = Manual mode authorized, 1 = Manual mode locked-up*
	0 = Manual mode is not activated 1 = Manual mode is activated	0 = Manual mode locked-up, 1 = Manual mode authorized

Note: This parameter is only visible if the **Object deactivation of manual mode** parameter has the following value: **Active**.

3.4.1.3 Status indication manual mode

Parameter	Description	Value
Object status indication manual mode	The Status indication manual mode communication object is hidden.	Not active*
	The Status indication manual mode communication object is displayed.	Active

Communication object: [402 - Outputs 1-20: ON/OFF - Status indication manual mode \(1 bit - 1.011 DPT_State\)](#)

Parameter	Description	Value
Polarity	The Status indication manual mode communication object sends: 0 = When manual mode is switched on 1 = When manual mode is switched off	0 = Manual mode active, 1 = Manual mode not active
	0 = When manual mode is switched off 1 = When manual mode is switched on	0 = Manual mode not active, 1 = Manual mode active*

Note: This parameter is only visible if the **Object status indication manual mode** parameter has the following value: **Active**.

Parameter	Description	Value
Emission	The Status indication manual mode communication object is sent: On switching manual mode on or off.	On status change*
	Periodically after a configurable time.	Periodically
	On switching manual mode on or off and periodically after a configurable time.	On status change and periodically

Note: This parameter is only visible if the **Object status indication manual mode** parameter has the following value: **Active**.

* Default value

Parameter	Description	Value
Hours (h)	This parameter determines the time between the individual transmissions of the Status indication manual mode object.	0 hours: 0 to 23 h
Minutes (min)		10 minutes: 0 to 59 min
Seconds (s)		0 seconds: 0 to 59 s

Note: The smallest executable time is 1 second.

*Note: This parameter is only visible if the **Emission** parameter has the following value: **Periodically** or **On status change and periodically**.*

3.4.1.4 Status after manual mode

Parameter	Description	Value
Status after manual mode	At the end of manual mode, the output status is: Not changed. Is switched to the opposite status. Selectively switched on. Selectively switched off. Switched back to the status before manual mode was activated. Switched to the status which would be active according to other communication objects if the manual mode had not taken place.	Maintain status* Inversion ON OFF Status before manual mode Theoretical status without manual mode

Note: The application of this parameter depends on the priority of the other active functions. If a function with higher priority is active, this parameter will not be enacted. In the case where two functions with the same priority are active, the parameter of the most recently switched off function is enacted.

3.4.2 Manual mode: Shutter

The behaviour is determined by the following parameters:

Outputs 1-20: Function	Duration of manual mode activation	<input type="text" value="0"/> h
Outputs 1-20: General	Duration of manual mode activation	<input type="text" value="30"/> min
- O1-20: Manual mode ON/OFF	Duration of manual mode activation	<input type="text" value="0"/> s
- O1-20: Status indications ON/OFF	Object deactivation of manual mode	<input checked="" type="checkbox"/>
- O1-2: Super alarm shutter	Polarity	<input type="radio"/> 0=Manual mode locked-up, 1=Manual mode a... <input checked="" type="radio"/> 0=Manual mode authorized, 1=Manual mode l...
- O1-20: Manual mode shutter		
- O1-20: Status indications shutter	Object status indication manual mode	<input checked="" type="checkbox"/>
	Default Value: Unchecked	
	Polarity	<input checked="" type="radio"/> 0=Manual mode deactivated, 1=Manual mode... <input type="radio"/> 0=Manual mode activated, 1=Manual mode de...
+ Outputs 1-2	Emission	<input type="text" value="On status change"/>
+ Output 3		
+ Output 4	Position after manual mode	<input type="text" value="Maintain status"/>

3.4.2.1 Manual mode activation period

Parameter	Description	Value
Duration of manual mode activation	This parameter defines the amount of time for which manual mode remains activated.	0 hours: 0 to 23 h 30 minutes: 0 to 59 min 0 seconds: 0 to 59 s

Note: The smallest executable time is 1 second.

Note: This parameter is only visible if the **Manual mode** parameter has the following value: **Time limited**.

3.4.2.2 Deactivation of manual mode

Parameter	Description	Value
Object deactivation of manual mode	The Deactivation of manual mode communication object is hidden.	Not active*
	The Deactivation of manual mode communication object is displayed.	Active

Communication object: [417 - Outputs 1-20: Shutter - Deactivation of manual mode \(1 bit - 1.003 DPT_Enable\)](#)

Parameter	Description	Value
Polarity	The Deactivate manual mode object receives: 0 = Manual mode is activated 1 = Manual mode is not activated 0 = Manual mode is not activated 1 = Manual mode is activated	0 = Manual mode authorized, 1 = Manual mode locked-up* 0 = Manual mode locked-up, 1 = Manual mode authorized

Note: This parameter is only visible if the **Object deactivation of manual mode** parameter has the following value: **Active**.

3.4.2.3 Status indication manual mode

Parameter	Description	Value
Object status indication manual mode	The Status indication manual mode communication object is hidden.	Not active*
	The Status indication manual mode communication object is displayed.	Active

Communication object: [418 - Outputs 1-20: Shutter - Status indication manual mode \(1 bit - 1.011 DPT_State\)](#)

Parameter	Description	Value
Polarity	The Status indication manual mode communication object sends: 0 = When manual mode is switched on 1 = When manual mode is switched off 0 = When manual mode is switched off 1 = When manual mode is switched on	0 = Manual mode active, 1 = Manual mode not active 0 = Manual mode not active, 1 = Manual mode active*

Note: This parameter is only visible if the **Object status indication manual mode** parameter has the following value: **Active**.

* Default value

Parameter	Description	Value
Emission	The Status indication manual mode communication object is sent: On switching manual mode on or off. Periodically after a configurable time. On switching manual mode on or off and periodically after a configurable time.	On status change* Periodically On status change and periodically

Note: This parameter is only visible if the **Object status indication manual mode** parameter has the following value: **Active**.

Parameter	Description	Value
Hours (h)	This parameter determines the time between the individual transmissions of the Status indication manual mode object.	0 hours: 0 to 23 h
Minutes (min)		10 minutes: 0 to 59 min
Seconds (s)		0 seconds: 0 to 59 s

Note: The smallest executable time is 1 second.

Note: This parameter is only visible if the **Emission** parameter has the following value: **Periodically** or **On status change and periodically**.

3.4.2.4 Status after manual mode

Parameter	Description	Value
Status after manual mode	After manual mode, the shutter/blind output: Not changed. Closes the Up contact. Closes the down contact. Runs to a specific position. Returns to the position before super alarm. Runs to the position that would be active according to other communication objects if no super alarm had taken place.	Maintain status* Up Down Specific position Position before manual mode Theoretical status without manual mode

On setting the **Theoretical status without super alarm**, the Up/Down and slat step commands are not saved.

Parameter	Description	Value
Position (0-100%)	This parameter defines the position to run the shutter or blind to after manual mode.	0 ... 5* ... 100

Note: This parameter is only visible if the **Status after manual mode** parameter has the following value: **Specific position**.

Parameter	Description	Value
Slat angle (0-100%)	This parameter specifies the slat position of the blinds that is to be set after the end of manual mode.	0 ... 5* ... 100

Note: This parameter is only visible if the **Status after manual mode** parameter has the following value: **Specific position**.

* Default value

3.5 Status indication

The status Indication function specifies the status of the output contact.

3.5.1 Status indication ON/OFF

Outputs 1-20: Function	Polarity	<input checked="" type="radio"/> 0 = OFF, 1 = ON <input type="radio"/> 0 = ON, 1 = OFF
Outputs 1-20: General	Emission during manual mode	<input checked="" type="checkbox"/>
- O1-20: Manual mode ON/OFF	Emission	On status change and periodically
- O1-20: Status indications ON/OFF	Hours	0 h
- O1-2: Super alarm shutter	Minutes	10 min
- O1-20: Manual mode shutter	Seconds	0 s
- O1-20: Status indications shutter	Emission after bus power return	0 h
+ Outputs 1-2	Emission after bus power return	0 min
	Emission after bus power return	20 s

Parameter	Description	Value
Polarity	The Status indication ON/OFF communication object sends: 0 = For an open output contact 1 = For a closed output contact 0 = For a closed output contact 1 = For an open output contact	0 = OFF, 1 = ON* 0 = ON, 1 = OFF

*Note: If the Blinking function is activated, the above parameter is ignored and replaced by the **Output status during Blinking function** parameter.*

Parameter	Description	Value
Emission during manual mode	The Status indication ON/OFF communication object sends: Values if the output status is switched in manual mode. No values if the output status is switched in manual mode.	Active* Not active

Parameter	Description	Value
Emission	The Status indication ON/OFF communication object is sent: On each output change. Periodically after a configurable time. On output change and periodically after a configurable time.	On status change* Periodically On status change and periodically

* Default value

Parameter	Description	Value
Hours (h)	This parameter determines the time between the individual transmissions of the Status indication ON/OFF object.	0 hours: 0 to 23 h
Minutes (min)		10 minutes: 0 to 59 min
Seconds (s)		0 seconds: 0 to 59 s

Note: The smallest executable time is 1 second.

*Note: This parameter is only visible if the **Emission** parameter has the following value: **Periodically** or **On status change and periodically**.*

Parameter	Description	Value
Emission after bus power return	This parameter determines the delay for emission of the Status indication ON/OFF object on return of the KNX bus after a power cut.	0 hours: 0 to 23 h 0 minutes: 0 to 59 min 20 seconds: 0 to 59 s

Note: The smallest executable time is 1 second.

Note: This parameter can be used to optimize the bus load after the return of the KNX bus voltage.

* Default value

3.5.2 Status indication Shutter

Using the Status indication function, the following can be sent via the bus:

- Position in % indication: Indicates the position of the shutter or blind.
- Slat angle indication in %: Indicates the slat pitch of the blind.
- Upper or lower position reached: Indicates that the shutter or blind has reached the upper or lower position.

The conditions for emission of the object values are on a change in the output, periodically or both of these simultaneously.

Outputs 1-20: Function	Position in % objects	
Outputs 1-20: General	Emission during manual mode	<input type="checkbox"/>
- O1-20: Manual mode ON/OFF	Emission	On status change
- O1-20: Status indications ON/OFF	Time delay for position objects	0 h
- O1-2: Super alarm shutter	Time delay for position objects	0 min
- O1-20: Manual mode shutter	Time delay for position objects	20 s
- O1-20: Status indications shutter	Slat angle in % objects	
+ Outputs 1-2	Emission during manual mode	<input type="checkbox"/>
+ Output 3	Emission	On status change
+ Output 4	Time delay for slat angle objects	0 h
+ Output 5	Time delay for slat angle objects	0 min
+ Output 6	Time delay for slat angle objects	20 s
+ Output 7	Upper position reached objects	
+ Output 8	Polarity	<input checked="" type="radio"/> 0 = Position not reached, 1 = Position reached <input type="radio"/> 0 = Position reached, 1 = Position not reached
+ Output 9	Emission during manual mode	<input type="checkbox"/>
+ Output 10	Emission	On status change
+ Output 11	Time delay for upper position objects	0 h
+ Output 12	Time delay for upper position objects	0 min
+ Output 13	Time delay for upper position objects	20 s
+ Output 14	Lower position reached objects	
+ Output 15	Polarity	<input checked="" type="radio"/> 0 = Position not reached, 1 = Position reached <input type="radio"/> 0 = Position reached, 1 = Position not reached
+ Output 16	Emission during manual mode	<input type="checkbox"/>
+ Output 17	Emission	On status change
+ Output 18	Time delay for lower position objects	0 h
+ Output 19	Time delay for lower position objects	0 min
+ Output 20	Time delay for lower position objects	20 s
+ Information		

3.5.2.1 Position in % indication object

Parameter	Description	Value
Position in % objects	This parameter is used to display all the Position in % indication object related parameters.	Active* Not active

Parameter	Description	Value
Emission position objects during manual mode	The Position in % indication object sends: Values after a change of position in manual mode. No values after a change of position in manual mode.	Active Not active*

* Default value

Parameter	Description	Value
Emission	The Position in % indication communication object is sent: After each position change. Periodically after a configurable time. After a position change and periodically after a configurable time.	On status change* Periodically On status change and periodically

Parameter	Description	Value
Hours (h)	This parameter determines the time between the individual transmissions of the Position in % indication object.	0 hours: 0 to 23 h
Minutes (min)		30 minutes: 0 to 59 min
Seconds (s)		0 seconds: 0 to 59 s

Note: The smallest executable time is 1 second.

Note: This parameter is only visible if the **Emission** parameter has the following value: **Periodically** or **On status change and periodically**.

Parameter	Description	Value
Time delay for position objects	This parameter determines the delay for emission of the Position in % indication object on return of the KNX bus after a power cut.	1 hours: 0 to 23 h 0 minutes: 0 to 59 min 0 seconds: 0 to 59 s

Note: The smallest executable time is 1 second.

Note: This parameter can be used to optimize the bus load after the return of the KNX bus voltage.

3.5.2.2 Slat angle in % objects

Parameter	Description	Value
Slat angle in % objects	This parameter is used to display all the Slat angle indication in % object related parameters.	Active* Not active

Parameter	Description	Value
Emission during manual mode	The Slat angle indication in % object sends: Values after a change of position in manual mode. No values after a change of position in manual mode.	Active Not active*

Parameter	Description	Value
Emission	The Slat angle indication in % communication object is sent: After each position change. Periodically after a configurable time. After a position change and periodically after a configurable time.	On status change* Periodically On status change and periodically

Parameter	Description	Value
Hours (h)	This parameter determines the time between the individual transmissions of the Slat angle indication in % objects.	0 hours: 0 to 23 h
Minutes (min)		30 minutes: 0 to 59 min
Seconds (s)		0 seconds: 0 to 59 s

Note: The smallest executable time is 1 second.

Note: This parameter is only visible if the **Emission** parameter has the following value: **Periodically** or **On status change and periodically**.

Parameter	Description	Value
Time delay for slat angle objects	This parameter determines the delay for emission of the Slat angle indication in % object on return of the KNX bus after a power cut.	0 hours: 0 to 23 h 0 minutes: 0 to 59 min 10 seconds: 0 to 59 s

Note: The smallest executable time is 1 second.

Note: This parameter can be used to optimize the bus load after the return of the KNX bus voltage.

3.5.2.3 Upper position reached object

Parameter	Description	Value
Upper position reached objects	This parameter is used to display all the Upper position reached object related parameters.	Active Not active*

Parameter	Description	Value
Polarity	The Upper position reached object sends: 0 on leaving the upper position 1 on reaching the upper position 0 on reaching the upper position 1 on leaving the upper position	0 = Position not reached, 1 = Position reached* 0 = Position reached, 1 = Position not reached

Parameter	Description	Value
Emission during manual mode	The Upper position reached object sends: Values on reaching the end position in manual mode. No values on reaching the end position in manual mode.	Active Not active*

Parameter	Description	Value
Emission	The Upper position reached object sends: On reaching or leaving the final position. Periodically after a configurable time. After a position change and periodically after a configurable time.	On status change* Periodically On status change and periodically

* Default value

Parameter	Description	Value
Hours (h)	This parameter determines the time between the individual transmissions of the Upper position reached object.	0 hours: 0 to 23 h
Minutes (min)		30 minutes: 0 to 59 min
Seconds (s)		0 seconds: 0 to 59 s

Note: The smallest executable time is 1 second.

*Note: This parameter is only visible if the **Emission** parameter has the following value: **Periodically** or **On status change and periodically**.*

Parameter	Description	Value
Time delay for upper position objects	This parameter determines the delay for emission of the Upper position reached object on return of the KNX bus after a power cut.	0 hours: 0 to 23 h 0 minutes: 0 to 59 min 20 seconds: 0 to 59 s

Note: The smallest executable time is 1 second.

Note: This parameter can be used to optimize the bus load after the return of the KNX bus voltage.

3.5.2.4 Lower position reached object

Parameter	Description	Value
Lower position reached objects	This parameter is used to display all the Lower position reached object related parameters.	Active Not active*

Parameter	Description	Value
Polarity	The Lower position reached object sends: 0 on leaving the lower position 1 on reaching the lower position 0 on reaching the lower position 1 on leaving the lower position	0 = Position not reached, 1 = Position reached* 0 = Position reached, 1 = Position not reached

Parameter	Description	Value
Emission during manual mode	The Lower position reached object sends: Values on reaching the end position in manual mode. No values on reaching the end position in manual mode.	Active Not active*

* Default value

Parameter	Description	Value
Emission	The Lower position reached communication object is sent: On reaching or leaving the final position. Periodically after a configurable time. After a position change and periodically after a configurable time.	On status change* Periodically On status change and periodically

Parameter	Description	Value
Hours (h)	This parameter determines the time between the individual transmissions of the Lower position reached object.	0 hours: 0 to 23 h
Minutes (min)		30 minutes: 0 to 59 min
Seconds (s)		0 seconds: 0 to 59 s

Note: The smallest executable time is 1 second.

*Note: This parameter is only visible if the **Emission** parameter has the following value: **Periodically** or **On status change and periodically**.*

Parameter	Description	Value
Time delay for lower position objects	This parameter determines the delay for emission of the Lower position reached object on return of the KNX bus after a power cut.	0 hours: 0 to 23 h 0 minutes: 0 to 59 min 20 seconds: 0 to 59 s

Note: The smallest executable time is 1 second.

Note: This parameter can be used to optimize the bus load after the return of the KNX bus voltage.

* Default value

3.6 Logic block

The Logic function is used to control an output depending on the result of a logic operation. This command has the lowest priority. The result of the function can be output on the KNX bus and may directly relate to the status of one or more outputs. 2 logic blocks are available for each device.

Operating principle of the logic block:

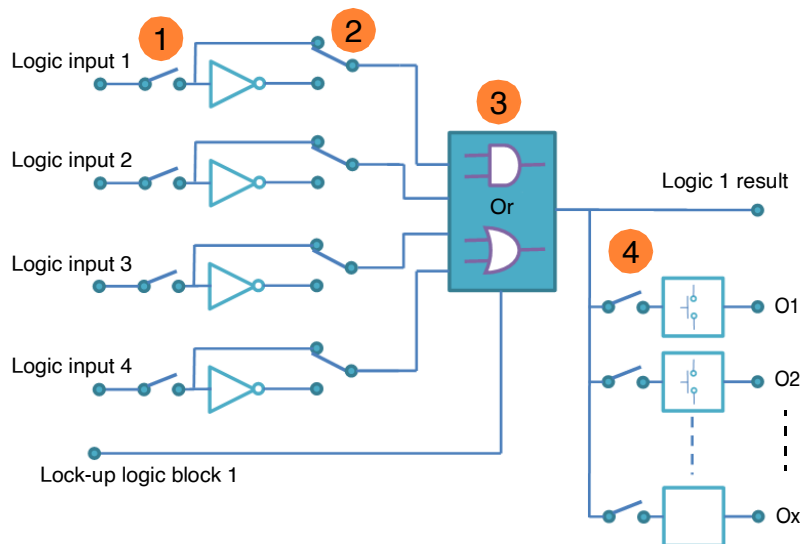

- ❶ Logic input number: Allows authorization of the logic input
- ❷ Logic input value: Inverted, yes or no
- ❸ Type of logic function (AND or OR): Selection of the logic function
- ❹ The logic result is applied to outputs: Selection of the outputs concerned by the logic operation

* Default value

3.6.1 Logic block : ON/OFF

The behaviour is determined by the following parameters:

Note: The description of the parameters is given for logic block 1. The parameters and objects are identical for logic block 2 ; Only the terms will be adjusted.

Outputs 1-20: Function	Logic function type	<input type="radio"/> And <input checked="" type="radio"/> Or
Outputs 1-20: General	Number of logic inputs	1
- O1-20: Status indications ON/OFF	Inverting value of logic input 1	<input checked="" type="radio"/> Maintain status <input type="radio"/> Status inversion
- O1-20: Logic block 1 ON/OFF	Value at initialization of logic input 1	Value before initialization
- O1-20: Logic block 2 ON/OFF	Authorization object logic block	<input checked="" type="checkbox"/>
- O1-20: Status indications shutter	Value at initialization	Value before initialization
+ Outputs 1-2	Polarity	<input checked="" type="radio"/> 0 = Locked-up , 1 = Authorized <input type="radio"/> 0 = Authorized, 1 = Locked-up
+ Output 3	Logic result after autorisation	<input checked="" type="radio"/> Immediate emission when authorization <input type="radio"/> No immediate emission
+ Output 4	Emission of logic result	<input type="radio"/> By input value change <input checked="" type="radio"/> By logic result value change
+ Output 5	Logic result acts on outputs	<input checked="" type="checkbox"/>
+ Output 6	Output 3	<input checked="" type="checkbox"/>
+ Output 7	Output 4	<input checked="" type="checkbox"/>
+ Output 8	Output 5	<input checked="" type="checkbox"/>
+ Output 9	Output 6	<input checked="" type="checkbox"/>
+ Output 10	Output 7	<input checked="" type="checkbox"/>
+ Output 11	Output 8	<input checked="" type="checkbox"/>
+ Output 12	Output 9	<input checked="" type="checkbox"/>
+ Output 13	Output 10	<input checked="" type="checkbox"/>
+ Output 14	Output 11	<input checked="" type="checkbox"/>
+ Output 15	Output 12	<input checked="" type="checkbox"/>
+ Output 16	Output 13	<input checked="" type="checkbox"/>
+ Output 17	Output 14	<input checked="" type="checkbox"/>
+ Output 18	Output 15	<input checked="" type="checkbox"/>
+ Output 19	Output 16	<input checked="" type="checkbox"/>
+ Output 20	Output 17	<input checked="" type="checkbox"/>
+ Information	Output 18	<input checked="" type="checkbox"/>
	Output 19	<input checked="" type="checkbox"/>
	Output 20	<input checked="" type="checkbox"/>
	Action if logic result = 0	OFF
	Action if logic result = 1	ON

3.6.1.1 Configuration of the Logic function

Parameter	Description	Value
Logic function type	The input objects are: OR linked. AND linked.	Or* And

For logic table see: [Appendix](#).

* Default value

Parameter	Description	Value
Number of logic inputs	This parameter determines the number of inputs of the logic block. Up to 4 inputs can be used.	1* 2 3 4

Communication objects:

Block 1 **405 - Logic block 1 ON/OFF - Input 2** (1 bit - 1.002 DPT_Bool)
406 - Logic block 1 ON/OFF - Input 3 (1 bit - 1.002 DPT_Bool)
407 - Logic block 1 ON/OFF - Input 4 (1 bit - 1.002 DPT_Bool)

Block 2 **411 - Logic block 2 ON/OFF - Input 2** (1 bit - 1.002 DPT_Bool)
412 - Logic block 2 ON/OFF - Input 3 (1 bit - 1.002 DPT_Bool)
413 - Logic block 2 ON/OFF - Input 4 (1 bit - 1.002 DPT_Bool)

Parameter	Description	Value
Inverting value of logic input x	The value of logic input x works on the logic block: With its object value (0=0, 1=1). With inverted object value (0=1, 1=0).	Maintain status* Status inversion

x = 1 to 4

Parameter	Description	Value
Value at initialization of logic input x	On initialization of the device after a download or after return of the bus power, the value of the logic input is: Set to 0. Set to 1. Set according to the value of the logic input before the initialization occurred.	0 1 Value before initialization*

x = 1 to 4

* Default value

3.6.1.2 Logic block authorization

Principle of logic block authorization:

The parameters are set as follows:

- Logic block authorization: 0 = Locked-up, 1 = Authorized.
- Action if logic result = 0 : Scene 1.
- Action if logic result = 1 : Scene 2.
- Logic input 1 and 2 are AND-linked.
- Emission of logic result: By input value change.

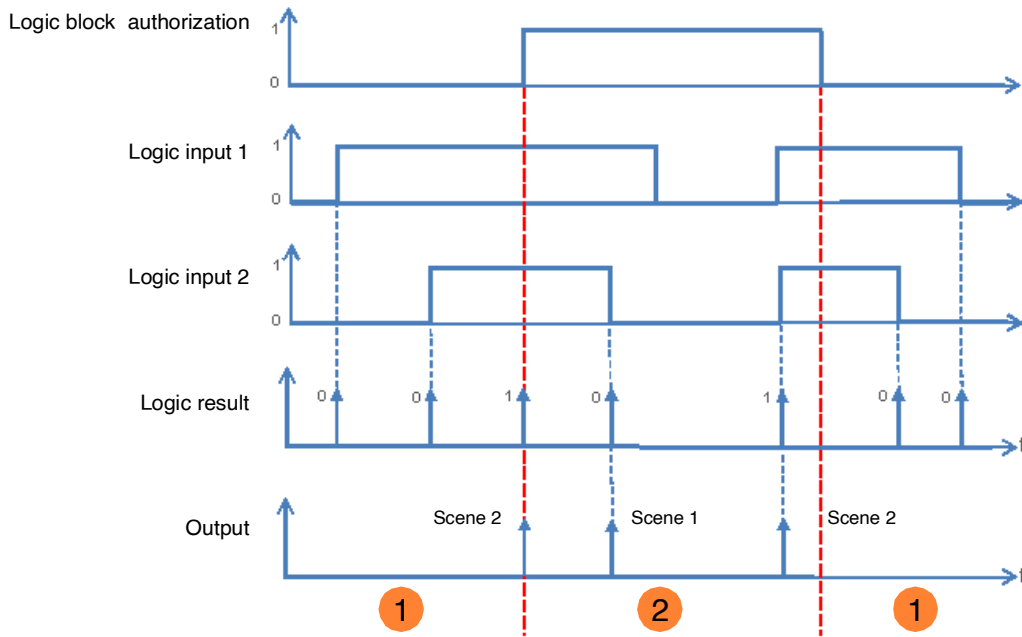

- ① The logic result has no influence on the outputCurrent values.
- ② The commands from the logic result are executed.

*Note: The commands from the logic result are executed immediately after authorization, according to the **Logic result after authorization** parameter.*

Parameter	Description	Value
Authorization object logic block	The Logic block 1 – Authorization communication object and related parameters are hidden.	Not active*
	The Logic block 1 – Authorization communication object and related parameters are displayed.	Active

Note: If the logic block is locked the logic operation is not processed.

- Communication objects:
- Block 1 **403 - Logic block 1 ON/OFF - Authorization** (1 bit - 1.003 DPT_Enable)
 - Block 2 **409 - Logic block 2 ON/OFF - Authorization** (1 bit - 1.003 DPT_Enable)

* Default value

Parameter	Description	Value
Value at initialization	On initialization of the device after a download or after return of the bus power, the value of the Logic block 1 – Authorization object is: Set to 0. Set to 1. Set according to the value that the object had before initialization.	0 1 Value before initialization*

Note: This parameter is only visible if the **Authorization object logic block** parameter has the following value: **Active**.

Parameter	Description	Value
Polarity	On receipt of a value on the Logic block 1 – Authorization object, this is: Locked-up on object value 1. Locked-up on object value 0.	0 = Authorized, 1 = Locked-up 0 = Locked-up, 1 = Authorized*

Note: This parameter is only visible if the **Authorization object logic block** parameter has the following value: **Active**.

Parameter	Description	Value
Logic result after autorisation	On authorization of the logic block: The value of the Logic result is immediately determined. The value of the logic result is first determined after receipt of a value on a logic input.	Immediate emission when authorization* No immediate emission

Note: This parameter is only visible if the **Authorization object logic block** parameter has the following value: **Active**.

3.6.1.3 Logic result

Parameter	Description	Value
Emission of logic result	The Logic result object will be sent on: Each receipt of a telegram on one of the logic inputs. A change in the value of the logic result.	By input value change By logic result value change*

Parameter	Description	Value
Logic result acts on outputs	The logic results acts: Only on the Logic result communication object. On the Logic result communication object and directly on one or more outputs.	Not active* Active

The status of the affected outputs is determined by the parameter **action on logic result = x**.

* Default value

Parameter	Description	Value
Output 1 ... x	The output relationship with the Logic result is: Directly dependent. Independent.	Yes* No

*Note: This parameter is only visible if the **Logic result acts on outputs** parameter has the following value: **Active**.*

Parameter	Description	Value
Action if logic result = 0	On the outputs that are directly dependent on Logic result, if the output value = 0, the status: Not changed. Is switched to the opposite status. Selectively switched on. Selectively switched off. Starts timer mode. Stops timer mode. Starts one of the 64 scenes. Adopts the default value given by the parameter Status if preset 1 object = 0 . Adopts the default value given by the parameter Status if preset 2 object = 0 .	Maintain status Inversion ON OFF* Timer start Timer stop Scene number Preset 1 Preset 2

Note: The Timer mode, Scene function or Preset function of the selected output must be configured. If this is not the case, the status remains unchanged.

Parameter	Description	Value
Scene if logic result = 0	This parameter determines the scene number that is activated if the logic result is 0 after re-evaluation.	Scene 1 ... 64 Default value: 1

The outputs respond according to the scene numbers and associated parameters.

*Note: This parameter is only visible if the **Action if logic result = 0** parameter has the following value: **Scene number**.*

* Default value

Parameter	Description	Value
Action if logic result = 1	<p>On the outputs that are directly dependent on Logic result, if the output value = 1, the status:</p> <p>Not changed.</p> <p>Is switched to the opposite status.</p> <p>Selectively switched on.</p> <p>Selectively switched off.</p> <p>Starts timer mode.</p> <p>Stops timer mode.</p> <p>Starts one of the 64 scenes.</p> <p>Adopts the default value given by the parameter Status if preset 1 object = 1.</p> <p>Adopts the default value given by the parameter Status if preset 2 object = 1.</p>	<p>Maintain status</p> <p>Inversion</p> <p>ON*</p> <p>OFF</p> <p>Timer start</p> <p>Timer stop</p> <p>Scene number</p> <p>Preset 1</p> <p>Preset 2</p>

Note: The Timer mode, Scene function or Preset function of the selected output must be configured. If this is not the case, the status remains unchanged.

Parameter	Description	Value
Scene if logic result = 1	This parameter determines the scene number that is activated if the logic result is 1 after re-evaluation.	<p>Scene 1 ... 64</p> <p>Default value: 2</p>

The outputs respond according to the scene numbers and associated parameters.

*Note: This parameter is only visible if the **Action if logic result = 1** parameter has the following value: **Scene number**.*

* Default value

3.6.2 Logic block : Shutter

The behaviour is determined by the following parameters:

Note: The description of the parameters is given for logic block 1. The parameters and objects are identical for logic block 2 ; Only the terms will be adjusted.

Outputs 1-20: Function	Logic function type	<input type="radio"/> And <input checked="" type="radio"/> Or
Outputs 1-20: General	Number of logic inputs	1
- O1-20: Status indications shutter	Inverting value of logic input 1	<input checked="" type="radio"/> Maintain status <input type="radio"/> Status inversion
- O1-20: Logic block 1 shutter	Value at initialization of logic input 1	Value before initialization
- O1-20: Logic block 2 shutter		
+ Outputs 1-2	Authorization object logic block	<input checked="" type="checkbox"/>
+ Output 3	Value at initialization	Value before initialization
+ Output 4	Polarity	<input checked="" type="radio"/> 0 = Locked-up , 1 = Authorized <input type="radio"/> 0 = Authorized, 1 = Locked-up
+ Output 5	Logic result after autorisation	<input checked="" type="radio"/> Immediate emission when authorization <input type="radio"/> No immediate emission
+ Output 6		
+ Output 7	Emission of logic result	<input type="radio"/> By input value change <input checked="" type="radio"/> By logic result value change
+ Output 8	Logic result acts on outputs	<input checked="" type="checkbox"/>
+ Output 9	Outputs 1-2	<input checked="" type="checkbox"/>
+ Output 10	Action if logic result = 0	Maintain status
+ Output 11	Action if logic result = 1	Maintain status

3.6.2.1 Configuration of the Logic function

Parameter	Description	Value
Logic function type	The input objects are: OR linked. AND linked.	Or* And

For logic table see: [Appendix](#).

* Default value

Parameter	Description	Value
Number of logic inputs	This parameter determines the number of inputs of the logic block. Up to 4 inputs can be used.	1* 2 3 4

Communication objects:

Block 1 **421 - Logic block 1 shutter - Input 2** (1 bit - 1.002 DPT_Bool)
 422 - Logic block 1 shutter - Input 3 (1 bit - 1.002 DPT_Bool)
 433 - Logic block 1 shutter - Input 4 (1 bit - 1.002 DPT_Bool)

Block 2 **427 - Logic block 2 shutter - Input 2** (1 bit - 1.002 DPT_Bool)
 428 - Logic block 2 shutter - Input 3 (1 bit - 1.002 DPT_Bool)
 429 - Logic block 2 shutter - Input 4 (1 bit - 1.002 DPT_Bool)

Parameter	Description	Value
Inverting value of logic input x	The value of logic input x works on the logic block: With its object value (0=0, 1=1). With inverted object value (0=1, 1=0).	Maintain status* Status inversion

x = 1 to 4

Parameter	Description	Value
Value at initialization of logic input x	On initialization of the device after a download or after return of the bus power, the value of the logic input is: Set to 0. Set to 1. Set according to the value of the logic input before the initialization occurred.	0 1 Value before initialization*

x = 1 to 4

* Default value

3.6.2.2 Logic block authorization

Principle of logic block authorization:

The parameters are set as follows:

- Logic block authorization: 0 = Locked-up, 1 = Authorized.
- Action if logic result = 0 : Scene 1.
- Action if logic result = 1 : Scene 2.
- Logic input 1 and 2 are AND-linked.
- Emission of logic result: By input value change.

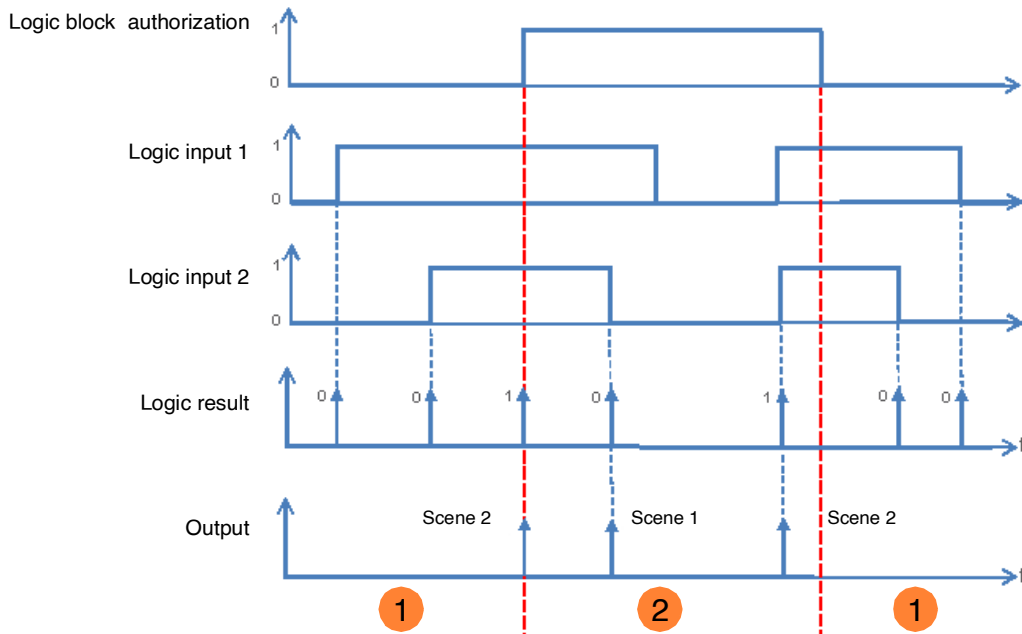

- ① The logic result has no influence on the outputCurrent values.
- ② The commands from the logic result are executed.

Note: The commands from the logic result are executed immediately after authorization, according to the **Logic result after authorization** parameter.

Parameter	Description	Value
Authorization object logic block	The Logic block 1 – Authorization communication object and related parameters are hidden.	Not active*
	The Logic block 1 – Authorization communication object and related parameters are displayed.	Active

Note: If the logic block is locked the logic operation is not processed.

- Communication objects:
- Block 1 **419 - Logic block 1 shutter - Authorization** (1 bit - 1.003 DPT_Enable)
 - Block 2 **425 - Logic block 2 shutter - Authorization** (1 bit - 1.003 DPT_Enable)

Parameter	Description	Value
Value at initialization	<p>On initialization of the device after a download or after return of the bus power, the value of the Logic block 1 – Authorization object is:</p> <p>Set to 0.</p> <p>Set to 1.</p> <p>Set according to the value that the object had before initialization.</p>	<p>0</p> <p>1</p> <p>Value before initialization*</p>

*Note: This parameter is only visible if the **Authorization object logic block** parameter has the following value: **Active**.*

Parameter	Description	Value
Polarity	<p>On receipt of a value on the Logic block 1 – Authorization object, this is:</p> <p>Locked-up on object value 1.</p> <p>Locked-up on object value 0.</p>	<p>0 = Authorized, 1 = Locked-up</p> <p>0 = Locked-up, 1 = Authorized*</p>

*Note: This parameter is only visible if the **Authorization object logic block** parameter has the following value: **Active**.*

Parameter	Description	Value
Logic result after autorisation	<p>On authorization of the logic block:</p> <p>The value of the Logic result is immediately determined.</p> <p>The value of the logic result is first determined after receipt of a value on a logic input.</p>	<p>Immediate emission when authorization*</p> <p>No immediate emission</p>

*Note: This parameter is only visible if the **Authorization object logic block** parameter has the following value: **Active**.*

3.6.2.3 Logic result

Parameter	Description	Value
Emission of logic result	The Logic result object will be sent on: Each receipt of a telegram on one of the logic inputs. A change in the value of the logic result.	By input value change By logic result value change*

Parameter	Description	Value
Logic result acts on outputs	The logic results acts: Only on the Logic result communication object. On the Logic result communication object and directly on one or more outputs.	Not active* Active

The status of the affected outputs is determined by the parameter **action on logic result = x**.

Parameter	Description	Value
Output 1 ... x	The output relationship with the Logic result is: Directly dependent. Independent.	Yes* No

*Note: This parameter is only visible if the **Logic result acts on outputs** parameter has the following value: **Active**.*

Parameter	Description	Value
Action if logic result = 0	Outputs that are directly dependent on Logic 1 result will, on output value 0: Not changed. Closes the Up contact. Closes the down contact. Opens the 2 contacts. Runs to a specific position. Runs to a position set in a scene. Run to the default position set in the Status if preset 1 object = 0 parameter Run to the default position set in the Status if preset 2 object = 0 parameter	Maintain status* Up Down Stop Specific position Scene number Preset 1 Preset 2

Note: The Scene function or Preset function of the selected output must be configured. If this is not the case, the status remains unchanged.

Parameter	Description	Value
Position (0-100%)	This parameter determines the position of the shutter or blind to be activated if the logic result is 0 after re-evaluation.	0 ... 5* ... 100

*Note: This parameter is only visible if the **Action if logic result = 0** parameter has the following value: **Specific position**.*

* Default value

Parameter	Description	Value
Slat angle (0-100%)	This parameter determines the slat position of the blind to be set if the logic result is 0 after re-evaluation.	0 ... 5* ... 100

Note: This parameter is only visible if the **Action if logic result = 0** parameter has the following value: **Specific position**.

Parameter	Description	Value
Scene if logic result = 0	This parameter determines the scene number that is activated if the logic result is 0 after re-evaluation.	Scene 1 ... 64 Default value: 1

The outputs respond according to the scene numbers and associated parameters.

Note: This parameter is only visible if the **Action if logic result = 0** parameter has the following value: **Scene number**.

Parameter	Description	Value
Action if logic result = 1	Outputs that are directly dependent on Logic 1 result will, on output value 1: Not changed. Closes the Up contact. Closes the down contact. Opens the 2 contacts. Runs to a specific position. Runs to a position set in a scene. Run to the default position set in the Status if preset 1 object = 0 parameter Run to the default position set in the Status if preset 2 object = 0 parameter	Maintain status* Up Down Stop Specific position Scene number Preset 1 Preset 2

Note: The Scene function or Preset function of the selected output must be configured. If this is not the case, the status remains unchanged.

Parameter	Description	Value
Position (0-100%)	This parameter determines the position of the shutter or blind to be activated if the logic result is 1 after re-evaluation.	0 ... 5* ... 100

Note: This parameter is only visible if the **Action if logic result = 1** parameter has the following value: **Specific position**.

Parameter	Description	Value
Slat angle (0-100%)	This parameter determines the slat position of the blind to be set if the logic result is 1 after re-evaluation.	0 ... 5* ... 100

Note: This parameter is only visible if the **Action if logic result = 1** parameter has the following value: **Specific position**.

* Default value

Parameter	Description	Value
Scene if logic result = 1	This parameter determines the scene number that is activated if the logic result is 1 after re-evaluation.	Scene 1 ... 64 Default value: 1

The outputs respond according to the scene numbers and associated parameters.

*Note: This parameter is only visible if the **Action if logic result = 1** parameter has the following value: **Scene number**.*

* Default value

3.7 Diagnosis

The **Device diagnosis** object allows notifications about the operating status of the device to be sent via the KNX bus. This information is sent periodically and/or on status change.

The **Device diagnosis** object allows reporting of current faults according to the device and application. It also allows sending of the position of the switch on the front of the device and the number of the output that is affected by the fault(s).

The **Device Diagnosis** object is a 6-byte object that is composed as described below:

Byte number	6 (MSB)	5	4	3	2	1 (LSB)
Use	Switch position	Application type	Output number	Error codes		

Details of the byte:

- **Bytes 1 to 4:** Correspond to the error codes.

MSB

LSB

b31	b30	b29	b28	b27	b26	b25	b24	b23	b22	b21	b20	b19	b18	b17	b16	b15	b14	b13	b12	b11	b10	b9	b8	b7	b6	b5	b4	b3	b2	b1	b0
32	X	X	X	28	27	X	X	X	X	X	X	X	X	X	X	X	X	X	X	X	X	X	9	X	X	X	X	X	X	X	X

N°	Faults
27	Wrong context: The user's parameters are not transferable. The standard parameters are restored.
28	TP communication out of operation: Communication via the KNX bus was not available on the previous start.
32	Minimum switching time not complied with: The device is equipped with a mechanism for limiting the number of switching cycles per minute of the output contact. If the user requires a number of switching cycles that is greater than this limit, this bit informs the user that his command was not carried out.
9	Excessive number of restarts: This bit is use for notification of repeated restarts and/or a restart triggered by a Watch-Dog. Such a restart is not necessarily apparent to the user from the function, rather it is manifest as a disturbed environment or a bad contact of the power supply.

Note: The use of the standard bit depends on the type of device used (switch actuator, dimmer, shutter/blind, etc.). Certain bit are same for all devices and others are application-specific.

- **Byte 5:** Corresponds to the application type and the number of the output affected by the error.

MSB

LSB

b7	b6	b5	b4	b3	b2	b1	b0
Application type				Output number			
0 = Not defined				0 = Device error			
1 = Switch actuator				1 = Output 1			
2 = Shutter/blind				2 = Output 2			
3 = Dimmer						
				Y = Output Y			

Note: Y is the placeholder for the maximum number of outputs.

* Default value

- **Byte 6:** Switch position.

MSB							LSB
b7	b6	b5	b4	b3	b2	b1	b0
X	X	X	X	X	X	X	1

1: 0 = Automatic mode / 1 = Manual mode

Note: Bit marked with an x are not used.

Outputs 1-20: Function	Emission	On status change and periodically
Outputs 1-20: General	Hours	0 h
- O1-20: Manual mode ON/OFF	Minutes	30 min
- O1-20: Status indications ON/OFF	Seconds	0 s
- O1-20: Status indications shutter		
- O1-20: Device diagnosis		

Parameter	Description	Value
Emission	The Device diagnosis communication object is sent to bus: On each change. Periodically after a configurable time. On change and periodically after a configurable time.	On status change* Periodically On status change and periodically

Parameter	Description	Value
Hours (h)	This parameter determines the time between the individual transmissions of the Device diagnosis object.	0 hours: 0 to 23 h
Minutes (min)		30 minutes: 0 to 59 min
Seconds (s)		0 seconds: 0 to 59 s

Note: The smallest executable time is 1 second.

*Note: This parameter is only visible if the **Emission** parameter has the following value: **Periodically** or **On status change and periodically**.*

* Default value

3.8 Functions of each switch actuator

This parameter window is used to set the device outputs. These parameters are available individually for each output.

3.8.1 Function selection

Outputs 1-20: Function	Output contact	<input checked="" type="radio"/> Normally open <input type="radio"/> Normally closed
Outputs 1-20: General	Manual mode active for output 3	<input checked="" type="checkbox"/>
- O1-20: Manual mode ON/OFF	Status indication ON/OFF	<input checked="" type="checkbox"/>
- O1-20: Status indications ON/OFF	ON/OFF timings function	<input type="checkbox"/>
- O1-20: Status indications shutter	Timer	<input type="checkbox"/>
+ Outputs 1-2	Scene	<input type="checkbox"/>
- Output 3	Preset	Not active
Output 3: Function selection	Lock-up	Not active
	Priority	<input type="checkbox"/>
	Hours counter	<input type="checkbox"/>

Parameter	Description	Value
Output contact	On receipt of an ON command: The output relay closes. The output relay opens.	Normally open* Normally closed

Principle:

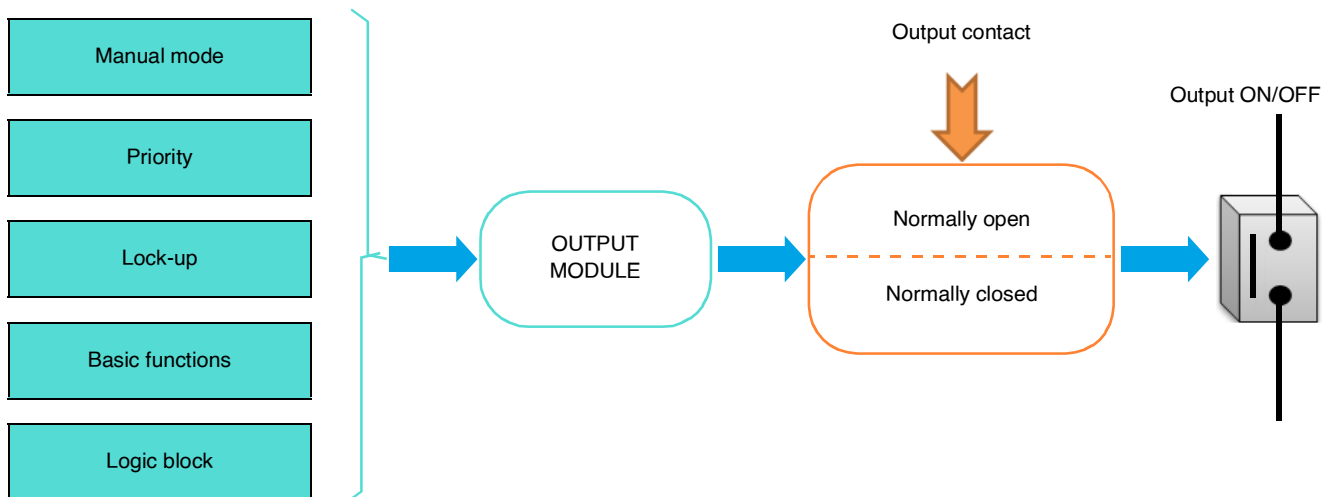

* Default value

Parameter	Description	Value
Manual mode active for output 1	This output can be controlled in manual mode.	Yes*
	This output is excluded from manual mode.	No

Parameter	Description	Value
Status indication ON/OFF	The Status indication ON/OFF communication object is: Hidden.	No
	Displayed, the status indication can be transmitted over the bus.	Yes*

Communication objects: [4, 24, ... 384 - Output x - Status indication ON/OFF \(1 bit - 1.001 DPT_Switch\)](#)

*Note: The transmission conditions for the Status indication objects must be set in the parameter Register **O1-Ox: Status indication**.*

Parameter	Description	Value
ON/OFF timings function	The ON/OFF timings function tab and the associated parameters and objects are: Hidden.	Not active*
	Displayed.	Active

For configuration see section: [ON/OFF timings function](#).

Parameter	Description	Value
Timer	The Timer tab and the associated parameters and objects are: Hidden.	Not active*
	Displayed.	Active

* Default value

Communication objects: [5, 25, ... 385 - Output x - Timer](#) (1 bit - 1.001 DPT_Start/stop)

For configuration see section: [Timer](#).

Parameter	Description	Value
Scene	The Scenes tab and the associated parameters and objects are: Hidden. Displayed.	Not active* Active

Communication objects: [7, 27, ... 387 - Output x - Scene](#) (1 byte - 18.001 DPT_SceneControl)

For configuration see section: [Scene ON/OFF](#).

Parameter	Description	Value
Preset	The Preset tab and the associated parameters and objects are: Hidden. Displayed for 1 Preset object. Displayed for 2 Preset objects.	Not active* Active with preset 1-level object Active with preset 2-level objects

Note: When the value of this parameter changes, the associated parameters and group addresses are deleted.

* Default value

Preset 1 communication Objects [8, 28, ... 388 - Output x - Preset 1](#) (1 bit - 1.022 DPT_Scene)

Preset 2 communication Objects [9, 29, ... 389 - Output x - Preset 2](#) (1 bit - 1.022 DPT_Scene)

For configuration see section: [Preset ON/OFF](#).

Parameter	Description	Value
Lock-up	The Lock-up tab and the associated parameters and objects are: Hidden. Displayed for 1 lock-up object. Displayed for 2 lock-up objects.	Not active* 1 lock-up object 2 lock-up objects

Lock-up 1 communication objects [12, 32, ... 392 - Output x - Lock-up 1](#) (1 bit - 1.003 DPT_Enable)

Lock-up 2 communication objects [13, 33, ... 393 - Output x - Lock-up 2 \(1 bit - 1.003 DPT_Enable\)](#)

For configuration see section: [Lock-up ON/OFF](#).

Parameter	Description	Value
Priority	The Priority tab and the associated parameters and objects are: Hidden. Displayed.	Not active* Active

The device responds to telegrams received via the **Priority** object, as given in the following table:

Telegram received by the priority operation object		Status of the outputs
Bit 1	Bit 2	
0	0	End of the priority
0	1	End of the priority
1	0	Priority OFF
1	1	Priority ON

Communication objects: [15, 35, ... 395 - Output x - Priority \(2 bit - 2.002 DPT_Bool_Control\)](#)

For configuration see section: [Priority ON/OFF](#).

* Default value

Parameter	Description	Value
Hours counter	The Hours counter tab and the associated parameters and objects are: Hidden. Displayed.	Not active* Active

A telegram can be transmitted via the **Hours counter setpoint reached** object, in accordance with a programmable setpoint. It is also possible to reset the count value via a 1 signal on the **Reset hours counter value** object.

Communication objects:

[17, 37, ... 397 - Output x - Hours counter value \(h\)](#) (2 bytes - 7.007 DPT_Time(h))

[18, 38, ... 398 - Output x - Reset hours counter value](#) (1 bit - 1.015 DPT_Reset)

[19, 39, ... 399 - Output x - Hours counter setpoint reached](#) (1 bit - 1.011 DPT_State)

For configuration see section: [Hours counter](#).

* Default value

3.8.2 ON/OFF timings function

Outputs 1-20: Function	Delays for ON/OFF objects	Switching and tripping delay
Outputs 1-20: General	Switching delay	0 h
- O1-20: Manual mode ON/OFF	Switching delay	3 min
- O1-20: Status indications ON/OFF	Switching delay, minimum value 1s	0 s
- O1-20: Status indications shutter	Tripping delay	0 h
+ Outputs 1-2	Tripping delay	3 min
- Output 3	Tripping delay, minimum value 1s	0 s
Output 3: Function selection	Timer/toggle switch changeover for object ON/OFF	<input checked="" type="checkbox"/>
- O3: ON/OFF object timings	Hours	1 h
+ Output 4	Minutes	0 min
+ Output 5	Second, minimum value 1s	0 s
+ Output 6	Additional time limited toggle switch function	<input checked="" type="checkbox"/>
+ Output 7	Hours	1 h
+ Output 8	Minutes	0 min
+ Output 9	Second, minimum value 1s	0 s

3.8.2.1 Delays for ON/OFF objects

Parameter	Description	Value
Delays for ON/OFF objects	The parameters for time-delayed switching of the outputs are: Hidden. Displayed for Switching delay. Displayed for Tripping delay. Displayed for Switching and tripping delay.	Not active* Switching delay Tripping delay Switching and tripping delay

Switching delay: Allows the configuration of a delay between the switch-on command and the switching of the output contact.

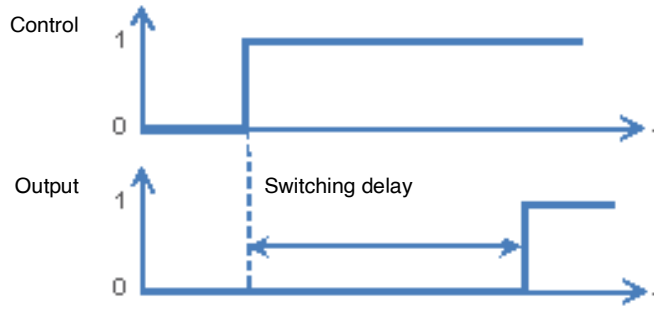

Tripping delay: Allows the configuration of a delay between the switch-off command and the switching of the output contact.

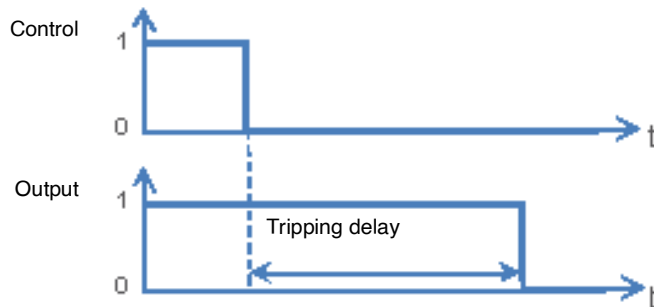

Switching and tripping delay: Allows the configuration of a delay between the switch-on command and the switching of the output contact, as well as between the switch-off command and the switching of the output contact.

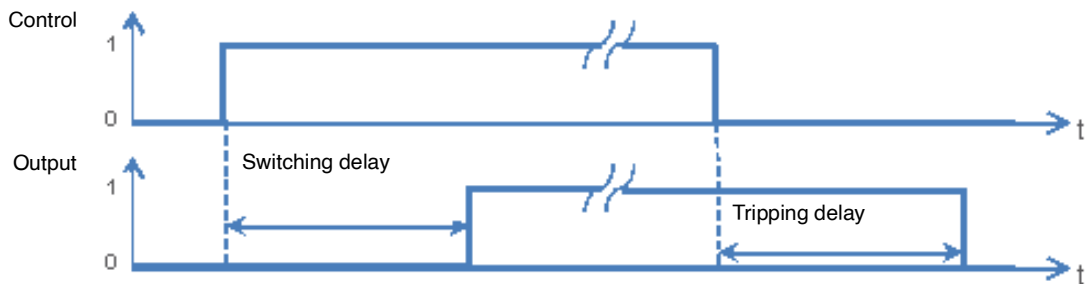

Parameter	Description	Value
Switching delay	This parameter defines the delay between the switch-on command and the switching of the output contact.	0 hours: 0 to 23 h 3 minutes: 0 to 59 min 0 seconds: 0 to 59 s

Note: The smallest executable time is 1 second.

*Note: This parameter is only visible if the **Delays for ON/OFF** objects parameter has the following value: **Switching delay** or **Switching and tripping delay**.*

Parameter	Description	Value
Tripping delay	This parameter defines the delay between the switch-off command and the switching of the output contact.	0 hours: 0 to 23 h 3 minutes: 0 to 59 min 0 seconds: 0 to 59 s

Note: The smallest executable time is 1 second.

*Note: This parameter is only visible if the **Delays for ON/OFF** objects parameter has the following value: **Tripping delay** or **Switching and tripping delay**.*

* Default value

3.8.2.2 Timer/toggle switch changeover for ON/OFF object

This function switches the output channels between toggle switch and timer mode for the **ON/OFF** object.

Example: Switching function daytime and Time-limited OFF function at night.

During the day, the button is used as a switch. In the evenings, the button is used as a time-limited OFF switch, so that the light will turn off automatically.

Parameter	Description	Value
Timer/toggle switch changeover for ON/OFF object	The parameters for a switch-over between toggle switch and timer modes for the ON/OFF object are: Hidden. Displayed.	Not active* Active

- If the **Timer/toggle switch changeover** object receives the value 1, the Toggle-switch mode function is activated. The ON/OFF switching of the output is performed as usual via the **ON/OFF** object.
- If the **Timer/toggle switch changeover** object receives the value 0, the Timer mode function is activated.
 - If the **ON/OFF** object receives the value 1, the output is switched ON. After expiry of a configurable time, the output is automatically switched OFF.
 - If the **ON/OFF** object receives the value 0, the output is switched OFF.

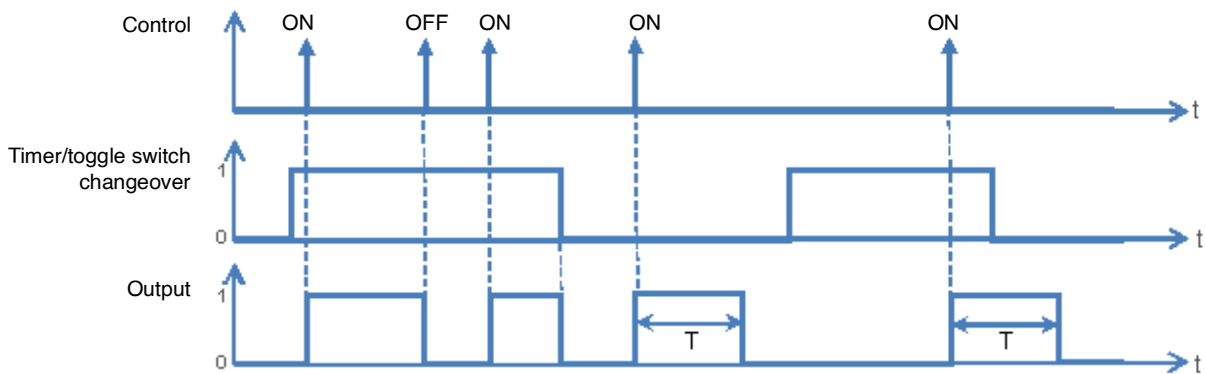

Communication objects: [2, 22, ... 382 - Output x - Timer/toggle switch changeover \(1 bit - 1.001 DPT_Switch\)](#)

* Default value

Parameter	Description	Value
Hours (h)	This parameter sets the length of the timer operation, if this is activated.	1 hours: 0 to 23 h
Minutes (min)		0 minutes: 0 to 59 min
Seconds (s)		0 seconds: 0 to 59 s

Note: The smallest executable time is 1 second.

Note: This parameter is only visible if the **Timer/toggle switch changeover parameter for the ON/OFF object** has the following value: **Active**.

3.8.2.3 Time limited toggle switch

The Time-limited OFF function enables automatic switch off after a programmable Time-limited OFF time. The output works as a normal switch actuator but is switched off after a given time for security.

Example: Attic, the lighting can be switched normally but switches off after not more than 3 hours.

Parameter	Description	Value
Additional time limited toggle switch function	The parameters for setting the Time-limited OFF time are: Hidden. Displayed.	Not active* Active

Function diagram

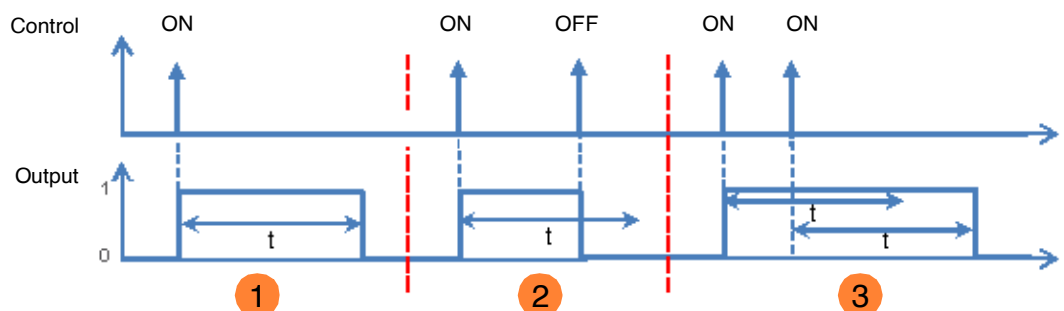

- 1** Emission of an ON command: The output which is at ON will switch to OFF on expiry of the Time-limited OFF time.
- 2** Emission of an ON command: The output switches to ON.
Emission of an OFF command before expiry of the Time-limited OFF time, t: The output switches to OFF.
- 3** Emission of an ON command: The output switches to ON.
Emission of an ON command before expiry of the Time-limited OFF time, t: The output remains at ON and the Time-limited OFF time, t, is re-started.

* Default value

Communication objects: [3, 23, ... 383 - Output x - Time limited toggle switch object \(1 bit - 1.001 DPT_Switch\)](#)

Parameter	Description	Value
Hours (h)	This parameter sets the length of the timer operation for the Time-limited toggle switch, if this is activated.	1 hours: 0 to 23 h
Minutes (min)		0 minutes: 0 to 59 min
Seconds (s)		0 seconds: 0 to 59 s

Note: The smallest executable time is 1 second.

*Note: This parameter is only visible if the **Additional time limited toggle switch function** parameter has the following value: **Active**.*

3.8.3 Timer

The Timer function can switch a lighting circuit on or off for a configurable period. According to the selected operating mode of the timer, the output can be turned ON or OFF for a determined period of time. The timer may be interrupted before expiry of the delay time. A programmable Cut-OFF pre-warning announces the end of the delay time by a 1-second inversion of the output status.

Outputs 1-20: Function	Timer operation	ON
Outputs 1-20: General	Timer duration	0 h
- O1-20: Manual mode ON/OFF	Timer duration	3 min
- O1-20: Status indications ON/OFF	Timer duration, minimum value 1s	0 s
- O1-20: Status indications shutter	Cut-OFF pre-warning	<input checked="" type="checkbox"/>
+ Outputs 1-2	Hours	0 h
- Output 3	Minutes	0 min
Output 3: Function selection	Seconds	30 s
- O1: Timer	Timer interruption	<input checked="" type="checkbox"/>
+ Output 4	Timer retriggerability	<input checked="" type="checkbox"/>
+ Output 5	Timer duration extension (10 first seconds)	Unlimited
+ Output 6	Timer duration modifiable through object	<input type="checkbox"/>

* Default value

3.8.3.1 Timer operation

Parameter	Description	Value
Timer operation	When the timer is active, the output for the Timer duration is: Selectively switched on. Selectively switched off. Switched alternately ON and OFF. (Blink time is configurable via additional parameters.)	ON* OFF Blinking

Parameter	Description	Value
Hours (h)	This parameter determines the timer duration.	0 hours: 0 to 23 h
Minutes (min)		2 minutes: 0 to 59 min
Seconds (s)		0 seconds: 0 to 59 s

Note: The smallest executable time is 1 second.

Parameter	Description	Value
Blinking ON duration (s)	This parameter determines the closing duration of the output contact when blinking.	5 seconds: 5 to 240 s

*Note: This parameter is only visible if the **Timer operation** parameter has the following value: **Blinking**.*

Parameter	Description	Value
Blinking OFF duration (s)	This parameter determines the opening duration of the output contact when blinking.	5 seconds: 5 to 240 s

*Note: This parameter is only visible if the **Timer operation** parameter has the following value: **Blinking**.*

Parameter	Description	Value
Output status during blinking function	When the switch actuator is blinking, the Status indication ON/OFF object sends: The value, 1 = ON. The value, 0 = OFF. The values 1 and 0 alternately. (The status object blinks accordingly.)	ON* OFF ON/OFF

*Note: This parameter is only visible if the **Timer operation** parameter has the following value: **Blinking**.*

* Default value

3.8.3.2 Cut-OFF pre-warning

Parameter	Description	Value
Cut-OFF pre-warning	Before expiry of the timer delay there is: No warning. A warning through a 1-second inversion of the output status. The lead time of this warning can be set.	Not active Active*

Parameter	Description	Value
Hours (h)	This parameter determines the lead time of the cut-OFF pre-warning.	0 hours: 0 to 23 h
Minutes (min)		0 minutes: 0 to 59 min
Seconds (s)		30 seconds: 0 to 59 s

Note: The smallest executable time is 1 second.

*Note: This parameter is only visible if the **Cut-OFF pre-warning** parameter has the following value: **Active**.*

Note: If the lead time of the cut-OFF pre-warning is greater than the duration of the timer, the cut-OFF pre-warning is not triggered.

3.8.3.3 Configuration

Parameter	Description	Value
Timer interruption	On receiving the value 0 on the Timer communication object, the timing is: Interrupted. Not interrupted.	Yes* No

Parameter	Description	Value
Timer retriggerability	The parameter Timer duration extension (10 first seconds) is: Hidden. Displayed.	No Yes*

* Default value

Parameter	Description	Value
Timer duration extension (10 first seconds)	<p>If, during the first 10 seconds of the timer duration, multiple commands with the value 1 are received on the Timer communication object, it is:</p> <p>Multiplied unlimited times.</p> <p>Multiplied a maximum of 1x.</p> <p>Multiplied a maximum of 2x.</p> <p>Multiplied a maximum of 3x.</p> <p>Multiplied a maximum of 4x.</p> <p>Multiplied a maximum of 5x.</p>	<p>Unlimited*</p> <p>1-time duration extension</p> <p>2-time duration extension</p> <p>3-time duration extension</p> <p>4-time duration extension</p> <p>5-time duration extension</p>

Parameter	Description	Value
Timer duration modifiable through object	<p>The Timer duration communication object is:</p> <p>Hidden.</p> <p>Displayed, the timer duration can be transmitted via the bus.</p>	<p>Not active*</p> <p>Active</p>

Communication objects: [6, 26, ... 386 - Output x - Timer duration \(3 bytes - 10.001 DPT_TimeOfDay\)](#)

3.8.4 Scene

Outputs 1-20: Function	Number of scenes used	8
Outputs 1-20: General	Scenes memorisation by long key press	<input checked="" type="checkbox"/>
- O1-20: Manual mode ON/OFF	Scenes memorisation acknowledgment (Output status inverted for 3s)	<input type="checkbox"/>
- O1-20: Status indications ON/OFF	Output status for scene 1	Not active
- O1-20: Status indications shutter	Output status for scene 2	Not active
+ Outputs 1-2	Output status for scene 3	Not active
- Output 3	Output status for scene 4	Not active
Output 3: Function selection	Output status for scene 5	Not active
- O3: Scenes	Output status for scene 6	Not active
+ Output 4	Output status for scene 7	Not active
+ Output 5	Output status for scene 8	Not active
+ Output 6	Blinking ON duration	5 s
+ Output 7	Blinking OFF duration	5 s
+ Output 8	Output status during blinking function	ON

Parameter	Description	Value
Number of scenes used	This parameter determines the number of scenes used.	8* - 16 - 24 - 32 - 48 - 64

Note: If the Scene number received on the Scene object is greater than the maximum number of scenes, the status of the output remains unchanged.

Parameter	Description	Value
Scenes memorisation by very long key press	This parameter allows learning and storing of a scene by, for example, a long press (> 5 seconds) of the corresponding push button.	Not active Active*

Learning and storing scenes

This process is used to change and store a scene. For example, by locally pressing the key in the room or by emission of the values from a visualization.

* Default value

To access and store scenes, the following values must be sent:

Scene number	Access scene (Object value: 1 byte)	Store scene (Object value: 1 byte)
1 - 64	= Scene number - 1	= Scene number + 128
Example		
1	0	128
2	1	129
3	2	130
...	...	
64	63	191

Here is the scene memorisation for local switches, for example.

- Activate scene by briefly pressing the transmitter that starts it.
- The outputs (lights, shutters, etc.) are set in the desired state using the usual local control devices (buttons, remote control, etc.).
- Memorise the status of the outputs with a press greater than 5 seconds long on the transmitter that starts the scene. The memorisation can be displayed by short-term activation of the outputs.

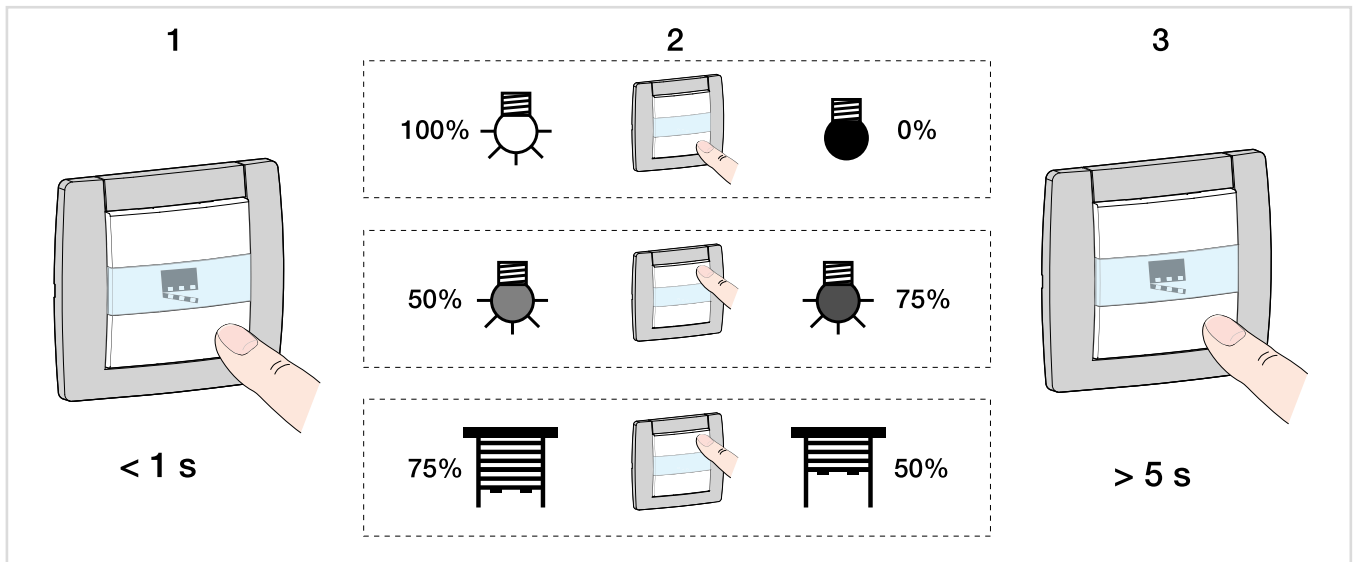

Parameter	Description	Value
Scenes memorisation acknowledgment	Memorisation of a scene is: Not acknowledged. Acknowledged by the output by a 3 second long inversion of the output status.	Not active* Active

* Default value

Parameter	Description	Value
Output status for scene X	On activation of Scene X, the output is: Not changed. Selectively switched on. Selectively switched off. Switched alternately ON and OFF. (Blink time is configurable via additional parameters.)	Not active* ON OFF Blinking

X = 1 to 64

*Note: Each output has up to 64 scenes available, in accordance with the **Number of scenes used** parameter.*

*Note: Local storage of the scene is not recorded if the **Output status for scene X** parameter is not active or is blinking.*

Parameter	Description	Value
Blinking ON duration (s)	This parameter determines the closing duration of the output contact when blinking.	5 seconds : 5 to 240 s

*Note: This parameter applies to all scenes involving the respective output, which has the following value: **Blinking**.*

Parameter	Description	Value
Blinking OFF duration (s)	This parameter determines the opening duration of the output contact when blinking.	5 seconds : 5 to 240 s

*Note: This parameter applies to all scenes involving the respective output, which has the following value: **Blinking**.*

Parameter	Description	Value
Output status during blinking function	When the switch actuator is blinking, the Status indication ON/OFF object sends: The value, 1 = ON. The value, 1 = OFF. The values 1 and 0 alternately. (The status object blinks accordingly.)	ON* OFF ON/OFF

*Note: This parameter applies to all scenes involving the respective output, which has the following value: **Blinking**.*

* Default value

3.8.5 Preset

Outputs 1-20: Function	Preset authorization objects	<input checked="" type="checkbox"/>
Outputs 1-20: General	Value of authorization preset 1 at initialization	Value before initialization
- O1-20: Manual mode ON/OFF	Value of authorization preset 2 at initialization	Value before initialization
- O1-20: Status indications ON/OFF	Polarity of Preset 1 authorization object	<input checked="" type="radio"/> 0 = Locked-up , 1 = Authorized <input type="radio"/> 0 = Authorized, 1 = Locked-up
- O1-20: Status indications shutter	Polarity of Preset 2 authorization object	<input checked="" type="radio"/> 0 = Locked-up , 1 = Authorized <input type="radio"/> 0 = Authorized, 1 = Locked-up
+ Outputs 1-2		
- Output 3	Status if preset 1 object = 0	Scene number
Output 3: Function selection	Scene for preset 1 = 0	1
- O3: Preset	Status if preset 1 object = 1	Blinking
+ Output 4	Blinking ON duration	5 s
+ Output 5	Blinking OFF duration	5 s
+ Output 6	Output status during blinking function	ON
+ Output 7	Status if preset 2 object = 0	Maintain status
	Status if preset 2 object = 1	Maintain status

The Preset function is used to switch an output into various predefined states. The Preset function is activated via an object in 1-bit format.

Principle of Preset authorization:

The parameters are set as follows:

- Polarity of Preset 1 authorization object: 0 = Locked-up, 1 = Authorized.
- Polarity of Preset 2 authorization object: 0 = Locked-up, 1 = Authorized.
- Status if preset 1 object = 0: ON.
- Status if preset 1 object = 1: OFF.
- Status if preset 2 object = 0: Scene 1.
- Status if preset 2 object = 1: Scene 2.

* Default value

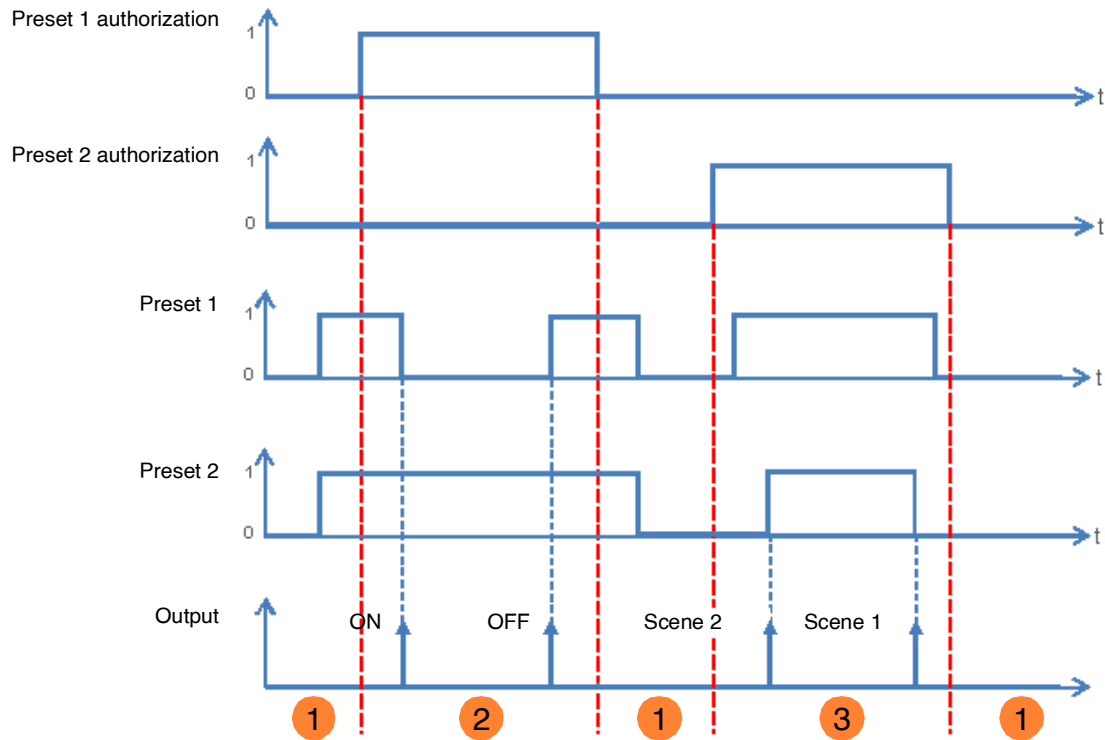

- ❶ The preset inputs have no influence on the output.
- ❷ The commands from Preset 1 are executed.
- ❸ The commands from Preset 2 are executed.

Note: The commands from the Preset will not be executed immediately after authorization, but only when the value of the Preset changes.

Parameter	Description	Value
Preset authorization objects	The Preset 1 authorization communication object and the related parameters are: Hidden. Displayed. This object allows the authorization or lock-up of the Preset 1 function via a KNX telegram.	Not active* Active

Note: The number of available Preset objects is dependent on the **Preset** parameter. A maximum of two of these objects can be available.

* Default value

Communication objects: [10, 30, ... 390 - Output x - Preset 1 authorization](#) (1 bit - 1.003 DPT_Enable)

Communication objects: [11, 31, ... 391 - Output x - Preset 2 authorization](#) (1 bit - 1.003 DPT_Enable)

Note: The parameters and objects are identical for Preset 2 ; Only the terms will be adjusted.

Parameter	Description	Value
Value of authorization preset 1 at initialization	On initialization of the device after a download or after return of the bus power, the value of the Preset 1 authorization object is: Set to 0. Set to 1. Set according to the value of the logic input before the initialization occurred.	0 1 Value before initialization*

*Note: This parameter is only visible if the **Preset authorization objects** parameter has the following value: **Active**.*

Parameter	Description	Value
Polarity of Preset 1 authorization object	On receipt of a value on the Preset 1 authorization object, Preset 1 : Locked-up on object value 1. Locked-up on object value 0.	0 = Locked-up, 1 = Authorized* 0 = Authorized, 1 = Locked-up

*Note: This parameter is only visible if the **Preset authorization objects** parameter has the following value: **Active**.*

Parameter	Description	Value
Status if preset 1 object = 0	On receipt of the value 0 on the Preset 1 object, the output is: Not changed. Is switched to the opposite status. Selectively switched on. Selectively switched off. Set to a scene value. Set in blinking mode. Switched to the status that was active before last receiving the value 1 on the Preset 1 object.	Maintain status* Inversion ON OFF Scene number Blinking Status before preset 1 = 1

Parameter	Description	Value
Scene for preset 1 = 0	This parameter determines the value of the scene if: The Preset 1 object has value 0. The Status if preset 1 object = 0 object has the scene value.	Scene 1 ... 64 Default value: 1

* Default value

Parameter	Description	Value
Status if preset 1 object = 1	<p>On receipt of the value 1 on the Preset 1 object, the output is:</p> <p>Not changed.</p> <p>Is switched to the opposite status.</p> <p>Selectively switched on.</p> <p>Selectively switched off.</p> <p>Set to a scene value.</p> <p>Set in blinking mode.</p> <p>Switched to the status that was active before last receiving the value 1 on the Preset 1 object.</p>	<p>Maintain status*</p> <p>Inversion</p> <p>ON</p> <p>OFF</p> <p>Scene number</p> <p>Blinking</p> <p>Status before preset 1 = 0</p>

Parameter	Description	Value
Scene for preset 1 = 1	<p>This parameter determines the value of the scene if:</p> <p>The Preset 1 object has value 1.</p> <p>The Status if preset 1 object = 1 object has the scene value.</p>	<p>Scene 1 ... 64</p> <p>Default value: Scene 2</p>

Parameter	Description	Value
Blinking ON duration (s)	This parameter determines the closing duration of the output contact when blinking.	5 seconds: 5 to 240 s

*Note: This parameter is only visible if the **Status if preset 1 object = 0** parameter or the **Status if preset 1 object = 1** parameter has the following value: **Blinking**.*

* Default value

Parameter	Description	Value
Blinking OFF duration (s)	This parameter determines the opening duration of the output contact when blinking.	5 seconds: 5 to 240 s

*Note: This parameter is only visible if the **Status if preset 1 object = 0** parameter or the **Status if preset 1 object = 1** parameter has the following value: **Blinking**.*

Parameter	Description	Value
Output status during blinking function	When the switch actuator is blinking, the Status indication ON/OFF object sends: The value, 1 = ON. The value, 0 = OFF. The values 1 and 0 alternately. (The status object blinks accordingly.)	ON* OFF ON/OFF

*Note: This parameter is only visible if the **Status if preset 1 object = 0** parameter or the **Status if preset 1 object = 1** parameter has the following value: **Blinking**.*

* Default value

3.8.6 Lock-up

Outputs 1-20: Function	Lock-up type	<input checked="" type="radio"/> Output lock-up <input type="radio"/> Object lock-up
Outputs 1-20: General	Lock-up duration	<input type="radio"/> Time limited <input checked="" type="radio"/> Permanently
- O1-20: Manual mode ON/OFF	Priority between lock-up 1 and lock-up 2	Lock-up 1 > Lock-up 2
- O1-20: Status indications ON/OFF	Activation of lock-up status object	<input checked="" type="checkbox"/>
- O1-20: Status indications shutter	Polarity	<input checked="" type="radio"/> 0 = Lock-up deactivated, 1 = Lock-up activated <input type="radio"/> 0 = Lock-up activated, 1 = Lock-up deactivated
+ Outputs 1-2	Emission	On status change and periodically
- Output 3	Hours	0 h
Output 3: Function selection	Minutes	10 min
- O3: Lock-up	Seconds	0 s
+ Output 4	Polarity of lock-up object 1	<input checked="" type="radio"/> 0 = Lock-up deactivated, 1 = Lock-up activated <input type="radio"/> 0 = Lock-up activated, 1 = Lock-up deactivated
+ Output 5	Status if lock-up 1	Maintain status
+ Output 6	Status after lock-up function 1	Maintain status
+ Output 7	Polarity of lock-up object 2	<input checked="" type="radio"/> 0 = Lock-up deactivated, 1 = Lock-up activated <input type="radio"/> 0 = Lock-up activated, 1 = Lock-up deactivated
+ Output 8	Status if lock-up 2	Maintain status
+ Output 9	Status after lock-up function 2	Maintain status

The Lock-up function is used to lock the output in a predefined state.
 Priority: Manual mode > Priority > **Lock-up** > Basic function.
 The Lock-up prevents actuation until an unlock command has been received.
 The Lock-up duration can be set.

Parameter	Description	Value
Lock-up type	<p>The Lock-up acts:</p> <p>Directly on the switch actuator. As long as the Lock-up is active, the output can only be controlled by higher priority commands.</p> <p>On selected communication objects. As long as the Lock-up is active, the output can only be controlled via specific selectable objects.</p>	<p>Output lock-up*</p> <p>Object lock-up</p>

* Default value

Parameter	Description	Value
Lock-up duration	The duration of the Lock-up is Not time limited, the lock-up is only authorized by means of a telegram on Lock-up 1 object. Is active for a limited time, the control of the output is authorized after expiry of this time.	Permanently* Time limited

Parameter	Description	Value
Hours (h)	This parameter determines the activation time of the Lock-up.	0 hours: 0 to 23 h
Minutes (min)		15 minutes: 0 to 59 min
Seconds (s)		0 seconds: 0 to 59 s

Note: The smallest executable time is 1 second.

Note: This parameter is only visible if the **Lock-up duration** parameter has the following value: **Time limited**.

Parameter	Description	Value
Polarity of lock-up object 1	On receipt of a value on the Lock-up 1 object, the lock-up: Locked-up on object value 1. Is deactivated on object value 0. Locked-up on object value 0. Is deactivated on object value 1.	0 = Lock-up deactivated, 1 = Lock-up activated* 0 = Lock-up activated, 1 = Lock-up deactivated

Note: The parameters and objects are identical for Lock-up 2 ; Only the terms will be adjusted.

Parameter	Description	Value
Priority between lock-up 1 and lock-up 2	The priority between lock-up 1 and lock-up 2 is set as follows: Lock-up 1 has priority over lock-up 2. Lock-up 2 has priority over lock-up 1. Lock-up 1 and lock-up 2 have the same priority.	Lock-up 1 > Lock-up 2* Lock-up 1 < Lock-up 2 Lock-up 1 = Lock-up 2

Note: This parameter is only visible if the **Lock-up** parameter has the following value: **Active with 2 lock-up objects**.

Note: The priority of the Lock-up always functions in the same way, independently of the lock-up type (Output lock-up or object lock-up).

* Default value

Operating principle of the priorities:

If Lock-up 1 > Lock-up 2

Active lock-up	Activation order of Lock-up 1	Activation order of Lock-up 2
None	Lock-up 1 is activated	Lock-up 2 is activated
Lock-up 1	Lock-up 1 remains active	Despite the activation order of Lock-up 2, Lock-up 1 remains activated
Lock-up 2	Lock-up 1 is activated	Lock-up 2 remains active

If Lock-up 1 = Lock-up 2

Active lock-up	Activation order of Lock-up 1	Activation order of Lock-up 2
None	Lock-up 1 is activated	Lock-up 2 is activated
Lock-up 1	Lock-up 1 remains active	Lock-up 2 is activated
Lock-up 2	Lock-up 1 is activated	Lock-up 2 remains active

If Lock-up 1 < Lock-up 2

Active lock-up	Activation order of Lock-up 1	Activation order of Lock-up 2
None	Lock-up 1 is activated	Lock-up 2 is activated
Lock-up 1	Lock-up 1 remains active	Lock-up 2 is activated
Lock-up 2	Despite the activation order of Lock-up 1, Lock-up 2 remains activated	Lock-up 2 remains active

Parameter	Description	Value
Status if lock-up 1	If the Lock-up type is set to Output lock-up , on activation of the lock-up the output will: Not changed. Switch to the opposite status. Selectively switched on. Selectively switched off.	Maintain status* Inversion ON OFF

Note: The parameters and objects are identical for Lock-up 2 ; Only the terms will be adjusted.

Lock-up 1 authorizes object:

The parameters listed below allow the selection of the objects for controlling the output via the nevertheless active Lock-up.

*Note: These parameters are only visible if the **Lock-up type** parameter has the following value: **Object lock-up**.*

* Default value

Parameter	Objects concerned	Value
ON/OFF	ON/OFF	Yes No*
Scene	Scene	Yes No*
Timer	Timer	Yes No*
Timer/toggle switch changeover	Timer/toggle switch changeover	Yes No*
Time limited toggle switch	Time limited toggle switch object	Yes No*
Preset 1	Preset 1	Yes No*
Preset 2	Preset 2	Yes No*

Note: The parameters and objects are identical for Lock-up 2 ; Only the terms will be adjusted.

Parameter	Description	Value
Status after lock-up function 1	<p>If the Lock-up type is set to Output lock-up, on cancellation of the lock-up the output will:</p> <p>Not changed.</p> <p>Switch to the opposite status.</p> <p>Selectively switched on.</p> <p>Selectively switched off.</p> <p>Return to the status that was active before the lock-up.</p>	<p>Maintain status*</p> <p>Inversion</p> <p>ON</p> <p>OFF</p> <p>Status before lock-up 1</p>

Note: The application of this parameter depends on the priority of the other active functions. If a function with higher priority is active, this parameter will not be enacted. In the case where two functions with the same priority are active, the parameter of the most recently switched off function is enacted.

Note: The parameters and objects are identical for Lock-up 2 ; Only the terms will be adjusted.

Parameter	Description	Value
Activation of lock-up status object	<p>The Status indication lock-up communication object is hidden.</p> <p>The Status indication lock-up communication object is displayed.</p>	<p>Not active*</p> <p>Active</p>

* Default value

Communication objects: [14, 34, ... 394 - Output x - Status indication lock-up \(1 bit - 1.011 DPT_State\)](#)

Parameter	Description	Value
Polarity	The Status indication Lock-up communication object sends: 0 on deactivation of the lock-up. 1 on activation of the lock-up. 0 on activation of the lock-up. 1 on deactivation of the lock-up.	0 = Lock-up deactivated, 1 = Lock-up activated* 0 = Lock-up activated, 1 = Lock-up deactivated

Parameter	Description	Value
Emission	The Status indication lock-up communication object is sent: On activation and deactivation of the lock-up. Periodically after a configurable time. On activation and deactivation of the lock-up and periodically after a configurable time.	On status change* Periodically On status change and periodically

*Note: This parameter is only visible if the **Activation of Lock-up status object** parameter has the following value: **Active**.*

Parameter	Description	Value
Hours (h)	This parameter determines the time between the individual transmissions of the Status indication lock-up object.	0 hours: 0 to 23 h
Minutes (min)		10 minutes: 0 to 59 min
Seconds (s)		0 seconds: 0 to 59 s

Note: The smallest executable time is 1 second.

*Note: This parameter is only visible if the **Emission** parameter has the following value: **Periodically** or **On status change and periodically**.*

* Default value

3.8.7 Priority

Outputs 1-20: Function	Activation of priority status object	<input checked="" type="checkbox"/>
Outputs 1-20: General	Polarity	<input checked="" type="radio"/> 0 = Not forced, 1 = Forced <input type="radio"/> 0 = Forced, 1 = Not forced
- O1-20: Manual mode ON/OFF	Emission	On status change and periodically
- O1-20: Status indications ON/OFF	Hours	0 h
- O1-20: Status indications shutter	Minutes	10 min
+ Outputs 1-2	Seconds	0 s
- Output 3	Status after priority	Maintain status
Output 3: Function selection		
- O3: Priority		

The Priority is used to force the output into a predefined state.

Priority: Manual mode > **Priority** > Lock-up > Basic function.

No other command is taken into account when the Priority is active. Only by ending the Priority are other commands again permitted.

Parameter	Description	Value
Activation of priority status object	The Status indication priority communication object and related parameters are hidden. The Status indication priority communication object and related parameters are displayed.	Not active* Active

Communication objects: [16, 36, ... 396 - Output x - Status indication priority \(1 bit - 1.011 DPT_State\)](#)

Parameter	Description	Value
Polarity	The Status indication priority communication object sends: 0 on deactivation of the Priority. 1 on activation of the Priority. 0 on activation of the Priority. 1 on deactivation of the Priority.	0 = Not forced, 1 = Forced* 0 = Forced, 1 = Not forced

*Note: This parameter is only visible if the **Activation of priority status object** parameter has the following value: **Active**.*

* Default value

Parameter	Description	Value
Emission	<p>The Status indication priority communication object is sent:</p> <p>On activation and deactivation of the Priority.</p> <p>Periodically after a configurable time.</p> <p>On activation and deactivation of the Priority and periodically after a configurable time.</p>	<p>On status change*</p> <p>Periodically</p> <p>On status change and periodically</p>

Note: This parameter is only visible if the **Activation of priority status object** parameter has the following value: **Active**.

Parameter	Description	Value
Hours (h)	This parameter determines the time between the individual transmissions of the Status indication priority object.	0 hours: 0 to 23 h
Minutes (min)		10 minutes: 0 to 59 min
Seconds (s)		0 seconds: 0 to 59 s

Note: The smallest executable time is 1 second.

Note: This parameter is only visible if the **Emission** parameter has the following value: **Periodically** or **On status change and periodically**.

Parameter	Description	Value
Status after priority	<p>At the end of the priority, the output is:</p> <p>Not changed.</p> <p>Switch to the opposite status.</p> <p>Selectively switched on.</p> <p>Selectively switched off.</p> <p>Switched back to the status before priority was activated.</p> <p>Switched to the status which would be active according to other communication objects if the priority had not taken place.</p>	<p>Maintain status*</p> <p>Inversion</p> <p>ON</p> <p>OFF</p> <p>Status before priority</p> <p>Theoretical status without priority</p>

Note: The application of this parameter depends on the priority of the other active functions. If a function with higher priority is active, this parameter will not be enacted. In the case where two functions with the same priority are active, the parameter of the most recently switched off function is enacted.

3.8.8 Hours counter

The Hours Counter function is used to count the overall operating time of an output in the ON or OFF state. The operating hours counter setpoint can be programmed and altered via an object.

Outputs 1-20: Function	Relay status for operating hours counter	<input type="radio"/> Opened <input checked="" type="radio"/> Closed
Outputs 1-20: General	Hours counter direction	<input checked="" type="radio"/> Increment <input type="radio"/> Countdown
- O1-20: Manual mode ON/OFF	Hours counter setpoint	10000
- O1-20: Status indications ON/OFF	Counter setpoint value modifiable through object	<input type="checkbox"/>
- O1-20: Status indications shutter	Hours counter objects unit	<input checked="" type="radio"/> Hours <input type="radio"/> Seconds
+ Outputs 1-2		
- Output 3	Emission hours counter value	On status change
Output 3: Function selection	Value interval	100 h
- O3: Hours counter	Emission object counter setpoint reached	Periodically
+ Output 4	Periodical emission delay	1 h
+ Output 5	Periodical emission delay	0 min
+ Output 6	Periodical emission delay	0 s

Parameter	Description	Value
Relay status for operating hours counter	The hours counter runs if: The output is closed. The output is open.	Closed* Opened

Parameter	Description	Value
Hours counter direction	The hours counter counts: Growing. Decreasing.	Increment* Countdown

Increment:

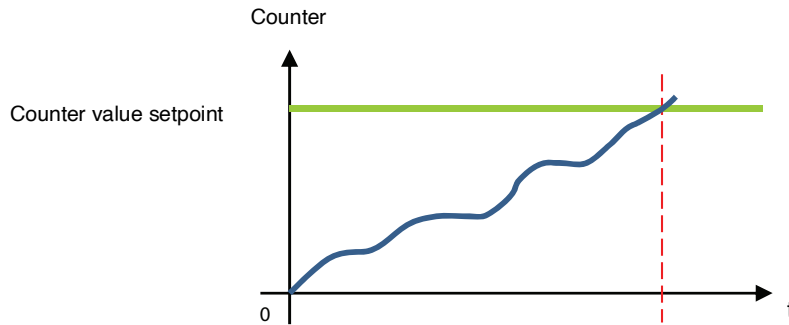

The counter starts to count up from the value 0. As soon as the counter setpoint (**Hours counter setpoint** object) is reached, the **Hours counter setpoint reached** object is set to 1 and sent to the bus.

Countdown:

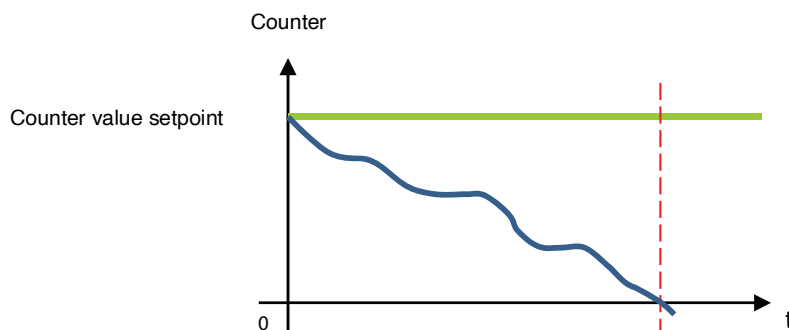

The counter starts to count down from the operating hours counter setpoint (**Hours counter setpoint** object). As soon as the counter reaches 0, the **Hours counter setpoint reached** is set to 1 and sent to the bus.

Parameter	Description	Value
Hours counter setpoint	This parameter determines the value of the hours counter.	1 ... 10000* ... 65535

An incrementing counter starts at 0 and counts up until it reaches the setpoint value.
A countdown counter starts to count at the setpoint value and counts down until it has arrived at 0.

Parameter	Description	Value
Counter setpoint value modifiable through object	The Hours counter setpoint communication object is hidden.	Not active*
	The Hours counter setpoint communication object is displayed. The value can be changed via the KNX bus.	Active

Parameter	Description	Value
Hours counter objects unit	Operating hours are counted in:	
	Hours	Hours*
	Seconds	Seconds

Communication objects: [17, 37, ... 397 - Output x - Hours counter value](#) (2 bytes - 7.007 DPT_Time(h))
[20, 40, ... 400 - Output x - Hours counter setpoint](#) (2 bytes - 7.007 DPT_Time(h))

Or

[17, 37, ... 397 - Output x - Hours counter value](#) (4 bytes - 13.100 DPT_Time lag (s))
[20, 40, ... 400 - Output x - Hours counter setpoint](#) (4 bytes - 13.100 DPT_Time lag (s))

Parameter	Description	Value
Emission hours counter value	The Hours counter value communication object is sent: On each change. Periodically after a configurable time. On change and periodically after a configurable time.	On status change* Periodically On status change and periodically

Parameter	Description	Value
Value interval (h)	This parameter specifies the value interval (in hours) for the sending frequency of the Hours counter setpoint object.	1 ... 100* ... 65535 (hours)

*Note: If the value interval is 200 hours, then the **Hours counter setpoint** object is sent each time the Operating h. counter value is increased by 200 hours.*

*Note: This parameter is only visible if the **Emission hours counter value** parameter has the following value: **Periodically** or **On status change and periodically**.*

Parameter	Description	Value
Periodical emission delay	This parameter determines the time between the individual transmissions of the Hours counter setpoint object.	1 hours: 0 to 23 h 0 minutes: 0 to 59 min 0 seconds: 0 to 59 s

Note: The smallest executable time is 1 second.

*Note: This parameter is only visible if the **Emission hours counter value** parameter has the following value: **Periodically** or **On status change and periodically**.*

Parameter	Description	Value
Emission object counter setpoint reached	The Hours counter setpoint reached communication object is sent: On reaching the counter setpoint. Periodically after a configurable time. On reaching the counter setpoint and periodically after a configurable time.	On status change Periodically* On status change and periodically

Parameter	Description	Value
Periodical emission delay	This parameter determines the time between the individual transmissions of the Hours counter setpoint reached object.	1 hours: 0 to 23 h 0 minutes: 0 to 59 min 0 seconds: 0 to 59 s

Note: The smallest executable time is 1 second.

*Note: This parameter is only visible if the Object **Emission counter setpoint reached** parameter has the following value: **Periodically** or **On status change and periodically**.*

* Default value

3.9 Functions for each shutter/blind output

Slat position for horizontal slats

The blind drive actuators have 2 limit position switches and can be run to a Sun protection position using a position setting in percent. The value of 0% is used to control the upper position (i.e. Sun protection fully open) or is reported as a status.

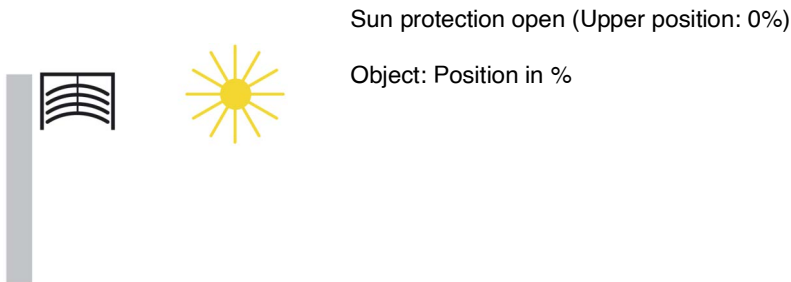

If the lower position is to be approached, then this will be sent to the blinds as Sun protection position 100% or on reaching the lower position (i.e. Sun protection completely closed). The position will be reported using this value. If a blind is run from the upper position, the slats initially tilt into an almost vertical position and then the sun protection runs with closed slats to the lower position.

When the blind is located at the lower position and the slats are fully closed, then this slat position is described as vertical and equal to 100%. Normally, however, fully closed slats have no exactly vertical position ($\alpha = 180^\circ$) but rather form a small angle with the vertical.

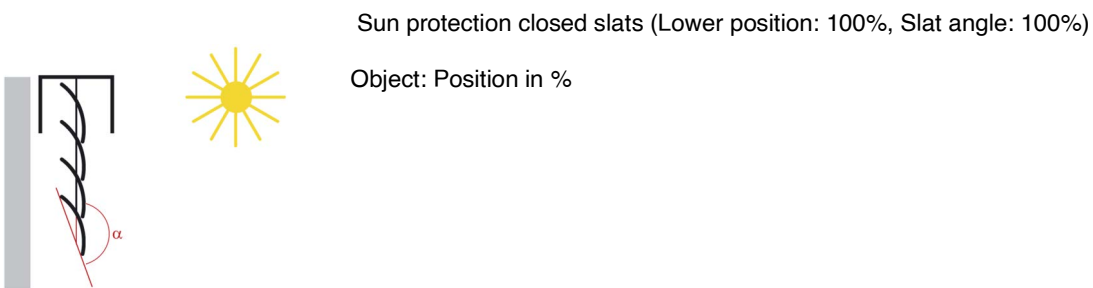

From their vertical position (completely closed, 100%) the slats can be adjusted to their horizontal position (fully open, 0% and $= 90^\circ$) The blind drive used thus determines whether this adjustment can be carried out using many small steps or whether it is only possible via a few large steps (As with most standard drives).

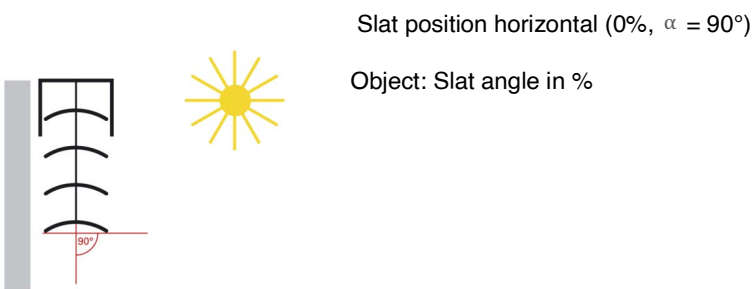

For standard blinds, the slats can be adjusted continuously to the horizontal position or until the slat adjustment ends and the raising of the blind begins. The slats then form an angle of between 0° and 90° with the vertical.

* Default value

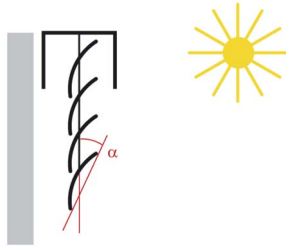

Slat position at the start of moving the blind (Up)

Object: Slat angle in %

Slat position for vertical slats

If an interior shade or privacy shield with vertical slats is controlled via a blind actuator, then the position in which the slats are fully open is controlled or reported as the 0% slat position. The slats then form an angle of 90° with the direction of travel from Shade fully open to Shade fully closed.



Fully opened vertical slats (Slat angle 0%)

Object: Slat angle in %

If the slats are fully closed, this position will be controlled and reported as slat position 100%. This is the position to which the shade is run from its side limit position in front of the window. The angle that the slats then form with the direction of movement is therefore a little $> 0^\circ$.

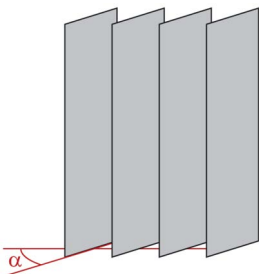

Fully closed vertical slats (Slat angle 100%)

Object: Slat angle in %

If the shade is then driven back (i.e. opened), then the vertical slats are turned to a position that is somewhat smaller than 180°.

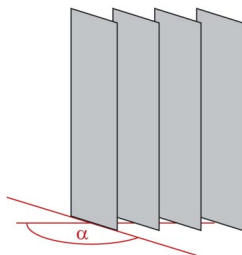

Vertical slats at the start of moving UP

* Default value

3.9.1 Function selection

These parameters are available individually for each output (Pair).

Outputs 1-20: Function	Closing type	<input type="radio"/> Shutter <input checked="" type="radio"/> Shutter and blind
Outputs 1-20: General	Complete up movement duration	2 min
- O1-20: Manual mode ON/OFF	Complete up movement duration	0 s
- O1-20: Status indications ON/OFF	Complete down movement duration	2 min
- O1-20: Status indications shutter	Complete down movement duration	0 s
— Outputs 1-2	Time delay for direction inversion	600 ms
Outputs 1-2: Function selection	Relay closing time for slat positioning	150 ms
+ Output 3	Total number of slat angles	12
+ Output 4	Secured down	<input type="checkbox"/>
+ Output 5	Manual mode active for output 1-2	<input checked="" type="checkbox"/>
+ Output 6	Status indication	<input checked="" type="checkbox"/>
+ Output 7	Status indication position in %	<input checked="" type="checkbox"/>
+ Output 8	Status indication slat angle in %	<input checked="" type="checkbox"/>
+ Output 9	Status indication upper position reached	<input type="checkbox"/>
+ Output 10	Status indication lower position reached	<input type="checkbox"/>
+ Output 11	Scene	<input type="checkbox"/>
+ Output 12	Lock-up	Not active
+ Output 13	Preset	Not active
+ Output 14	Priority	<input type="checkbox"/>
	Alarm	Not active
	Sun protection	<input type="checkbox"/>

Parameter	Description	Value
Closing type for channel x	This parameter defines the operating mode used for the affected outputs. An operating mode of the shutter and blind type gives access to additional parameters to control the slat pitch.	Shutter* Shutter and blind

x = 1 to 8

Note: These objects are always visible.

* Default value

Communication objects: **1, 41, ... 361 - Outputs x-y - Up/Down (Long key-press)** (1 bit - 1.008 DPT_UpDown)
2, 42, ... 362 - Outputs x-y - Step/stop (Short press) (1 bit - 1.007 DPT_Step)
3, 43, ... 363 - Outputs x-y - Position in % (1 byte - 5.001 DPT_Percentage)

*Note: These objects are only visible if the **Closing type for channel x** parameter has the following value: **Shutter and blind**.*

Communication objects: **4, 44, ... 364 - Outputs x-y - Slat angle (0-100%)** (1 byte - 5.001 DPT_Percentage)

Parameter	Description	Value
Complete up movement duration	This parameter defines the time taken, during which the contact must be closed, to reach the upper position.	2 minutes: 0 to 59 min 0 seconds: 0 to 59 s

Note: The smallest executable time is 1 second.

Parameter	Description	Value
Complete down movement duration	This parameter defines the time taken, during which the contact must be closed, to reach the lower position.	2 minutes: 0 to 59 min 0 seconds: 0 to 59 s

Note: The smallest executable time is 1 second.

Parameter	Description	Value
Time delay for direction inversion (ms)	This parameter defines how long the shutter or blind must be stopped before the direction of motion can be reversed. During this time, 2 output contacts are open.	300 ... 600* ... 10000 ms

* Default value

Parameter	Description	Value
Relay closing time for slat positioning (ms)	This parameter defines how long the contacts must be closed in order to perform an elementary angle step for the slats.	50 ... 150* ... 10000 ms

Note: These objects are only visible if the **Closing type for channel x** parameter has the following value: **Shutter and blind**.

Parameter	Description	Value
Total number of slat angles	This parameter defines the total number of elementary slat steps available for adjusting the slats from the inclined downwards position to be inclined upwards position.	1 ... 12* ... 60

Note: Before setting the **Total number of slat angles** parameter, it is essential to first set the closed contact duration for an elementary slat step.

Note: These objects are only visible if the **Closing type for channel x** parameter has the following value: **Shutter and blind**.

Parameter	Description	Value
Secured down	In manual mode, the down contact remains closed only as long as the manual button is being pressed.	Not active* Active

Note: This function is also used in order to give the command to close a swimming pool cover, which for safety reasons also requires a continuous button press.

Parameter	Description	Value
Manual mode active for output X	With this parameter, manual mode can be authorized for the output.	Yes* No

X = 1 to 8

Parameter	Description	Value
Status indication	This parameter allows the display of different status indication objects of the outputs concerned.	Yes* No

Parameter	Description	Value
Status indication position in %	This parameter authorizes the Position in % indication object.	Not active* Active

Communication objects: [5, 45, ... 365 - Outputs x-y - Position indication in % \(1 byte - 5.001 DPT_Percentage\)](#)

* Default value

Parameter	Description	Value
Status indication slat angle in %	This parameter authorizes the Slat angle indication in % object.	Not active* Active

Note: This parameter is only visible if the **Closing type for channel x** parameter has the following value: **Shutter and blind**.

Communication objects: [6, 46, ... 366 - Outputs x-y - Slat angle indication in % \(1 byte - 5.001 DPT_Percentage\)](#)

Parameter	Description	Value
Status indication upper position reached	This parameter authorizes the Upper position reached object.	Not active* Active

Communication objects: [7, 47, ... 367 - Outputs x-y - Upper position reached \(1 bit - 1.002 DPT_Bool\)](#)

Parameter	Description	Value
Status indication lower position reached	This parameter authorizes the Lower position reached object.	Not active* Active

Communication objects: [8, 48, ... 368 - Outputs x-y - Lower position reached \(1 bit - 1.002 DPT_Bool\)](#)

Parameter	Description	Value
Scene	The Scenes tab and the associated parameters and objects are: Hidden. Displayed.	Not active* Active

* Default value

Communication objects: [9, 49, ... 369 - Outputs x-y - Scene](#) (1 byte - 18.001 DPT_SceneControl)

For configuration see section: [Scene Shutter](#).

Parameter	Description	Value
Lock-up	The Lock-up tab and the associated parameters and objects are: Hidden. Displayed for 1 lock-up object. Displayed for 2 lock-up objects.	Not active* 1 lock-up object 2 lock-up objects

Lock-up 1 communication objects [14, 54, ... 374 - Outputs x-y - Lock-up 1](#) (1 bit - 1.003 DPT_Enable)

Lock-up 2 communication objects [15, 55, ... 375 - Outputs x-y - Lock-up 2](#) (1 bit - 1.003 DPT_Enable)

For configuration see section: [Lock-up Shutter](#).

Parameter	Description	Value
Preset	The Preset tab and the associated parameters and objects are: Hidden. Displayed for 1 Preset object. Displayed for 2 Preset objects.	Not active* Active with preset 1-level object Active with preset 2-level objects

Note: When the value of this parameter changes, the associated parameters and group addresses are deleted.

* Default value

Preset 1 communication Objects [10, 50, ... 370 - Outputs x-y - Preset 1](#) (1 bit - 1.022 DPT_Scene)

Preset 2 communication Objects [11, 51, ... 371 - Outputs x-y - Preset 2](#) 1 bit - 1.022 DPT_Scene)

For configuration see section: [Preset Shutter](#).

Parameter	Description	Value
Priority	The Priority tab and the associated parameters and objects are: Hidden. Displayed.	Not active* Active

The device responds to telegrams received via the **Priority** object, as given in the following table:

Telegram received by the priority operation object		Status of the outputs
Bit 1	Bit 2	
0	0	End of the priority
0	1	End of the priority
1	0	Priority OFF
1	1	Priority ON

Communication objects: [17, 57, ... 377 - Outputs x-y - Priority](#) (2 bit - 2.002 DPT_Bool_Control)

For configuration see section: [Priority Shutter](#).

* Default value

Parameter	Description	Value
Alarm	The Alarm tab and the associated parameters and objects are: Hidden. Displayed for 1 alarm object Displayed for 2 alarm objects Displayed for 3 alarm objects	Not active* 1 alarm object 2 alarm objects 3 alarm objects

Communication objects: [19, 59, ... 379 - Outputs x-y - Alarm 1 \(1 bit- 1.005 DPT_Alarm\)](#)

[20, 60, ... 380 - Outputs x-y - Alarm 2 \(1 bit- 1.005 DPT_Alarm\)](#)

[21, 61, ... 381 - Outputs x-y - Alarm 3 \(1 bit- 1.005 DPT_Alarm\)](#)

For configuration see section: [Alarm](#).

Parameter	Description	Value
Sun protection	The Reactivate sun protection tab and the associated parameters and objects are: Hidden. Displayed.	Not active* Active

Communication objects: [23, 63, ... 383 - Outputs x-y - Sun protection position % \(1 byte - 5.001 DPT_Percentage\)](#)

* Default value

Communication objects: **24, 64, ... 384 - Outputs x-y - Sun protection slat angle % (1 byte - 5.001 DPT_Percentage)**

For configuration see section: [Sun protection](#).

3.9.2 Scene

Outputs 1-20: Function	Number of scenes used	8
Outputs 1-20: General	Scenes memorisation by long key press	<input checked="" type="checkbox"/>
- O1-20: Manual mode ON/OFF	Scenes memorisation acknowledgment (Output status inverted for 3s)	<input type="checkbox"/>
- O1-20: Status indications ON/OFF		
- O1-20: Status indications shutter		
- Outputs 1-2		
Outputs 1-2: Function selection		
- O1-2: Scenes	Position for scene 1	Not active
+ Output 3	Position for scene 2	Not active
+ Output 4	Position for scene 3	Not active
+ Output 5	Position for scene 4	Not active
+ Output 6	Position for scene 5	Not active
+ Output 7	Position for scene 6	Not active
+ Output 8	Position for scene 7	Not active
	Position for scene 8	Not active

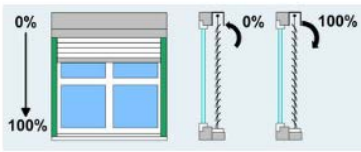

The diagram illustrates the sun protection slat angle adjustment. On the left, a window with a blue sky view is shown with a vertical arrow indicating the slat angle, ranging from 0% (fully open) to 100% (fully closed). On the right, two vertical mechanisms are shown, each with a curved arrow indicating the slat angle, ranging from 0% to 100%.

Parameter	Description	Value
Number of scenes used	This parameter determines the number of scenes used.	8* - 16 - 24 - 32 - 48 - 64

Note: If the Scene number received on the Scene object is greater than the maximum number of scenes, the status of the output remains unchanged.

Parameter	Description	Value
Scenes memorisation by very long key press	This parameter allows learning and storing of a scene by, for example, a long press (> 5 seconds) of the corresponding push button.	Not active Active*

* Default value

Learning and storing scenes

This process is used to change and store a scene. For example, by locally pressing the key in the room or by emission of the values from a visualization.

To access and store scenes, the following values must be sent:

Scene number	Access scene (Object value: 1 byte)	Store scene (Object value: 1 byte)
1 - 64	= Scene number - 1	= Scene number + 128
Example		
1	0	128
2	1	129
3	2	130
...	...	
64	63	191

Here is the scene memorisation for local switches, for example.

- Activate scene by briefly pressing the transmitter that starts it.
- The outputs (lights, shutters, etc.) are set in the desired state using the usual local control devices (buttons, remote control, etc.).
- Memorise the status of the outputs with a press greater than 5 seconds long on the transmitter that starts the scene. The memorisation can be displayed by short-term activation of the outputs.

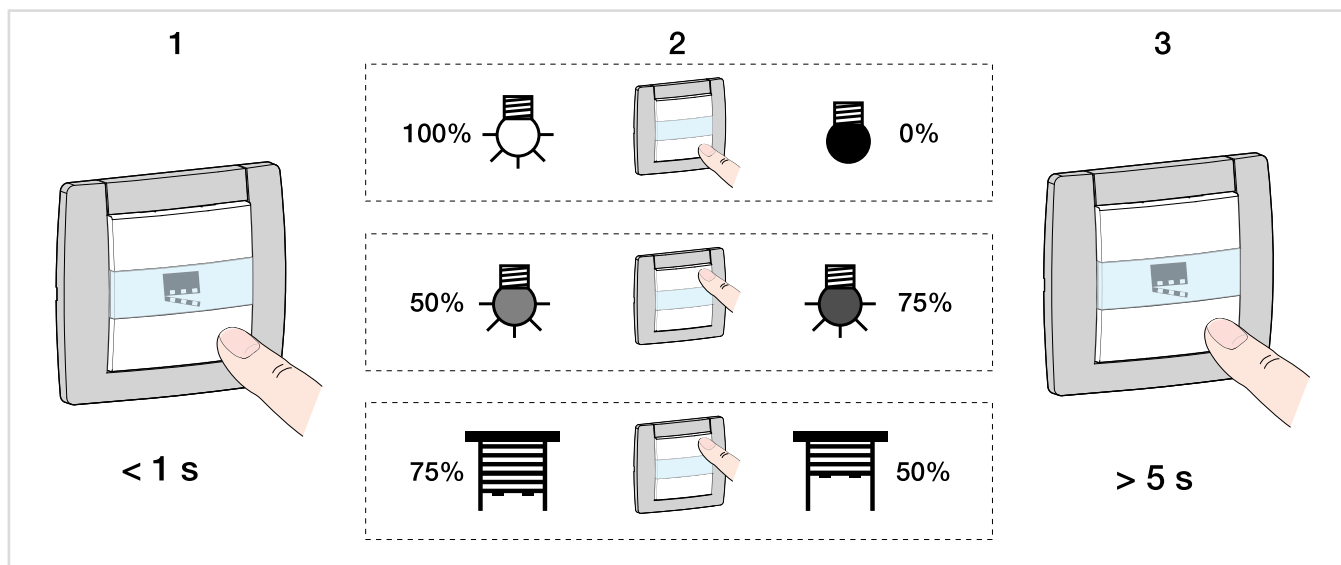

Parameter	Description	Value
Scenes memorisation acknowledgment	Memorisation of a scene is: Not acknowledged. Acknowledged by the output by a 3 second long inversion of the output status.	Not active* Active

* Default value

Parameter	Description	Value
Position for scene X	On activation of Scene X, the output is: Not changed. Closes the Up contact. Closes the down contact. Runs to a specific position. Reactivate the sun protection function. Lock-up the Sun protection function.	Not active* Up Down Specific position Sun protection reactivation Deactivation sun protection

X = 1 to 64

*Note: Each output has up to 64 scenes available, in accordance with the **Number of scenes used** parameter.*

Note: The Sun protection function of the selected output must be configured. If this is not the case, the status remains unchanged. If this is not the case, the status remains unchanged.

*Note: Local storage of the scene is not recorded if the **Position for scene X** parameter is not active.*

Parameter	Description	Value
Position (0-100%)	This parameter defines the position to run the shutter or blind to for scene X.	0 ... 5* ... 100

*Note: This parameter is only visible if the **Position for scene X** parameter has the following value: **Specific position**.*

Parameter	Description	Value
Slat angle (0-100%)	This parameter defines the slat position of the blind to be used for scene X.	0 ... 5* ... 100

*Note: This parameter is only visible if the **Position for scene X** parameter has the value **Specific position** and if the **Closing type for channel** parameter has the value **blind**.*

* Default value

3.9.3 Lock-up

Outputs 1-20: Function	Lock-up type	<input checked="" type="radio"/> Output lock-up <input type="radio"/> Object lock-up
Outputs 1-20: General	Lock-up duration	<input type="radio"/> Time limited <input checked="" type="radio"/> Permanently
- O1-20: Manual mode ON/OFF	Priority between lock-up 1 and lock-up 2	Lock-up 1 > Lock-up 2
- O1-20: Status indications ON/OFF	Activation of lock-up status object	<input checked="" type="checkbox"/>
- O1-20: Status indications shutter	Polarity	<input checked="" type="radio"/> 0 = Lock-up deactivated, 1 = Lock-up activated <input type="radio"/> 0 = Lock-up activated, 1 = Lock-up deactivated
- Outputs 1-2	Emission	On status change and periodically
Outputs 1-2: Function selection	Hours	0 h
- O1-2: Lock-up	Minutes	10 min
+ Output 3	Seconds	0 s
+ Output 4	Polarity of lock-up object 1	<input checked="" type="radio"/> 0 = Lock-up deactivated, 1 = Lock-up activated <input type="radio"/> 0 = Lock-up activated, 1 = Lock-up deactivated
+ Output 5	Position during lock-up 1	Maintain status
+ Output 6	Position after lock-up function 1	Maintain status
+ Output 7	Polarity of lock-up object 2	<input checked="" type="radio"/> 0 = Lock-up deactivated, 1 = Lock-up activated <input type="radio"/> 0 = Lock-up activated, 1 = Lock-up deactivated
+ Output 8	Position during lock-up 2	Maintain status
+ Output 9	Position after lock-up function 2	Maintain status

The Lock-up function is used to lock the output in a predefined state.
 Priority: Manual mode > Priority > **Lock-up** > Basic function.
 The Lock-up prevents actuation until an unlock command has been received.
 The Lock-up duration can be set.

Parameter	Description	Value
Lock-up type	<p>The Lock-up acts:</p> <p>Directly on the switch actuator. As long as the Lock-up is active, the output can only be controlled by higher priority commands.</p> <p>On selected communication objects. As long as the Lock-up is active, the output can only be controlled via specific selectable objects.</p>	<p>Output lock-up*</p> <p>Object lock-up</p>

* Default value

Parameter	Description	Value
Lock-up duration	The duration of the Lock-up is Not time limited, the lock-up is only authorized by means of a telegram on Lock-up 1 object. Is active for a limited time, the control of the output is authorized after expiry of this time.	Permanently* Time limited

Parameter	Description	Value
Hours (h)	This parameter determines the activation time of the Lock-up.	0 hours: 0 to 23 h
Minutes (min)		15 minutes: 0 to 59 min
Seconds (s)		0 seconds: 0 to 59 s

Note: The smallest executable time is 1 second.

Note: This parameter is only visible if the **Lock-up duration** parameter has the following value: **Time limited**.

Parameter	Description	Value
Polarity of lock-up object 1	On receipt of a value on the Lock-up 1 object, the lock-up: Is activated on object value 1. Is deactivated on object value 0. Is activated on object value 0. Is deactivated on object value 1.	0 = Lock-up deactivated, 1 = Lock-up activated* 0 = Lock-up activated, 1 = Lock-up deactivated

Note: The parameters and objects are identical for Lock-up 2 ; Only the terms will be adjusted.

Parameter	Description	Value
Priority between lock-up 1 and lock-up 2	The priority between lock-up 1 and lock-up 2 is set as follows: Lock-up 1 has priority over lock-up 2. Lock-up 2 has priority over lock-up 1. Lock-up 1 and lock-up 2 have the same priority.	Lock-up 1 > Lock-up 2* Lock-up 1 < Lock-up 2 Lock-up 1 = Lock-up 2

Note: This parameter is only visible if the **Lock-up** parameter has the following value: **Active with 2 lock-up objects**.

Note: The priority of the Lock-up always functions in the same way, independently of the lock-up type (Output lock-up or object lock-up).

* Default value

Operating principle of the priorities:
If Lock-up 1 > Lock-up 2

Active lock-up	Activation order of Lock-up 1	Activation order of Lock-up 2
None	Lock-up 1 is activated	Lock-up 2 is activated
Lock-up 1	Lock-up 1 remains active	Despite the activation order of Lock-up 2, Lock-up 1 remains activated
Lock-up 2	Lock-up 1 is activated	Lock-up 2 remains active

If Lock-up 1 = Lock-up 2

Active lock-up	Activation order of Lock-up 1	Activation order of Lock-up 2
None	Lock-up 1 is activated	Lock-up 2 is activated
Lock-up 1	Lock-up 1 remains active	Lock-up 2 is activated
Lock-up 2	Lock-up 1 is activated	Lock-up 2 remains active

If Lock-up 1 < Lock-up 2

Active lock-up	Activation order of Lock-up 1	Activation order of Lock-up 2
None	Lock-up 1 is activated	Lock-up 2 is activated
Lock-up 1	Lock-up 1 remains active	Lock-up 2 is activated
Lock-up 2	Despite the activation order of Lock-up 1, Lock-up 2 remains activated	Lock-up 2 remains active

Parameter	Description	Value
Position during lock-up 1	During Lock-up 1, the shutter/blind output: Not changed. Closes the Up contact. Closes the down contact. Opens the 2 contacts. Runs to a specific position.	Maintain status* Up Down Stop Specific position

Note: The parameters and objects are identical for Lock-up 2 ; Only the terms will be adjusted.

Parameter	Description	Value
Position (0-100%)	This parameter defines the position to run the shutter or blind to.	0 ... 5* ... 100

*Note: This parameter is only visible if the **Position during lock-up 1]** parameter has the following value: **Specific position**.*

Parameter	Description	Value
Slat angle (0-100%)	This parameter defines the slat position to use for the blind.	0 ... 5* ... 100

*Note: This parameter is only visible if the **Position during lock-up 1** parameter has the value **Specific position** and if the **Closing type for channel** parameter has the value **blind**.*

Lock-up 1 authorizes object:

The parameters listed below allow the selection of the objects for controlling the output via the nevertheless active Lock-up.

*Note: These parameters are only visible if the **Lock-up type** parameter has the following value: **Object lock-up**.*

Parameter	Objects concerned	Value
Up/down	Up/Down (long key-press)	Yes No*
Slat angle/stop	Step/stop (short press)	Yes No*
Scene	Scene	Yes No*
Position in %	Position in %	Yes No*
Slat angle in %	Slat angle in %	Yes No*
Sun protection position in %	Sun protection position in %	Yes No*
Sun protection slat angle in %	Slat angle (0-100%)	Yes No*
Preset 1	Preset 1	Yes No*
Preset 2	Preset 2	Yes No*

Note: The parameters and objects are identical for Lock-up 2 ; Only the terms will be adjusted.

Parameter	Description	Value
Position after lock-up function 1	<p>After lock-up 1, the shutter/blind output: Not changed.</p> <p>Closes the Up contact.</p> <p>Closes the down contact.</p> <p>Runs to a specific position.</p> <p>Returns to the position before lock-up 1.</p> <p>Runs to the position which would be active according to other communication objects if lock-up 1 had not taken place.</p>	<p>Maintain status*</p> <p>Up</p> <p>Down</p> <p>Specific position</p> <p>Status before lock-up</p> <p>Theoretical status without lock-up function 1</p>

*Note: On **Theoretical status without lock-up function 1**, the Up/Down and slat step commands are not saved.*

Note: The parameters and objects are identical for Lock-up 2 ; Only the terms will be adjusted.

Parameter	Description	Value
Position (0-100%)	This parameter defines the position to run the shutter or blind to.	0 ... 5* ... 100

*Note: This parameter is only visible if the **Position after lock-up function 1** parameter has the following value: **Specific position**.*

* Default value

Parameter	Description	Value
Slat angle (0-100%)	This parameter defines the slat position to use for the blind.	0 ... 5* ... 100

*Note: This parameter is only visible if the **Position after lock-up function 1** parameter has the value **Specific position** and if the **Closing type for channel** parameter has the value **blind**.*

Parameter	Description	Value
Activation of lock-up status object	The Status indication lock-up communication object is hidden.	Not active*
	The Status indication lock-up communication object is displayed.	Active

Communication objects: [16, 56, ... 376 - Outputs x-y - Status indication lock-up \(1 bit - 1.011 DPT_State\)](#)

Parameter	Description	Value
Polarity	The Status indication Lock-up communication object sends: 0 on deactivation of the lock-up. 1 on activation of the lock-up. 0 on activation of the lock-up. 1 on deactivation of the lock-up.	0 = Lock-up deactivated, 1 = Lock-up activated* 0 = Lock-up activated, 1 = Lock-up deactivated

Parameter	Description	Value
Emission	The Status indication lock-up communication object is sent: On activation and deactivation of the lock-up. Periodically after a configurable time. On activation and deactivation of the lock-up and periodically after a configurable time.	On status change* Periodically On status change and periodically

*Note: This parameter is only visible if the **Activation of Lock-up status object** parameter has the following value: **Active**.*

Parameter	Description	Value
Hours (h)	This parameter determines the time between the individual transmissions of the Status indication lock-up object.	0 hours: 0 to 23 h
Minutes (min)		10 minutes: 0 to 59 min
Seconds (s)		0 seconds: 0 to 59 s

Note: The smallest executable time is 1 second.

*Note: This parameter is only visible if the **Emission** parameter has the following value: **Periodically** or **On status change and periodically**.*

* Default value

3.9.4 Preset

Outputs 1-20: Function	Preset authorization objects	<input checked="" type="checkbox"/>
Outputs 1-20: General	Value of authorization preset 1 at initialization	Value before initialization
- O1-20: Manual mode ON/OFF	Value of authorization preset 2 at initialization	Value before initialization
- O1-20: Status indications ON/OFF	Polarity of Preset 1 authorization object	<input checked="" type="radio"/> 0 = Locked-up , 1 = Authorized <input type="radio"/> 0 = Authorized, 1 = Locked-up
- O1-20: Status indications shutter	Polarity of Preset 2 authorization object	<input checked="" type="radio"/> 0 = Locked-up , 1 = Authorized <input type="radio"/> 0 = Authorized, 1 = Locked-up
- Outputs 1-2		
Outputs 1-2: Function selection	Position if preset 1 = 0	Scene number
- O1-2: Preset	Scene for preset 1 = 0	1
+ Output 3	Position if preset 1 = 1	Specific position
+ Output 4	Position (0-100%)	100
+ Output 5	Slat angle (0-100%)	100
+ Output 6	Position if preset 2 = 0	Maintain status
+ Output 7	Position if preset 2 = 1	Maintain status

The Preset function is used to switch an output into various predefined states. The Preset function is activated via an object in 1-bit format.

Principle of Preset authorization:

The parameters are set as follows:

- Polarity of Preset 1 authorization object: 0 = Locked-up, 1 = Authorized.
- Polarity of Preset 2 authorization object: 0 = Locked-up, 1 = Authorized.
- Position in % if preset 1 = 0: Shutter DOWN.
- Position in % if preset 1 = 1: Shutter UP.
- Position in % if preset 2 = 0: Scene 1.
- Position in % if preset 2 = 1: Scene 2.

* Default value

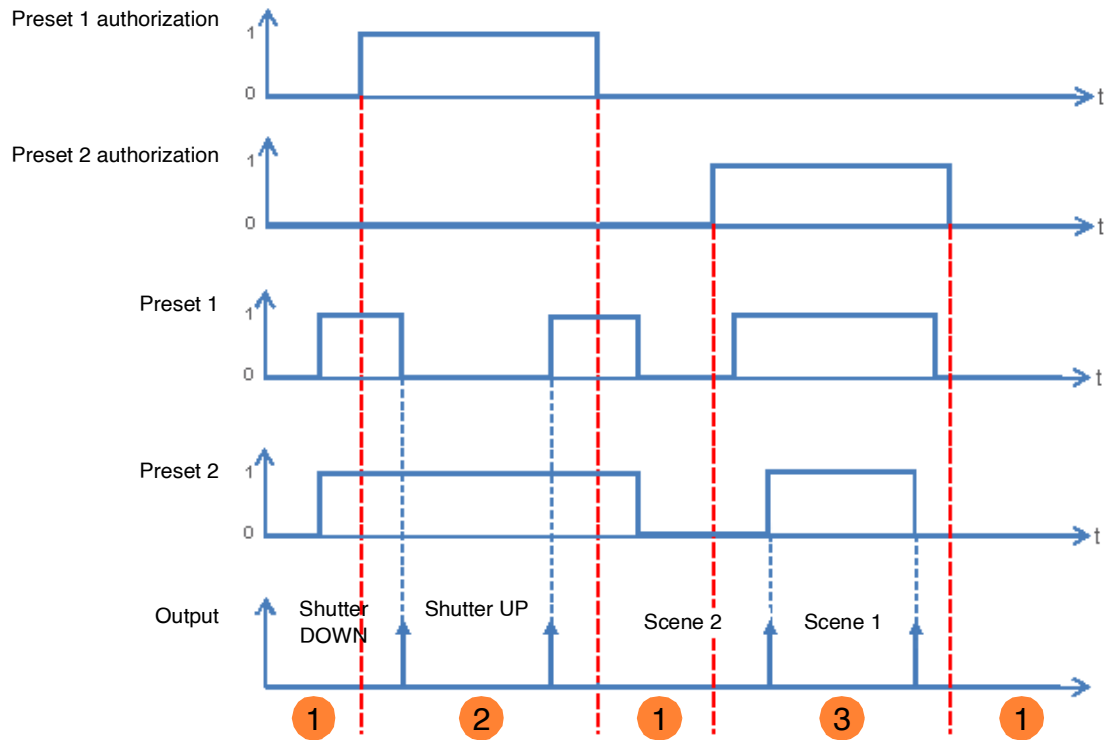

- ❶ The preset inputs have no influence on the output.
- ❷ The commands from Preset 1 are executed.
- ❸ The commands from Preset 2 are executed.

Note: The commands from the Preset will not be executed immediately after authorization, but only when the value of the Preset changes.

Parameter	Description	Value
Preset authorization objects	The Preset 1 authorization communication object and the related parameters are: Hidden. Displayed. This object allows the authorization or lock-up of the Preset 1 function via a KNX telegram.	Not active* Active

Note: The number of available Preset objects is dependent on the **Preset** parameter. A maximum of two of these objects can be available.

Communication objects: [12, 52, ... 372 - Outputs x-y - Preset 1 authorization \(1 bit - 1.003 DPT_Enable\)](#)

* Default value

Communication objects: [13, 53, ... 373 - Outputs x-y - Preset 2 authorization \(1 bit - 1.003 DPT_Enable\)](#)

Note: The parameters and objects are identical for Preset 2 ; Only the terms will be adjusted.

Parameter	Description	Value
Value of authorization preset 1 at initialization	On initialization of the device after a download or after return of the bus power, the value of the Preset 1 authorization object is: Set to 0. Set to 1. Set according to the value of the logic input before the initialization occurred.	0 1 Value before initialization*

*Note: This parameter is only visible if the **Preset authorization objects** parameter has the following value: **Active**.*

Parameter	Description	Value
Polarity of Preset 1 authorization object	On receipt of a value on the Preset 1 authorization object, Preset 1 : Locked-up on object value 1. Locked-up on object value 0.	0 = Locked-up, 1 = Authorized* 0 = Authorized, 1 = Locked-up

*Note: This parameter is only visible if the **Preset authorization objects** parameter has the following value: **Active**.*

Parameter	Description	Value
Position in % if preset 1 = 0	During Preset 1 = 0 , the shutter/blind output: Not changed. Closes the Up contact. Closes the down contact. Opens the 2 contacts. Runs to a specific position. Runs to a position set in a scene. Reactivate the sun protection function. Lock-up the Sun protection function. Runs back to the position for Preset 1 = 1	Maintain status* Up Down Stop Specific position Scene number Activate sun protection Deactivation sun protection Status before preset 1 = 1

* Default value

Parameter	Description	Value
Position (0-100%)	This parameter defines the position to run the shutter or blind to.	0* ... 100

Note: This parameter is only visible if the **Position in % if preset 1 = 0** parameter has the following value: **Specific position**.

Parameter	Description	Value
Slat angle (0-100%)	This parameter defines the slat position to use for the blind.	0* ... 100

Note: This parameter is only visible if the **Position in % if preset 1 = 0** parameter has the value **Specific position** and if the **Closing type for channel** parameter has the value **blind**.

Parameter	Description	Value
Scene number for preset 1 = 0	This parameter determines the value of the scene if: The Preset 1 object has value 0. The Status if preset 1 object = 0 object has the scene value.	Scene 1 ... 64 Default value: 1

Parameter	Description	Value
Position in % if preset 1 = 1	During Preset 1 = 0 , the shutter/blind output Not changed. Closes the Up contact. Closes the down contact. Opens the 2 contacts. Runs to a specific position. Runs to a position set in a scene. Reactivate the sun protection function. Lock-up the Sun protection function. Runs back to the position for Preset 1 = 0	Maintain status* Up Down Stop Specific position Scene number Activate sun protection Deactivation sun protection Status before preset 1 = 0

Parameter	Description	Value
Position (0-100%)	This parameter defines the position to run the shutter or blind to.	0* ... 100

Note: This parameter is only visible if the **Position in % if preset 1 = 1** parameter has the following value: **Specific position**.

* Default value

Parameter	Description	Value
Slat angle (0-100%)	This parameter defines the slat position to use for the blind.	0* ... 100

*Note: This parameter is only visible if the **Position in % if preset 1 = 1** parameter has the value **Specific position** and if the **Closing type for channel** parameter has the value **blind**.*

Parameter	Description	Value
Scene number for preset 1 = 1	This parameter determines the value of the scene if: The Preset 1 object has value 1. The Status if preset 1 object = 1 object has the scene value.	Scene 1 ... 64 Default value: 2

* Default value

3.9.5 Priority

Outputs 1-20: Function	Activation of priority status object	<input checked="" type="checkbox"/>
Outputs 1-20: General	Polarity	<input checked="" type="radio"/> 0 = Not forced, 1 = Forced <input type="radio"/> 0 = Forced, 1 = Not forced
- O1-20: Manual mode ON/OFF	Emission	On status change and periodically
- O1-20: Status indications ON/OFF	Hours	0 h
- O1-20: Status indications shutter	Minutes	10 min
- O1-20: Status indications shutter	Seconds	0 s
— Outputs 1-2		
Outputs 1-2: Function selection	Position after priority	Maintain status
- O1-2: Priority		

The Priority is used to force the output into a predefined state.

Priority: Manual mode > **Priority** > Lock-up > Basic function.

No other command is taken into account when the Priority is active. Only by ending the Priority are other commands again permitted.

Parameter	Description	Value
Activation of priority status object	The Status indication priority communication object and related parameters are hidden.	Not active*
	The Status indication priority communication object and related parameters are displayed.	Active

Communication objects: [18, 58, ... 378 - Outputs x-y - Status indication priority \(1 bit - 1.011 DPT_State\)](#)

Parameter	Description	Value
Polarity	The Status indication priority communication object sends: 0 on deactivation of the Priority. 1 on activation of the Priority. 0 on activation of the Priority. 1 on deactivation of the Priority.	0 = Not forced, 1 = Forced* 0 = Forced, 1 = Not forced

*Note: This parameter is only visible if the **Activation of priority status object** parameter has the following value: **Active**.*

* Default value

Parameter	Description	Value
Emission	The Status indication priority communication object is sent: On activation and deactivation of the Priority. Periodically after a configurable time. On activation and deactivation of the Priority and periodically after a configurable time.	On status change* Periodically On status change and periodically

Note: This parameter is only visible if the **Activation of priority status object** parameter has the following value: **Active**.

Parameter	Description	Value
Hours (h)	This parameter determines the time between the individual transmissions of the Status indication priority object.	0 hours: 0 to 23 h
Minutes (min)		10 minutes: 0 to 59 min
Seconds (s)		0 seconds: 0 to 59 s

Note: The smallest executable time is 1 second.

Note: This parameter is only visible if the **Emission** parameter has the following value: **Periodically** or **On status change and periodically**.

Parameter	Description	Value
Position after priority	After Priority, the shutter/blind output: Not changed. Closes the Up contact. Closes the down contact. Runs to a specific position. Returns to the Position before priority. Runs to the position which would be active according to other communication objects if the priority had not taken place.	Maintain status* Up Down Specific position Status before priority Theoretical status without priority

Parameter	Description	Value
Position (0-100%)	This parameter defines the position to run the shutter or blind to on disappearing of the priority.	0 ... 5* ... 100

Note: This parameter is only visible if the **Position after priority** parameter has the following value: **Specific position**.

Parameter	Description	Value
Slat angle (0-100%)	This parameter defines the slat position to apply to the blind on disappearing of the priority.	0 ... 5* ... 100

Note: This parameter is only visible if the **Position after priority** parameter has the value **Specific position** and if the **Closing type** for channel parameter has the value **blind**.

* Default value

3.9.6 Alarm

Outputs 1-20: Function	Alarm 1	<input type="radio"/> Time limited <input checked="" type="radio"/> Permanently
Outputs 1-20: General	Position on alarm 1	Maintain status
- O1-20: Manual mode ON/OFF	Position after alarm 1	Maintain status
- O1-20: Status indications ON/OFF	Alarm 2	<input type="radio"/> Time limited <input checked="" type="radio"/> Permanently
- O1-20: Status indications shutter	Position on alarm 2	Maintain status
- Outputs 1-2	Position after alarm 2	Maintain status
Outputs 1-2: Function selection	Alarm 3	<input type="radio"/> Time limited <input checked="" type="radio"/> Permanently
- O1-2: Alarm	Position on alarm 3	Maintain status
+ Output 3	Position after alarm 3	Maintain status
+ Output 4	Priority between alarm 1, 2 and 3	Alarm 1 > Alarm 2 > Alarm 3
+ Output 5	Alarm status object	<input checked="" type="checkbox"/>
+ Output 6	Polarity	<input checked="" type="radio"/> 0 = Alarm deactivated, 1 = Alarm activated <input type="radio"/> 0 = Alarm activated, 1 = Alarm deactivated
+ Output 7	Emission	On status change
+ Output 8	Alarm monitoring period	<input checked="" type="checkbox"/>
+ Output 9	Hours	0 h
+ Output 10	Minutes	30 min
+ Output 11	Seconds	0 s

3.9.6.1 Alarm 1 to 3

Parameter	Description	Value
Alarm X	This parameter defines whether the Alarm function is active permanently or time-limited.	Permanently* Time limited

Permanently: The function is active until receipt of an alarm cancellation.

Time limited: The function is activated for a given period. At the end of this delay, the alarm is no longer active. To switch the Alarm function on again for a given period, a new activation of the function is required.

Parameter	Description	Value
Hours (h)	This parameter determines the activation time of the Alarm function.	0 hours: 0 to 23 h
Minutes (min)		30 minutes: 0 to 59 min
Seconds (s)		0 seconds: 0 to 59 s

Note: The smallest executable time is 1 second.

*Note: This parameter is only visible if the **Alarm X** parameter has the following value: **Time limited**.*

* Default value

Parameter	Description	Value
Position on alarm X	On Alarm X, the shutter/blind output: Not changed. Closes the Up contact. Closes the down contact. Opens the 2 contacts. Runs to a specific position. Runs to a position set in a scene.	Maintain status* Up Down Stop Specific position Scene number

X = 1 to 3

Parameter	Description	Value
Position (0-100%)	This parameter defines the position to run the shutter or blind to on triggering of the relevant alarms.	0 ... 5* ... 100

Note: This parameter is only visible if the **Position on alarm X** parameter has the following value: **Specific position**.

Parameter	Description	Value
Slat angle (0-100%)	This parameter defines the slat position to apply to the blind on triggering of the relevant alarm.	0 ... 5* ... 100

Note: This parameter is only visible if the **Position on alarm X** parameter has the value **Specific position** and if the **Closing type** for channel parameter has the value **blind**.

Parameter	Description	Value
Scene	This parameter defines the scene number to be activated on triggering of the relevant alarm.	Scene 1 ... 64 Default value: 1

X = 1 to 3

The outputs respond according to the scene numbers and associated parameters.

Note: This parameter is only visible if the **Position on alarm X** parameter has the following value: **Scene**.

Parameter	Description	Value
Position after alarm X	After Alarm X, the shutter/blind output: Not changed. Closes the Up contact. Closes the down contact. Opens the 2 contacts. Runs to a specific position. Runs to a position set in a scene. Returns to the Position before alarm. Runs to the position which would be active according to other communication objects if the alarm had not taken place.	Maintain status* Up Down Stop Specific position Scene number Position before alarm Theoretical status without alarm X

X = 1 to 3

* Default value

Parameter	Description	Value
Position (0-100%)	This parameter defines the position to run the shutter or blind to on disappearing of the relevant alarms.	0 ... 5* ... 100

*Note: This parameter is only visible if the **Position after alarm X** parameter has the following value: **Specific position**.*

Parameter	Description	Value
Slat angle (0-100%)	This parameter defines the slat position to apply to the blind on disappearing of the relevant alarm.	0 ... 5* ... 100

*Note: This parameter is only visible if the **Position after alarm X** parameter has the value **Specific position** and if the **Closing type** for channel parameter has the value **blind**.*

Parameter	Description	Value
Scene	This parameter defines the scene number to be activated on disappearing of the relevant alarm.	Scene 1 ... 64 Default value: 1

X = 1 to 3

The outputs respond according to the scene numbers and associated parameters.

*Note: This parameter is only visible if the **Position after alarm X** parameter has the following value: **Scene**.*

If several alarms triggered at the same time, the commands associated with the highest priority alarm are executed. The following parameters allow definition of this priority according to the alarm number.

Parameter	Description	Value
Priority between alarm 1 and 2	This parameter defines the priority between 2 alarm functions.	Alarm 1 > Alarm 2* Alarm 2 > Alarm 1

*Note: This parameter is only visible if the **Alarm** parameter has the following value: **2 alarm objects**.*

Parameter	Description	Value
Priority between alarm 1, 2 and 3	This parameter defines the priority between 3 alarm functions.	Alarm 1 > Alarm 2 > Alarm 3* Alarm 1 > Alarm 3 > Alarm 2 Alarm 2 > Alarm 1 > Alarm 3 Alarm 2 > Alarm 3 > Alarm 1 Alarm 3 > Alarm 1 > Alarm 2 Alarm 3 > Alarm 2 > Alarm 1

*Note: This parameter is only visible if the **Alarm** parameter has the following value: **3 alarm objects**.*

3.9.6.2 Alarm status indication

Parameter	Description	Value
Alarm status object	This parameter is used to authorize the Alarm status object. This object allows the status of the alarm to be sent from the device over the KNX bus.	Not active* Active

Communication objects: [22, 62, ... 382 - Outputs x-y - Alarm status object \(1 bit - 1.011 DPT_State\)](#)

Parameter	Description	Value
Polarity	The Alarm status object sends: 0 if no alarm is active. 1 if one of the three alarms is active. 1 if no alarm is active. 0 if one of the three alarms is active.	0 = Alarm deactivated, 1 = Alarm activated* 0 = Alarm activated, 1 = Alarm deactivated

Parameter	Description	Value
Emission	The Alarm status indication communication object is sent: On activation and deactivation of the alarm. Periodically after a configurable time. On activation and deactivation of the alarm and periodically after a configurable time.	On status change* Periodically On status change and periodically

*Note: This parameter is only visible if the **Alarm status object** parameter has the following value: **Active**.*

Parameter	Description	Value
Hours (h)	This parameter determines the time between the individual transmissions of the Status indication lock-up object.	0 hours: 0 to 23 h
Minutes (min)		30 minutes: 0 to 59 min
Seconds (s)		0 seconds: 0 to 59 s

Note: The smallest executable time is 1 second.

*Note: This parameter is only visible if the **Emission** parameter has the following value: **Periodically** or **On status change and periodically**.*

* Default value

3.9.6.3 Alarm monitoring period

Parameter	Description	Value
Alarm monitoring period	<p>The Alarm 1-3 objects</p> <p>Expect no periodic signal.</p> <p>Expect a periodic 0 signal.</p> <p>If this signal remains off, the super alarm is automatically activated the shutters/blinds are run to the position set by the Position on Alarm X parameter.</p>	<p>Not active*</p> <p>Active</p>

Parameter	Description	Value
Hours (h)	This parameter defines the maximum time between 2 signals on the Super alarm communication object.	0 hours: 0 to 23 h
Minutes (min)		15 minutes: 0 to 59 min
Seconds (s)		0 seconds: 0 to 59 s

Note: The smallest executable time is 1 second.

*Note: This parameter is only visible if the **Alarm monitoring period** parameter has the following value: **Active**.*

* Default value

3.9.7 Sun protection

Outputs 1-20: Function	Sun protection type	Objects position and slat angle
Outputs 1-20: General	Sun protection lock-up by local control	<input checked="" type="checkbox"/>
- O1-20: Manual mode ON/OFF	Lock-up on	Up/down and step/stop control
- O1-20: Status indications ON/OFF	Sun protection lock-up	<input type="radio"/> Time limited <input checked="" type="radio"/> Permanently
- O1-20: Status indications shutter		
Outputs 1-2	Sun protection authorization object	<input checked="" type="checkbox"/>
Outputs 1-2: Function selection	Polarity	<input checked="" type="radio"/> 0 = Locked-up , 1 = Authorized <input type="radio"/> 0 = Authorized, 1 = Locked-up
- O1-2: Sun protection	Value at initialization	0
+ Output 3	Position after sun protection	Maintain status
+ Output 4		
+ Output 5	Sun protection status object	<input checked="" type="checkbox"/>
+ Output 6	Polarity	<input checked="" type="radio"/> 0 = Locked-up , 1 = Authorized <input type="radio"/> 0 = Authorized, 1 = Locked-up
+ Output 7	Emission	On status change

General description of the sun protection controls:

Shade trim and slat adjustments

Using the shade trim control the Sun protection is not run all the way down but rather just so far down that only a configurable strip of sunshine (e.g. 50 cm) enters the room (e.g. 50 cm). In this way, users at the bottom of the window can see out and plants on the windowsill will receive sunshine.

Note: The shade trim adjustment is only usable with sun protection that runs from the top to the bottom (Such as shutters, textile sun protection or blinds with horizontal slats). This function is not usable for a sun protection that is pulled from one side to the other or pulled in front of a window from both sides.

During slat adjustment, the horizontal slats of the blinds are not fully closed; rather they are matched to the sun condition and set automatically in such a way that the sun cannot shine directly into the room.

However diffuse daylight can enter the room between the slats and so provide glare-free room lighting. Slat adjustment of an external blind prevents the entry of heat from sunshine into the room and, at the same time, reduces the cost of electricity for room lighting.

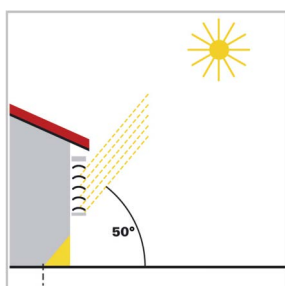

Sun protection at high sun elevations

The sun protection is only partially closed and automatically driven so far down that the sun can only shine into the room as far as the maximum permitted penetration depth. The slats can be made almost horizontal without the sun shining directly into the room.

Sun protection at medium sun elevations

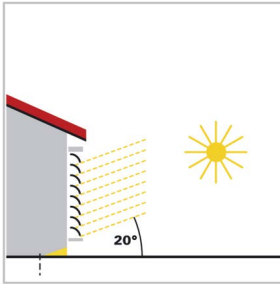

The sun protection will automatically be lowered so that the maximum penetration depth of sunshine into the room is not exceeded. The slats are automatically closed so far that the sun cannot shine directly into the room. Diffuse daylight, however, can still continue to enter and so provide lighting for the room (daylight use).

Sun protection at low sun elevations

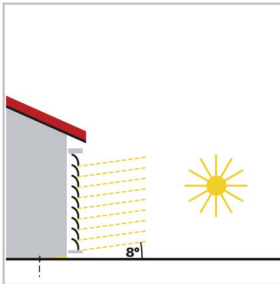

The sun protection is automatically lowered almost completely, so that the sun cannot shine too far into the room. The slats are automatically closed to an extent where the sun cannot shine directly into the room.

Parameter	Description	Value
Sun protection type	An external sun protection control sends the following commands for the positioning of the blinds: Positioning and slat adjustments. Positioning only. Slat adjustment only.	Objects position and slat angle* Position object only Slat angle object only

Note: These objects are only visible if the **Sun protection type** parameter has the following value: **Objects position and slat angle** or **Position object only**.

Communication objects: [23, 63, ... 383 - Outputs x-y - Sun protection position % \(1 byte - 5.001 DPT_Percentage\)](#)

Note: These objects are only visible if the **Sun protection type** parameter has the following value: **Objects position and slat angle** or **Slat angle object only**.

Communication objects: [24, 64, ... 384 - Outputs x-y - Sun protection slat angle % \(1 byte - 5.001 DPT_Percentage\)](#)

* Default value

Parameter	Description	Value
Sun protection lock-up by local control	<p>This parameter allows lock-up of the Sun protection position in % object and the sun protection slat position in % after operation of the shutter/blind with local KNX controls.</p> <p>When this function is activated, the Sun protection reactivation object is also displayed. This allows a reactivation of both sun protection objects.</p>	Not active* Active

Communication objects: [26, 66, ... 386 - Outputs x-y - Sun protection reactivation](#) (1 bit - 1.003 DPT_Enable)

Parameter	Description	Value
Lock-up on	<p>This parameter specifies on which local control commands the sun protection will lock up:</p> <p>Only after Up/Down (long key-press) commands.</p> <p>Only after slat step (short key-press) commands.</p> <p>After Up/Down and slat step command.</p> <p>After all basic commands.</p>	Up/down control Step/stop control Up/down and step/stop control* All basic controls

*Note: This parameter is only visible if the **Deactivate sun protection by local control** parameter has the following value: **Active**.*

Note: All basic commands means the commands with the lowest priority (Scenes, Preset, etc...)

Parameter	Description	Value
Sun protection lock-up	<p>This parameter defines whether the Sun protection function is permanently activated or time-limited.</p> <p>The lock-up is active until it receives a signal on the Sun protection reactivation object (depending on polarity).</p> <p>The lock-up is active for a configurable time. After expiry of which the sun protection objects are again processed.</p>	Permanently* Time limited

Parameter	Description	Value
Sun protection authorization object	With this parameter, the device's Sun protection authorization object can be activated or deactivated.	Not active* Active

* Default value

Communication objects: **25, 65, ... 385 - Outputs x-y - Sun protection authorization** (1 bit - 1.003 DPT_Enable)

Principle of the Sun protection authorization function

The parameters are set as follows:

Sun protection authorization: 0 = Locked-up, 1 = Authorized

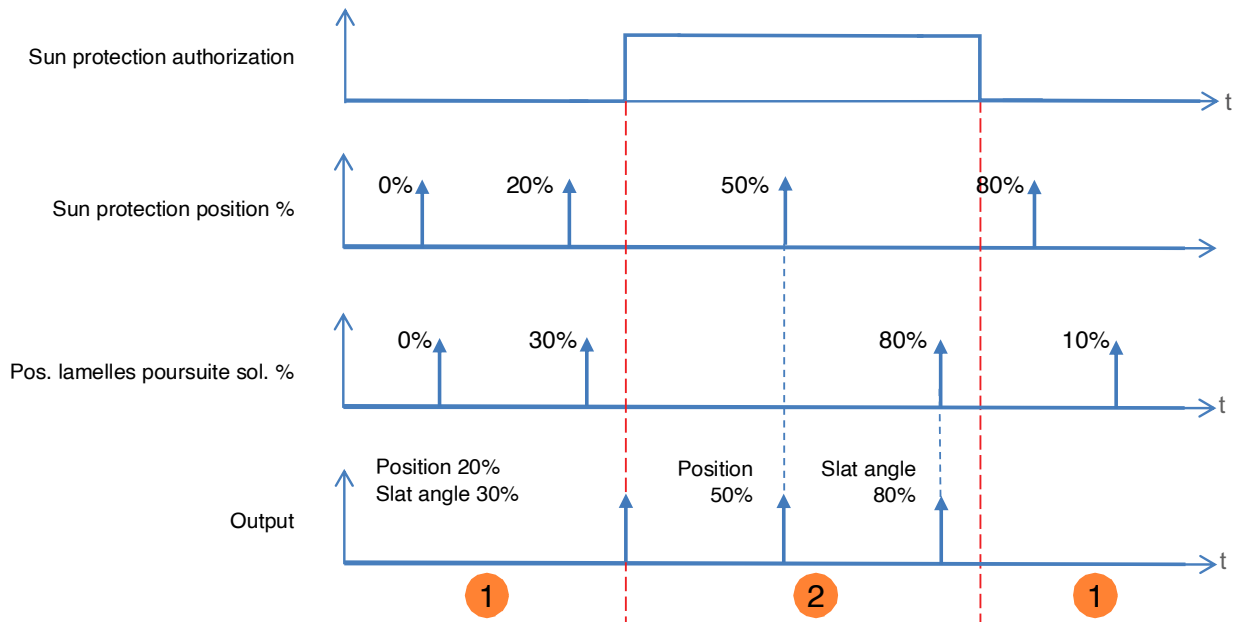

- 1 The Sun protection function has no effect on the output.
- 2 The commands from the sun protection functions are executed.

Note: The sun protection function commands will be executed immediately on authorization.

Parameter	Description	Value
Polarity	<p>This parameter defines how the device reacts on receipt of a telegram to the Sun protection authorization object:</p> <p>0 = Sun protection locked-up (OFF) 1 = Sun protection authorized (ON)</p> <p>0 = Sun protection authorized (ON) 1 = Sun protection locked-up (OFF)</p>	<p>0 = Locked-up, 1 = Authorized*</p> <p>0 = Authorized, 1 = Locked-up</p>

*Note: This parameter is only visible if the **Sun protection authorization object** parameter has the following value: **Active**.*

Parameter	Description	Value
Value at initialization	<p>On initialization of the device after a download or after return of the bus power, the value of the Sun protection authorization object is:</p> <p>Set to 0.</p> <p>Set to 1.</p> <p>Set according to the value that the object had before initialization.</p>	<p>0*</p> <p>1</p> <p>Value before initialization</p>

Parameter	Description	Value
Position after sun protection	<p>After lock-up of the sun protection due to a 0 on the Sun protection authorization object, the output is:</p> <p>Not changed.</p> <p>Closes the Up contact.</p> <p>Closes the down contact.</p> <p>Runs to a specific position.</p> <p>Runs to a position set in a scene.</p> <p>Run to the position before the priority.</p>	<p>Maintain status*</p> <p>Up</p> <p>Down</p> <p>Specific position</p> <p>Scene number</p> <p>Position before sun protection</p>

Parameter	Description	Value
Position (0-100%)	This parameter defines the position to run the shutter or blind to.	0* ... 100

*Note: This parameter is only visible if the **Position after sun protection** has the value **Specific position** and if the **Sun protection type** parameter has the value **Position and Slat position object** or **only position object**.*

Parameter	Description	Value
Slat angle (0-100%)	This parameter defines the slat position to use for the blind.	0* ... 100

*Note: This parameter is only visible if the **Position after sun protection** has the value **Specific position** and if the **Sun protection type** parameter has the value **Position and Slat position object** or **Position only object**.*

Parameter	Description	Value
Scene	This parameter defines the scene number that is to be activated after the sun protection.	Scene 1 ... 64 Default value: 1

The outputs respond according to the scene numbers and associated parameters.

*Note: This parameter is only visible if the **Position after sun protection** parameter has the following value: **Scene**.*

Parameter	Description	Value
Sun protection status object.	This parameter is used to authorize the Sun protection status object. This object allows the status of the sun protection to be sent from the device to the KNX bus.	Not active* Active

Communication objects: [27, 67, ... 387 - Outputs x-y - Sun protection status \(1 bit - 1.011 DPT_State\)](#)

Parameter	Description	Value
Polarity	This parameter defines the polarity of the Sun protection status : 0 = Sun protection locked-up 1 = Sun protection authorized 0 = Sun protection authorized 1 = Sun protection locked-up	0 = Locked-up, 1 = Authorized* 0 = Authorized, 1 = Locked-up

*Note: This parameter is only visible if the **Sun protection status object** parameter has the following value: **Active**.*

Parameter	Description	Value
Emission	The Sun protection status communication object is sent: On activation and deactivation of the lock-up. Periodically after a configurable time. On activation and deactivation of the lock-up and periodically after a configurable time.	On status change* Periodically On status change and periodically

*Note: This parameter is only visible if the **Sun protection status object** parameter has the following value: **Active**.*

Parameter	Description	Value
Hours (h)	This parameter determines the time between the individual transmissions of the Sun protection status objects.	0 hours: 0 to 23 h
Minutes (min)		30 minutes: 0 to 59 min
Seconds (s)		0 seconds: 0 to 59 s

Note: The smallest executable time is 1 second.

*Note: This parameter is only visible if the **Emission** parameter has the following value: **Periodically** or **On status change and periodically**.*

4. Communication objects

4.1 Communication objects General

The following table shows the list of available objects. It is applicable to the devices described in this document. Only the object numbers are different, depending on the number of outputs the device has.

	Number	Name	Object Function	Length	C	R	W	T
	401	Outputs 1-20: ON/OFF	Deactivation of manual mode	1 bit	C	R	W	-
	402	Outputs 1-20: ON/OFF	Status indication manual mode	1 bit	C	R	-	T
	403	Logic block 1 ON/OFF	Authorization	1 bit	C	R	W	-
	404	Logic block 1 ON/OFF	Input 1	1 bit	C	R	W	-
	405	Logic block 1 ON/OFF	Input 2	1 bit	C	R	W	-
	406	Logic block 1 ON/OFF	Input 3	1 bit	C	R	W	-
	407	Logic block 1 ON/OFF	Input 4	1 bit	C	R	W	-
	408	Logic block 1 ON/OFF	Logic result	1 bit	C	R	-	T
	409	Logic block 2 ON/OFF	Authorization	1 bit	C	R	W	-
	410	Logic block 2 ON/OFF	Input 1	1 bit	C	R	W	-
	411	Logic block 2 ON/OFF	Input 2	1 bit	C	R	W	-
	412	Logic block 2 ON/OFF	Input 3	1 bit	C	R	W	-
	413	Logic block 2 ON/OFF	Input 4	1 bit	C	R	W	-
	414	Logic block 2 ON/OFF	Logic result	1 bit	C	R	-	T
	415	Outputs 1-20: Shutter	Super alarm	1 bit	C	R	W	-
	416	Outputs 1-20: Shutter	Super alarm status	1 bit	C	R	-	T
	417	Outputs 1-20: Shutter	Deactivation of manual mode	1 bit	C	R	W	-
	418	Outputs 1-20: Shutter	Status indication manual mode	1 bit	C	R	-	T
	419	Logic block 1 shutter	Authorization	1 bit	C	R	W	-
	420	Logic block 1 shutter	Input 1	1 bit	C	R	W	-
	421	Logic block 1 shutter	Input 2	1 bit	C	R	W	-
	422	Logic block 1 shutter	Input 3	1 bit	C	R	W	-
	423	Logic block 1 shutter	Input 4	1 bit	C	R	W	-
	424	Logic block 1 shutter	Logic result	1 bit	C	R	-	T
	425	Logic block 2 shutter	Authorization	1 bit	C	R	W	-
	426	Logic block 2 shutter	Input 1	1 bit	C	R	W	-
	427	Logic block 2 shutter	Input 2	1 bit	C	R	W	-
	428	Logic block 2 shutter	Input 3	1 bit	C	R	W	-
	429	Logic block 2 shutter	Input 4	1 bit	C	R	W	-
	430	Logic block 2 shutter	Logic result	1 bit	C	R	-	T
	431	Outputs 1-20	Restore ETS-params settings	1 bit	C	R	W	-
	432	Outputs 1-20	Device LED switch off	1 bit	C	R	W	-
	433	Outputs 1-20	Diagnosis	6 byte	C	R	-	T

4.1.1 Manual mode

No.	Name	Object Function	Data type	Flags
401	Outputs 1-20: ON/OFF	Deactivation of manual mode	1 bit - 1.003 DPT_Enable	C, R, W
<p>This object is activated if the Manual mode parameter and the Deactivation of manual mode object are active. This object is used to control the manual mode via the KNX bus. Object value: Depends on the Polarity parameter.</p> <p>0 = Manual mode locked-up, 1 = Manual mode authorized:</p> <ul style="list-style-type: none"> - If the object receives the value 1, manual mode is activated. - If the object receives the value 0, manual mode is deactivated. <p>0 = Manual mode authorized, 1 = Manual mode locked-up:</p> <ul style="list-style-type: none"> - If the object receives the value 1, manual mode is deactivated. - If the object receives the value 0, manual mode is activated. <p>For further information, see: Manual mode: ON/OFF.</p>				

No.	Name	Object Function	Data type	Flags
417	Outputs 1-10: Shutter	Deactivation of manual mode	1 bit - 1.003 DPT_Enable	C, R, W
<p>See object No. 401</p> <p>For further information, see: Manual mode: Shutter.</p>				

No.	Name	Object Function	Data type	Flags
402	Outputs 1-10: ON/OFF	Status indication manual mode	1 bit - 1.011 DPT_State	C, R, T
<p>This object is activated if the Manual mode parameter and the Deactivation of manual mode object are active. This object is used to send the manual mode status of the device via the KNX bus. Object value: Depends on the Polarity parameter.</p> <p>0 = Manual mode activated, 1 = Manual mode deactivated:</p> <ul style="list-style-type: none"> - If manual mode is deactivated, a telegram is sent with logic value 1. - If manual mode is activated, a telegram is sent with logic value 0. <p>0 = Manual mode deactivated, 1 = Manual mode activated:</p> <ul style="list-style-type: none"> - If manual mode is activated, a telegram is sent with logic value 1. - If manual mode is deactivated, a telegram is sent with logic value 0. <p>This object is sent periodically and/or on status change. For further information, see: Manual mode: ON/OFF.</p>				

No.	Name	Object Function	Data type	Flags
418	Outputs 1-10: Shutter	Status indication manual mode	1 bit - 1.011 DPT_State	C, R, T
<p>See object No. 402</p> <p>For further information, see: Manual mode: Shutter.</p>				

4.1.2 Logic block

No.	Name	Object Function	Data type	Flags
403	Logic block 1 ON/OFF	Authorization	1 bit - 1.003 DPT_Enable	C, R, W

This object is activated if the **Logic block 1** parameter and the **Lock-up logic block** object are active. This object makes it possible to activate or deactivate the logic blocks of the device via the KNX bus. Object value: Depends on the **Polarity** parameter.

0 = Locked-up, 1 = Authorized:

- If the object receives the value 0, logic block 1 is deactivated.
- If the object receives the value 1, logic block 1 is activated.

0 = Authorized, 1 = Locked-up:

- If the object receives the value 0, logic block 1 is activated.
- If the object receives the value 1, logic block 1 is deactivated.

The value of this object can be initialized at start-up of the device.

For further information, see: [Logic block : ON/OFF](#).

No.	Name	Object Function	Data type	Flags
419	Logic block 1 shutter	Authorization	1 bit - 1.003 DPT_Enable	C, R, W

See object No. 403

For further information, see: [Logic block : Shutter](#).

No.	Name	Object Function	Data type	Flags
404	Logic block 1 ON/OFF	Input 1	1 bit - 1.002 DPT_Bool	C, R, W
405	Logic block 1 ON/OFF	Input 2	1 bit - 1.002 DPT_Bool	C, R, W
406	Logic block 1 ON/OFF	Input 3	1 bit - 1.002 DPT_Bool	C, R, W
407	Logic block 1 ON/OFF	Input 4	1 bit - 1.002 DPT_Bool	C, R, W

These objects are activated in accordance with the value of the **Number of logic inputs** parameter. There may be up to a maximum of 4 of these objects. These objects are used to produce the status of a logic input for processing of the logic operation. The value of these objects can be initialized at start-up of the device.

For further information, see: [Logic block : ON/OFF](#).

No.	Name	Object Function	Data type	Flags
420	Logic block 1 shutter	Input 1	1 bit - 1.002 DPT_Bool	C, R, W
421	Logic block 1 shutter	Input 2	1 bit - 1.002 DPT_Bool	C, R, W
422	Logic block 1 shutter	Input 3	1 bit - 1.002 DPT_Bool	C, R, W
423	Logic block 1 shutter	Input 4	1 bit - 1.002 DPT_Bool	C, R, W

See object No. 404

For further information, see: [Logic block : Shutter](#).

No.	Name	Object Function	Data type	Flags
408	Logic block 1 ON/OFF	Logic result	1 bit - 1.002 DPT_Bool	C, R, T
<p>This object is activated when the Logic block 1 parameter is active. This object enables output of the results of the logic operation via the bus. The value of the object is the result of a logic AND or OR operation, according to the status of the logic inputs. There may be up to a maximum of 4 of these objects. This result can also be directly assigned to the status of the output contact.</p> <p>For further information, see: Logic block : ON/OFF.</p>				

No.	Name	Object Function	Data type	Flags
424	Logic block 1 shutter	Logic result	1 bit - 1.002 DPT_Bool	C, R, T
<p>See object No. 408</p> <p>For further information, see: Logic block : Shutter.</p>				

No.	Name	Object Function	Data type	Flags
409	Logic block 2 ON/OFF	Authorization	1 bit - 1.003 DPT_Enable	C, R, W
<p>See object No. 403</p>				

No.	Name	Object Function	Data type	Flags
425	Logic block 2 shutter	Authorization	1 bit - 1.003 DPT_Enable	C, R, W
<p>See object No. 419</p>				

No.	Name	Object Function	Data type	Flags
410	Logic block 2 ON/OFF	Input 1	1 bit - 1.002 DPT_Bool	C, R, W
411	Logic block 2 ON/OFF	Input 2	1 bit - 1.002 DPT_Bool	C, R, W
412	Logic block 2 ON/OFF	Input 3	1 bit - 1.002 DPT_Bool	C, R, W
413	Logic block 2 ON/OFF	Input 4	1 bit - 1.002 DPT_Bool	C, R, W
<p>See object No. 404</p>				

No.	Name	Object Function	Data type	Flags
426	Logic block 2 shutter	Input 1	1 bit - 1.002 DPT_Bool	C, R, W
427	Logic block 2 shutter	Input 2	1 bit - 1.002 DPT_Bool	C, R, W
428	Logic block 2 shutter	Input 3	1 bit - 1.002 DPT_Bool	C, R, W
429	Logic block 2 shutter	Input 4	1 bit - 1.002 DPT_Bool	C, R, W
<p>See object No. 420</p>				

No.	Name	Object Function	Data type	Flags
414	Logic block 2 ON/OFF	Logic result	1 bit - 1.002 DPT_Bool	C, R, T
<p>See object No. 408</p>				

No.	Name	Object Function	Data type	Flags
430	Logic block 2 shutter	Logic result	1 bit - 1.002 DPT_Bool	C, R, T
<p>See object No. 424</p>				

4.1.3 Super alarm

No.	Name	Object Function	Data type	Flags
415	Outputs 1-20: Shutter	Super alarm	1 bit - 1.005 DPT_Alarm	C, R, W

This object is activated when the **Super alarm** parameter is active.
 This function is used to set all the outputs of the device into a configurable blocked state.
 If the object receives the value 1, all the outputs of the device are switched to a predefined status. All other functions, including manual mode, will be locked.
 The function can only be ended by receipt of a telegram with the value 0.
 For further information, see: [Super alarm](#).

No.	Name	Object Function	Data type	Flags
416	Outputs 1-20: Shutter	Super alarm status	1 bit - 1.011 DPT_State	C, R, T

This object is activated when the **Status indication super alarm** parameter is active.
 This object allows the status of the super alarm to be sent over the KNX bus.
 Object value: Depends on the **Polarity** parameter.

0 = activated, 1 = deactivated

- If the super alarm is deactivated, a telegram with logic value 1 is sent on the KNX bus.
- If the super alarm is activated, a telegram with logic value 0 is sent on the KNX bus.

0 = deactivated, 1 = activated

- If the super alarm is activated, a telegram with logic value 1 is sent on the KNX bus.
- If the super alarm is deactivated, a telegram with logic value 0 is sent on the KNX bus.

This object is sent periodically and/or on status change.
 For further information, see: [Super alarm](#).

4.1.4 Behaviour of the device

No.	Name	Object Function	Data type	Flags
431	Outputs 1-20	Restore ETS-params settings	1 bit - 1.015 DPT_Reset	C, R, W

This object is activated if the **Activ. of restore ETS-parameters object (scenes, timer, setpoints)** parameter is active.
 This object enables the current parameter value to be replaced at any time with the ETS parameter value.
 If the object receives value 1, then the output status values for the scenes, the timer duration specifications and all the counter setpoints are reset to the values sent by the last download.
 For further information, see: [Restore ETS-Parameters](#).

No.	Name	Object Function	Data type	Flags
432	Outputs 1-20	Device LED switch off	1 bit - 1.001 DPT_Switch	C, R, W

This object is activated if the **Device LEDS lock-up** object parameter is active.
 This function is used to reduce the overall power consumption of the device. It allows the LEDs on the front of the device to be switched off.
 Object value: Depends on the **Polarity** parameter.

0 = Status indication, 1 = Always OFF:

- If the object receives value 0, the LED display is activated.
- If the object receives value 1, the LED display is deactivated.

0 = Always OFF, 1 = Status indication:

- If the object receives value 0, the LED display is deactivated.
- If the object receives value 1, the LED display is activated.

For further information, see: [LED display](#).

4.1.5 Diagnosis

No.	Name	Object Function	Data type	Flags
433	Outputs 1-20	Diagnosis	6 byte - Specific	C, R, T

This object is activated when the **Device diagnosis object** parameter is active.
 The object enables reporting of current faults according to the device and the application used. It also allows sending of the position of the switch on the front of the device and the number of the output that is affected by the fault(s).

Byte number	6 (MSB)	5	4	3	2	1(LSB)
Use	Switch position	Application type	Output number	Error codes		

This object is sent periodically and/or on status change.

For further information, see: [Diagnosis](#).

4.2 Output communication objects

The following table shows the list of available objects for an output. It is also applicable to the other outputs of the different devices described in this document. Only the object numbers are different, depending on the number of outputs the device has.

	Number	Name	Object Function	Length	C	R	W	T
	1	Output 1	ON/OFF	1 bit	C	R	W	-
	2	Output 1	Timer/toggle switch changeover	1 bit	C	R	W	-
	3	Output 1	Time limited toggle switch	1 bit	C	R	W	-
	4	Output 1	Status indication ON/OFF	1 bit	C	R	-	T
	5	Output 1	Timer	1 bit	C	R	W	-
	6	Output 1	Timer duration	3 bytes	C	R	W	-
	7	Output 1	Scene	1 byte	C	R	W	-
	8	Output 1	Preset 1	1 bit	C	R	W	-
	9	Output 1	Preset 2	1 bit	C	R	W	-
	10	Output 1	Preset 1 authorization	1 bit	C	R	W	-
	11	Output 1	Preset 2 authorization	1 bit	C	R	W	-
	12	Output 1	Lock-up 1	1 bit	C	R	W	-
	13	Output 1	Lock-up 2	1 bit	C	R	W	-
	14	Output 1	Status indication lock-up	1 bit	C	R	-	T
	15	Output 1	Priority	2 bit	C	R	W	-
	16	Output 1	Status indication priority	1 bit	C	R	-	T
	17	Output 1	Hours counter value (h)	2 bytes	C	R	-	T
			Hours counter value (s)	4 bytes	C	R	-	T
	18	Output 1	Reset hours counter value	1 bit	C	R	W	-
	19	Output 1	Hours counter setpoint reached	1 bit	C	R	-	T
	20	Output 1	Hours counter setpoint (h)	2 bytes	C	R	W	-
			Hours counter setpoint (s)	4 bytes	C	R	W	-

4.2.1 ON/OFF

No.	Name	Object Function	Data type	Flags
1, 21, ... 381	Output x	ON/OFF	1 bit - 1.001 DPT_Switch	C, R, W
<p>These objects are always activated. They enable switching of the output contact in accordance with the value that is sent via the KNX bus.</p> <p>Object value: Object value: depends on the Output contact parameter.</p> <p>Normally open:</p> <ul style="list-style-type: none"> - On input of an OFF command, the output relay contact opens. - On input of an ON command, the output relay contact closes. <p>Normally closed:</p> <ul style="list-style-type: none"> - On input of an OFF command, the output relay contact closes. - On input of an ON command, the output relay contact opens. <p>For further information, see: Function selection.</p>				

4.2.2 ON/OFF timings function

No.	Name	Object Function	Data type	Flags
2, 22, ... 382	Output x	Timer/toggle switch changeover	1 bit - 1.001 DPT_Switch	C, R, W

This object is activated if the **Timer/toggle switch changeover for ON/OFF** object parameter is active.
 This object is used to switch between a toggle switch and timer switch operation on the same pushbutton.

- If the **Timer/toggle switch changeover** object receives the value 1, the Toggle-switch mode function is activated. The ON/OFF switching of the output is performed as usual via the **ON/OFF** object.
- If the **Timer/toggle switch changeover** object receives the value 0, the Timer mode function is activated.
 - If the **ON/OFF** object receives the value 1, the output is switched ON. After expiry of a configurable time, the output is automatically switched OFF.
 - If the **ON/OFF** object receives the value 0, the output is switched OFF.

*Example: Switching function daytime and Time-limited OFF function at night.
 During the day, the button is used as a switch. In the evenings, the button is used as a time-limited OFF switch, so that the light will turn off automatically.*

For further information, see: [ON/OFF timings function](#).

No.	Name	Object Function	Data type	Flags
3, 23, ... 383	Output x	Time limited toggle switch	1 bit - 1.001 DPT_Switch	C, R, W

This object is activated when the **Additional time limited toggle switch function** parameter is active.
 This object combines a timer function with a tripping Delay function.

- If the object receives the value 1, the output switches to ON for a configurable time period. After that period expires, the output switches to OFF.
- If the object receives the value 0, the output switches to OFF.

Note: The time-limited OFF function is generally used for lighting in cellars, attics and sheds.

For further information, see: [ON/OFF timings function](#).

4.2.3 Status indication

No.	Name	Object Function	Data type	Flags
4, 24, ... 384	Output x	Status indication ON/OFF	1 bit - 1.001 DPT_Switch	C, R, T
<p>This object is activated when the Status indication ON/OFF parameter is active. This object allows the status of the output contact to be sent from the device over the KNX bus. Object value: Depends on the Polarity parameter.</p> <p>0 = ON, 1 = OFF</p> <ul style="list-style-type: none"> - If the output relay is open, a telegram with logic value 1 is sent on the KNX bus. - If the output relay is closed, a telegram with logic value 0 is sent on the KNX bus. <p>0 = OFF, 1 = ON</p> <ul style="list-style-type: none"> - If the output relay is open, a telegram with logic value 0 is sent on the KNX bus. - If the output relay is closed, a telegram with logic value 1 is sent on the KNX bus. <p>This object is sent periodically and/or on status change.</p> <p>For further information, see: Status indication.</p>				

4.2.4 Timer

No.	Name	Object Function	Data type	Flags
5, 25, ... 385	Output x	Timer	1 bit - 1.010 DPT_Start/stop	C, R, W
<p>This object is activated when the Timer parameter is active. This object is used to activate the Timer function of the device via the KNX bus. Object value:</p> <ul style="list-style-type: none"> - If a rising edge (0 to 1) arrives at this object, the output switches for a configurable period. - If a falling edge (1 to 0) arrives at this object, the output remains in its current state. <p><i>Note: Depending on the configuration, the timer switching can be interrupted on the timer by a long press of the control button.</i> <i>Note: Depending on the configuration, the timer duration may be reset by input of a start command during timer operation.</i></p> <p>For further information, see: Timer.</p>				

No.	Name	Object Function	Data type	Flags
6, 26, ... 386	Output x	Timer duration	3 bytes - 10.001 DPT_TimeOfDay	C, R, W

This object is activated if the **Timer duration modifiable through object** object parameter is active.
 This object can be used to configure the timer duration. The timer duration can thus be configured in accordance with a time of day.

Byte 3 (MSB)						Byte 2						Byte 1 (LSB)						
			Hours						Minutes						Seconds			
0	0	0	H	H	H	0	0	M	M	M	M	M	M	0	0	S	S	S

Fields	Code	Value	Units
Hours	Binary	0 to 23 (5 bit)	Hours
Minutes	Binary	0 to 59 (6 bit)	Minutes
Seconds	Binary	0 to 59 (6 bit)	Seconds

For further information, see: [Timer](#).

4.2.5 Scene

No.	Name	Object Function	Data type	Flags
7, 27, ... 387	Output x	Scene	1 byte - 18.001 DPT_SceneControl	C, R, W

This object is activated when the **Scene** parameter is active.
 This object is used to recall or save a scene.
 Details on the format of the object are given below.

7	6	5	4	3	2	1	0
Learning	Not used	Scene number					

Bit 7: 0: The scene is called / 1: The scene is saved.
 Bit 6: Not used.
 Bit 5 to Bit 0: Scene numbers from 0 (Scene 1) to 63 (Scene 64).

For further information, see: [Scene](#).

4.2.6 Preset

No.	Name	Object Function	Data type	Flags
8, 28, ... 388	Output x	Preset 1	1 bit - 1.022 DPT_Scene	C, R, W
<p>This object is activated if the Preset has value Active with preset 1-level object or Active with preset 2-level objects. With this object, several outputs can be set to a configurable predefined status. Object value: - If the object receives value 0, the values of the parameters for Preset 1 = 0 are used. - If the object receives value 1, the values of the parameters for Preset 1 = 1 are used.</p> <p>For further information, see: Preset ON/OFF.</p>				

No.	Name	Object Function	Data type	Flags
9, 29, ... 389	Output x	Preset 2	1 bit - 1.022 DPT_Scene	C, R, W
<p>This object is activated if the Preset parameter has value Active with preset 2-level objects.</p> <p>See object No. 7</p>				

No.	Name	Object Function	Data type	Flags
10, 30, ... 390	Output x	Preset 1 authorization	1 bit - 1.003 DPT_Enable	C, R, W
<p>This object is activated if the Preset authorization objects parameter is active. This object allows the authorization or lock-up of the Preset 1 function via a KNX telegram. Object value: This is dependent on the Polarity of autorisation object Preset 1 parameter. 0 = Locked-up, 1 = Authorized: - If the object receives the value 0, Preset 1 is deactivated. - If the object receives the value 1, Preset 1 is activated.</p> <p>0 = Authorized, 1 = Locked-up: - If the object receives the value 0, Preset 1 is activated. - If the object receives the value 1, Preset 1 is deactivated.</p> <p>For further information, see: Preset ON/OFF.</p>				

No.	Name	Object Function	Data type	Flags
11, 31, ... 391	Output x	Preset 2 authorization	1 bit - 1.003 DPT_Enable	C, R, W
<p>See object No. 10</p>				

4.2.7 Lock-up

No.	Name	Object Function	Data type	Flags
12, 32, ... 392	Output x	Lock-up 1	1 bit - 1.003 DPT_Enable	C, R, W
<p>This object is activated if the Lock-up has value Active with 1 lock-up object or Active with 2 lock-up objects. This object is used to control the activation of the lock-up via the KNX bus. Object value: This is dependent on the Polarity of lock-up object 1 parameter. 0 = Lock-up activated, 1 = Lock-up deactivated:</p> <ul style="list-style-type: none"> - If the object receives value 0, the Lock-up is activated. - If the object receives value 1, the Lock-up is deactivated. <p>0 = Lock-up deactivated, 1 = Lock-up activated:</p> <ul style="list-style-type: none"> - If the object receives value 0, the Lock-up is deactivated. - If the object receives value 1, the Lock-up is activated. <p>For further information, see: Lock-up ON/OFF.</p>				

No.	Name	Object Function	Data type	Flags
13, 33, ... 393	Output x	Lock-up 2	1 bit - 1.003 DPT_Enable	C, R, W
<p>This object is activated if the Lock-up parameter has value Active with 2 lock-up objects.</p> <p>See object No. 12.</p>				

No.	Name	Object Function	Data type	Flags
14, 34, ... 394	Output x	Status indication lock-up	1 bit - 1.011 DPT_State	C, R, T
<p>This object is activated when the Activation of lock-up status object parameter is active. This object allows the status of the lock-up to be sent from the device over the KNX bus. Object value: Depends on the Polarity parameter. 0 = Lock-up deactivated, 1 = Lock-up activated:</p> <ul style="list-style-type: none"> - If the lock-up is deactivated, a telegram with logic value 0 is sent on the KNX bus. - If the lock-up is activated, a telegram with logic value 1 is sent on the KNX bus. <p>0 = Lock-up activated, 1 = Lock-up deactivated:</p> <ul style="list-style-type: none"> - If the lock-up is activated, a telegram with logic value 0 is sent on the KNX bus. - If the lock-up is deactivated, a telegram with logic value 1 is sent on the KNX bus. <p>This object is sent periodically and/or on status change. For further information, see: Lock-up ON/OFF.</p>				

4.2.8 Priority

No.	Name	Object Function	Data type	Flags
15, 35, ... 395	Output x	Priority	2 bit - 2.002 DPT_Bool_Control	C, R, W

This object is activated if the **Priority** parameter is active.
 The status of the output contact is determined directly by this object.
 Details on the format of the object are given below.

Telegram received by the priority operation object		Status of the outputs
Bit 1	Bit 2	
0	0	End of the priority
0	1	End of the priority
1	0	Priority OFF
1	1	Priority ON

The first bit of this object (Bit 0) determines the status of the output contact, which should be priority controlled. The second bit activates or deactivates the Priority.

For further information, see: [Priority ON/OFF](#).

No.	Name	Object Function	Data type	Flags
16, 36, ... 396	Output x	Status indication priority	1 bit - 1.011 DPT_State	C, R, T

This object is activated if the **Activation of priority status object** parameter is active.
 This object allows the status of the Priority to be sent from the device on the KNX bus.
 Object value: Depends on the **Polarity** parameter.

0 = Not forced, 1 = Forced:

- If Priority is deactivated, a telegram is sent with logic value 0.
- If Priority is activated, a telegram is sent with logic value 1.

0 = Forced, 1 = Not forced:

- If Priority is activated, a telegram is sent with logic value 0.
- If Priority is deactivated, a telegram is sent with logic value 1.

This object is sent periodically and/or on status change.

For further information, see: [Priority ON/OFF](#).

4.2.9 Hours counter

No.	Name	Object Function	Data type	Flags
17, 37, ... 397	Output x	Hours counter value (h)	2 bytes - 7.007 DPT_Time(h)	C, R, T
		Hours counter value (s)	4 bytes - 13.100 DPT_Time lag(s)	C, R, T

This object is activated when the **Hours counter** parameter is active.
This object allows the value of the operating hours to be sent from the device on the KNX bus.
The count value is saved during a power cut on the KNX bus. It is submitted after return of power to the bus or after an ETS download.
Object value: 0 to 65535 hours (2-byte format) or 0 to 2147483647 seconds (4-byte format).

This object is sent periodically and/or on status change.
For further information, see: [Hours counter](#).

No.	Name	Object Function	Data type	Flags
18, 38, ... 398	Output x	Reset hours counter value	1 bit - 1.015 DPT_Reset	C, R, W

This object is activated when the **Hours counter** parameter is active.
This object enables the hours counter value to be reset.
Object value:

- If the object receives the value 0, the counter is not reset.
- If the object receives the value 1, the counter is reset.

For further information, see: [Hours counter](#).

No.	Name	Object Function	Data type	Flags
19, 39, ... 399	Output x	Hours counter setpoint reached	1 bit - 1.011 DPT_State	C, R, T

This object is activated when the **Hours counter** parameter is active.
This object reports that the hours counter has reached its setpoint.

- Incrementing counter: Counter = Counter value setpoint.
- Countdown counter: Counter = 0.

Object value: If the setpoint is reached, a telegram with logic value 1 is sent on the KNX bus.
The count value is saved during a power cut on the KNX bus. It is submitted after return of power to the bus or after an ETS download.

This object is sent periodically and/or on status change.
For further information, see: [Hours counter](#).

No.	Name	Object Function	Data type	Flags
20, 40, ... 400	Output x	Hours counter setpoint (h)	2 bytes - 7.007 DPT_Time(h)	C, R, W
		Hours counter setpoint (s)	4 bytes - 13.100 DPT_Time lag(s)	C, R, W

This object is activated if the **Counter setpoint value modifiable through object** object parameter is active. This object is used to initialize the counter setpoint of the hours counter via the KNX bus.
Object value: 0 to 65535 hours (2-byte format) or 0 to 2147483647 seconds (4-byte format).

This object is sent periodically and/or on status change.
For further information, see: [Hours counter](#).

4.3 Communication objects for each shutter/blind output

The following table shows the list of available objects for an output. It is also applicable to the other outputs of the different devices described in this document. Only the object numbers are different, depending on the number of outputs the device has.

	Number	Name	Object Function	Length	C	R	W	T
	1	Outputs 1-2	Up/Down (long key-press)	1 bit	C	R	W	-
	2	Outputs 1-2	Step/stop (short press)	1 bit	C	R	W	-
	3	Outputs 1-2	Position in %	1 byte	C	R	W	-
	4	Outputs 1-2	Slat angle (0-100%)	1 byte	C	R	W	-
	5	Outputs 1-2	Position indication in %	1 byte	C	R	-	T
	6	Outputs 1-2	Slat angle indication in %	1 byte	C	R	-	T
	7	Outputs 1-2	Upper position reached	1 bit	C	R	-	T
	8	Outputs 1-2	Lower position reached	1 bit	C	R	-	T
	9	Outputs 1-2	Scene	1 byte	C	R	W	-
	10	Outputs 1-2	Preset 1	1 bit	C	R	W	-
	11	Outputs 1-2	Preset 2	1 bit	C	R	W	-
	12	Outputs 1-2	Preset 1 authorization	1 bit	C	R	W	-
	13	Outputs 1-2	Preset 2 authorization	1 bit	C	R	W	-
	14	Outputs 1-2	Lock-up 1	1 bit	C	R	W	-
	15	Outputs 1-2	Lock-up 2	1 bit	C	R	W	-
	16	Outputs 1-2	Status indication lock-up	1 bit	C	R	-	T
	17	Outputs 1-2	Priority	2 bit	C	R	W	-
	18	Outputs 1-2	Status indication priority	1 bit	C	R	-	T
	19	Outputs 1-2	Alarm 1	1 bit	C	R	W	-
	20	Outputs 1-2	Alarm 2	1 bit	C	R	W	-
	21	Outputs 1-2	Alarm 3	1 bit	C	R	W	-
	22	Outputs 1-2	Alarm status object	1 bit	C	R	-	T
	23	Outputs 1-2	Sun protection position %	1 byte	C	R	W	-
	24	Outputs 1-2	Sun protection slat angle %	1 byte	C	R	W	-
	25	Outputs 1-2	Sun protection authorization	1 bit	C	R	W	-
	26	Outputs 1-2	Sun protection reactivation	1 bit	C	R	W	-
	27	Outputs 1-2	Sun protection status	1 bit	C	R	-	T

4.3.1 Control

No.	Name	Object Function	Data type	Flags
-----	------	-----------------	-----------	-------

No.	Name	Object Function	Data type	Flags
1, 41, ... 361	Output x-y	Up/Down (long key-press)	1 bit - 1.008 DPT_UpDown	C, R, W

These objects are always activated. It is used to control the shutter or blind in connection with the value that is sent on the KNX bus.

Object value:

- If the object receives value 0, the shutter or blind moves to the upper position.
- If the object receives value 1, the shutter or blind moves to the lower position.

For further information, see: [Functions for each shutter/blind output.](#)

No.	Name	Object Function	Data type	Flags
2, 42, ... 362	Output x-y	Step/stop (short press)	1 bit - 1.007 DPT_Step	C, R, W

These objects are always activated. It is used to stop the movement of the shutter or blind or the tilting of the slats according to the value that is sent on the KNX bus.

Object value:

- Regardless of which value (0 or 1) is sent to this object, the movement of the shutter or blind will be stopped.
- If the object receives the value 0, the slats will be opened by one slat step.
- If the object receives the value 1, the slats will be closed by one slat step.

For further information, see: [Function selection.](#)

No.	Name	Object Function	Data type	Flags
3, 43, ... 363	Output x-y	Position in %	1 byte - 5.001 DPT_Percentage	C, R, W

These objects are always activated. It is used for positioning the shutter or blind at the desired height, in response to the value sent on the KNX bus.

On the blind, the slats have the same tilt after reaching the same position as they had before the movement.

If a telegram is received during the movement of the shutter or blind, the shutter will be positioned at the desired height after the originally requested position has been reached.

Object value: 0 to 255

- 0 (0%): Upper position
- 255 (100%): Lower position

For further information, see: [Function selection.](#)

No.	Name	Object Function	Data type	Flags
4, 44, ... 364	Output x-y	Slat angle (0-100%)	1 byte - 5.001 DPT_Percentage	C, R, W

These objects are always activated. It is used to position the shutter or blind in response to the value that is sent on the KNX bus.

Object value: 0 to 255

- 0 (0%): Slats open
- 255 (100%): Slats closed

For further information, see: [Function selection.](#)

4.3.2 Status indication

No.	Name	Object Function	Data type	Flags
5, 45, ... 365	Output x-y	Position indication in %	1 byte - 5.001 DPT_Percentage	C, R, T
<p>This object is activated when the Status indication position in % parameter is active. This object allows the status of the position to be sent over the KNX bus. It is sent after the position of the blind or shutter has been achieved.</p> <p>Object value: 0 to 255</p> <ul style="list-style-type: none"> - 0 (0%): Upper position - 255 (100%): Lower position <p>This object is sent periodically and/or on status change. For further information, see: Status indication Shutter.</p>				

No.	Name	Object Function	Data type	Flags
6, 46, ... 366	Output x-y	Slat angle indication in %	1 byte - 5.001 DPT_Percentage	C, R, T
<p>This object is activated when the Status indication slat angle in % parameter is active. This object allows the status of the slat angle to be sent over the KNX bus. It is sent after the tilting of the blind has been achieved.</p> <p>Object value: 0 to 255</p> <ul style="list-style-type: none"> - 0 (0%): Slats open - 255 (100%): Slats closed <p>This object is sent periodically and/or on status change. For further information, see: Status indication Shutter.</p>				

No.	Name	Object Function	Data type	Flags
7, 47, ... 367	Output x-y	Upper position reached	1 bit - 1.002 DPT_Bool	C, R, T
<p>This object is activated when the Upper position reached objects parameter is active. This object is used to send the status of the upper position of the shutter or blind over the KNX bus. Object value: Depends on the Polarity parameter.</p> <p>0 = Position not reached, 1 = Position reached</p> <ul style="list-style-type: none"> - If the upper position of the shutter or blind is not reached, a telegram is sent with a logic value of 0 on the KNX bus. - If the upper position of the shutter or blind is reached, a telegram is sent with a logic value of 1 on the KNX bus. <p>0 = Position reached, 1 = Position not reached</p> <ul style="list-style-type: none"> - If the upper position of the shutter or blind is reached, a telegram is sent with a logic value of 0 on the KNX bus. - If the upper position of the shutter or blind is not reached, a telegram is sent with a logic value of 1 on the KNX bus <p>This object is sent periodically and/or on status change. For further information, see: Status indication Shutter.</p>				

No.	Name	Object Function	Data type	Flags
8, 48, ... 368	Output x-y	Lower position reached	1 bit - 1.002 DPT_Bool	C, R, T
<p>This object is activated if the Lower position reached objects parameter is active. This object is used to send the status of the lower position of the shutter or blind over the KNX bus. Object value: Depends on the Polarity parameter.</p> <p>0 = Position not reached, 1 = Position reached</p> <ul style="list-style-type: none"> - If the lower position of the shutter or blind is not reached, a telegram is sent with a logic value of 0 on the KNX bus. - If the lower position of the shutter or blind is reached, a telegram is sent with a logic value of 1 on the KNX bus. <p>0 = Position reached, 1 = Position not reached</p> <ul style="list-style-type: none"> - If the lower position of the shutter or blind is reached, a telegram is sent with a logic value of 0 on the KNX bus. - If the lower position of the shutter or blind is not reached, a telegram is sent with a logic value of 1 on the KNX bus <p>This object is sent periodically and/or on status change. For further information, see: Status indication Shutter.</p>				

4.3.3 Scene

No.	Name	Object Function	Data type	Flags
9, 49, ... 369	Output x-y	Scene	1 byte - 18.001 DPT_SceneControl	C, R, W

This object is activated when the **Scene** parameter is active.
 This object is used to recall or save a scene.
 Details on the format of the object are given below.

7	6	5	4	3	2	1	0
Learning	Not used	Scene number					

Bit 7: 0: The scene is called / 1: The scene is saved.
 Bit 6: Not used.
 Bit 5 to Bit 0: Scene numbers from 0 (Scene 1) to 63 (Scene 64).

For further information, see: [Scene Shutter](#).

4.3.4 Preset

No.	Name	Object Function	Data type	Flags
10, 50, ... 370	Output x-y	Preset 1	1 bit - 1.022 DPT_Scene	C, R, W

This object is activated if the **Preset** has value **Active with preset 1-level object** or **Active with preset 2-level objects**.
 With this object, several outputs can be set to a configurable predefined status.

Object value:

- If the object receives value 0, the values of the parameters for Preset 1 = 0 are used.
- If the object receives value 1, the values of the parameters for Preset 1 = 1 are used.

For further information, see: [Preset Shutter](#).

No.	Name	Object Function	Data type	Flags
11, 51, ... 371	Output x-y	Preset 2	1 bit - 1.022 DPT_Scene	C, R, W

This object is activated if the **Preset** parameter has value **Active with preset 2-level objects**.

See object No. 9

No.	Name	Object Function	Data type	Flags
12, 52, ... 372	Output x-y	Preset 1 authorization	1 bit - 1.003 DPT_Enable	C, R, W

This object is activated if the **Preset authorization objects** parameter is active.
 This object allows the authorization or lock-up of the Preset 1 function via a KNX telegram.
 Object value: This is dependent on the **Polarity of autorisation object Preset 1** parameter.

0 = Locked-up, 1 = Authorized:

- If the object receives the value 0, Preset 1 is deactivated.
- If the object receives the value 1, Preset 1 is activated.

0 = Authorized, 1 = Locked-up:

- If the object receives the value 0, Preset 1 is activated.
- If the object receives the value 1, Preset 1 is deactivated.

For further information, see: [Preset Shutter](#).

No.	Name	Object Function	Data type	Flags
13, 53, ... 373	Output x-y	Preset 2 authorization	1 bit - 1.003 DPT_Enable	C, R, W

See object No. 11

4.3.5 Lock-up

No.	Name	Object Function	Data type	Flags
14, 54, ... 374	Output x	Lock-up 1	1 bit - 1.003 DPT_Enable	C, R, W

This object is activated if the **Lock-up** has value **Active with 1 lock-up object** or **Active with 2 lock-up objects**.
 This object is used to control the activation of the lock-up via the KNX bus.
 Object value: This is dependent on the **Polarity of lock-up object 1** parameter.

0 = Lock-up activated, 1 = Lock-up deactivated:

- If the object receives value 0, the Lock-up is activated.
- If the object receives value 1, the Lock-up is deactivated.

0 = Lock-up deactivated, 1 = Lock-up activated:

- If the object receives value 0, the Lock-up is deactivated.
- If the object receives value 1, the Lock-up is activated.

For further information, see: [Lock-up Shutter](#).

No.	Name	Object Function	Data type	Flags
15, 55, ... 375	Output x	Lock-up 2	1 bit - 1.003 DPT_Enable	C, R, W

This object is activated if the **Lock-up** parameter has value **Active with 2 lock-up objects**.

See object No. 13.

No.	Name	Object Function	Data type	Flags
16, 56, ... 376	Output x-y	Status indication lock-up	1 bit - 1.011 DPT_State	C, R, T
<p>This object is activated when the Activation of lock-up status object parameter is active. This object allows the status of the lock-up to be sent from the device over the KNX bus. Object value: Depends on the Polarity parameter.</p> <p>0 = Lock-up deactivated, 1 = Lock-up activated:</p> <ul style="list-style-type: none"> - If the lock-up is deactivated, a telegram with logic value 0 is sent on the KNX bus. - If the lock-up is activated, a telegram with logic value 1 is sent on the KNX bus. <p>0 = Lock-up activated, 1 = Lock-up deactivated:</p> <ul style="list-style-type: none"> - If the lock-up is activated, a telegram with logic value 0 is sent on the KNX bus. - If the lock-up is deactivated, a telegram with logic value 1 is sent on the KNX bus. <p>This object is sent periodically and/or on status change. For further information, see: Lock-up Shutter.</p>				

4.3.6 Priority

No.	Name	Object Function	Data type	Flags																	
17, 57, ... 377	Output x-y	Priority	2 bit - 2.002 DPT_Bool_Control	C, R, W																	
<p>This object is activated if the Priority parameter is active. The status of the output contact is determined directly by this object. Details on the format of the object are given below.</p> <table border="1" data-bbox="142 1037 858 1339"> <thead> <tr> <th colspan="2">Telegram received by the priority operation object</th> <th rowspan="2">Status of the outputs</th> </tr> <tr> <th>Bit 1</th> <th>Bit 2</th> </tr> </thead> <tbody> <tr> <td>0</td> <td>0</td> <td>End of the priority</td> </tr> <tr> <td>0</td> <td>1</td> <td>End of the priority</td> </tr> <tr> <td>1</td> <td>0</td> <td>Priority OFF</td> </tr> <tr> <td>1</td> <td>1</td> <td>Priority ON</td> </tr> </tbody> </table> <p>The first bit of this object (Bit 0) determines the status of the output contact, which should be priority controlled. The second bit activates or deactivates the Priority.</p> <p>For further information, see: Priority Shutter.</p>					Telegram received by the priority operation object		Status of the outputs	Bit 1	Bit 2	0	0	End of the priority	0	1	End of the priority	1	0	Priority OFF	1	1	Priority ON
Telegram received by the priority operation object		Status of the outputs																			
Bit 1	Bit 2																				
0	0	End of the priority																			
0	1	End of the priority																			
1	0	Priority OFF																			
1	1	Priority ON																			

No.	Name	Object Function	Data type	Flags
18, 58, ... 378	Output x-y	Status indication priority	1 bit - 1.011 DPT_State	C, R, T
<p>This object is activated if the Activation of priority status object parameter is active. This object allows the status of the Priority to be sent from the device on the KNX bus. Object value: Depends on the Polarity parameter.</p> <p>0 = Not forced, 1 = Forced:</p> <ul style="list-style-type: none"> - If Priority is deactivated, a telegram is sent with logic value 0. - If Priority is activated, a telegram is sent with logic value 1. <p>0 = Forced, 1 = Not forced:</p> <ul style="list-style-type: none"> - If Priority is activated, a telegram is sent with logic value 0. - If Priority is deactivated, a telegram is sent with logic value 1. <p>This object is sent periodically and/or on status change. For further information, see: Priority Shutter.</p>				

4.3.7 Alarm

No.	Name	Object Function	Data type	Flags
19, 59, ... 379	Output x-y	Alarm 1	1 bit - 1.005 DPT_Alarm	C, R, W
<p>This object is only visible if the Alarm parameter has the following value: 1 alarm object or 2 alarm objects or 3 alarm objects. This object is used to switch the output back to the predefined settings.</p> <p>Object value:</p> <ul style="list-style-type: none"> - If the object receives the value 0, the alarm is not activated. - -If the object receives the value 1, the alarm is activated. <p>For further information, see: Alarm.</p>				

No.	Name	Object Function	Data type	Flags
20, 60, ... 380	Output x-y	Alarm 2	1 bit - 1.005 DPT_Alarm	C, R, W
See object No. 18.				

No.	Name	Object Function	Data type	Flags
21, 61, ... 381	Output x-y	Alarm 3	1 bit - 1.005 DPT_Alarm	C, R, W
See object No. 18.				

No.	Name	Object Function	Data type	Flags
22, 62, ... 382	Output x-y	Alarm status object	1 bit - 1.011 DPT_State	C, R, T
<p>This object is activated when the Alarm status object parameter is active. This object allows the status of the alarm angle to be sent over the KNX bus. Object value: Depends on the Polarity parameter.</p> <p>0 = Alarm deactivated, 1 = Alarm activated</p> <ul style="list-style-type: none"> - If all the alarms are deactivated, a telegram with logic value 0 is sent on the KNX bus. - If one of the three alarms is activated, a telegram with logic value 1 is sent on the KNX bus. <p>0 = Alarm activated, 1 = Alarm deactivated</p> <ul style="list-style-type: none"> - If one of the three alarms is activated, a telegram with logic value 0 is sent on the KNX bus. - If all the alarms are deactivated, a telegram with logic value 1 is sent on the KNX bus. <p>This object is sent periodically and/or on status change. For further information, see: Alarm.</p>				

4.3.8 Sun protection

No.	Name	Object Function	Data type	Flags
23, 63, ... 383	Output x-y	Sun protection position %	1 byte - 5.001 DPT_Percentage	C, R, W
<p>This object is only visible if the Sun protection type parameter has the following value: Objects position and slat angle or Position object only. It is used for positioning the shutter or blind at the desired height, in response to the value sent on the KNX bus. As a general rule, this object is connected with an external device, which sends a position value to the shutter or blind in response to the elevation of the sun.</p> <p>Object value: 0 to 255</p> <ul style="list-style-type: none"> - 0 (0%): Upper position - 255 (100%): Lower position <p>For further information, see: Sun protection.</p>				

No.	Name	Object Function	Data type	Flags
24, 64, ... 384	Output x-y	Sun protection slat angle %	1 byte - 5.001 DPT_Percentage	C, R, W
<p>This object is only visible if the Sun protection type parameter has the following value: Objects position and slat angle or Slat angle object only. This object is used to position the shutter or blind in response to the value that is sent on the KNX bus. As a general rule, this object is connected with an external device, which sends a slat angle value to the blind in response to the elevation of the sun.</p> <p>Object value: 0 to 255</p> <ul style="list-style-type: none"> - 0 (0%): Slats open - 255 (100%): Slats closed <p>For further information, see: Sun protection.</p>				

No.	Name	Object Function	Data type	Flags
25, 65, ... 385	Output x-y	Sun protection authorization	1 bit - 1.003 DPT_Enable	C, R, W
<p>This object is activated if the Sun protection authorization object parameter is active. This object allows the sun protection status of the alarm function of the device to be activated or deactivated over the KNX bus. Object value: Depends on the Polarity parameter.</p> <p>0 = Locked-up, 1 = Authorized</p> <ul style="list-style-type: none"> - If the object receives the value 0, the sun protection is deactivated. - If the object receives the value 1, the sun protection is activated. <p>0 = Authorized, 1 = Locked-up</p> <ul style="list-style-type: none"> - If the object receives the value 0, the sun protection is activated. - If the object receives the value 1, the sun protection is deactivated. <p>For further information, see: Sun protection.</p>				

No.	Name	Object Function	Data type	Flags
26, 66, ... 386	Output x-y	Sun protection reactivation	1 bit - 1.003 DPT_Enable	C, R, W
<p>This object is activated if the Deactivate sun protection by local control parameter is active. This object is used to reactivate the sun protection of the device after a lock-up or at the end of a time-limited function, over the KNX Bus.</p> <p>Object value:</p> <ul style="list-style-type: none"> - If the object receives the value 1, the sun protection is reactivated. - If the object receives the value 0, the sun protection is permanently deactivated. <p>For further information, see: Sun protection.</p>				

No.	Name	Object Function	Data type	Flags
27, 67, ... 387	Output x-y	Sun protection status	1 bit - 1.011 DPT_State	C, R, T
<p>This object is activated when the Sun protection status object parameter is active. This object allows the status of the sun protection to be sent over the KNX bus. Object value: Depends on the Polarity parameter.</p> <p>0 = Authorized, 1 = Locked-up</p> <ul style="list-style-type: none"> - If the sun protection is deactivated, a telegram with logic value 1 is sent on the KNX bus. - If the sun protection is activated, a telegram with logic value 0 is sent on the KNX bus. <p>0 = Locked-up, 1 = Authorized</p> <ul style="list-style-type: none"> - If the sun protection is activated, a telegram with logic value 1 is sent on the KNX bus. - If the sun protection is deactivated, a telegram with logic value 0 is sent on the KNX bus. <p>This object is sent periodically and/or on status change. For further information, see: Sun protection.</p>				

5. Appendix

5.1 Technical data

- TYAS608D

KNX Medium	TP1-256
Supply voltage KNX	21...32 Vs SELV
Auxiliary voltage	230 V~ +10/-15%; 50/60 Hz
	240 V~ +/-6%; 50/60 Hz
Breaking capacity	μ 16 A AC1 230/240 V~
Circuit-breaker	10 A
Surge voltage	4 kV
Interlock time for changing direction of travel	software-dependent
Operating altitude	max. 2000 m
Degree of contamination	2
Maximum switching cycle rate at full load	20 switching cycle/min.
Operating temperature	5° ... +45 °C
Current consumption KNX	typ. 2 mA
Dimension	6 TE, 6 x 17.5 mm
Power dissipation	max. 2 W

- TYMS616D / TYMS620D

KNX Medium	TP1-256
Supply voltage KNX	21...32 Vs SELV
Breaking capacity	μ 16 A AC1 230/240 V~
Minimum switching current 230 V AC	100 mA
Circuit-breaker	16 A
Surge voltage	4 kV
Interlock time for changing direction of travel	software-dependent
Operating altitude	max. 2000 m
Degree of contamination	2
Maximum switching cycle rate at full load	6 switching cycle/min.
Operating temperature	5° ... +45 °C
Current consumption KNX	typ. 5 mA
Dimension TYMS616D	8 TE, 8 x 17.5 mm
Power loss TYMS616D	max. 20 W
Maximum permissible current TYMS616D	max. 176 A
Dimension TYMS620D	10 TE, 10 x 17.5 mm
Power loss TYMS620D	max. 25 W
Maximum permissible current TYMS620D	max. 200 A

5.2 Table of logical operations

Input 4	Input 3	Input 2	Input 1	OR	AND
-	-	0	0	0	0
-	-	0	1	1	0
-	-	1	0	1	0
-	-	1	1	1	1
-	0	0	0	0	0
-	0	0	1	1	0
-	0	1	0	1	0
-	0	1	1	1	0
-	1	0	0	1	0
-	1	0	1	1	0
-	1	1	0	1	0
-	1	1	1	1	1
0	0	0	0	0	0
0	0	0	1	1	0
0	0	1	0	1	0
0	0	1	1	1	0
0	1	0	0	1	0
0	1	0	1	1	0
0	1	1	0	1	0
0	1	1	1	1	0
1	0	0	0	1	0
1	0	0	1	1	0
1	0	1	0	1	0
1	0	1	1	1	0
1	1	0	0	1	0
1	1	0	1	1	0
1	1	1	0	1	0
1	1	1	1	1	1

5.3 Characteristics

Device	TYAS608D	TYMS616D	TYMS620D
Max. number of group addresses	254	500	500
Max. number of allocations	255	500	500
Objects	193	353	433

Hager Controls
BP10140
67703 Saverne Cedex, France
T +33 (0) 3 88 02 87 00
info@hager.com
hager.com