



	<h2>application software</h2>	
<ul style="list-style-type: none"> ▲ Manufacturers ▲ Hager Electro ▲ Lighting <li style="background-color: #90EE90; padding: 2px;">Dimmer 	<p>Dimmer KNX: 4 outputs</p> <p><i>Electrical/Mechanical characteristics: see product user manual</i></p>	

	Product reference	Product designation	Application software ref	TP device  Radio device 
	TYAS664AN	4-fold dimming actuator 300W, universal	STYAS664AN Version 1.x	

Content

1. General	4
1.1 About this guide	4
1.2 ETS Programming software	4
1.3 Connexion KNX secure	4
2. General Description	7
2.1 Installation of the device	7
2.1.1 Overview presentation	7
2.1.2 Connection	8
2.1.3 Physical addressing	8
2.1.4 Connection	9
2.2 Function modules of the application	10
2.2.1 Primary functions	11
2.2.2 Additional functions	12
3. Parameters	14
3.1 Definition of the general parameters	14
3.1.1 Manual mode	15
3.1.2 Check output combination when switching into manual mode	15
3.1.3 Activation of the Status indication	16
3.1.4 Activation of the logic blocks	16
3.1.5 Activation of the Device diagnosis object	16
3.1.6 Restore ETS-Parameters	17
3.1.7 Status during bus power cut or download	18
3.1.8 LED display	20
3.2 Manual mode	21
3.2.1 Duration of manual mode activation	21
3.2.2 Deactivation of manual mode	21
3.2.3 Status indication manual mode	22
3.2.4 Status after manual mode	23
3.3 Check output combination when switching into manual mode	24
3.3.1 Duration of output combination test activation	24
3.3.2 Deactivation of output combination test	24
3.3.3 Status indication of output combination test	25
3.4 Status indication	26
3.5 Logic block	28
3.5.1 Configuration of the Logic function	29
3.5.2 Logic block authorization	30
3.5.3 Logic result	32
3.6 Diagnosis	35
3.7 Function selection	37
3.7.1 Definition	38
3.7.2 ON/OFF timings function	45
3.7.3 Timer	49
3.7.4 Scene	53
3.7.5 Preset	58
3.7.6 Lock-up	63
3.7.7 Priority	68
3.7.8 Hours counter	70
3.7.9 Notifications	73
4. Communication objects	78
4.1 Communication objects General	78
4.1.1 Manual mode	79
4.1.2 Logic block	80
4.1.3 Behaviour of the device	81
4.1.4 Diagnosis	82
4.2 Output communication objects	84
4.2.1 ON/OFF	88
4.2.2 Dimming	88
4.2.3 Load memorisation	89
4.2.4 ON/OFF timings function	89
4.2.5 Status indication	90
4.2.6 Timer	91
4.2.7 Scene	92

4.2.8 Preset.....	92
4.2.9 Lock-up	93
4.2.10 Priority.....	94
4.2.11 Hours counter	95
4.2.12 Notifications	96
5. Appendix	98
5.1 Specifications.....	98
5.2 Table of logical operations	99
5.3 Characteristics	99

1. General

1.1 About this guide

This document describes the operation and parameterisation of KNX devices with the aid of the Engineering Tool Software ETS. The devices are parameterised by the ETS and the required settings for operation are made during the first installation.

1.2 ETS Programming software

The application programmes are compatible with ETS5 or ETS6 and are always available in their latest version on our Internet website.

ETS version	File extension of compatible products	File extension of compatible projects
ETS 5 (v 5.0.6 ou plus)	*.knxprod	*.knxproj
ETS 6 (v 6.0.0 ou plus)	*.knxprod	*.knxproj

- ETS Application designation

Application	Product designation	Application designation
STYAS664AN v1.0	TYAS664AN	4-fold dimming actuator 300W, universal

1.3 Connexion KNX secure

KNX Secure devices are able to encrypt and decrypt telegrams, thus adding an extra level of security to a KNX installation. This level of security can be used both during the commissioning of KNX installations as for KNX installations at runtime.

There are two types of encryption:

- KNX IP Secure : Telegrams are entirely encrypted and applied only to the KNX IP medium. This encryption must be used for KNX installations using an external IP network such as the Internet.
- KNX Data Secure : Telegrams are partly encrypted and applied to any KNX communication medium. This encryption can be used for the KNX IP medium, but only for the part of the KNX installation that is not exposed to an external IP network.

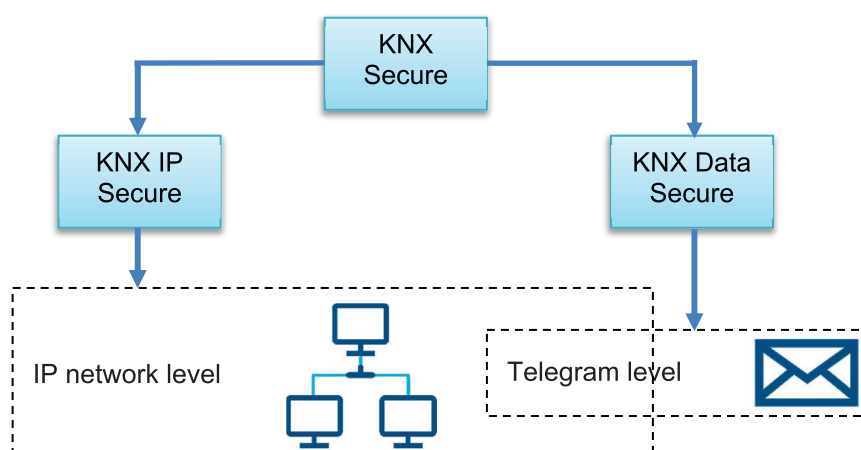

The device is KNX Data Secure capable and can be configured in the ETS project. A device certificate, which is attached to the front to the device, is required for safe commissioning. During mounting, it is recommended to remove the certificate from the device and to store it securely.

Note: It is also possible to commission the device without KNX Data-Secure. In this case, the device is not secured and behaves like other KNX devices.

Note: During the configuration of products in Secure mode, if one of the products mentioned below is installed, it is recommended to replace it by its Secure version:

- Replace the reference TYF120 (KNX/IP Interface) with the reference TYFS120
- Replace the reference TH101 (USB modular data interface) with the reference TYFS122

Commissioning of the KNX Secure mode

The device is mounted and connected ready for use.

1. Activate the secure commissioning mode in ETS.
2. Enter or scan the device certificate to add it to the project in ETS.

Note: To scan the QR code, a high-resolution camera must be used.

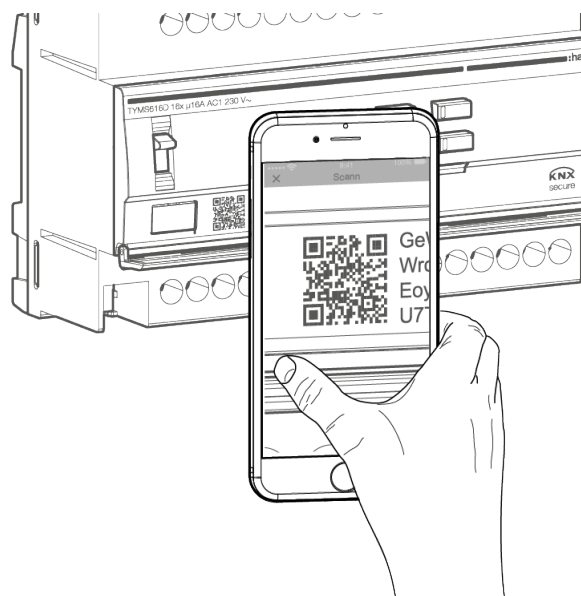

3. Record all passwords and keep them in a safe place.
4. Remove the certificate from the device (QR code) and keep it in a safe place with the passwords.

Master-Reset

The master reset restores the basic device setting.

The reset allows :

- deleting the encryption key
- deleting of the BCU password
- application of the default settings
- the application of a default individual address (15.15.255).

The device must then be recommissioned with the ETS. The manual mode is possible.

In case of Secure mode, a reinitialization deactivates the security of the device. It can then be used again with the device certificate.

How do I perform a Master Reset?

1. Switch off the device by removing the bus connection or disconnecting the power supply to the system
 2. Press and hold the lighted push button
 3. Switch on the device again by connecting the bus connection or by switching on the power supply to the system.
- The address LED lights up. After 5 seconds the LED flashes.
4. Release the address button.

The address LED lights up permanently while the master reset is in progress.

After several seconds, the LED lights off, indicating that the reset is complete. The device restarts.

Updating the firmware

The device can be updated. Firmware updates can be easily performed with the Hager ETS App. This application is free of charge and can be used on site or remotely.

How to update?

1. Login to **my.knx.org**
2. Create a new account or login with your existing account
3. Search for the **Hager Service** application
4. Add to basket
5. Go to the basket and click on Order
6. Select billing and shipping addresses
7. Click on Go to Payment
8. Confirm payment (free)Se connecter à **my.knx.org**
The application is now available in your account.
9. Download the application and the licence to update.

In the ETS project:

10. Start the application from the **Apps** tab
11. Select the device to be updated
12. Select the latest available firmware version
13. Load the device with the firmware
14. After loading is complete, activate the proprietary firmware
The device will update and restart.

2. General Description

2.1 Installation of the device

2.1.1 Overview presentation

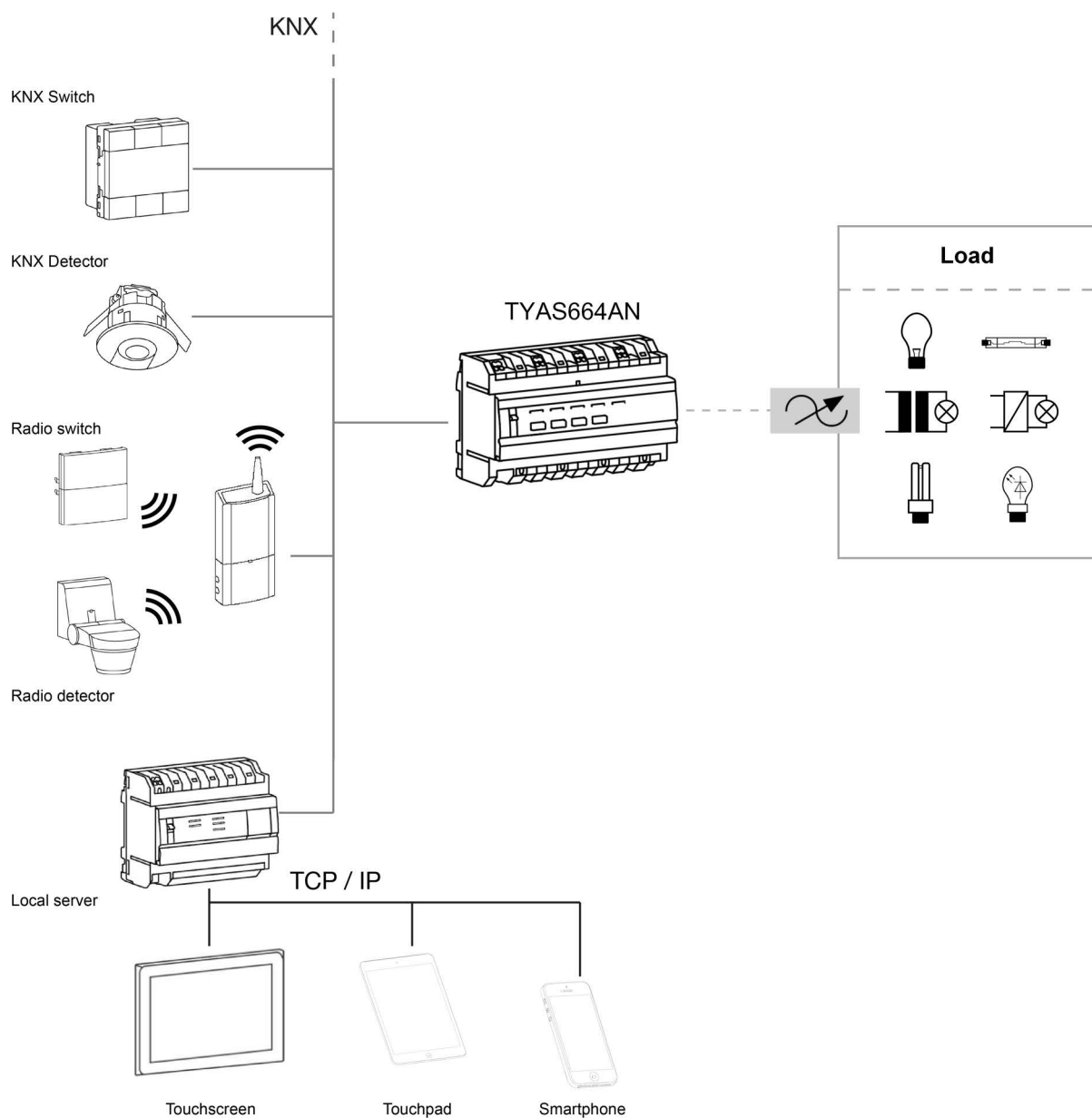

2.1.2 Connection

- TYAS664AN

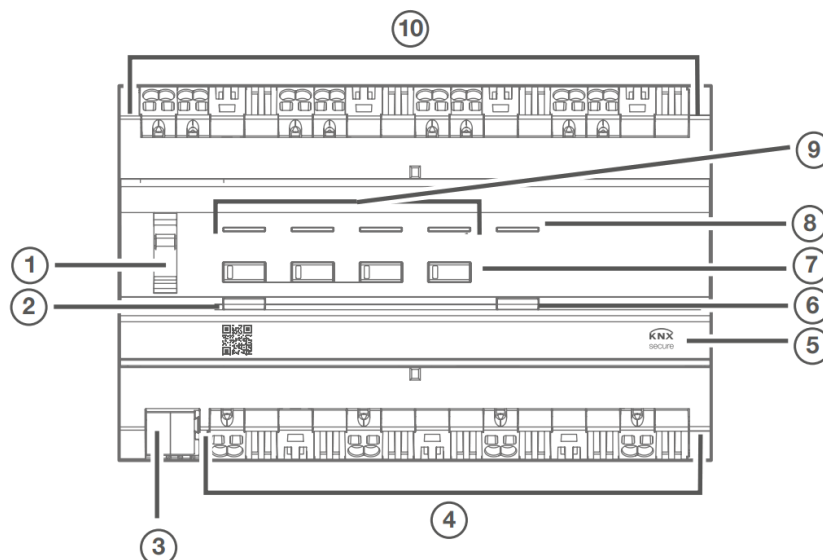

- (1) Slide switch **auto/min/max** 
- (2) Illuminated button for dimming mode
- (3) KNX bus connection terminal
- (4) Connections of loads
- (5) Labelling field with cover
- (6) Illuminated programming button
- (7) Operation button for manual operation with status LED
- (8) Control LED overheating protection
- (9) Control LED short circuit and overload protection per output
- (10) Mains supply

Note: The Min and Max settings are used to set the lowest and highest lighting levels for the outputs. These settings are achieved by storing the current output values through a long press on the relevant buttons next to the output on the front of the device.

2.1.3 Physical addressing

In order to perform the physical addressing or to check whether or not the bus is connected, press the lighted push button (6) on the right-hand side above the identification plates on the front of the device.

Light on = bus connected and ready for physical addressing.

Programming mode is activated, until the physical address is transferred from ETS. Pressing the button again, exits programming mode. Physical addressing can be carried out in automatic or manual mode.

2.1.4 Connection

- TYAS664AN

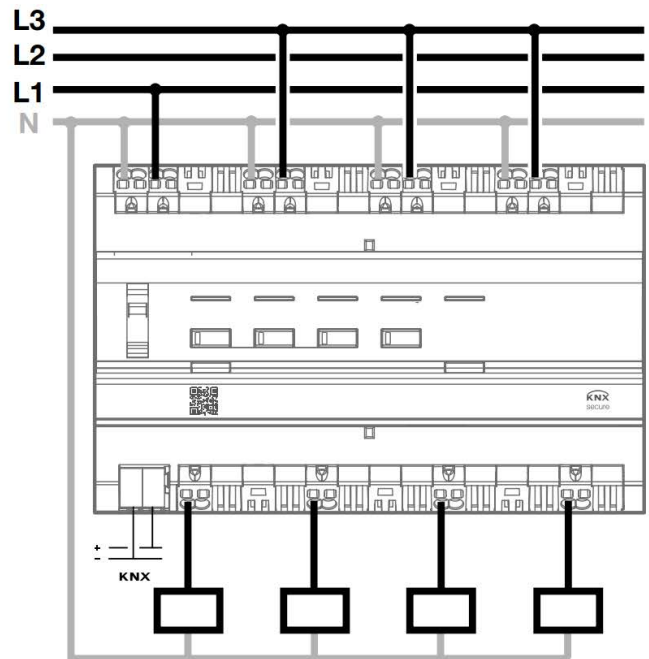
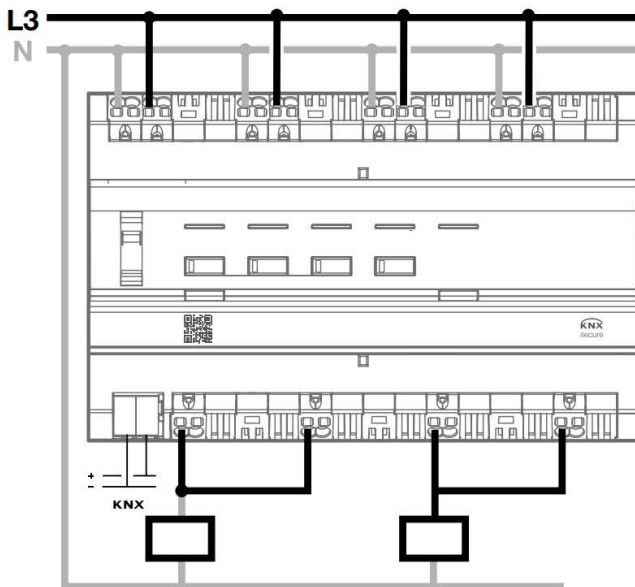
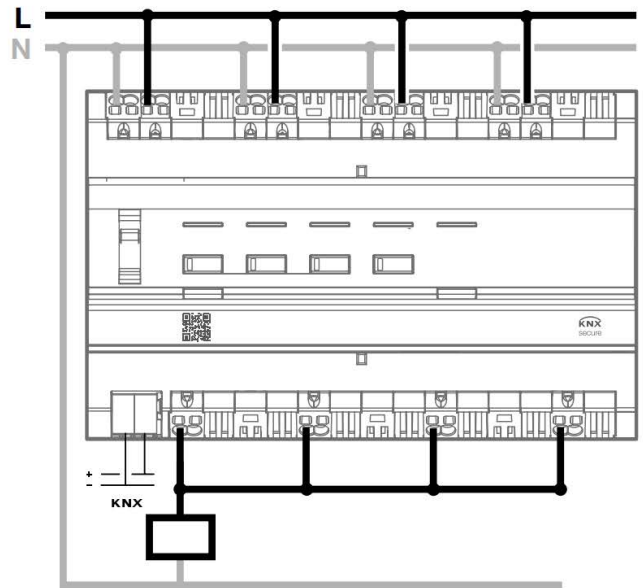
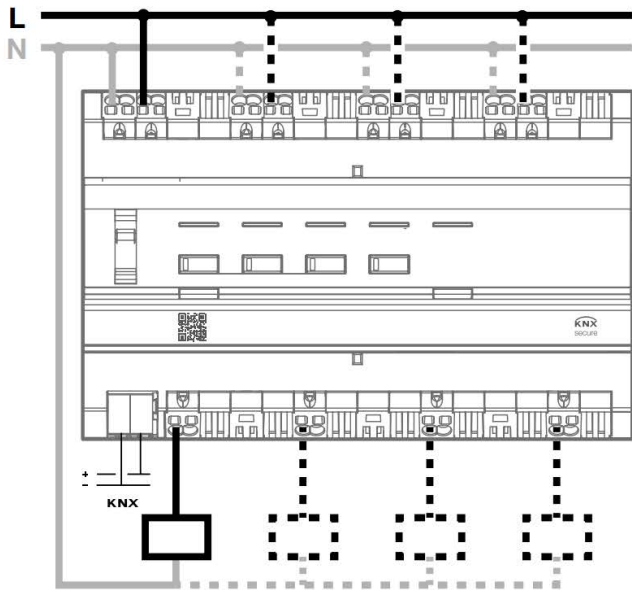

2.2 Function modules of the application

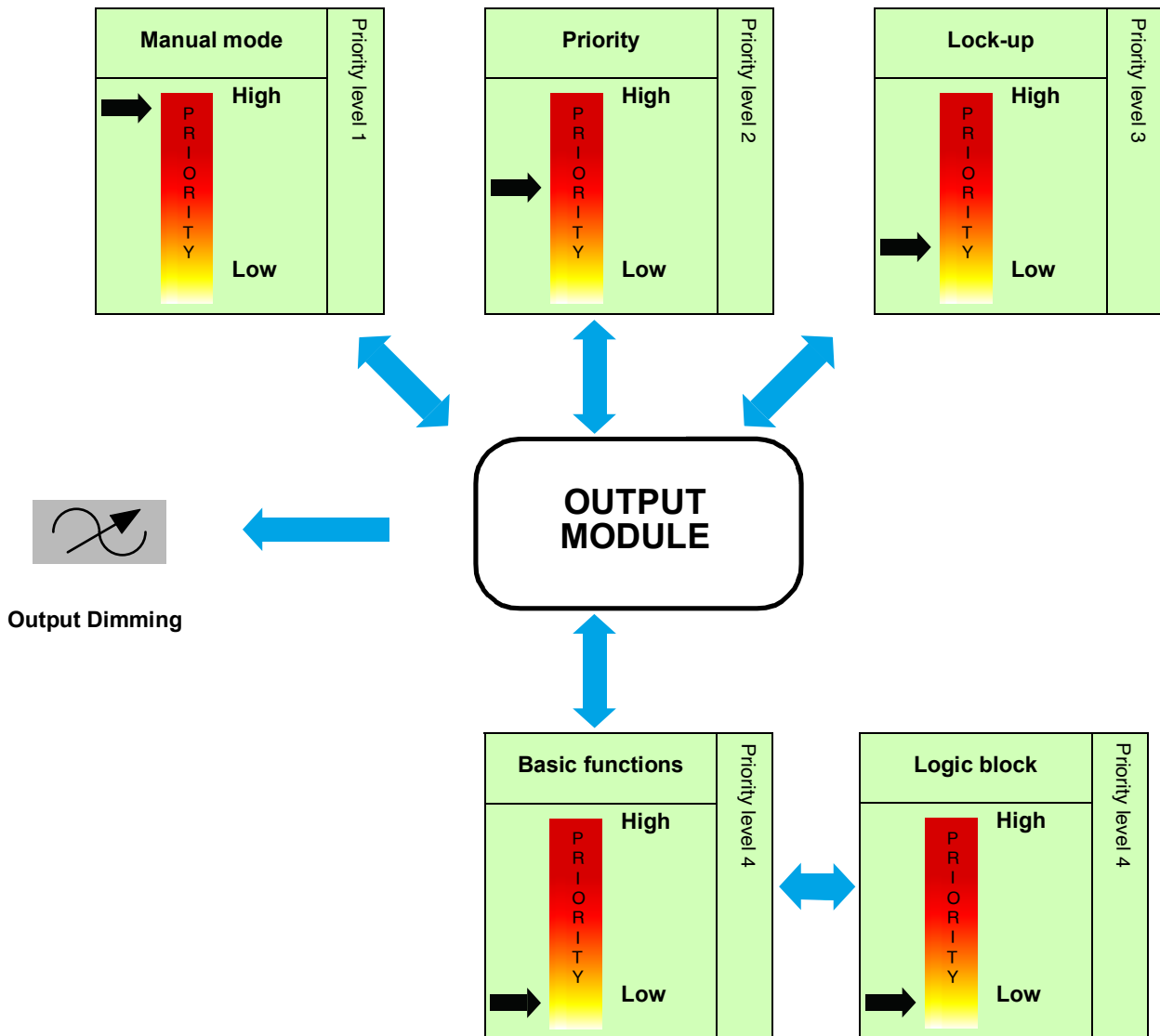

2.2.1 Primary functions

The applications allow individual configuration of the device outputs. The most important functions are:

■ ON/OFF

An output can be switched on or off using the ON/OFF function. The command can come from switches, buttons or other control inputs.

■ Relative or absolute dimming (Brightness value)

With relative dimming, the brightness value is raised or lowered with respect to the current brightness value. This is achieved, for example, by a long press on a sensor button. The dimming speed is configurable. With absolute dimming, the brightness value to be achieved is set on the dimmer as a % value.

■ Timer

The Timer function can switch a lighting circuit on or off for a configurable period. The output can be switched to a desired brightness level for a specified period. The timer may be interrupted before expiry of the delay time. A programmable Cut-OFF pre-warning announces the end of the delay time by halving the present brightness value of the output.

■ Time limited toggle switch

The Time-limited OFF function is a switching function that automatically switches off after a configurable delay time. Application: Lighting of store rooms, cellars, sheds etc.

■ Priority

The Priority function is used to force the output into a defined state. The Priority function is controlled with a 2-bit command.

Priority: Manual mode > **Priority** > Lock-up > Basic function.

Only a Priority OFF command authorizes the output for control.

Application: Keeping lighting on for security reasons.

■ Lock-up

The Lock-up function is used to lock the output in a predefined state.

Priority: Manual mode > Priority > **Lock-up** > Basic function.

The Lock-up prevents actuation until an unlock command has been received. The Lock-up duration can be set.

■ Scene

The Scene function is used to switch groups of outputs into a configurable predefined state. A scene is activated by receipt of a 1-byte command. Each output can be included in 64 different scenes.

■ Preset

The Preset function is used to switch an output into various predefined states. The Preset function is activated via an object in 1-bit format. Each output can be controlled via 2 Preset objects.

■ Delay

The Delay functions are used to activate the outputs with a switching or tripping delay or with a switching and tripping delay.

■ Timer/toggle switch changeover

The Timer/toggle switch changeover function is used to switch between a Timer and a Toggle switch function applied to the communication object ON/OFF.

■ Hours counter

The Hours Counter function is used to count the overall operating time of an output in the ON or OFF state. The counter setpoint can be programmed and altered via an object.

- Setting of the minimum and maximum brightness value

This function is used to set the minimum and maximum values for relative dimming for each output. These limits can be set using ETS parameter setting or locally on the front of the device.

- Communication objects

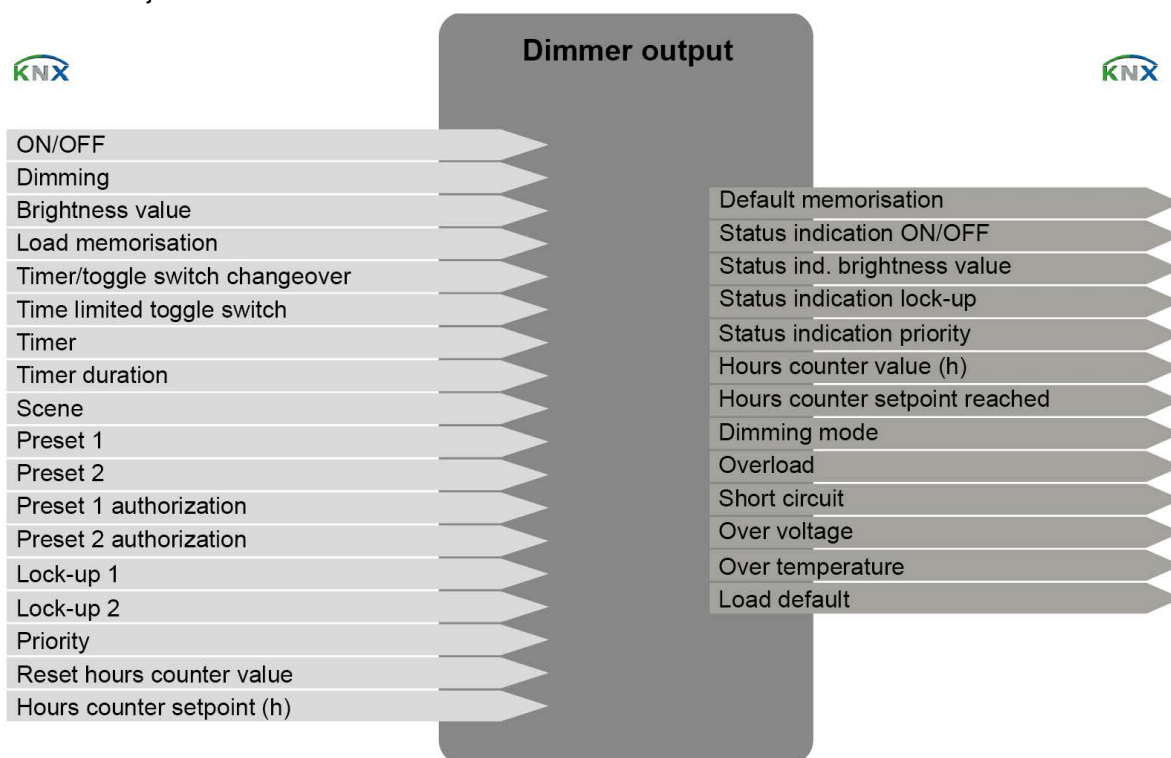

2.2.2 Additional functions

The applications configure the general functions of the devices. The following functions apply to the entire device:

- Output combination

Different combinations of channels can be used for more powerful load variations. The device automatically runs a wiring recognition test corresponding to one of the authorised combinations. After the ETS download, the device will automatically run a wiring recognition test to check the consistency between the actual cable and the parameters given in ETS.

- Manual mode

Manual mode allows the device to be disconnected from the bus. In this mode, each output can be priority controlled locally.

This command has the highest priority. No other command is considered when manual mode is active. Only after ending manual mode are other types of control again permitted. The duration of the manual control can be configured. Manual mode can be locked-up via the KNX bus.

- Status indication

The behaviour of the status indication of each switching channel can be configured for the entire device. The Status indication sends the switching status of the individual output contact on the KNX bus.

- Logic block

The Logic function is used to control an output depending on the result of a logic operation. This command has the lowest priority. The result of the function can be output on the KNX bus and can directly control one or more outputs. There are 2 logic blocks per device with up to 4 inputs available.

- Diagnosis

The Device diagnosis function allows notifications about the operating state of the device to be sent via the KNX bus. This information is sent periodically and/or on status change.

■ Selecting expert mode or dimming mode

The dimming mode for each dimming output can be specified as Expert mode using the controls on the front of the device or via the ETS dimming mode parameter.

■ Communication objects

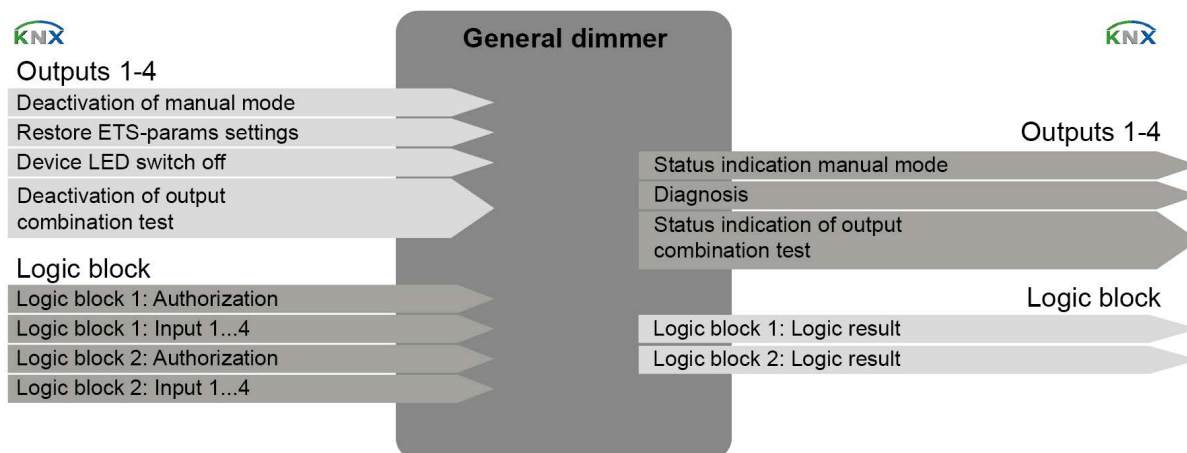

3. Parameters

The function of the different devices only differs in the number of outputs. For this reason, only one device or one output will ever be described.

3.1 Definition of the general parameters

This configuration window is used for general configuration of the device.

Outputs 1-4: Function selection		Output combination	(1) + (2) + (3) + (4)
- O1-4: Manual mode	Check output combination after main power return	<input checked="" type="radio"/> Not active	<input type="radio"/> Active until correct combination detected
- O1-4: Status indications	Check output combination after ETS download	<input type="radio"/> Not active	<input checked="" type="radio"/> Active until correct combination detected
+ Output 1			
+ Output 2	Manual mode	Active	
+ Output 3	Check output combination when switching into manual mode	Not active	
+ Output 4	Status indication	<input type="radio"/> Not active	<input checked="" type="radio"/> Active
+ Information	Logic block 1	<input checked="" type="radio"/> Not active	<input type="radio"/> Active
	Logic block 2	<input checked="" type="radio"/> Not active	<input type="radio"/> Active
	Device diagnosis object	<input checked="" type="radio"/> Not active	<input type="radio"/> Active
	Activ. of restore ETS-parameters object (scenes, timer, setpoints)	<input checked="" type="radio"/> Not active	<input type="radio"/> Active
	Parameters overwrite at next download (scenes, timer, setpoints)	<input type="radio"/> Not active	<input checked="" type="radio"/> Active
	Brightness value during bus power cut	Maintain status	
	Brightness value at bus return	Maintain status	
	Brightness value after ETS download	Maintain status	
	Brightness val.at supply return	Maintain status	
	Device LED switch off object	<input checked="" type="radio"/> Not active	<input type="radio"/> Active

Different combinations of channels can be used for more powerful load variations.

The table below sets out the different combinations:

Combination	TYAS664AN
(1) + (2) + (3) +(4)	4 x 300W
(1-2) + (3) +(4)	1 x 600W + 2 x 300W
(1) + (2) + (3-4)	2 x 300W + 1 x 600W
(1-2-3) + (4)	1 x 900W + 1 x 300W
(1-2-3-4)	1 x 1200W
(1-2) + (3-4)	2 x 600W

* Default value

Parameter	Description	Value
Output combination	This parameter defines the combination of outputs applied after the ETS parameters are downloaded. This value is stored in the product.	(1)+(2)+(3)+(4)* (1-2)+(3)+(4) (1)+(2)+(3-4) (1-2-3)+(4) (1-2-3-4) (1-2)+(3-4)

When the output combinations are modified, the previously set group addresses will be deleted.

Parameter	Description	Value
Check output combination after main power return	The output combination test following main power return is not activated.	Not active*
	The output combination test following main power return is activated until a correct combination is detected.	Active until correct combination detected

Parameter	Description	Value
Check output combination after ETS download	The output combination test after downloading ETS is not activated.	Not active
	The output combination test after ETS download is activated until a correct combination is detected.	Active until correct combination detected*

The device automatically runs a wiring recognition test corresponding to one of the authorised combinations. After the ETS download, the device will automatically run a wiring recognition test to check the consistency between the actual cable and the parameters given in ETS.

3.1.1 Manual mode

Parameter	Description	Value
Manual mode	Switching to manual mode is not possible.	Not active
	Switching to manual mode is possible without time limit.	Active*
	Manual mode can be activated for a duration that is configurable via the ETS parameters. After expiry of the time limit, manual mode is no longer active.	Time limited

For configuration see section: [Manual mode](#).

3.1.2 Check output combination when switching into manual mode

Parameter	Description	Value
Check output combination when switching into manual mode	The output combination cannot be verified.	Not active
	The output combination can be verified without time limit.	Active*
	Output combination verification can be activated for a duration configurable by ETS. At the end of time out, output combination verification is no longer active.	Time limited

For configuration see section: [Check output combination when switching into manual mode](#).

* Default value

3.1.3 Activation of the Status indication

Parameter	Description	Value
Status indication	The Status indications parameter register is hidden.	Not active
	The Status indications parameter register is displayed.	Active*

For configuration see section: [Status indication](#).

3.1.4 Activation of the logic blocks

Parameter	Description	Value
Logic block 1	Communication object and parameter register Logic block 1 are hidden.	Not active*
	Communication object and parameter register Logic block 1 are displayed.	Active

For configuration see section: [Logic block](#).

Note: The parameters and objects are identical for block 2 ; Only the terms will be adjusted.

For logic block 1

Communication objects: [128 - Logic block 1 - Input 1](#) (1 bit - 1.002 DPT_Bool)
 [132 - Logic block 1 - Logic result](#) (1 bit - 1.002 DPT_Bool)

For logic block 2

Communication objects: [134 - Logic block 2 - Input 1](#) (1 bit - 1.002 DPT_Bool)
 [138 - Logic block 2 - Logic result](#) (1 bit - 1.002 DPT_Bool)

3.1.5 Activation of the Device diagnosis object

Parameter	Description	Value
Device diagnosis object	The Device diagnosis parameter register and the associated communication object is hidden.	Not active*
	The Device diagnosis parameter register and the associated communication object are displayed.	Active

Communication object: [141 - Outputs 1-4 - Diagnosis](#) (6 byte - Specific)

For configuration see section: [Diagnosis](#).

* Default value

3.1.6 Restore ETS-Parameters

There are 2 types of parameters in the device:

- Parameters that can only be changed via ETS.
- Parameters that can be changed via ETS or via the KNX bus.

For parameters that can be changed via ETS and via the KNX bus, 2 values are stored in the device memory: The value corresponding to the ETS-parameter and the currently used value.

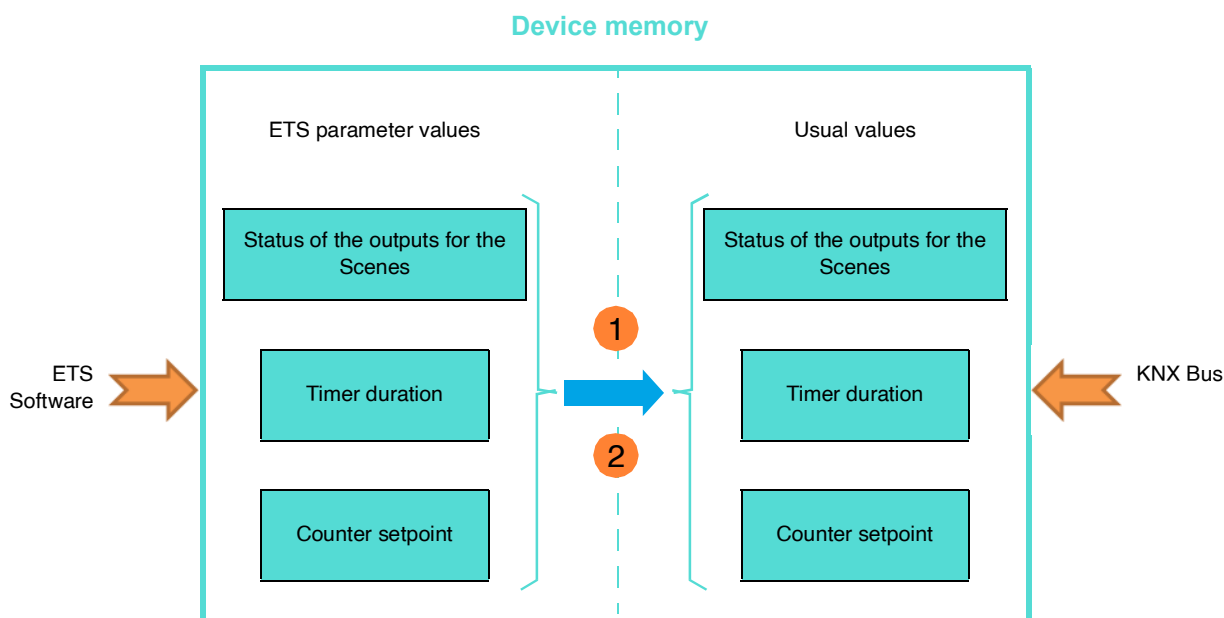

1 Receipt of the value 1 on the object, Resets the ETS parameter values:
Current parameter values are replaced by the ETS-parameter values.

2 Download of the ETS application: Current parameter values are replaced by the ETS parameter values on download.

Parameter	Description	Value
Activ. of restore ETS-parameters object (scenes, timer, setpoints)	The Restore ETS-params settings communication object is hidden.	Not active*
	The Restore ETS-params settings communication object is displayed.	Active
	On receipt of a 1 on this object, the parameters** that are adjustable via the bus are overwritten with values set in the ETS before the last download.	

** Output status for scene X, Timer duration, Hours counter setpoint.

Communication object: [139 - Outputs 1-4 - Restore ETS-params settings \(1 bit - 1.015 DPT_Reset\)](#)

Parameter	Description	Value
Parameters overwrite at next download (scenes)	The parameter values stored in the device will remain in the device at the next download.	Not active
	The parameter values stored in the device will be overwritten with the ETS configured values at the next download.	Active*

* Default value

3.1.7 Status during bus power cut or download

Parameter	Description	Value
Brightness value during bus power cut	The output status remains unchanged during a bus power cut.	Maintain status*
	The output is turned on when there is a bus power cut.	ON
	The output is turned off when there is a bus power cut.	OFF
	The output is targeted on the stored brightness value set.	Value %

Parameter	Description	Value
Brightness value during bus power cut (0-100%), last value (101)	On bus failure the output is set to the entered brightness value.	0* ... 100%
	The output status remains unchanged during a bus power cut.	101

*Note: This parameter is only visible when the **Brightness during bus power cut** parameter is assigned a value: **Value %**.*

Parameter	Description	Value
Dimming speed for brightness value during bus power cut	This parameter defines the time to reach the brightness value during bus power cut.	00h00m00s to 23h59m59s (00h00m00s*)

*Note: This parameter is only visible when the **Brightness during bus power cut** parameter is assigned a value: **Value %**.*

Parameter	Description	Value
Brightness value at bus return	The output status remains unchanged during at bus return.	Maintain status*
	The output is switched on at bus return.	ON
	The output is switched off at bus return.	OFF
	The output is targeted on the stored brightness value set.	Value %

Note: The device will reboot on bus return. The Priority functions that were present before the bus power cut, are no longer active (Priority, Lock-up).

Parameter	Description	Value
Brightness value at bus return (0-100%), last value (101)	The output varies according to the brightness value during bus return.	0 ... 100%*
	The output status remains unchanged during at bus return.	101

*Note: This parameter is only visible when the **Brightness during bus return** parameter is assigned a value: **Value %**.*

Parameter	Description	Value
Dimming speed for brightness value at bus return	This parameter defines the time to reach the brightness value at bus return.	00h00m00s to 23h59m59s (00h00m00s*)

*Note: This parameter is only visible when the **Brightness during bus return** parameter is assigned a value: **Value %**.*

* Default value

Parameter	Description	Value
Brightness value after ETS download	The output status remains unchanged after ETS download.	Maintain status*
	The output is switched on after ETS download.	ON
	The output is switched off after ETS download.	OFF
	The output is targeted on the stored brightness value set.	Value %

Note: During ETS-parameters download, the outputs remain unchanged.

Parameter	Description	Value
Brightness value after ETS download (0-100%), last value (101)	The output varies according to the brightness value after downloading the ETS parameters.	0 ... 100%*
	The output status remains unchanged after ETS download.	101

*Note: This parameter is only visible when the **Brightness after download** parameter is assigned a value: **Value %**.*

Parameter	Description	Value
Dimming speed for brightness value after ETS download	This parameter defines the dimming speed for attaining the brightness value after download of the ETS parameters.	00h00m00s to 23h59m59s (00h00m00s*)

*Note: This parameter is only visible when the **Brightness after download** parameter is assigned a value: **Value %**.*

Parameter	Description	Value
Brightness val.at supply return	After a return of power, the output status is set to the last brightness value.	Maintain status*
	The output switches to ON when the power returns.	ON
	The output switches to OFF when the power returns.	OFF
	The output is targeted on the stored brightness value set.	Value %

Parameter	Description	Value
Brightness val.at supply return (0-100%), last value (101)	After a return of power, the output is set to the stored brightness value.	0* ... 100%
	After a return of power, the output status is set to the last brightness value.	101

*Note: This parameter is only visible when the **Brightness at power return** parameter is assigned a value: **Value %**.*

Parameter	Description	Value
Dimming speed for brightness value at supply return	This parameter defines the time to reach the brightness value when the power returns.	00h00m00s to 23h59m59s (00h00m00s*)

*Note: This parameter is only visible when the **Brightness at power return** parameter is assigned a value: **Value %**.*

* Default value

3.1.8 LED display

Parameter	Description	Value
Device LED switch off object	The Device LEDs lock-up communication object is hidden.	Not active*
	The Device LEDs lock-up communication object is displayed.	Active

This function is used to reduce the overall power consumption of the device. It allows the LEDs on the front of the device to be switched off.

Communication object: [140 - Outputs 1-4 - Device LED switch off \(1 bit - 1.001 DPT_Switch\)](#)

Parameter	Description	Value
Polarity	Object Device LED lock receives: 0 = The LED display is activated 1 = The LED display is deactivated 0 = The LED display is deactivated 1 = The LED display is activated	0 = Status indication, 1 = Always OFF* 0 = Always OFF, 1 = Status indication

*Note: This parameter is only visible if the parameter **Device LED switch off object** has the following value: **Active**.*

* Default value

3.2 Manual mode

In manual mode the device is disconnected from the KNX bus.

The function of the connected load can be checked using the manual mode button. Manual mode can only be activated using the switch on the front of the device. In this mode, telegrams arriving from the KNX bus are ignored.

When manual mode is activated, the status of the relays initially remains unchanged. Each time the manual mode button of an output is pressed, its status is switched over.

The behaviour is determined by the following parameters:

Outputs 1-4: Function selection		Object deactivation of manual mode	<input type="radio"/> Not active <input checked="" type="radio"/> Active
- O1-4: Manual mode		Polarity	<input type="radio"/> 0=Manual mode locked-up, 1=Manual mode autho... <input checked="" type="radio"/> 0=Manual mode authorized, 1=Manual mode locke...
- O1-4: Status indications		Object status indication manual mode	<input type="radio"/> Not active <input checked="" type="radio"/> Active
+ Output 1		Polarity	<input checked="" type="radio"/> 0=Manual mode deactivated, 1=Manual mode acti... <input type="radio"/> 0=Manual mode activated, 1=Manual mode deacti...
+ Output 2		Emission	On status change
+ Output 3		Status after manual mode	Value %
+ Output 4		Brightness value after manual mode (0-100%)	100
+ Information		Dimming speed for brightness value after manual mode	01:00:00 hh:mm:ss

3.2.1 Duration of manual mode activation

Parameter	Description	Value
Duration of manual mode activation	This parameter defines the amount of time for which manual mode remains activated.	00h00m00s to 23h59m59s (00h30m00s*)

Note: The smallest executable time is 1 second.

Note: This parameter is only visible if the **Manual mode** parameter has the following value: **Time limited**.

3.2.2 Deactivation of manual mode

Parameter	Description	Value
Object deactivation of manual mode	The Deactivation of manual mode communication object is hidden.	Not active*
	The Deactivation of manual mode communication object is displayed.	Active

Communication object: [125 - Outputs 1-4 - Deactivation of manual mode \(1 bit - 1.001 DPT_Switch\)](#)

* Default value

Parameter	Description	Value
Polarity	<p>The Deactivate manual mode object receives:</p> <p>0 = Manual mode is activated 1 = Manual mode is not activated</p> <p>0 = Manual mode is not activated 1 = Manual mode is activated</p>	<p>0 = Manual mode authorized, 1 = Manual mode locked-up*</p> <p>0 = Manual mode locked-up, 1 = Manual mode authorized</p>

*Note: This parameter is only visible if the **Object deactivation of manual mode** parameter has the following value: **Active**.*

3.2.3 Status indication manual mode

Parameter	Description	Value
Object status indication manual mode	<p>The Status indication manual mode communication object is hidden.</p> <p>The Status indication manual mode communication object is displayed.</p>	<p>Not active*</p> <p>Active</p>

Communication object: [126 - Outputs 1-4 - Status indication manual mode \(1 bit - 1.011 DPT_State\)](#)

Parameter	Description	Value
Polarity	<p>The Status indication manual mode communication object sends:</p> <p>0 = When manual mode is switched on 1 = When manual mode is switched off</p> <p>0 = When manual mode is switched off 1 = When manual mode is switched on</p>	<p>0 = Manual mode active, 1 = Manual mode not active</p> <p>0 = Manual mode not active, 1 = Manual mode active*</p>

*Note: This parameter is only visible if the **Object status indication manual mode** parameter has the following value: **Active**.*

Parameter	Description	Value
Emission	<p>The Status indication manual mode communication object is sent:</p> <p>On switching manual mode on or off. Periodically after a configurable time.</p> <p>On switching manual mode on or off and periodically after a configurable time.</p>	<p>On status change*</p> <p>Periodically</p> <p>On status change and periodically</p>

*Note: This parameter is only visible if the **Object status indication manual mode** parameter has the following value: **Active**.*

Parameter	Description	Value
Periodicity	<p>This parameter determines the time between the individual transmissions of the Status indication manual mode object.</p>	<p>00h00m00s to 23h59m59s (00h30m00s*)</p>

*Note: This parameter is only visible if the **Emission** parameter has the following value: **Periodically** or **On status change and periodically**.Periodicity*

* Default value

3.2.4 Status after manual mode

Parameter	Description	Value
Status after manual mode	<p>At the end of manual mode, the output status is:</p> <p>Not changed.</p> <p>Is switched to the opposite status.</p> <p>Selectively switched on.</p> <p>Selectively switched off.</p> <p>Set to the stored value.</p> <p>Switched back to the status before manual mode was activated.</p> <p>Switched to the status which would be active according to other communication objects if the manual mode had not taken place.</p>	<p>Maintain status*</p> <p>Inversion</p> <p>ON</p> <p>OFF</p> <p>Value %</p> <p>Status before manual mode</p> <p>Theoretical status without manual mode</p>

Note: The application of this parameter depends on the priority of the other active functions. If a function with higher priority is active, this parameter will not be enacted. In the case where two functions with the same priority are active, the parameter of the most recently switched off function is enacted.

Note on inversion: If the brightness value is greater than or equal to 1%, the value goes to 0%. If the brightness value is less than 1%, the value goes to 100%.

Parameter	Description	Value
Brightness value after manual mode (0-100%)	This parameter defines the brightness value that is applied on the output after the end of manual mode.	0 ... 100%*

*Note: This parameter is only visible if the **Status after manual mode** parameter has the following value: **Value %**.*

Parameter	Description	Value
Dimming speed for brightness value after manual mode	This parameter defines the dimming speed for attaining the brightness value after the use of manual mode.	<p>1 hours: 0 to 23 h</p> <p>0 minutes: 0 to 59 min</p> <p>0 seconds: 0 to 59 s</p>

*Note: This parameter is only visible if the **Status after manual mode** parameter has the following value: **Value %**.*

* Default value

3.3 Check output combination when switching into manual mode

Different combinations of channels can be used for more powerful load variations. The device automatically runs a wiring recognition test corresponding to one of the authorised combinations.

This function launches this test when switching to manual mode.

The behaviour is determined by the following parameters.

Outputs 1-4: Function selection	Duration of output combination test activation	00:30:00	hh:mm:ss
- O1-4: Manual mode	Object deactivation of output combination test	<input type="radio"/> Not active	<input checked="" type="radio"/> Active
- O1-4: Output combination...	Polarity	<input checked="" type="radio"/> 0=Combination test Locked up, 1=Combination tes...	<input type="radio"/> 0=Combination test Authorized, 1=Combination te...
- O1-4: Status indications	Object status indication output combination test	<input type="radio"/> Not active	<input checked="" type="radio"/> Active
+ Output 1	Polarity	<input checked="" type="radio"/> 0=Combination test Deactiv., 1=Combination test...	<input type="radio"/> 0=Combination test Activ., 1=Combination test De...
+ Output 2	Emission	On status change and periodically	
+ Output 3	Periodicity	00:30:00	hh:mm:ss
+ Output 4			

3.3.1 Duration of output combination test activation

Parameter	Description	Value
Duration of output combination test activation	This parameter determines the time during which the output combination test will be active in manual mode.	00h00m00s to 23h59m59s (00h30m00s*)

*Note: This parameter is only visible when the **Output combination test on switching to manual mode** parameter is assigned a value: Time limited.*

3.3.2 Deactivation of output combination test

Parameter	Description	Value
Object deactivation of output combination test	The Deactivation of output combination test object is hidden.	Not active*
	The Deactivation of output combination test object is displayed.	Active

Communication object: [142 - Outputs 1-4 - Deactivation of output combination test \(1 bit - 1.003 DPT_Enable\)](#)

* Default value

Parameter	Description	Value
Polarity	<p>The Deactivation of output combination test object receives:</p> <p>0 = The output combination test is locked up 1 = The output combination test is authorized</p> <p>0 = The output combination test is authorized 1 = The output combination test is locked up</p>	<p>0=Combination test Locked up, 1=Combination test Authorized*</p> <p>0=Combination test Authorized, 1=Combination test Locked up</p>

Note: This parameter is only visible when the **Deactivation of output combination test object** parameter is assigned a value: Active.

3.3.3 Status indication of output combination test

Parameter	Description	Value
Object status indication output combination test	<p>The Status indication of output combination test object is hidden.</p> <p>The Status indication of output combination test object is displayed.</p>	<p>Not active*</p> <p>Active</p>

Communication object: [143 - Outputs 1-4 - Status indication of output combination test \(1 bit - 1.011 DPT_State\)](#)

Parameter	Description	Value
Polarity	<p>The Status indication of output combination test object is sent:</p> <p>0 = On deactivation of output combination test 1 = On activation of output combination test</p> <p>0 = On activation of output combination test 1 = On deactivation of output combination test</p>	<p>0=Combination test Deactiv., 1=Combination test Activ.*</p> <p>0=Combination test Activ., 1=Combination test Deactiv.</p>

Note: This parameter is only visible when the **Status indication of output combination test object** parameter is assigned a value: Active.

Parameter	Description	Value
Emission	<p>The Status indication of output combination test object is sent:</p> <p>On activation and deactivation of the output combination test</p> <p>Periodically after a configurable time</p> <p>On activation and deactivation of the output combination test and periodically after a configurable time</p>	<p>On status change*</p> <p>Periodically</p> <p>On status change and periodically</p>

Note: This parameter is only visible when the **Status indication of output combination test object** parameter is assigned a value: Active.

Parameter	Description	Value
Periodicity	This parameter determines the time between the individual transmissions of the Status indication of output combination test object.	00h00m00s to 23h59m59s (00h30m00s*)

Note: This parameter is only visible if the **Emission** parameter has the following value: **Periodically** or **On status change and periodically**.

* Default value

3.4 Status indication

The status Indication function specifies the status of the output contact.

Outputs 1-4: Function selection	Polarity	<input checked="" type="radio"/> 0 = OFF, 1 = ON <input type="radio"/> 0 = ON, 1 = OFF
- O1-4: Manual mode	Emission during manual mode	<input checked="" type="radio"/> Not active <input type="radio"/> Active
- O1-4: Status indications		
+ Output 1	Emission	Periodically
+ Output 2	Periodicity	00:10:00 hh:mm:ss
+ Output 3	Emission after bus power return	00:00:20 hh:mm:ss
+ Output 4		
+ Information	Brightness value emission during manual mode	<input checked="" type="radio"/> Not active <input type="radio"/> Active
	Brightness value emission	On status change
	Emission brightness value after bus power return	00:00:20 hh:mm:ss

Parameter	Description	Value
Polarity	The Status indication ON/OFF communication object sends: 0 = For an open output contact 1 = For a closed output contact 0 = For a closed output contact 1 = For an open output contact	0 = OFF, 1 = ON* 0 = ON, 1 = OFF

*Note: If the Blinking function is activated, the above parameter is ignored and replaced by the **Output status during Blinking function** parameter.*

Parameter	Description	Value
Emission during manual mode	The Status indication ON/OFF communication object sends: Values if the output status is switched in manual mode. No values if the output status is switched in manual mode.	Active* Not active

Parameter	Description	Value
Emission	The Status indication ON/OFF communication object is sent: On each output change. Periodically after a configurable time. On output change and periodically after a configurable time.	On status change* Periodically On status change and periodically

* Default value

Parameter	Description	Value
Periodicity	This parameter determines the time between the individual transmissions of the Status indication ON/OFF object.	00h00m00s to 23h59m59s (00h10m00s*)

Note: The smallest executable time is 1 second.

Note: This parameter is only visible if the **Emission** parameter has the following value: **Periodically** or **On status change and periodically**.

Parameter	Description	Value
Emission after bus power return	This parameter determines the delay for emission of the Status indication ON/OFF object on return of the KNX bus after a power cut.	00h00m00s to 23h59m59s (00h00m20s*)

Note: The smallest executable time is 1 second.

Note: This parameter can be used to optimize the bus load after the return of the KNX bus voltage.

Parameter	Description	Value
Brightness value emission during manual mode	The Status ind. brightness value communication object sends Values if the output status is switched in manual mode. No values if the output status is switched in manual mode.	Not active* Active

Parameter	Description	Value
Brightness value emission	The Status ind. brightness value communication object is sent: On each output change. Periodically after a configurable time. On output change and periodically after a configurable time.	On status change* Periodically On status change and periodically

Parameter	Description	Value
Periodicity	This parameter determines the time between the individual transmissions of the Status ind. brightness value .	00h00m00s to 23h59m59s (00h10m00s*)

Note: This parameter is only visible if the **Brightness value emission** parameter has the following value: **Periodically** or **On status change and periodically**.

Parameter	Description	Value
Emission brightness value after bus power return	This parameter determines the delay for emission of the Status ind. brightness value object on return of the KNX bus after a power cut.	00h00m00s to 23h59m59s (00h00m20s*)

This parameter can be used to optimize the bus load after the return of the KNX bus voltage.

* Default value

3.5 Logic block

The Logic function is used to control an output depending on the result of a logic operation. This command has the lowest priority.

The result of the function can be output on the KNX bus and may directly relate to the status of one or more outputs. 2 logic blocks are available for each device.

The behaviour is determined by the following parameters:

Note: The description of the parameters is given for logic block 1. The parameters and objects are identical for logic block 2 ; Only the terms will be adjusted.

Outputs 1-4: Function selection	Logic function type	<input type="radio"/> AND <input checked="" type="radio"/> OR
- O1-4: Manual mode	Number of logic inputs	1
- O1-4: Status indications	Inverting value of logic input 1	<input checked="" type="radio"/> Maintain status <input type="radio"/> Status inversion
- O1-4: Logic block 1	Value at initialization of logic input 1	Value before initialization
- O1-4: Logic block 2	Authorization object logic block	<input type="radio"/> Not active <input checked="" type="radio"/> Active
+ Output 1	Value at initialization	Value before initialization
+ Output 2	Polarity	<input checked="" type="radio"/> 0 = Locked-up , 1 = Authorized <input type="radio"/> 0 = Authorized, 1 = Locked-up
+ Output 3	Logic result after autorisation	<input checked="" type="radio"/> Immediate emission when authorization <input type="radio"/> No immediate emission
+ Output 4	Emission of logic result	<input type="radio"/> By input value change <input checked="" type="radio"/> By logic result value change
+ Information	Logic result acts on outputs	<input type="radio"/> Not active <input checked="" type="radio"/> Active
	Output 1	<input type="radio"/> No <input checked="" type="radio"/> Yes
	Output 2	<input type="radio"/> No <input checked="" type="radio"/> Yes
	Output 3	<input type="radio"/> No <input checked="" type="radio"/> Yes
	Output 4	<input type="radio"/> No <input checked="" type="radio"/> Yes
	Action if logic result = 0	OFF
	Action if logic result = 1	ON

Operating principle of the logic block:

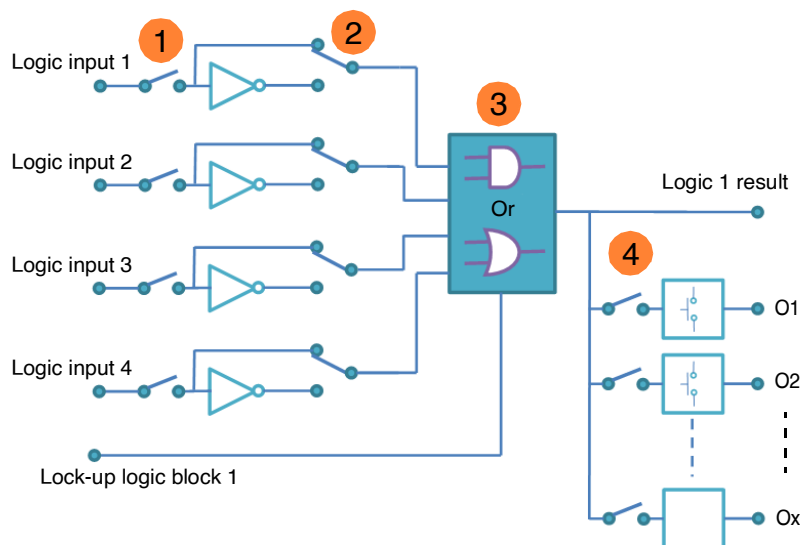

- ① Logic input number: Allows authorization of the logic input
- ② Logic input value: Inverted, yes or no
- ③ Type of logic function (AND or OR): Selection of the logic function
- ④ The logic result is applied to outputs: Selection of the outputs concerned by the logic operation

3.5.1 Configuration of the Logic function

Parameter	Description	Value
Logic function type	The input objects are: OR linked. AND linked.	Or* And

For logic table see: [Appendix](#).

Parameter	Description	Value
Number of logic inputs	This parameter determines the number of inputs of the logic block. Up to 4 inputs can be used.	1* 2 3 4

Communication objects:

- Block 1
 - 129 - Logic block 1 - Input 2 (1 bit - 1.002 DPT_Bool)
 - 130 - Logic block 1 - Input 3 (1 bit - 1.002 DPT_Bool)
 - 131 - Logic block 1 - Input 4 (1 bit - 1.002 DPT_Bool)
- Block 2
 - 135 - Logic block 2 - Input 2 (1 bit - 1.002 DPT_Bool)
 - 136 - Logic block 2 - Input 3 (1 bit - 1.002 DPT_Bool)
 - 137 - Logic block 2 - Input 4 (1 bit - 1.002 DPT_Bool)

* Default value

Parameter	Description	Value
Inverting value of logic input x	The value of logic input x works on the logic block: With its object value (0=0, 1=1). With inverted object value (0=1, 1=0).	Maintain status* Status inversion

x = 1 to 4

Parameter	Description	Value
Value at initialization of logic input x	On initialization of the device after a download or after return of the bus power, the value of the logic input is: Set to 0. Set to 1. Set according to the value of the logic input before the initialization occurred.	0 1 Value before initialization*

x = 1 to 4

3.5.2 Logic block authorization

Principle of logic block authorization:

The parameters are set as follows:

- Logic block authorization: 0 = Locked-up, 1 = Authorized.
- Action if logic result = 0 : Scene 1.
- Action if logic result = 1 : Scene 2.
- Logic input 1 and 2 are AND-linked.
- Emission of logic result: By input value change.

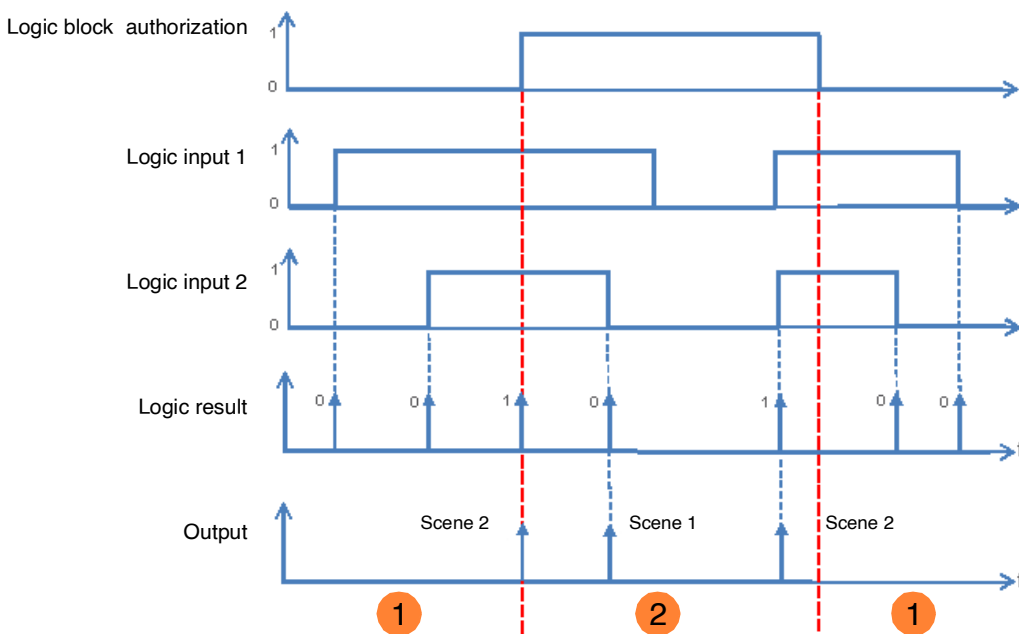

- 1 The logic result has no influence on the outputCurrent values.
- 2 The commands from the logic result are executed.

*Note: The commands from the logic result are executed immediately after authorization, according to the **Logic result after authorization** parameter.*

* Default value

Parameter	Description	Value
Authorization object logic block	The Logic block 1 – Authorization communication object and related parameters are hidden.	Not active*
	The Logic block 1 – Authorization communication object and related parameters are displayed.	Active

Note: If the logic block is locked the logic operation is not processed.

Communication objects: **Block 1** **127 - Logic block 1 - Authorization (1 bit - 1.003 DPT_Enable)**
 Block 2 **133 - Logic block 2 - Authorization (1 bit - 1.003 DPT_Enable)**

Parameter	Description	Value
Value at initialization	On initialization of the device after a download or after return of the bus power, the value of the Logic block 1 – Authorization object is:	
	Set to 0.	0
	Set to 1.	1
	Set according to the value that the object had before initialization.	Value before initialization*

*Note: This parameter is only visible if the **Authorization object logic block** parameter has the following value: **Active**.*

Parameter	Description	Value
Polarity	On receipt of a value on the Logic block 1 – Authorization object, this is:	
	Locked-up on object value 1.	0 = Authorized, 1 = Locked-up
	Locked-up on object value 0.	0 = Locked-up, 1 = Authorized*

*Note: This parameter is only visible if the **Authorization object logic block** parameter has the following value: **Active**.*

Parameter	Description	Value
Logic result after autorisation	On authorization of the logic block:	
	The value of the Logic result is immediately determined.	Immediate emission when authorization*
	The value of the logic result is first determined after receipt of a value on a logic input.	No immediate emission

*Note: This parameter is only visible if the **Authorization object logic block** parameter has the following value: **Active**.*

* Default value

3.5.3 Logic result

Parameter	Description	Value
Emission of logic result	The Logic result object will be sent on: Each receipt of a telegram on one of the logic inputs. A change in the value of the logic result.	By input value change By logic result value change*

Parameter	Description	Value
Logic result acts on outputs	The logic results acts: Only on the Logic result communication object. On the Logic result communication object and directly on one or more outputs.	Not active* Active

The status of the affected outputs is determined by the parameter **action on logic result = x**.

Parameter	Description	Value
Output 1 ... x	The output relationship with the Logic result is: Directly dependent. Independent.	Yes* No

*Note: This parameter is only visible if the **Logic result acts on outputs** parameter has the following value: **Active**.*

Parameter	Description	Value
Action if logic result = 0	On the outputs that are directly dependent on Logic result, if the output value = 0, the status: Not changed. Is switched to the opposite status. Selectively switched on. Selectively switched off. Set to the stored value. Starts timer mode. Stops timer mode. Starts one of the 64 scenes. Adopts the default value given by the parameter Status if preset 1 object = 0 . Adopts the default value given by the parameter Status if preset 2 object = 0 .	Maintain status Inversion ON OFF* Value % Timer start Timer stop Scene number Preset 1 Preset 2

Note on inversion: If the brightness value is greater than or equal to 1%, the value goes to 0%. If the brightness value is less than 1%, the value goes to 100%.

Note: The Timer mode, Scene function or Preset function of the selected output must be configured. If this is not the case, the status remains unchanged.

* Default value

Parameter	Description	Value
Brightness val.logic result=0 (0-100%)	This parameter determines the brightness value that is applied if the logic result is 0 after the re-evaluation.	0 ... 100%*

Note: This parameter is only visible if the **Action if logic result = 0** parameter has the following value: **Value %**.

Parameter	Description	Value
Dimming speed for brightness value during logic result = 0	This parameter determines the dimming speed to attain the brightness value if the logic result is 0 after re-evaluation.	00h00m00s to 23h59m59s (00h00m00s*)

Note: This parameter is only visible if the **Action if logic result = 0** parameter has the following value: **Value %**.

Parameter	Description	Value
Scene if logic result = 0	This parameter determines the scene number that is activated if the logic result is 0 after re-evaluation.	Scene 1 ... 64 Default value: 1

The outputs respond according to the scene numbers and associated parameters.

Note: This parameter is only visible if the **Action if logic result = 0** parameter has the following value: **Scene number**.

Parameter	Description	Value
Action if logic result = 1	On the outputs that are directly dependent on Logic result, if the output value = 1, the status: Not changed. Is switched to the opposite status. Selectively switched on. Selectively switched off. Set to the stored value. Starts timer mode. Stops timer mode. Starts one of the 64 scenes. Adopts the default value given by the parameter Status if preset 1 object = 0 . Adopts the default value given by the parameter Status if preset 2 object = 0 .	Maintain status Inversion ON* OFF Value % Timer start Timer stop Scene number Preset 1 Preset 2

Note on inversion: If the brightness value is greater than or equal to 1%, the value goes to 0%. If the brightness value is less than 1%, the value goes to 100%.

Note: The Timer mode, Scene function or Preset function of the selected output must be configured. If this is not the case, the status remains unchanged.

Parameter	Description	Value
Brightness val.logic result=1 (0-100%)	This parameter determines the brightness value that is applied if the logic result is 1 after the re-evaluation.	0 ... 100%*

Note: This parameter is only visible if the **Action if logic result = 1** parameter has the following value: **Value %**.

* Default value

Parameter	Description	Value
Dimming speed for brightness value during logic result = 1	This parameter determines the dimming speed to attain the brightness value if the logic result is 0 after re-evaluation.	00h00m00s to 23h59m59s (00h00m00s*)

*Note: This parameter is only visible if the **Action if logic result = 1** parameter has the following value: **Value %**.*

Parameter	Description	Value
Scene if logic result = 1	This parameter determines the scene number that is activated if the logic result is 1 after re-evaluation.	Scene 1 ... 64 Default value: 2

The outputs respond according to the scene numbers and associated parameters.

*Note: This parameter is only visible if the **Action if logic result = 1** parameter has the following value: **Scene number**.*

* Default value

3.6 Diagnosis

The **Device diagnosis** object allows notifications about the operating status of the device to be sent via the KNX bus. This information is sent periodically and/or on status change.

The **Device diagnosis** object allows reporting of current faults according to the device and application. It also allows sending of the position of the switch on the front of the device and the number of the output that is affected by the fault(s).

The **Device Diagnosis** object is a 6-byte object that is composed as described below:

Byte number	6 (MSB)	5	4	3	2	1 (LSB)
Use	Switch position	Application type	Output number	Error codes		

Details of the byte:

- **Bytes 1 to 4:** Correspond to the error codes.

b31	b30	b29	b28	b27	b26	b25	b24	b23	b22	b21	b20	b19	b18	b17	b16	b15	b14	b13	b12	b11	b10	b9	b8	b7	b6	b5	b4	b3	b2	b1	b0
X	X	X	X	28	27	26	X	X	X	X	21	20	19	18	17	X	X	X	X	X	11	X	9	X	X	X	X	X	X	X	X

N°	Faults
26	Interruption to the power supply: The supply voltage of 230V is not available. The device continues to run thanks to the supply on the KNX bus.
27	Wrong context: The user's parameters are not transferable. The standard parameters are restored.
28	TP communication out of operation: Communication via the KNX bus was not available on the previous start.
17	Overload at the output: The output current flowing through the output contact is too high.
18	Short circuit on the output: The dimmer automatically reduces the available power and no longer controls the load.
19	Over temperature on the output: The available power is reduced as long as the overtemperature is present.
20	Load default on output: The load on the corresponding output is non-existent or defective.
21	Malfunction of the device switch: The position of the AUTO/MIN/MAX/MANU switch can not be determined (e.g. because of a fault with the internal contact).
9	Excessive number of restarts: This bit is use for notification of repeated restarts and/or a restart triggered by a Watch-Dog. Such a restart is not necessarily apparent to the user from the function, rather it is manifest as a disturbed environment or a bad contact of the power supply.
11	Over voltage at the output: The dimmer automatically reduces the available power and no longer controls the load.

Note: The use of the standard bit depends on the type of device used (switch actuator, dimmer, shutter/blind, etc.). Certain bit are same for all devices and others are application-specific.

- **Byte 5:** Corresponds to the application type and the number of the output affected by the error.

MSB LSB

b7	b6	b5	b4	b3	b2	b1	b0
Application type				Output number			
0 = Not defined				0 = Device error			
1 = Switch actuator				1 = Output 1			
2 = Shutter/blind				2 = Output 2			
3 = Dimmer						
				Y = Output Y			

Note: Y is the placeholder for the maximum number of outputs.

- **Byte 6:** Switch position.

MSB LSB

b7	b6	b5	b4	b3	b2	b1	b0
X	X	X	X	X	X	X	1

1: 0 = Automatic mode / 1 = Manual mode

Note: Bit marked with an x are not used.

Outputs 1-4: Function selection	Emission	On status change and periodically
- O1-4: Manual mode	Periodicity	00:30:00 hh:mm:ss
- O1-4: Status indications		
- O1-4: Device diagnosis		

Parameter	Description	Value
Emission	The Device diagnosis communication object is sent to bus: On each change. Periodically after a configurable time. On change and periodically after a configurable time.	On status change* Periodically On status change and periodically

Parameter	Description	Value
Periodicity	This parameter determines the time between the individual transmissions of the Device diagnosis object.	00h00m00s to 23h59m59s (00h30m00s*)

Note: The smallest executable time is 1 second.

Note: This parameter is only visible if the **Emission** parameter has the following value: **Periodically** or **On status change and periodically**.

* Default value

3.7 Function selection

This parameter window is used to set the device outputs. These parameters are available individually for each output.

Outputs 1-4: Function selection	Local min/max relative dimming limit settings	<input checked="" type="radio"/> Not active <input type="radio"/> Active
- O1-4: Manual mode	Apply relative min/max values after download	<input type="radio"/> Not active <input checked="" type="radio"/> Active
- O1-4: Status indications	Dimming mode after download	<input checked="" type="radio"/> Values set on product <input type="radio"/> Values settings in ETS
- Output 1	Authorization of the expert button	<input type="radio"/> Not active <input checked="" type="radio"/> Active
Output 1: Function selection	Load memorisation	<input checked="" type="radio"/> Not active <input type="radio"/> Active
+ Output 2	Relative dimming speed	<input type="text" value="00:00:04"/> hh:mm:ss
+ Output 3	Switch on speed	<input type="text" value="00:00:04"/> hh:mm:ss
+ Output 4	Switch off speed	<input type="text" value="00:00:02"/> hh:mm:ss
+ Information	Brightness value at switch ON (0-100%), last value (101)	<input type="text" value="101"/>
	Minimum relative dimming value (1 - 50%)	<input type="text" value="1"/>
	Maximum relative dimming value (51-100%)	<input type="text" value="100"/>
	Switching ON by long press	<input type="radio"/> Not active <input checked="" type="radio"/> Active
	Switching OFF by long press	<input type="radio"/> Not active <input checked="" type="radio"/> Active
	Manual mode active for output 1	<input type="radio"/> No <input checked="" type="radio"/> Yes
	Status indication	<input type="radio"/> No <input checked="" type="radio"/> Yes
	Status indication ON/OFF	<input type="radio"/> Not active <input checked="" type="radio"/> Active
	Status ind. brightness value	<input type="radio"/> Not active <input checked="" type="radio"/> Active
	ON/OFF timings function	<input checked="" type="radio"/> Not active <input type="radio"/> Active
	Timer	<input checked="" type="radio"/> Not active <input type="radio"/> Active
	Scene	<input checked="" type="radio"/> Not active <input type="radio"/> Active
	Preset	<input type="text" value="Not active"/>
	Lock-up	<input type="text" value="Not active"/>
	Priority	<input checked="" type="radio"/> Not active <input type="radio"/> Active
	Hours counter	<input checked="" type="radio"/> Not active <input type="radio"/> Active
	Notifications	<input checked="" type="radio"/> Not active <input type="radio"/> Active

3.7.1 Definition

Dimmer and switch principle:

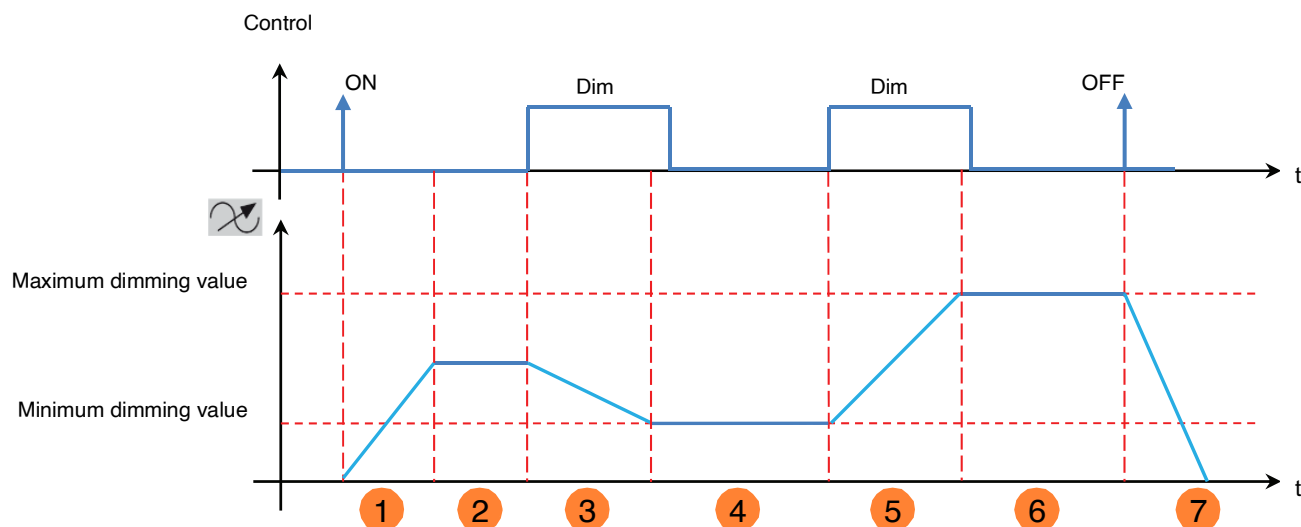

- 1 Switch ON speed (soft ON)
- 2 Brightness value at switch ON (0-100%), last value (101)
- 3 Relative dimming speed
- 4 Minimum relative dimming value (1 - 50%)
- 5 Relative dimming speed
- 6 Maximum relative dimming value (51-100%)
- 7 Switch OFF speed (soft OFF)

Upper and lower values can be set for the relative dimming for each output of the device. This configuring can be carried out over the KNX bus or locally using the buttons on the front of the device. The following parameters are used to configure the device for local settings.

Parameter	Description	Value
Local min/max relative dimming limit settings	The setting of a min/max value for relative dimming using the controls on the front of the device Is not possible. Is possible.	Not active* Active

Parameter	Description	Value
Apply relative min/max values after download	After an ETS download the local min/max dimming value settings are Maintained. Replaced by the ETS configured values.	Not active Active*

Note: To manually save the minimum values for the relative dimming, the input range must be between 1% and 50%. To manually save the maximum values for the relative dimming, the input range must be between 51% and 100%.

On restarting after a download or using the ETS configuration tool, the limits for relative dimming are restored according to the value of the following parameter:

* Default value

Parameter	Description	Value
Dimming mode after download	<p>The dimming mode (inductive, capacitive, LED, etc.) after an ETS download, involves.</p> <p>The dimming mode configured using the controls on the front of the device.</p> <p>The dimming mode set using the ETS configuration.</p>	<p>Values set on product*</p> <p>Values settings in ETS</p>

The dimmers have a load memorisation function in order to control dimmable fluocompact lamps and LED lamps more effectively. It is also possible to set the dimming mode intended for the connected load type.

The learning procedure can be initiated in various ways:

- Receipt of a 1 on the **Load memorisation** communication object enables the start of the learning proces.
- Load memorisation can also be started by a specific operating sequence of a KNX button.
 - Give KNX short presses on the 5 button configured for dimming (5 x ON, 5 x OFF or 5 x ON/OFF) and then one long press, until the load switches itself off.
 - Give a short press of the button to start the memorisation (Give a brief press on the push button to launch memorisation (two presses to return to factory dimming mode)).

This process lasts around 30 seconds and results in varying brightness.

After the memorisation, the load is activated on the highest step and blinks once, to report that the learning is completed.

The minimum brightness can depend on the connected load.

This learning process can be authorized or disabled using the **Load memorisation** parameter.

This learning process can also be started using the controls on the front of the device; See product user manual.

If a normal load is connected again, the device can be reset to the factory settings as follows:

After the 5 button press sequence (see section on learning the load) give two further short presses. The device acknowledges the restoration of the factory settings by blinking the load twice.

If there are no further presses of the buttons in the 10 seconds after the button pressing sequence, the device returns to the previous dimming mode.

This mode is ideal for conventional loads.

It is also possible to set the dimming mode intended for the connected load type via the ETS.

Parameter	Description	Value
Dimming mode selection	<p>After the next ETS download, the dimming mode of the device is set as follows:</p> <p>Automatic load recognition of inductive and capacitive loads.</p> <p>Optimized dimming behaviour for energy saving lamps.</p> <p>Optimized dimming behaviour for LEDs.</p> <p>Phase control for inductive loads.</p> <p>Phase control for capacitive loads.</p> <p>When the load is first switched ON after the ETS download, the learning procedure for LEDs and energy saving lamps is started.</p>	<p>Factory setting*</p> <p>CFL</p> <p>LED</p> <p>Inductive†load</p> <p>Capacitive load</p> <p>Load memorisation</p>

*Note: This parameter is only visible if the **Dimming mode after download** parameter has the following value: **Values settings in ETS**.*

Parameter	Description	Value
Authorization of the expert button	Setting of the dimming mode using the expert button on the front of the device is Is not possible. Is possible.	Not active Active*

Parameter	Description	Value
Load memorisation	The learning of the load via KNX commands is Is not possible. Is possible.	Not active Active*

Parameter	Description	Value
Relative dimming speed	This parameter determines the dimming speed for the brightness steps from 0% to 100% (Long press of the dimmer switch).	00h00m00s to 23h59m59s (00h00m04s*)

Parameter	Description	Value
Switch ON speed (soft ON)	This parameter defines the switch ON speed for attaining the brightness value after input of an ON command.	00h00m00s to 23h59m59s (00h00m04s*)

Parameter	Description	Value
Switch OFF speed (soft OFF)	This parameter defines the switch OFF speed for attaining brightness value 0% after input of an OFF command.	00h00m00s to 23h59m59s (00h00m02s*)

Parameter	Description	Value
Brightness value at switch ON (0-100%), last value (101)	On receipt of an ON command on the ON/OFF communication object, the output is set to the following value To the stored brightness value. To the last brightness value.	0 ... 100% 101*

Parameter	Description	Value
Minimum relative dimming value (1 - 50%)	This parameter specifies a minimum brightness value for the dimming.	1* ... 50

Parameter	Description	Value
Maximum relative dimming value (51-100%)	This parameter specifies a maximum brightness value for the dimming.	51 ... 100*

* Default value

Parameter	Description	Value
Switching ON by long press	Switching ON the output by relative dimming (long button press or 4-bit command) Is not possible. Is possible.	Not active Active*

Parameter	Description	Value
Switching OFF by long press	Switching OFF the output by relative dimming (long button press or 4-bit command) Is not possible. Is possible.	Not active Active*

Parameter	Description	Value
Manual mode active for output 1	This output can be controlled in manual mode. This output is excluded from manual mode.	Yes* No

Parameter	Description	Value
Status indication	The Status indication communication objects and the associated parameters are hidden. The Status indication communication objects and the associated parameters are displayed.	No Yes*

Parameter	Description	Value
Status indication ON/OFF	The Status indication ON/OFF communication object is: Hidden. Displayed, the status indication can be transmitted over the bus.	Not active Active*

Communication objects:

- [8 - Output 1 - Status indication ON/OFF \(1 bit - 1.001 DPT_Switch\)](#)
- [39 - Output 2 - Status indication ON/OFF \(1 bit - 1.001 DPT_Switch\)](#)
- [70 - Output 3 - Status indication ON/OFF \(1 bit - 1.001 DPT_Switch\)](#)
- [101 - Output 4 - Status indication ON/OFF \(1 bit - 1.001 DPT_Switch\)](#)

*Note: The transmission conditions for the Status indication objects must be set in the parameter Register **O1-Ox: Status indication**.*

Parameter	Description	Value
Status ind. brightness value	The Status ind. brightness value communication object is: Hidden. Displayed, the status indication can be transmitted over the bus.	Not active Active*

* Default value

Communication objects:

- 9 - Output 1 - Status ind. brightness value** (1 byte - 5.001 DPT_Scaling)
- 40 - Output 2 - Status ind. brightness value** (1 byte - 5.001 DPT_Scaling)
- 71 - Output 3 - Status ind. brightness value** (1 byte - 5.001 DPT_Scaling)
- 102 - Output 4 - Status ind. brightness value** (1 byte - 5.001 DPT_Scaling)

*Note: The transmission conditions for the Status indication objects must be set in the parameter Register **O1-Ox: Status indication**.*

Parameter	Description	Value
ON/OFF timings function	The ON/OFF timings function tab and the associated parameters and objects are: Hidden. Displayed.	Not active* Active

For configuration see section: [ON/OFF timings function](#).

Parameter	Description	Value
Timer	The Timer tab and the associated parameters and objects are: Hidden. Displayed.	Not active* Active

Communication objects:

- 10 - Output 1 - Timer** (1 bit - 1.001 DPT_Switch)
- 41 - Output 2 - Timer** (1 bit - 1.001 DPT_Switch)
- 72 - Output 3 - Timer** (1 bit - 1.001 DPT_Switch)
- 103 - Output 4 - Timer** (1 bit - 1.001 DPT_Switch)

For configuration see section: [Timer](#).

Parameter	Description	Value
Scene	The Scenes tab and the associated parameters and objects are: Hidden. Displayed.	Not active* Active

Communication objects:

- 12 - Output 1 - Scene** (1 byte - 17.001 DPT_SceneNumber)
- 43 - Output 2 - Scene** (1 byte - 17.001 DPT_SceneNumber)
- 74 - Output 3 - Scene** (1 byte - 17.001 DPT_SceneNumber)
- 105 - Output 4 - Scene** (1 byte - 17.001 DPT_SceneNumber)

For configuration see section: [Scene](#).

* Default value

Parameter	Description	Value
Preset	The Preset tab and the associated parameters and objects are: Hidden. Displayed for 1 Preset object. Displayed for 2 Preset objects.	Not active* Active with preset 1-level object Active with preset 2-level objects

Note: When the value of this parameter changes, the associated parameters and group addresses are deleted.

Preset 1 communication Objets

- 13 - Output 1 - Preset 1 (1 bit - 1.022 DPT_Scene_AB)
- 44 - Output 2 - Preset 1 (1 bit - 1.022 DPT_Scene_AB)
- 75 - Output 3 - Preset 1 (1 bit - 1.022 DPT_Scene_AB)
- 106 - Output 4 - Preset 1 (1 bit - 1.022 DPT_Scene_AB)

Preset 2 communication Objets

- 14 - Output 1 - Preset 2 (1 bit - 1.022 DPT_Scene_AB)
- 45 - Output 2 - Preset 2 (1 bit - 1.022 DPT_Scene_AB)
- 76 - Output 3 - Preset 2 (1 bit - 1.022 DPT_Scene_AB)
- 107 - Output 4 - Preset 2 (1 bit - 1.022 DPT_Scene_AB)

For configuration see section: [Preset](#).

Parameter	Description	Value
Lock-up	The Lock-up tab and the associated parameters and objects are: Hidden. Displayed for 1 lock-up object. Displayed for 2 lock-up objects.	Not active* 1 lock-up object 2 lock-up objects

Lock-up 1 communication objects

- 17 - Output 1 - Lock-up 1 (1 bit - 1.003 DPT_Enable)
- 48 - Output 2 - Lock-up 1 (1 bit - 1.003 DPT_Enable)
- 79 - Output 3 - Lock-up 1 (1 bit - 1.003 DPT_Enable)
- 110 - Output 4 - Lock-up 1 (1 bit - 1.003 DPT_Enable)

Lock-up 2 communication objects

- 18 - Output 1 - Lock-up 2 (1 bit - 1.003 DPT_Enable)
- 49 - Output 2 - Lock-up 2 (1 bit - 1.003 DPT_Enable)
- 80 - Output 3 - Lock-up 2 (1 bit - 1.003 DPT_Enable)
- 111 - Output 4 - Lock-up 2 (1 bit - 1.003 DPT_Enable)

For configuration see section: [Lock-up](#).

* Default value

Parameter	Description	Value
Priority	The Priority tab and the associated parameters and objects are: Hidden. Displayed.	Not active* Active

The device responds to telegrams received via the **Priority** object, as given in the following table:

Telegram received by the priority operation object		Status of the outputs
Bit 1	Bit 2	
0	0	End of the priority
0	1	End of the priority
1	0	Priority OFF
1	1	Priority ON

Communication objects:

- [20 - Output 1 - Priority](#) (2 bit - 2.002 DPT_Bool_Control)
- [51 - Output 2 - Priority](#) (2 bit - 2.002 DPT_Bool_Control)
- [82 - Output 3 - Priority](#) (2 bit - 2.002 DPT_Bool_Control)
- [113 - Output 4 - Priority](#) (2 bit - 2.002 DPT_Bool_Control)

For configuration see section: [Priority](#).

Parameter	Description	Value
Hours counter	The Hours counter tab and the associated parameters and objects are: Hidden. Displayed.	Not active* Active

A telegram can be transmitted via the **Hours counter setpoint reached** object, in accordance with a programmable setpoint.

It is also possible to reset the count value via a 1 signal on the **Reset hours counter value** object.

Communication objects:

- [22 - Output 1 - Hours counter value \(h\)](#) (2 byte - 7.007 DPT_Time(h))
- [53 - Output 2 - Hours counter value \(h\)](#) (2 byte - 7.007 DPT_Time(h))
- [84 - Output 3 - Hours counter value \(h\)](#) (2 byte - 7.007 DPT_Time(h))
- [115 - Output 4 - Hours counter value \(h\)](#) (2 byte - 7.007 DPT_Time(h))

- [23 - Output 1 - Reset hours counter value](#) (1 bit - 1.003 DPT_Enable)
- [54 - Output 2 - Reset hours counter value](#) (1 bit - 1.003 DPT_Enable)
- [85 - Output 3 - Reset hours counter value](#) (1 bit - 1.003 DPT_Enable)
- [116 - Output 4 - Reset hours counter value](#) (1 bit - 1.003 DPT_Enable)

- [24 - Output 1 - Hours counter setpoint reached](#) (1 bit - 1.011 DPT_State)
- [55 - Output 2 - Hours counter setpoint reached](#) (1 bit - 1.011 DPT_State)
- [86 - Output 3 - Hours counter setpoint reached](#) (1 bit - 1.011 DPT_State)
- [117 - Output 4 - Hours counter setpoint reached](#) (1 bit - 1.011 DPT_State)

For configuration see section: [Hours counter](#).

* Default value

Parameter	Description	Value
Notifications	The Notification tab and the associated parameters and objects are: Hidden. Displayed.	Not active* Active

For configuration see section: [Notifications](#).

3.7.2 ON/OFF timings function

Outputs 1-4: Function selection	Delays for ON/OFF objects	Switching and tripping delay
- O1-4: Manual mode	Switching delay	00:03:00 hh:mm:ss
- O1-4: Status indications	Tripping delay	00:03:00 hh:mm:ss
- Output 1	Timer/toggle switch changeover for object ON/OFF	<input type="radio"/> Not active <input checked="" type="radio"/> Active
Output 1: Function selection	Timer toggle change over duration	01:00:00 hh:mm:ss
- O1: ON/OFF object timings	Additional time limited toggle switch function	<input type="radio"/> Not active <input checked="" type="radio"/> Active
+ Output 2	Time limited toggle switch duration	01:00:00 hh:mm:ss
+ Output 3		
+ Output 4		

3.7.2.1 Delays for ON/OFF objects

Parameter	Description	Value
Delays for ON/OFF objects	The parameters for time-delayed switching of the outputs are: Hidden. Displayed for Switching delay. Displayed for Tripping delay. Displayed for Switching and tripping delay.	Not active* Switching delay Tripping delay Switching and tripping delay

* Default value

Switching delay: Allows the configuration of a delay between the switch-on command and the switching of the output contact.

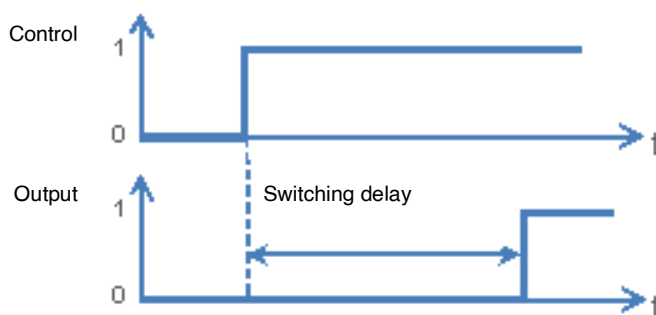

Tripping delay: Allows the configuration of a delay between the switch-off command and the switching of the output contact.

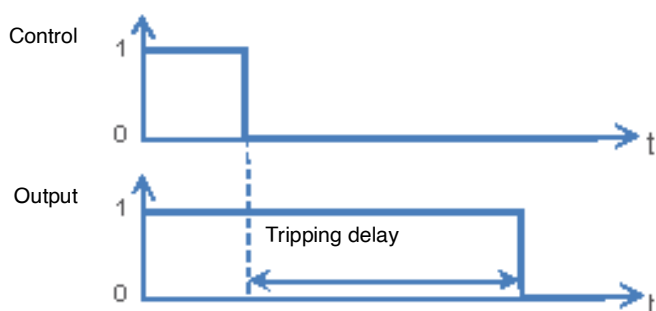

Switching and tripping delay: Allows the configuration of a delay between the switch-on command and the switching of the output contact, as well as between the switch-off command and the switching of the output contact.

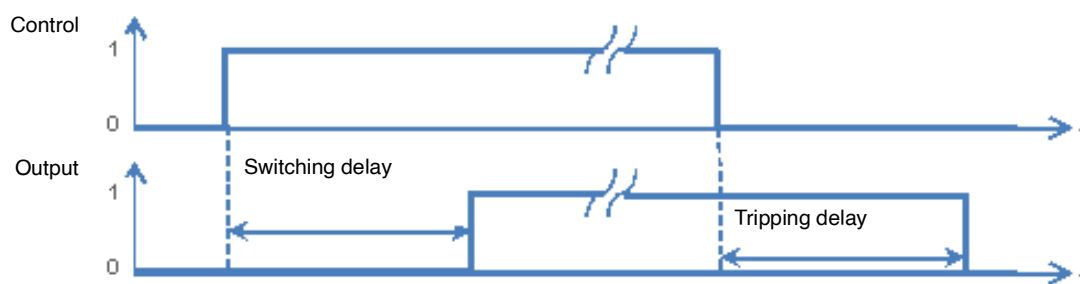

Parameter	Description	Value
Switching delay	This parameter defines the delay between the switch-on command and the switching of the output contact.	00h00m00s to 23h59m59s (00h03m00s*)

Note: The smallest executable time is 1 second.

*Note: This parameter is only visible if the **Delays for ON/OFF** objects parameter has the following value: **Switching delay** or **Switching and tripping delay**.*

Parameter	Description	Value
Tripping delay	This parameter defines the delay between the switch-off command and the switching of the output contact.	00h00m00s to 23h59m59s (00h03m00s*)

Note: The smallest executable time is 1 second.

*Note: This parameter is only visible if the **Delays for ON/OFF** objects parameter has the following value: **Tripping delay** or **Switching and tripping delay**.*

* Default value

3.7.2.2 Timer/toggle switch changeover for object ON/OFF

This function switches the output channels between toggle switch and timer mode for the **ON/OFF** object.

Example: Switching function daytime and Time-limited OFF function at night.

During the day, the button is used as a switch. In the evenings, the button is used as a time-limited OFF switch, so that the light will turn off automatically.

Parameter	Description	Value
ON/OFF	The parameters for a switch-over between toggle switch and timer modes for the ON/OFF object are: Hidden. Displayed.	Not active* Active

- If the **Timer/toggle switch changeover** object receives the value 1, the Toggle-switch mode function is activated. The ON/OFF switching of the output is performed as usual via the **ON/OFF** object.
- If the **Timer/toggle switch changeover** object receives the value 0, the Timer mode function is activated.
 - If the **ON/OFF** object receives the value 1, the output is switched ON. After expiry of a configurable time, the output is automatically switched OFF.
 - If the **ON/OFF** object receives the value 0, the output is switched OFF.

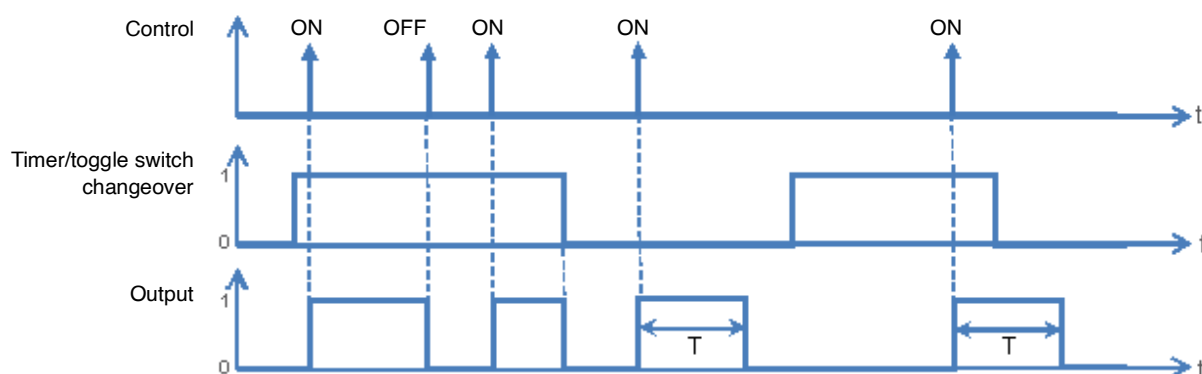

- Communication objects:
- 6 - Output 1 - Timer/toggle switch changeover (1 bit - 1.001 DPT_Switch)**
 - 37 - Output 2 - Timer/toggle switch changeover (1 bit - 1.001 DPT_Switch)**
 - 68 - Output 3 - Timer/toggle switch changeover (1 bit - 1.001 DPT_Switch)**
 - 99 - Output 4 - Timer/toggle switch changeover (1 bit - 1.001 DPT_Switch)**

Parameter	Description	Value
Periodicity	This parameter sets the length of the timer operation, if this is activated.	1 hours: 0 to 23 h 0 minutes: 0 to 59 min 0 seconds: 0 to 59 s

Note: The smallest executable time is 1 second.

*Note: This parameter is only visible if the **Timer/toggle switch changeover parameter for the ON/OFF object** has the following value: **Active**.*

* Default value

3.7.2.3 Time limited toggle switch

The Time-limited OFF function enables automatic switch off after a programmable Time-limited OFF time. The output works as a normal switch actuator but is switched off after a given time for security.

Example: Attic, the lighting can be switched normally but switches off after not more than 3 hours.

Parameter	Description	Value
Additional time limited toggle switch function	The parameters for setting the Time-limited OFF time are: Hidden. Displayed.	Not active* Active

Function diagram

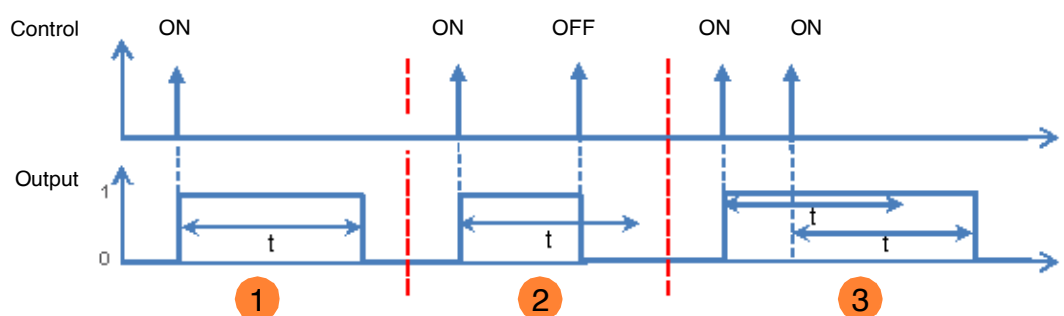

- 1 Emission of an ON command: The output which is at ON will switch to OFF on expiry of the Time-limited OFF time.
- 2 Emission of an ON command: The output switches to ON.
Emission of an OFF command before expiry of the Time-limited OFF time, t: The output switches to OFF.
- 3 Emission of an ON command: The output switches to ON.
Emission of an ON command before expiry of the Time-limited OFF time, t: The output remains at ON and the Time-limited OFF time, t, is re-started.

Communication objects:

- 7 - Output 1 - Time limited toggle switch (1 bit - 1.001 DPT_Switch)
- 38 - Output 2 - Time limited toggle switch (1 bit - 1.001 DPT_Switch)
- 69 - Output 3 - Time limited toggle switch (1 bit - 1.001 DPT_Switch)
- 100 - Output 4 - Time limited toggle switch (1 bit - 1.001 DPT_Switch)

Parameter	Description	Value
Periodicity	This parameter sets the length of the timer operation for the Time-limited toggle switch, if this is activated.	1 hours: 0 to 23 h 0 minutes: 0 to 59 min 0 seconds: 0 to 59 s

Note: The smallest executable time is 1 second.

*Note: This parameter is only visible if the **Additional time limited toggle switch function** parameter has the following value: **Active**.*

* Default value

3.7.3 Timer

The Timer function can switch a lighting circuit on or off for a configurable period. According to the selected operating mode of the timer, the output can be turned ON or OFF for a determined period of time. The timer may be interrupted before expiry of the delay time. A programmable Cut-OFF pre-warning announces the end of the delay time by a 1-second inversion of the output status.

Outputs 1-4: Function selection	Timer operation	<input checked="" type="radio"/> Value % <input type="radio"/> Blinking
- O1-4: Manual mode	Timer duration	00:03:00 hh:mm:ss
- O1-4: Status indications	Brightness value during timer (0-100%), last value (101)	101
- Output 1	Dimming speed for brightness value during timer	00:00:00 hh:mm:ss
Output 1: Function selection	Cut-OFF pre-warning	<input type="radio"/> Not active <input checked="" type="radio"/> Active
- O1: Timer	Cut off prewarning duration	00:00:30 hh:mm:ss
+ Output 2	Timer interruption	<input type="radio"/> No <input checked="" type="radio"/> Yes
+ Output 3	Timer retriggerability	<input type="radio"/> No <input checked="" type="radio"/> Yes
+ Output 4	Timer duration extension (10 first seconds)	Unlimited
+ Information	Timer duration modifiable through object	<input checked="" type="radio"/> Not active <input type="radio"/> Active

3.7.3.1 Timer operation

Parameter	Description	Value
Timer operation	When the timer is active, the output for the Timer duration is: Set to the stored value. Alternates between 2 brightness values.(Blink time is configurable via additional parameters.)	Value %* Blinking

Parameter	Description	Value
Timer duration	This parameter determines the timer duration.	00h00m00s to 23h59m59s (00h02m00s*)

Note: The smallest executable time is 1 second.

Parameter	Description	Value
Brightness value during timer (0-100%), last value (101)	During the timer duration, the output is set to the following value To the stored brightness value. To the last brightness value.	0 ... 100% 101*

Note: This parameter is only visible if the **Timer operation** parameter has the following value: **Value %**.

* Default value

Parameter	Description	Value
Dimming speed for brightness value during timer	This parameter defines the dimming speed for attaining the brightness value on activation of the timer function.	00h00m00s to 23h59m59s (00h00m00s*)

Note: This parameter is only visible if the **Timer operation** parameter has the following value: **Value %**.

Operating principle of the blink function:

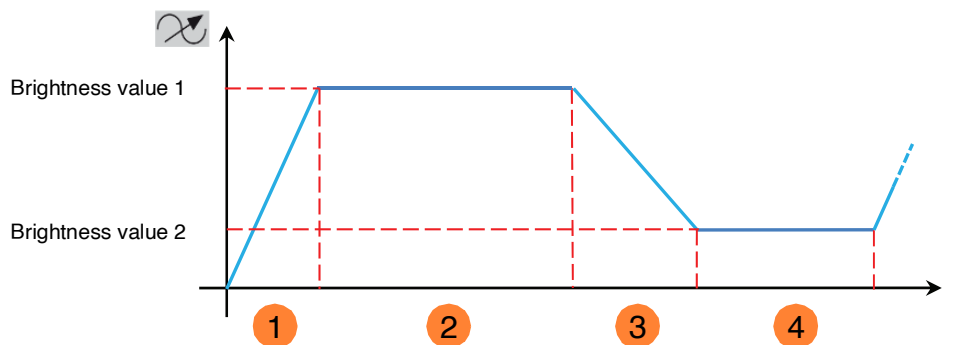

- ① Dimming speed for brightness value 1
- ② Brightness value 1 duration
- ③ Dimming speed for brightness value 2
- ④ Brightness value 2 duration

Parameter	Description	Value
Brightness val. 1 during blink. (0-100%), last value (101)	Brightness value 1 during Blinking corresponds To the stored brightness value. To the last brightness value.	0 ... 100% 101*

Note: This parameter is only visible if the **Timer operation** parameter has the following value: **Blinking**.

Parameter	Description	Value
Duration brightness value 1 during blinking (s)	Brightness value 1 during blinking is set for the following time.	5 seconds : 5 to 240 s

Note: This parameter is only visible if the **Timer operation** parameter has the following value: **Blinking**.

Parameter	Description	Value
Dimming speed for brightness value * during blinking	This parameter defines the dimming speed for attaining brightness value 1 during blinking.	0 seconds : 0 to 240 s

Note: This parameter is only visible if the **Timer operation** parameter has the following value: **Blinking**.

Parameter	Description	Value
Brightness val. 2 during blink. (0-100%), last value (101)	Brightness value 2 during Blinking corresponds To the stored brightness value. To the last brightness value.	0 ... 100% 101*

Note: This parameter is only visible if the **Timer operation** parameter has the following value: **Blinking**.

Note: If Brightness value 1 and Brightness value 2 are set to maintain the output value at 101, no blinking will be detectable.

* Default value

Parameter	Description	Value
Duration brightness value 2 during blinking (s)	Brightness value 2 during blinking is set for the following time.	5 seconds: 5 to 240 s

Note: This parameter is only visible if the **Timer operation** parameter has the following value: **Blinking**.

Parameter	Description	Value
Dimming speed for brightness value 2 during blinking	This parameter defines the dimming speed for attaining brightness value 2 during blinking.	0 seconds: 0 to 240 s

Note: This parameter is only visible if the **Timer operation** parameter has the following value: **Blinking**.

Parameter	Description	Value
Output status during blinking function	When the switch actuator is blinking, the Status indication ON/OFF object sends: The value, 1 = ON. The value, 0 = OFF. Alternating values depending on the current brightness value. Brightness value = 0, Status indication = 0 Brightness value > 0, Status indication = 1	ON* OFF ON/OFF

Note: This parameter is only visible if the **Timer operation** parameter has the following value: **Blinking**.

3.7.3.2 Cut-OFF pre-warning

Parameter	Description	Value
Cut-OFF pre-warning	Before expiry of the timer delay there is: No warning. A warning by dividing the lighting level by 2 during 1 s. The lead time of this warning can be set.	Not active Active*

Parameter	Description	Value
Periodicity	This parameter determines the lead time of the cut-OFF pre-warning.	00h00m00s to 23h59m59s (00h00m30s*)

Note: The smallest executable time is 1 second.

Note: This parameter is only visible if the **Cut-OFF pre-warning** parameter has the following value: **Active**.

Note: If the lead time of the cut-OFF pre-warning is greater than the duration of the timer, the cut-OFF pre-warning is not triggered.

3.7.3.3 Configuration

Parameter	Description	Value
Timer interruption	On receiving the value 0 on the Timer communication object, the timing is: Interrupted. Not interrupted.	Yes* No

* Default value

Parameter	Description	Value
Timer retriggerability	The parameter Timer duration extension (10 first seconds) is: Hidden. Displayed.	No Yes*

Parameter	Description	Value
Timer duration extension (10 first seconds)	If, during the first 10 seconds of the timer duration, multiple commands with the value 1 are received on the Timer communication object, it is: Multiplied unlimited times. Multiplied a maximum of 1x. Multiplied a maximum of 2x. Multiplied a maximum of 3x. Multiplied a maximum of 4x. Multiplied a maximum of 5x.	Unlimited* 1-time duration extension 2-time duration extension 3-time duration extension 4-time duration extension 5-time duration extension

Parameter	Description	Value
Timer duration modifiable through object	The Timer duration communication object is: Hidden. Displayed, the timer duration can be transmitted via the bus.	Not active* Active

Communication objects:

- [11 - Output 1 - Timer duration \(3 byte - 10.001 DPT_TimeOfDay\)](#)
- [42 - Output 2 - Timer duration \(3 byte - 10.001 DPT_TimeOfDay\)](#)
- [73 - Output 3 - Timer duration \(3 byte - 10.001 DPT_TimeOfDay\)](#)
- [104 - Output 4 - Timer duration \(3 byte - 10.001 DPT_TimeOfDay\)](#)

3.7.4 Scene

Outputs 1-4: Function selection	Number of scenes used	8
- O1-4: Manual mode	Scenes memorisation by long key press	<input type="radio"/> Not active <input checked="" type="radio"/> Active
- O1-4: Status indications	Scenes memorisation acknowledgment (Output status inverted for 3s)	<input checked="" type="radio"/> Not active <input type="radio"/> Active
- Output 1		
Output 1: Function selection	Output status for scene 1	Not active
- O1: Scenes	Output status for scene 2	Not active
+ Output 2	Output status for scene 3	Not active
+ Output 3	Output status for scene 4	Not active
+ Output 4	Output status for scene 5	Not active
+ Information	Output status for scene 6	Not active
	Output status for scene 7	Not active
	Output status for scene 8	Not active
	Brightness val. 1 during blink.(0-100%), last value (101)	100
	Duration brightness value 1 during blinking (s)	5
	Dimming speed for brightness value 1 during blinking (s)	0
	Brightness val. 2 during blink.(0-100%), last value (101)	101
	Duration brightness value 2 during blinking (s)	5
	Dimming speed for brightness value 2 during blinking (s)	0
	Output status during blinking function	ON

* Default value

Operating principle of the scenes:

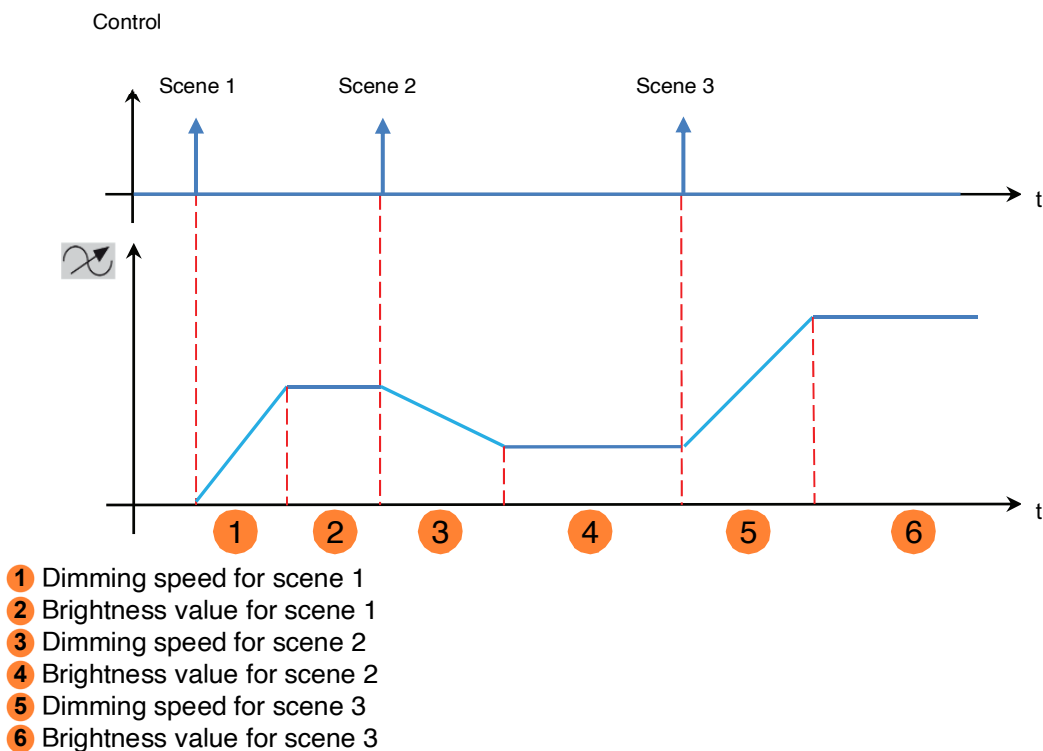

Parameter	Description	Value
Number of scenes used	This parameter determines the number of scenes used.	8* - 16 - 24 - 32 - 48 - 64

Note: If the Scene number received on the Scene object is greater than the maximum number of scenes, the status of the output remains unchanged.

Parameter	Description	Value
Scenes memorisation by very long key press	This parameter allows learning and storing of a scene by, for example, a long press (> 5 seconds) of the corresponding push button.	Not active Active*

Learning and storing scenes

This process is used to change and store a scene. For example, by locally pressing the key in the room or by emission of the values from a visualization.

To access and store scenes, the following values must be sent:

Scene number	Access scene (Object value: 1 byte)	Store scene (Object value: 1 byte)
1 - 64	= Scene number - 1	= Scene number + 128
Example		
1	0	128
2	1	129
3	2	130
...	...	
64	63	191

* Default value

Here is the scene memorisation for local switches, for example.

- Activate scene by briefly pressing the transmitter that starts it.
- The outputs (lights, shutters, etc.) are set in the desired state using the usual local control devices (buttons, remote control, etc.).
- Memorise the status of the outputs with a press greater than 5 seconds long on the transmitter that starts the scene. The memorisation can be displayed by short-term activation of the outputs.

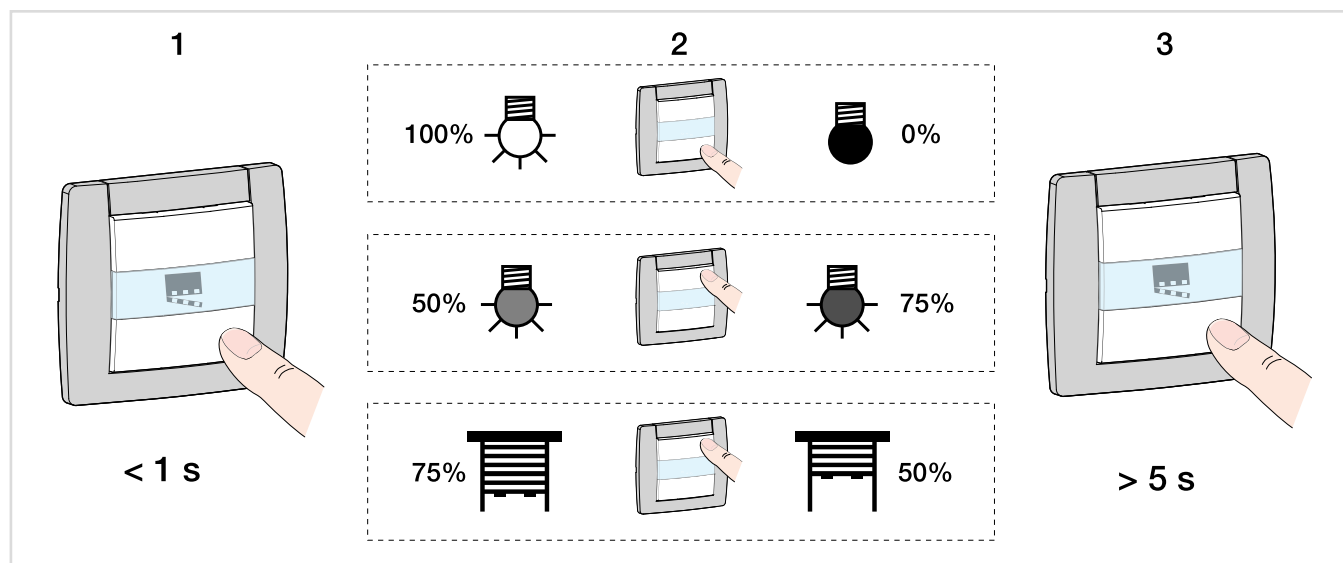

Parameter	Description	Value
Scenes memorisation acknowledgment	Memorisation of a scene is: Not acknowledged. Acknowledged by the output by a 3 second long inversion of the output status.	Not active* Active

Parameter	Description	Value
Output status for scene X	On activation of Scene X, the output is: Not changed. Selectively switched on. Selectively switched off. Alternated according to the Blink function. (Blink time is configurable via additional parameters.) Set to the stored value.	Not active* ON OFF Blinking Value %

X = 1 to 64

Note: Each output has up to 64 scenes available, in accordance with the **Number of scenes used** parameter.

Parameter	Description	Value
Brightness value for scene X (0-100%)	This parameter defines the brightness value that is applied to the output when Scene X is selected.	0 ... 100*

X = 1 to 64

Note: This parameter is only visible if the **Output status for scene X** parameter has the following value: **Value %**.

* Default value

Parameter	Description	Value
Dimming speed for scene X	This parameter defines the dimming speed for attaining the brightness value when Scene X is selected.	00h00m00s to 23h59m59s (00h00m00s*)

X = 1 to 64

Note: The smallest executable time is 1 second.

Note: This parameter is only visible if the **Output status for scene X** parameter has the following value: **Value %**.

Operating principle of the blink function:

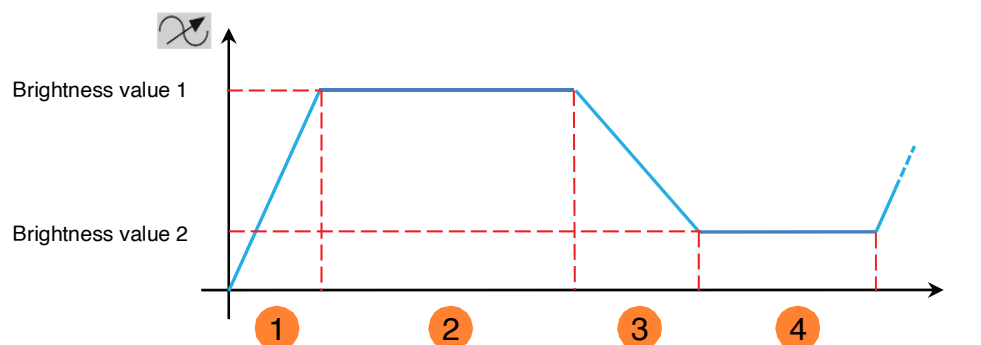

- ① Dimming speed for brightness value 1
- ② Brightness value 1 duration
- ③ Dimming speed for brightness value 2
- ④ Brightness value 2 duration

Parameter	Description	Value
Brightness val. 1 during blink. (0-100%), last value (101)	Brightness value 1 during Blinking corresponds To the stored brightness value. To the last brightness value.	0 ... 100% 101*

Note: This parameter applies to all scenes involving the respective output, which has the following value: **Blinking**.

Parameter	Description	Value
Duration brightness value 1 during blinking (s)	Brightness value 1 during blinking is set for the following time.	5 seconds: 5 to 240 s

Note: This parameter applies to all scenes involving the respective output, which has the following value: **Blinking**.

Parameter	Description	Value
Dimming speed for brightness value 1 during blinking (s)	This parameter defines the dimming speed for attaining brightness value 1 during blinking.	0 seconds: 0 to 240 s

Note: This parameter applies to all scenes involving the respective output, which has the following value: **Blinking**.

* Default value

Parameter	Description	Value
Brightness val. 2 during blink. (0-100%), last value (101)	Brightness value 2 during Blinking corresponds To the stored brightness value. To the last brightness value.	0 ... 100% 101*

*Note: This parameter applies to all scenes involving the respective output, which has the following value: **Blinking**.*

Parameter	Description	Value
Duration brightness value 2 during blinking (s)	Brightness value 2 during blinking is set for the following time.	5 seconds: 5 to 240 s

*Note: This parameter applies to all scenes involving the respective output, which has the following value: **Blinking**.*

Parameter	Description	Value
Dimming speed for brightness value 2 during blinking (s)	This parameter defines the dimming speed for attaining brightness value 2 during blinking.	0 seconds: 0 to 240 s

*Note: This parameter applies to all scenes involving the respective output, which has the following value: **Blinking**.*

Parameter	Description	Value
Output status during blinking function	When the switch actuator is blinking, the Status indication ON/OFF object sends: The value, 1 = ON. The value, 0 = OFF. Alternating values depending on the current brightness value. Brightness value = 0, Status indication = 0 Brightness value > 0, Status indication = 1	ON* OFF ON/OFF

*Note: This parameter applies to all scenes involving the respective output, which has the following value: **Blinking**.*

3.7.5 Preset

Outputs 1-4: Function selection	Preset authorization objects	<input type="radio"/> Not active <input checked="" type="radio"/> Active
- O1-4: Manual mode	Value of authorization preset 1 at initialization	Value before initialization
- O1-4: Status indications	Value of authorization preset 2 at initialization	Value before initialization
- Output 1	Polarity of Preset 1 authorization object	<input checked="" type="radio"/> 0 = Locked-up , 1 = Authorized <input type="radio"/> 0 = Authorized, 1 = Locked-up
Output 1: Function selection	Polarity of Preset 2 authorization object	<input checked="" type="radio"/> 0 = Locked-up , 1 = Authorized <input type="radio"/> 0 = Authorized, 1 = Locked-up
- O1: Preset		
+ Output 2	Status if preset 1 object = 0	Scene number
+ Output 3	Scene for preset 1 = 0	1
+ Output 4	Status if preset 1 object = 1	Blinking
+ Information	Brightness val. 1 during blink.(0-100%), last value (101)	100
	Duration brightness value 1 during blinking (s)	5
	Dimming speed for brightness value 1 during blinking (s)	0
	Brightness val. 2 during blink.(0-100%), last value (101)	100
	Duration brightness value 2 during blinking (s)	5
	Dimming speed for brightness value 2 during blinking (s)	0
	Output status during blinking function	ON
	Status if preset 2 object = 0	Maintain status
	Status if preset 2 object = 1	Maintain status

The Preset function is used to switch an output into various predefined states. The Preset function is activated via an object in 1-bit format.

Principle of Preset authorization:

The parameters are set as follows:

- Polarity of Preset 1 authorization object: 0 = Locked-up, 1 = Authorized.
- Polarity of Preset 2 authorization object: 0 = Locked-up, 1 = Authorized.
- Status if preset 1 object = 0: ON.
- Status if preset 1 object = 1: OFF.
- Status if preset 2 object = 0: Scene 1.
- Status if preset 2 object = 1: Scene 2.

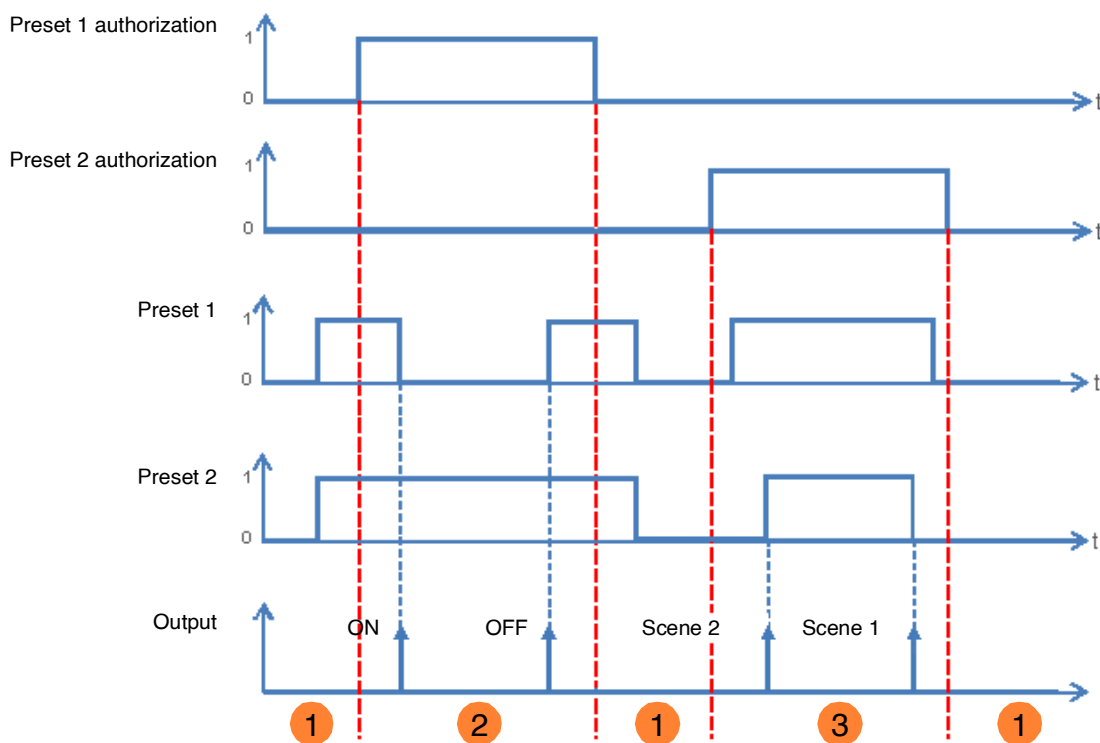

- ❶ The preset inputs have no influence on the output.
- ❷ The commands from Preset 1 are executed.
- ❸ The commands from Preset 2 are executed.

Note: The commands from the Preset will not be executed immediately after authorization, but only when the value of the Preset changes.

Parameter	Description	Value
Preset authorization objects	The Preset 1 authorization communication object and the related parameters are: Hidden. Displayed. This object allows the authorization or lock-up of the Preset 1 function via a KNX telegram.	Not active* Active

*Note: The number of available Preset objects is dependent on the **Preset** parameter. A maximum of two of these objects can be available.*

Communication objects: [15 - Output 1 - Preset 1 authorization](#) (1 bit - 1.003 DPT_Enable)
[46 - Output 2 - Preset 1 authorization](#) (1 bit - 1.003 DPT_Enable)
[77 - Output 3 - Preset 1 authorization](#) (1 bit - 1.003 DPT_Enable)
[108 - Output 4 - Preset 1 authorization](#) (1 bit - 1.003 DPT_Enable)

Communication objects: [16 - Output 1 - Preset 2 authorization](#) (1 bit - 1.003 DPT_Enable)
[47 - Output 2 - Preset 2 authorization](#) (1 bit - 1.003 DPT_Enable)
[78 - Output 3 - Preset 2 authorization](#) (1 bit - 1.003 DPT_Enable)
[109 - Output 4 - Preset 2 authorization](#) (1 bit - 1.003 DPT_Enable)

Note: The parameters and objects are identical for Preset 2 ; Only the terms will be adjusted.

* Default value

Parameter	Description	Value
Value of authorization preset 1 at initialization	On initialization of the device after a download or after return of the bus power, the value of the Preset 1 authorization object is: Set to 0. Set to 1. Set according to the value of the logic input before the initialization occurred.	0 1 Value before initialization*

Note: This parameter is only visible if the **Preset authorization objects** parameter has the following value: **Active**.

Parameter	Description	Value
Polarity of Preset 1 authorization object	On receipt of a value on the Preset 1 authorization object, Preset 1 : Locked-up on object value 1. Locked-up on object value 0.	0 = Locked-up, 1 = Authorized* 0 = Authorized, 1 = Locked-up

Note: This parameter is only visible if the **Preset authorization objects** parameter has the following value: **Active**.

Parameter	Description	Value
Status if preset 1 object = 0	On receipt of the value 0 on the Preset 1 object, the output is: Not changed. Is switched to the opposite status. Selectively switched on. Selectively switched off. Set to the stored value. Set to a scene value. Set in blinking mode. Switched to the status that was active before last receiving the value 1 on the Preset 1 object.	Maintain status* Inversion ON OFF Value % Scene number Blinking Status before preset 1 = 1

Parameter	Description	Value
Brightness value if object preset 1 = 0 (0-100%)	This parameter determines the brightness value which will be applied to the respective output if the Preset 1 object receives the value 0.	0 ... 100*

Note: This parameter is only visible if the **Status if preset 1 object = 0** parameter has the following value: **Value %**.

Parameter	Description	Value
Dimming speed for brightness value during preset 1 = 0	This parameter determines the dimming speed to attain the brightness value of the respective output if the Preset 1 object receives the value 0.	1 hours: 0 to 23 h 0 minutes: 0 to 59 min 0 seconds: 0 to 59 s

Note: This parameter is only visible if the **Status if preset 1 object = 0** parameter has the following value: **Value %**.

* Default value

Parameter	Description	Value
Scene for preset 1 = 0	This parameter determines the value of the scene if: The Preset 1 object has value 0. The Status if preset 1 object = 0 object has the scene value.	Scene 1 ... 64 Default value: 1

*Note: This parameter is only visible if the **Status if preset 1 object = 0** parameter has the following value: **Scene number**.*

Parameter	Description	Value
Status if preset 1 object = 1	On receipt of the value 1 on the Preset 1 object, the output is: Not changed. Is switched to the opposite status. Selectively switched on. Selectively switched off. Set to the stored value. Set to a scene value. Set in blinking mode. Switched to the status that was active before last receiving the value 1 on the Preset 1 object.	Maintain status* Inversion ON OFF Value % Scene number Blinking Status before preset 1 = 0

Parameter	Description	Value
Brightness value if object preset 1 = 1 (0-100%)	This parameter determines the brightness value which will be applied to the respective output if the Preset 1 object receives the value 1.	0 ... 100*

*Note: This parameter is only visible if the **Status if preset 1 object = 1** parameter has the following value: **Value %**.*

Parameter	Description	Value
Dimming speed for brightness value during preset 1 = 1	This parameter determines the dimming speed to attain the brightness value of the respective output if the Preset 1 object receives the value 1.	00h00m00s to 23h59m59s (00h00m00s*)

*Note: This parameter is only visible if the **Status if preset 1 object = 1** parameter has the following value: **Value %**.*

Parameter	Description	Value
Scene number for preset 1 = 1	This parameter determines the value of the scene if: The Preset 1 object has value 1. The Status if preset 1 object = 1 object has the scene value.	Scene 1 ... 64 Default value: Scene 1

*Note: This parameter is only visible if the **Status if preset 1 object = 1** parameter has the following value: **Scene number**.*

If the **Status on preset 1 object = 0** parameter, **Status on preset 1 = 1 object**, **Status on preset 2 = 0 object** and **Status on preset 2 = 1 object** have the value **Blinking**, the Blink parameter is configured as follows.

Operating principle of the blink function:

* Default value

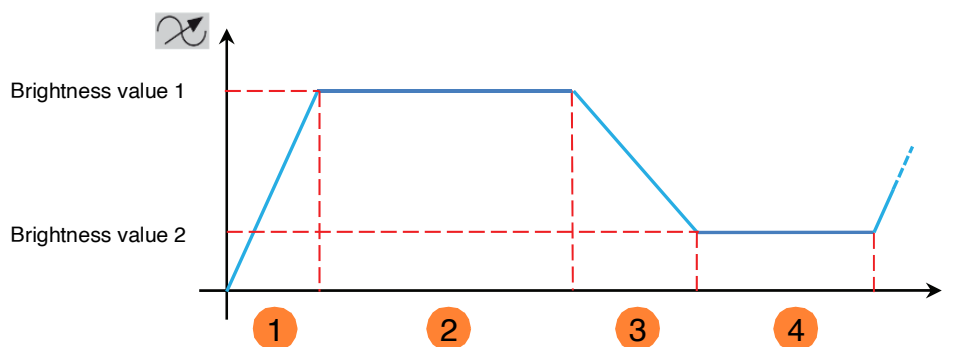

- 1 Dimming speed for brightness value 1
- 2 Brightness value 1 duration
- 3 Dimming speed for brightness value 2
- 4 Brightness value 2 duration

Parameter	Description	Value
Brightness val. 1 during blink. (0-100%), last value (101)	Brightness value 1 during Blinking corresponds To the stored brightness value. To the last brightness value.	0 ... 100% 101*

Note: This parameter is only visible if the **Status if preset 1 object = 0** parameter or the **Status if preset 1 object = 1** parameter has the following value: **Blinking**.

Parameter	Description	Value
Duration brightness value 1 during blinking (s)	Brightness value 1 during blinking is set for the following time.	5 seconds: 5 to 240 s

Note: This parameter is only visible if the **Timer operation** parameter has the following value: **Blinking**.

Parameter	Description	Value
Dimming speed for brightness value 1 during blinking (s)	This parameter defines the dimming speed for attaining brightness value 1 during blinking.	0 seconds: 0 to 240 s

This parameter is only visible if the **Status if preset 1 object = 0** parameter or the **Status if preset 1 object = 1** parameter has the following value: **Blinking**.

Parameter	Description	Value
Brightness val. 2 during blink. (0-100%), last value (101)	Brightness value 2 during Blinking corresponds To the stored brightness value. To the last brightness value.	0 ... 100% 101*

Note: This parameter is only visible if the **Status if preset 1 object = 0** parameter or the **Status if preset 1 object = 1** parameter has the following value: **Blinking**.

Parameter	Description	Value
Duration brightness value 2 during blinking (s)	Brightness value 2 during blinking is set for the following time.	5 seconds: 5 to 240 s

Note: This parameter is only visible if the **Status if preset 1 object = 0** parameter or the **Status if preset 1 object = 1** parameter has the following value: **Blinking**.

* Default value

Parameter	Description	Value
Dimming speed for brightness value 2 during blinking (s)	This parameter defines the dimming speed for attaining brightness value 2 during blinking.	0 seconds: 0 to 240 s

This parameter is only visible if the **Status if preset 1 object = 0** parameter or the **Status if preset 1 object = 1** parameter has the following value: **Blinking**.

Parameter	Description	Value
Output status during blinking function	When the switch actuator is blinking, the Status indication ON/OFF object sends: The value, 1 = ON. The value, 0 = OFF. Alternating values depending on the current brightness value. Brightness value = 0, Status indication = 0 Brightness value > 0, Status indication = 1	ON* OFF ON/OFF

*Note: This parameter is only visible if the **Status if preset 1 object = 0** parameter or the **Status if preset 1 object = 1** parameter has the following value: **Blinking**.*

3.7.6 Lock-up

Outputs 1-4: Function selection	Lock-up type	<input checked="" type="radio"/> Output lock-up <input type="radio"/> Object lock-up
- O1-4: Manual mode	Lock-up duration	<input type="radio"/> Time limited <input checked="" type="radio"/> Permanently
- O1-4: Status indications		
- Output 1	Polarity of lock-up object 1	<input checked="" type="radio"/> 0 = Lock-up deactivated, 1 = Lock-up activated <input type="radio"/> 0 = Lock-up activated, 1 = Lock-up deactivated
Output 1: Function selection	Polarity of lock-up object 2	<input checked="" type="radio"/> 0 = Lock-up deactivated, 1 = Lock-up activated <input type="radio"/> 0 = Lock-up activated, 1 = Lock-up deactivated
- O1: Lock-up		
+ Output 2	Priority between lock-up 1 and lock-up 2	Lock-up 1 > Lock-up 2
+ Output 3	Status during lock-up 1	Maintain status
+ Output 4	Status during lock-up 2	Maintain status
+ Information	Status after lock-up function 1	Maintain status
	Status after lock-up function 2	Maintain status
	Activation of lock-up status object	<input type="radio"/> Not active <input checked="" type="radio"/> Active
	Polarity	<input checked="" type="radio"/> 0 = Lock-up deactivated, 1 = Lock-up activated <input type="radio"/> 0 = Lock-up activated, 1 = Lock-up deactivated
	Emission	On status change and periodically
	Periodicity	00:10:00 hh:mm:ss

The Lock-up function is used to lock the output in a predefined state.

Priority: Manual mode > Priority > **Lock-up** > Basic function.

The Lock-up prevents actuation until an unlock command has been received.

The Lock-up duration can be set.

* Default value

Parameter	Description	Value
Lock-up type	<p>The Lock-up acts:</p> <p>Directly on the switch actuator. As long as the Lock-up is active, the output can only be controlled by higher priority commands.</p> <p>On selected communication objects. As long as the Lock-up is active, the output can only be controlled via specific selectable objects.</p>	<p>Output lock-up*</p> <p>Object lock-up</p>

Parameter	Description	Value
Lock-up duration	<p>The duration of the Lock-up is</p> <p>Not time limited, the lock-up is only authorized by means of a telegram on Lock-up 1 object.</p> <p>Is active for a limited time, the control of the output is authorized after expiry of this time.</p>	<p>Permanently*</p> <p>Time limited</p>

Parameter	Description	Value
Periodicity	This parameter determines the activation time of the Lock-up.	00h00m00s to 23h59m59s (00h15m00s*)

Note: The smallest executable time is 1 second.

*Note: This parameter is only visible if the **Lock-up duration** parameter has the following value: **Time limited**.*

Parameter	Description	Value
Polarity of lock-up object 1	<p>On receipt of a value on the Lock-up 1 object, the lock-up:</p> <p>Locked-up on object value 1. Is deactivated on object value 0.</p> <p>Locked-up on object value 0. Is deactivated on object value 1.</p>	<p>0 = Lock-up deactivated, 1 = Lock-up activated*</p> <p>0 = Lock-up activated, 1 = Lock-up deactivated</p>

Note: The parameters and objects are identical for Lock-up 2 ; Only the terms will be adjusted.

Parameter	Description	Value
Priority between lock-up 1 and lock-up 2	<p>The priority between lock-up 1 and lock-up 2 is set as follows:</p> <p>Lock-up 1 has priority over lock-up 2.</p> <p>Lock-up 2 has priority over lock-up 1.</p> <p>Lock-up 1 and lock-up 2 have the same priority.</p>	<p>Lock-up 1 > Lock-up 2*</p> <p>Lock-up 1 < Lock-up 2</p> <p>Lock-up 1 = Lock-up 2</p>

*Note: This parameter is only visible if the **Lock-up** parameter has the following value: **Active with 2 lock-up objects**.*

Note: The priority of the Lock-up always functions in the same way, independently of the lock-up type (Output lock-up or object lock-up).

* Default value

Operating principle of the priorities:

If Lock-up 1 > Lock-up 2

Active lock-up	Activation order of Lock-up 1	Activation order of Lock-up 2
None	Lock-up 1 is activated	Lock-up 2 is activated
Lock-up 1	Lock-up 1 remains active	Despite the activation order of Lock-up 2, Lock-up 1 remains activated
Lock-up 2	Lock-up 1 is activated	Lock-up 2 remains active

If Lock-up 1 = Lock-up 2

Active lock-up	Activation order of Lock-up 1	Activation order of Lock-up 2
None	Lock-up 1 is activated	Lock-up 2 is activated
Lock-up 1	Lock-up 1 remains active	Lock-up 2 is activated
Lock-up 2	Lock-up 1 is activated	Lock-up 2 remains active

If Lock-up 1 < Lock-up 2

Active lock-up	Activation order of Lock-up 1	Activation order of Lock-up 2
None	Lock-up 1 is activated	Lock-up 2 is activated
Lock-up 1	Lock-up 1 remains active	Lock-up 2 is activated
Lock-up 2	Despite the activation order of Lock-up 1, Lock-up 2 remains activated	Lock-up 2 remains active

Parameter	Description	Value
Status during lock-up 1	<p>If the Lock-up type is set to Output lock-up, on activation of the lock-up the output will:</p> <p>Not changed.</p> <p>Switch to the opposite status.</p> <p>Selectively switched on.</p> <p>Selectively switched off.</p> <p>Set to the stored value.</p>	<p>Maintain status*</p> <p>Inversion</p> <p>ON</p> <p>OFF</p> <p>Value %</p>

Note on inversion: If the brightness value is greater than or equal to 1%, the value goes to 0%. If the brightness value is less than 1%, the value goes to 100%.

Note: The parameters and objects are identical for Lock-up 2 ; Only the terms will be adjusted.

Lock-up 1 authorizes object:

The parameters listed below allow the selection of the objects for controlling the output via the nevertheless active Lock-up.

*Note: These parameters are only visible if the **Lock-up type** parameter has the following value: **Object lock-up**.*

* Default value

Parameter	Objects concerned	Value
ON/OFF	ON/OFF	Yes No*
Scene	Scene	Yes No*
Timer	Timer	Yes No*
Timer/toggle switch changeover	Timer/toggle switch changeover	Yes No*
Time limited toggle switch	Time limited toggle switch	Yes No*
Preset 1	Preset 1	Yes No*
Preset 2	Preset 2	Yes No*

Note: The parameters and objects are identical for Lock-up 2 ; Only the terms will be adjusted.

Parameter	Description	Value
Status after lock-up function 1	<p>If the Lock-up type is set to Output lock-up, on cancellation of the lock-up the output will:</p> <p>Not changed.</p> <p>Switch to the opposite status.</p> <p>Selectively switched on.</p> <p>Selectively switched off.</p> <p>Set to the stored value.</p> <p>Return to the status that was active before the lock-up.</p> <p>Set to the status which would be active according to other communication objects had no lock-up taken place.</p>	<p>Maintain status*</p> <p>Inversion</p> <p>ON</p> <p>OFF</p> <p>Value %</p> <p>Status before lock-up 1</p> <p>Theoretical status without lock-up function 1</p>

Note on inversion: If the brightness value is greater than or equal to 1%, the value goes to 0%. If the brightness value is less than 1%, the value goes to 100%.

Note: The application of this parameter depends on the priority of the other active functions. If a function with higher priority is active, this parameter will not be enacted. In the case where two functions with the same priority are active, the parameter of the most recently switched off function is enacted.

Note: The parameters and objects are identical for Lock-up 2 ; Only the terms will be adjusted.

Parameter	Description	Value
Activation of lock-up status object	The Status indication lock-up communication object is hidden.	Not active*
	The Status indication lock-up communication object is displayed.	Active

* Default value

Communication objects:

- 19 - Output 1 - Status indication lock-up** (1 bit - 1.011 DPT_State)
- 50 - Output 2 - Status indication lock-up** (1 bit - 1.011 DPT_State)
- 91 - Output 3 - Status indication lock-up** (1 bit - 1.011 DPT_State)
- 112 - Output 4 - Status indication lock-up** (1 bit - 1.011 DPT_State)

Parameter	Description	Value
Polarity	The Status indication Lock-up communication object sends: 0 on deactivation of the lock-up. 1 on activation of the lock-up. 0 on activation of the lock-up. 1 on deactivation of the lock-up.	0 = Lock-up deactivated, 1 = Lock-up activated* 0 = Lock-up activated, 1 = Lock-up deactivated

Parameter	Description	Value
Emission	The Status indication lock-up communication object is sent: On activation and deactivation of the lock-up. Periodically after a configurable time. On activation and deactivation of the lock-up and periodically after a configurable time.	On status change* Periodically On status change and periodically

*Note: This parameter is only visible if the **Activation of Lock-up status object** parameter has the following value: **Active**.*

Parameter	Description	Value
Periodicity	This parameter determines the time between the individual transmissions of the Status indication lock-up object.	00h00m00s to 23h59m59s (00h10m00s*)

Note: The smallest executable time is 1 second.

*Note: This parameter is only visible if the **Emission** parameter has the following value: **Periodically** or **On status change and periodically**.*

3.7.7 Priority

Outputs 1-4: Function selection	Activation of priority status object	<input type="radio"/> Not active <input checked="" type="radio"/> Active
- O1-4: Manual mode	Polarity	<input checked="" type="radio"/> 0 = Not forced, 1 = Forced <input type="radio"/> 0 = Forced, 1 = Not forced
- O1-4: Status indications	Emission	On status change ▼
- Output 1	Status after priority	Maintain status ▼
Output 1: Function selection	Brightness value during priority (0-100%), last value (101)	100 ▲▼
- O1: Priority	Dimming speed for brightness value during priority	00:00:00 hh:mm:ss
+ Output 2		
+ Output 3		
+ Output 4		

The Priority is used to force the output into a predefined state.

Priority: Manual mode > **Priority** > Lock-up > Basic function.

No other command is taken into account when the Priority is active. Only by ending the Priority are other commands again permitted.

Parameter	Description	Value
Activation of priority status object	The Status indication priority communication object and related parameters are hidden.	Not active*
	The Status indication priority communication object and related parameters are displayed.	Active

Communication objects:

- [21 - Output 1 - Status indication priority \(1 bit - 1.011 DPT_State\)](#)
- [52 - Output 2 - Status indication priority \(1 bit - 1.011 DPT_State\)](#)
- [83 - Output 3 - Status indication priority \(1 bit - 1.011 DPT_State\)](#)
- [114 - Output 4 - Status indication priority \(1 bit - 1.011 DPT_State\)](#)

Parameter	Description	Value
Polarity	The Status indication priority communication object sends: 0 on deactivation of the Priority. 1 on activation of the Priority. 0 on activation of the Priority. 1 on deactivation of the Priority.	0 = Not forced, 1 = Forced* 0 = Forced, 1 = Not forced

*Note: This parameter is only visible if the **Activation of priority status object** parameter has the following value: **Active**.*

* Default value

Parameter	Description	Value
Emission	The Status indication priority communication object is sent: On activation and deactivation of the Priority. Periodically after a configurable time. On activation and deactivation of the Priority and periodically after a configurable time.	On status change* Periodically On status change and periodically

*Note: This parameter is only visible if the **Activation of priority status object** parameter has the following value: **Active**.*

Parameter	Description	Value
Periodicity	This parameter determines the time between the individual transmissions of the Status indication priority object.	00h00m00s to 23h59m59s (00h10m00s*)

Note: The smallest executable time is 1 second.

*Note: This parameter is only visible if the **Emission** parameter has the following value: **Periodically** or **On status change and periodically**.*

Parameter	Description	Value
Status after priority	At the end of the priority, the output is: Not changed. Switch to the opposite status. Selectively switched on. Selectively switched off. Set to the stored value. Switched back to the status before priority was activated. Switched to the status which would be active according to other communication objects if the priority had not taken place.	Maintain status* Inversion ON OFF Value % Status before priority Theoretical status without priority

Note on inversion: If the brightness value is greater than or equal to 1%, the value goes to 0%. If the brightness value is less than 1%, the value goes to 100%.

Note: The application of this parameter depends on the priority of the other active functions. If a function with higher priority is active, this parameter will not be enacted. In the case where two functions with the same priority are active, the parameter of the most recently switched off function is enacted.

Parameter	Description	Value
Brightness value after priority (0-100%)	This parameter defines the brightness value that is applied on the output after the end of priority.	0 ... 100*

*Note: This parameter is only visible if the **Status after priority** parameter has the following value: **Value %**.*

* Default value

Parameter	Description	Value
Dimming speed for brightness value after priority	This parameter defines the dimming speed for attaining the brightness value of the output after ending of the priority.	00h00m00s to 23h59m59s (00h00m00s*)

Note: This parameter is only visible if the **Status after priority** parameter has the following value: **Value %**.

Parameter	Description	Value
Brightness value during priority (0-100%), last value (101)	During the priority, the brightness value corresponds to: To the stored brightness value. To the last brightness value.	0 ... 100* 101

Parameter	Description	Value
Dimming speed for brightness value during priority	This parameter defines the dimming speed for attaining the brightness value of the output during the priority.	00h00m00s to 23h59m59s (00h00m00s*)

3.7.8 Hours counter

The Hours Counter function is used to count the overall operating time of an output in the ON or OFF state. The operating hours counter setpoint can be programmed and altered via an object.

Outputs 1-4: Function selection	Relay status for operating hours counter	<input type="radio"/> Opened <input checked="" type="radio"/> Closed
- O1-4: Manual mode	Hours counter direction	<input checked="" type="radio"/> Increment <input type="radio"/> Countdown
- O1-4: Status indications	Hours counter setpoint (h)	10000
- Output 1	Counter setpoint value modifiable through object	<input checked="" type="radio"/> Not active <input type="radio"/> Active
- O1: Hours counter	Hours counter objects unit	<input checked="" type="radio"/> Hours <input type="radio"/> Seconds
+ Output 2	Emission hours counter value	On status change and periodically
+ Output 3	Value interval (h)	100
+ Output 4	Periodicity	01:00:00 hh:mm:ss
+ Information	Object emission counter setpoint reached	On status change and periodically
	Periodicity	01:00:00 hh:mm:ss

Parameter	Description	Value
Relay status for operating hours counter	The hours counter runs if: The brightness value is > 0. The brightness value = 0.	Closed* Opened

* Default value

Parameter	Description	Value
Hours counter direction	The hours counter counts: Growing. Decreasing.	Increment* Countdown

Increment:

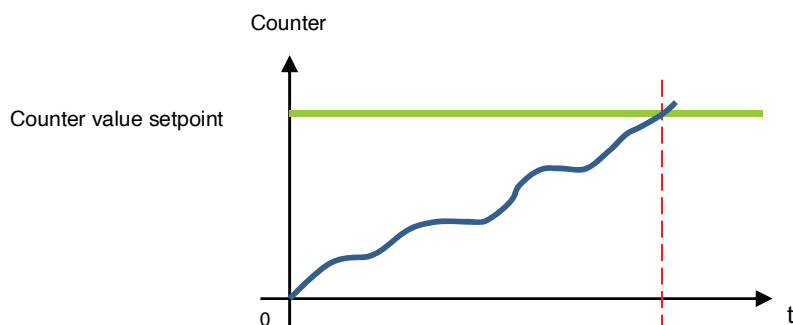

The counter starts to count up from the value 0. As soon as the counter setpoint (**Hours counter setpoint** object) is reached, the **Hours counter setpoint reached** object is set to 1 and sent to the bus.

Countdown:

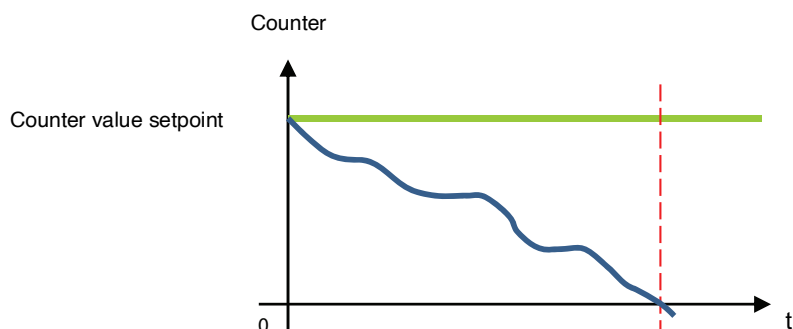

The counter starts to count down from the operating hours counter setpoint (**Hours counter setpoint** object). As soon as the counter reaches 0, the **Hours counter setpoint reached** is set to 1 and sent to the bus.

Parameter	Description	Value
Hours counter setpoint	This parameter determines the value of the hours counter.	1 ... 10000* ... 65535

An incrementing counter starts at 0 and counts up until it reaches the setpoint value.
A countdown counter starts to count at the setpoint value and counts down until it has arrived at 0.

Parameter	Description	Value
Counter setpoint value modifiable through object	The Hours counter setpoint communication object is hidden. The Hours counter setpoint communication object is displayed. The value can be changed via the KNX bus.	Not active* Active

* Default value

Communication objects: **25 - Output 1 - Hours counter setpoint (h)** (2 byte - 7.007 DPT_Time(h))
56 - Output 2 - Hours counter setpoint (h) (2 byte - 7.007 DPT_Time(h))
87 - Output 3 - Hours counter setpoint (h) (2 byte - 7.007 DPT_Time(h))
118 - Output 4 - Hours counter setpoint (h) (2 byte - 7.007 DPT_Time(h))

Parameter	Description	Value
Emission hours counter value	The Hours counter value communication object is sent: On each change. Periodically after a configurable time. On change and periodically after a configurable time.	On status change* Periodically On status change and periodically

Parameter	Description	Value
Value interval (h)	This parameter specifies the value interval (in hours) for the sending frequency of the Hours counter setpoint object.	1 ... 100* ... 65535 (hours)

*Note: If the value interval is 200 hours, then the **Hours counter setpoint** object is sent each time the Operating h. counter value is increased by 200 hours.*

*Note: This parameter is only visible if the **Emission hours counter value** parameter has the following value: **Periodically** or **On status change and periodically**.*

Parameter	Description	Value
Periodicity	This parameter determines the time between the individual transmissions of the Hours counter setpoint object.	00h00m00s to 23h59m59s (01h00m00s*)

Note: The smallest executable time is 1 second.

*Note: This parameter is only visible if the **Emission hours counter value** parameter has the following value: **Periodically** or **On status change and periodically**.*

Parameter	Description	Value
Object emission counter setpoint reached	The Hours counter setpoint reached communication object is sent: On reaching the counter setpoint. Periodically after a configurable time. On reaching the counter setpoint and periodically after a configurable time.	On status change Periodically* On status change and periodically

Parameter	Description	Value
Periodicity	This parameter determines the time between the individual transmissions of the Hours counter setpoint reached object.	1 hours: 0 to 23 h 0 minutes: 0 to 59 min 0 seconds: 0 to 59 s

Note: The smallest executable time is 1 second.

*Note: This parameter is only visible if the Object **Emission counter setpoint reached** parameter has the following value: **Periodically** or **On status change and periodically**.*

* Default value

3.7.9 Notifications

Outputs 1-4: Function selection	Activate all notifications	<input type="radio"/> Not active <input checked="" type="radio"/> Active
- O1-4: Manual mode	Object dimming mode	<input type="radio"/> Not active <input checked="" type="radio"/> Active
- O1-4: Status indications	Emission	On status change and periodically
Output 1	Periodicity	00:15:00 hh:mm:ss
Output 1: Function selection	Object overload	<input type="radio"/> Not active <input checked="" type="radio"/> Active
- O1: Notification	Emission	On status change
+ Output 2	Object shortcircuit	<input type="radio"/> Not active <input checked="" type="radio"/> Active
+ Output 3	Emission	On status change
+ Output 4		
+ Information	Object over voltage	<input type="radio"/> Not active <input checked="" type="radio"/> Active
	Emission	On status change
	Object over temperature	<input type="radio"/> Not active <input checked="" type="radio"/> Active
	Emission	On status change
	Object load default	<input type="radio"/> Not active <input checked="" type="radio"/> Active
	Emission	On status change

Parameter	Description	Value
Activate all notifications	All of the notifications and all of the associated parameters and objects are: Hidden. Displayed.	Not active* Active

3.7.9.1 Dimming mode

Parameter	Description	Value
Object dimming mode	This parameter is used to authorize the Dimming mode object . This object enables the dimming mode to be sent.	Not active* Active

Parameter	Description	Value
Emission	The Dimming mode communication object is sent: On switching manual mode on or off. Periodically after a configurable time. On switching manual mode on or off and periodically after a configurable time.	On status change* Periodically On status change and periodically

Note: This parameter is only visible if the **Object Dimming mode** parameter has the following value: **Active**.

* Default value

Parameter	Description	Value
Periodical emission delay	This parameter determines the time between the individual transmissions of the Dimming mode object.	00h00m00s to 23h59m59s (00h15m00s*)

Note: The smallest executable time is 1 second.

Note: This parameter is only visible if the **Emission** parameter has the following value: **Periodically** or **On status change and periodically**.

3.7.9.2 Overload

Parameter	Description	Value
Object overload	This parameter is used to authorize the Overload object . This object is used for notification of an overload on the output concerned, via the KNX bus. An overload arises, for example, when several lamps are connected to the output, exceeding its rated power.	Not active* Active

Communication objects:

- [27 - Output 1 - Overload \(1 bit - 1.005 DPT_Alarm\)](#)
- [58 - Output 2 - Overload \(1 bit - 1.005 DPT_Alarm\)](#)
- [89 - Output 3 - Overload \(1 bit - 1.005 DPT_Alarm\)](#)
- [120 - Output 4 - Overload \(1 bit - 1.005 DPT_Alarm\)](#)

Parameter	Description	Value
Emission	The Overload communication object is sent: On switching manual mode on or off. Periodically after a configurable time. On switching manual mode on or off and periodically after a configurable time.	On status change* Periodically On status change and periodically

Note: This parameter is only visible if the **Object Overload** parameter has the following value: **Active**.

Parameter	Description	Value
Periodical emission delay	This parameter determines the time between the individual transmissions of the Overload object.	00h00m00s to 23h59m59s (00h15m00s*)

Note: The smallest executable time is 1 second.

Note: This parameter is only visible if the **Emission** parameter has the following value: **Periodically** or **On status change and periodically**.

3.7.9.3 Short circuit

Parameter	Description	Value
Objet shortcircuit	This parameter is used to authorize the Short circuit object. This object is used for notification of a short circuit on the output concerned, via the KNX bus.	Not active* Active

* Default value

Communication objects:

- [28 - Output 1 - Short circuit](#) (1 bit - 1.005 DPT_Alarm)
- [59 - Output 2 - Short circuit](#) (1 bit - 1.005 DPT_Alarm)
- [90 - Output 3 - Short circuit](#) (1 bit - 1.005 DPT_Alarm)
- [121 - Output 4 - Short circuit](#) (1 bit - 1.005 DPT_Alarm)

Parameter	Description	Value
Emission	The Short circuit communication object is sent: On switching manual mode on or off. Periodically after a configurable time. On switching manual mode on or off and periodically after a configurable time.	On status change* Periodically On status change and periodically

*Note: This parameter is only visible if the **Short circuit** parameter has the following value: **Active**.*

Parameter	Description	Value
Periodical emission delay	This parameter determines the time between the individual transmissions of the Short circuit object.	00h00m00s to 23h59m59s (00h15m00s*)

Note: The smallest executable time is 1 second.

*Note: This parameter is only visible if the **Emission** parameter has the following value: **Periodically** or **On status change and periodically**.*

3.7.9.4 Over voltage

Parameter	Description	Value
Object over voltage	This parameter is used to authorize the Over voltage object. This object is used for notification of a short circuit on the output concerned, via the KNX bus.	Not active* Active

Communication objects:

- [29 - Output 1 - Over voltage](#) (1 bit - 1.005 DPT_Alarm)
- [60 - Output 2 - Over voltage](#) (1 bit - 1.005 DPT_Alarm)
- [91 - Output 3 - Over voltage](#) (1 bit - 1.005 DPT_Alarm)
- [122 - Output 4 - Over voltage](#) (1 bit - 1.005 DPT_Alarm)

Parameter	Description	Value
Emission	The Over voltage communication object is sent: On switching manual mode on or off. Periodically after a configurable time. On switching manual mode on or off and periodically after a configurable time.	On status change* Periodically On status change and periodically

*Note: This parameter is only visible if the **Object Dimming mode** parameter has the following value: **Active**.*

* Default value

Parameter	Description	Value
Periodical emission delay	This parameter determines the time between the individual transmissions of the Short circuit object.	00h00m00s to 23h59m59s (00h15m00s*)

Note: The smallest executable time is 1 second.

Note: This parameter is only visible if the **Emission** parameter has the following value: **Periodically** or **On status change and periodically**.

3.7.9.5 Over temperature

Parameter	Description	Value
Object over temperature	This parameter is used to authorize the Over temperature object. This object is used for notification of an over temperature on the output concerned, via the KNX bus. An over temperature arises when a load is connected to the output that results in a temperature increase in the output current circuit.	Not active* Active

- Communication objects:
- [30 - Output 1 - Over temperature \(1 bit - 1.005 DPT_Alarm\)](#)
 - [61 - Output 2 - Over temperature \(1 bit - 1.005 DPT_Alarm\)](#)
 - [92 - Output 3 - Over temperature \(1 bit - 1.005 DPT_Alarm\)](#)
 - [123 - Output 4 - Over temperature \(1 bit - 1.005 DPT_Alarm\)](#)

Note: This parameter is only visible if the **Object over temperature** parameter has the following value: **Active**.

Parameter	Description	Value
Emission	The Over temperature communication object is sent: On switching manual mode on or off. Periodically after a configurable time. On switching manual mode on or off and periodically after a configurable time.	On status change* Periodically On status change and periodically

Parameter	Description	Value
Periodical emission delay	This parameter determines the time between the individual transmissions of the Over temperature object.	00h00m00s to 23h59m59s (00h15m00s*)

Note: The smallest executable time is 1 second.

Note: This parameter is only visible if the **Emission** parameter has the following value: **Periodically** or **On status change and periodically**.

3.7.9.6 Load default

Parameter	Description	Value
Object load default	This parameter is used to authorize the object load default . This object is used for notification of a load default on the output concerned, via the KNX bus. Load default means that the output has no load or a defective load.	Not active* Active

* Default value

Communication objects:

- 31 - Output 1 - Load default** (1 bit - 1.005 DPT_Alarm)
- 62 - Output 2 - Load default** (1 bit - 1.005 DPT_Alarm)
- 93 - Output 3 - Load default** (1 bit - 1.005 DPT_Alarm)
- 124 - Output 4 - Load default** (1 bit - 1.005 DPT_Alarm)

Parameter	Description	Value
Emission	The Load default communication object is sent: On switching manual mode on or off. Periodically after a configurable time. On switching manual mode on or off and periodically after a configurable time.	On status change* Periodically On status change and periodically

*Note: This parameter is only visible if the **Object load default** parameter has the following value: **Active**.*



















Parameter	Description	Value
Periodical emission delay	This parameter determines the time between the individual transmissions of the Load default object.	00h00m00s to 23h59m59s (00h15m00s*)

Note: The smallest executable time is 1 second.

*Note: This parameter is only visible if the **Emission** parameter has the following value: **Periodically** or **On status change and periodically**.*

4. Communication objects

4.1 Communication objects General

	Number	Name	Function of the object	Length	C	R	W	T
	125	Outputs 1-4	Deactivation of manual mode	1 bit	C	R	W	-
	126	Outputs 1-4	Status indication manual mode	1 bit	C	R	-	T
	127	Logic block 1	Authorization	1 bit	C	R	W	-
	128	Logic block 1	Input 1	1 bit	C	R	W	-
	129	Logic block 1	Input 2	1 bit	C	R	W	-
	130	Logic block 1	Input 3	1 bit	C	R	W	-
	131	Logic block 1	Input 4	1 bit	C	R	W	-
	132	Logic block 1	Logic result	1 bit	C	R	-	T
	133	Logic block 2	Authorization	1 bit	C	R	W	-
	134	Logic block 2	Input 1	1 bit	C	R	W	-
	135	Logic block 2	Input 2	1 bit	C	R	W	-
	136	Logic block 2	Input 3	1 bit	C	R	W	-
	137	Logic block 2	Input 4	1 bit	C	R	W	-
	138	Logic block 2	Logic result	1 bit	C	R	-	T
	139	Outputs 1-4	Restore ETS-params settings	1 bit	C	R	W	-
	140	Outputs 1-4	Device LED switch off	1 bit	C	R	W	-
	141	Outputs 1-4	Diagnosis	6 byte	C	R	-	T
	142	Outputs 1-4	Deactivation of output combination test	1 bit	C	R	W	-
	143	Outputs 1-4	Status indication of output combination test	1 bit	C	R	-	T

4.1.1 Manual mode

No.	Name	Function of the object	Data type	Flags
125	Outputs 1-4	Deactivation of manual mode	1 bit - 1.001 DPT_Switch	C, R, W
<p>This object is activated if the Manual mode parameter and the Deactivation of manual mode object are active. This object is used to control the manual mode via the KNX bus. Object value: Depends on the Polarity parameter.</p> <p>0 = Manual mode locked-up, 1 = Manual mode authorized:</p> <ul style="list-style-type: none"> - If the object receives the value 1, manual mode is activated. - If the object receives the value 0, manual mode is deactivated. <p>0 = Manual mode authorized, 1 = Manual mode locked-up:</p> <ul style="list-style-type: none"> - If the object receives the value 1, manual mode is deactivated. - If the object receives the value 0, manual mode is activated. <p>For further information, see: Manual mode.</p>				

No.	Name	Function of the object	Data type	Flags
126	Outputs 1-4	Status indication manual mode	1 bit - 1.011 DPT_State	C, R, T
<p>This object is activated if the Manual mode parameter and the Object status indication manual mode are active. This object is used to send the manual mode status of the device via the KNX bus. Object value: Depends on the Polarity parameter.</p> <p>0 = Manual mode activated, 1 = Manual mode deactivated:</p> <ul style="list-style-type: none"> - If manual mode is deactivated, a telegram is sent with logic value 1. - If manual mode is activated, a telegram is sent with logic value 0. <p>0 = Manual mode deactivated, 1 = Manual mode activated:</p> <ul style="list-style-type: none"> - If manual mode is activated, a telegram is sent with logic value 1. - If manual mode is deactivated, a telegram is sent with logic value 0. <p>This object is sent periodically and/or on status change. For further information, see: Manual mode.</p>				

4.1.2 Logic block

No.	Name	Function of the object	Data type	Flags
127	Logic block 1	Authorization	1 bit - 1.003 DPT_Enable	C, R, W
<p>This object is activated if the Logic block 1 parameter and the Lock-up logic block object are active. This object makes it possible to activate or deactivate the logic blocks of the device via the KNX bus. Object value: Depends on the Polarity parameter.</p> <p>0 = Locked-up, 1 = Authorized:</p> <ul style="list-style-type: none"> - If the object receives the value 0, logic block 1 is deactivated. - If the object receives the value 1, logic block 1 is activated. <p>0 = Authorized, 1 = Locked-up:</p> <ul style="list-style-type: none"> - If the object receives the value 0, logic block 1 is activated. - If the object receives the value 1, logic block 1 is deactivated. <p>The value of this object can be initialized at start-up of the device.</p> <p>For further information, see: Logic block.</p>				

No.	Name	Function of the object	Data type	Flags
128	Logic block 1	Input 1	1 bit - 1.002 DPT_Bool	C, R, W
129	Logic block 1	Input 2	1 bit - 1.002 DPT_Bool	C, R, W
130	Logic block 1	Input 3	1 bit - 1.002 DPT_Bool	C, R, W
131	Logic block 1	Input 4	1 bit - 1.002 DPT_Bool	C, R, W
<p>These objects are activated in accordance with the value of the Number of logic inputs parameter. There may be up to a maximum of 4 of these objects. These objects are used to produce the status of a logic input for processing of the logic operation. The value of these objects can be initialized at start-up of the device.</p> <p>For further information, see: Logic block.</p>				

No.	Name	Function of the object	Data type	Flags
132	Logic block 1	Logic result	1 bit - 1.002 DPT_Bool	C, R, T
<p>This object is activated when the Logic block 1 parameter is active. This object enables output of the results of the logic operation via the bus. The value of the object is the result of a logic AND or OR operation, according to the status of the logic inputs. There may be up to a maximum of 4 of these objects. This result can also be directly assigned to the status of the output contact.</p> <p>For further information, see: Logic block.</p>				

No.	Name	Function of the object	Data type	Flags
133	Logic block 2	Authorization	1 bit - 1.003 DPT_Enable	C, R, W
See object No. 127				

No.	Name	Function of the object	Data type	Flags
134	Logic block 2	Input 1	1 bit - 1.002 DPT_Bool	C, R, W
135	Logic block 2	Input 2	1 bit - 1.002 DPT_Bool	C, R, W
136	Logic block 2	Input 3	1 bit - 1.002 DPT_Bool	C, R, W
137	Logic block 2	Input 4	1 bit - 1.002 DPT_Bool	C, R, W
See object No. 128				

No.	Name	Function of the object	Data type	Flags
138	Logic block 2	Logic result	1 bit - 1.002 DPT_Bool	C, R, T
See object No. 132				

4.1.3 Behaviour of the device

No.	Name	Function of the object	Data type	Flags
139	Outputs 1-4	Restore ETS-params settings	1 bit - 1.015 DPT_Reset	C, R, W
<p>This object is activated if the Activ. of restore ETS-parameters object (scenes, timer, setpoints) parameter is active.</p> <p>This object enables the current parameter value to be replaced at any time with the ETS parameter value.</p> <p>If the object receives value 1, then the output status values for the scenes, the timer duration specifications and all the counter setpoints are reset to the values sent by the last download.</p> <p>For further information, see: Restore ETS-Parameters.</p>				

No.	Name	Function of the object	Data type	Flags
140	Outputs 1-4	Device LED switch off	1 bit - 1.001 DPT_Switch	C, R, W
<p>This object is activated if the Device LEDS lock-up object parameter is active.</p> <p>This function is used to reduce the overall power consumption of the device. It allows the LEDs on the front of the device to be switched off.</p> <p>Object value: Depends on the Polarity parameter.</p> <p>0 = Status indication, 1 = Always OFF:</p> <ul style="list-style-type: none"> - If the object receives value 0, the LED display is activated. - If the object receives value 1, the LED display is deactivated. <p>0 = Always OFF, 1 = Status indication:</p> <ul style="list-style-type: none"> - If the object receives value 0, the LED display is deactivated. - If the object receives value 1, the LED display is activated. <p>For further information, see: LED display.</p>				

4.1.4 Diagnosis

No.	Name	Function of the object	Data type	Flags														
141	Outputs 1-4	Diagnosis	6 byte - Specific	C, R, T														
<p>This object is activated when the Device diagnosis object parameter is active. The object enables reporting of current faults according to the device and the application used. It also allows sending of the position of the switch on the front of the device and the number of the output that is affected by the fault(s).</p> <table border="1" data-bbox="140 539 1444 638"> <thead> <tr> <th>Byte number</th> <th>6 (MSB)</th> <th>5</th> <th>4</th> <th>3</th> <th>2</th> <th>1(LSB)</th> </tr> </thead> <tbody> <tr> <td>Use</td> <td>Switch position</td> <td>Application type</td> <td>Output number</td> <td colspan="3">Error codes</td> </tr> </tbody> </table> <p>This object is sent periodically and/or on status change. For further information, see: Diagnosis.</p>					Byte number	6 (MSB)	5	4	3	2	1(LSB)	Use	Switch position	Application type	Output number	Error codes		
Byte number	6 (MSB)	5	4	3	2	1(LSB)												
Use	Switch position	Application type	Output number	Error codes														

4.1.5 Check output combination when switching into manual mode

No.	Name	Function of the object	Data type	Flags
142	Outputs 1-4	Deactivation of output combination test	1 bit - 1.001 DPT_Switch	C, R, W
<p>This object is activated when the Output combination test on switching to manual mode and Deactivation of the output combination test object parameters are active. This object controls the activation by the KNX bus of the output combination test on switching to manual mode.</p> <p>Object value: Depends on the Polarity parameter. 0=Combination test Locked up, 1=Combination test Authorized:</p> <ul style="list-style-type: none"> - If the object receives the value 0, the output combination test is locked up. - If the object receives the value 1, the output combination test is authorized. <p>0=Combination test Authorized, 1=Combination test Locked up:</p> <ul style="list-style-type: none"> - If the object receives the value 1, the output combination test is locked up. - If the object receives the value 0, the output combination test is authorized. <p>For further information, see: Deactivation of output combination test.</p>				

No.	Name	Function of the object	Data type	Flags
143	Outputs 1-4	Status indication of output combination test	1 bit - 1.011 DPT_State	C, R, T
<p>This object is activated when the Output combination test on switching to manual mode and Deactivation of the output combination test object parameters are active. This object sends the status of the output combination test on the KNX bus.</p> <p>Object value: Depends on the Polarity parameter. 0=Combination test Deactiv., 1=Combination test Activ.:</p> <ul style="list-style-type: none"> - If the output combination test is deactivated, a telegram is sent with logic value 0. - If the output combination test is activated, a telegram with logic value 1 is sent. <p>0=Combination test Activ., 1=Combination test Deactiv.:</p> <ul style="list-style-type: none"> - If the output combination test is deactivated, a telegram is sent with logic value 1. - If the output combination test is activated, a telegram with logic value 0 is sent. <p>This object is sent periodically and/or on status change.</p> <p>For further information, see: Status indication of output combination test.</p>				

4.2 Output communication objects

	Number	Name	Function of the object	Length	C	R	W	T
	1	Output 1	ON/OFF	1 bit	C	R	W	-
	2	Output 1	Dimming	1 bit	C	R	W	-
	3	Output 1	Brightness value	1 byte	C	R	W	-
	4	Output 1	Load memorisation	1 bit	C	R	W	-
	5	Output 1	Default memorisation	1 bit	C	R	-	T
	6	Output 1	Timer/toggle switch changeover	1 bit	C	R	W	-
	7	Output 1	Time limited toggle switch	1 bit	C	R	W	-
	8	Output 1	Status indication ON/OFF	1 bit	C	R	-	T
	9	Output 1	Status ind. brightness value	1 byte	C	R	-	T
	10	Output 1	Timer	1 bit	C	R	W	-
	11	Output 1	Timer duration	3 byte	C	R	W	-
	12	Output 1	Scene	1 byte	C	R	W	-
	13	Output 1	Preset 1	1 bit	C	R	W	-
	14	Output 1	Preset 2	1 bit	C	R	W	-
	15	Output 1	Preset 1 authorization	1 bit	C	R	W	-
	16	Output 1	Preset 2 authorization	1 bit	C	R	W	-
	17	Output 1	Lock-up 1	1 bit	C	R	W	-
	18	Output 1	Lock-up 2	1 bit	C	R	W	-
	19	Output 1	Status indication lock-up	1 bit	C	R	-	T
	20	Output 1	Priority	2 bit	C	R	W	-
	21	Output 1	Status indication priority	1 bit	C	R	-	T
	22	Output 1	Hours counter value	2 byte	C	R	-	T
	23	Output 1	Reset hours counter value	1 bit	C	R	W	-
	24	Output 1	Hours counter setpoint reached	1 bit	C	R	-	T
	25	Output 1	Hours counter setpoint	2 byte	C	R	W	-
	26	Output 1	Dimming mode	1 bit	C	R	-	T
	27	Output 1	Overload	1 bit	C	R	-	T
	28	Output 1	Short circuit	1 bit	C	R	-	T
	29	Output 1	Over voltage	1 bit	C	R	-	T
	30	Output 1	Over temperature	1 bit	C	R	-	T
	31	Output 1	Load default	1 bit	C	R	-	T

	Number	Name	Function of the object	Length	C	R	W	T
	32	Output 2	ON/OFF	1 bit	C	R	W	-
	33	Output 2	Dimming	1 bit	C	R	W	-
	34	Output 2	Brightness value	1 byte	C	R	W	-
	35	Output 2	Load memorisation	1 bit	C	R	W	-
	36	Output 2	Default memorisation	1 bit	C	R	-	T
	37	Output 2	Timer/toggle switch changeover	1 bit	C	R	W	-
	38	Output 2	Time limited toggle switch	1 bit	C	R	W	-
	39	Output 2	Status indication ON/OFF	1 bit	C	R	-	T
	40	Output 2	Status ind. brightness value	1 byte	C	R	-	T
	41	Output 2	Timer	1 bit	C	R	W	-
	42	Output 2	Timer duration	3 byte	C	R	W	-
	43	Output 2	Scene	1 byte	C	R	W	-
	44	Output 2	Preset 1	1 bit	C	R	W	-
	45	Output 2	Preset 2	1 bit	C	R	W	-
	46	Output 2	Preset 1 authorization	1 bit	C	R	W	-
	47	Output 2	Preset 2 authorization	1 bit	C	R	W	-
	48	Output 2	Lock-up 1	1 bit	C	R	W	-
	49	Output 2	Lock-up 2	1 bit	C	R	W	-
	50	Output 2	Status indication lock-up	1 bit	C	R	-	T
	51	Output 2	Priority	2 bit	C	R	W	-
	52	Output 2	Status indication priority	1 bit	C	R	-	T
	53	Output 2	Hours counter value	2 byte	C	R	-	T
	54	Output 2	Reset hours counter value	1 bit	C	R	W	-
	55	Output 2	Hours counter setpoint reached	1 bit	C	R	-	T
	56	Output 2	Hours counter setpoint	2 byte	C	R	W	-
	57	Output 2	Dimming mode	1 bit	C	R	-	T
	58	Output 2	Overload	1 bit	C	R	-	T
	59	Output 2	Short circuit	1 bit	C	R	-	T
	60	Output 2	Over voltage	1 bit	C	R	-	T
	61	Output 2	Over temperature	1 bit	C	R	-	T
	62	Output 2	Load default	1 bit	C	R	-	T

	Number	Name	Function of the object	Length	C	R	W	T
	63	Output 3	ON/OFF	1 bit	C	R	W	-
	64	Output 3	Dimming	1 bit	C	R	W	-
	65	Output 3	Brightness value	1 byte	C	R	W	-
	66	Output 3	Load memorisation	1 bit	C	R	W	-
	67	Output 3	Default memorisation	1 bit	C	R	-	T
	68	Output 3	Timer/toggle switch changeover	1 bit	C	R	W	-
	69	Output 3	Time limited toggle switch	1 bit	C	R	W	-
	70	Output 3	Status indication ON/OFF	1 bit	C	R	-	T
	71	Output 3	Status ind. brightness value	1 byte	C	R	-	T
	72	Output 3	Timer	1 bit	C	R	W	-
	73	Output 3	Timer duration	3 byte	C	R	W	-
	74	Output 3	Scene	1 byte	C	R	W	-
	75	Output 3	Preset 1	1 bit	C	R	W	-
	76	Output 3	Preset 2	1 bit	C	R	W	-
	77	Output 3	Preset 1 authorization	1 bit	C	R	W	-
	78	Output 3	Preset 2 authorization	1 bit	C	R	W	-
	79	Output 3	Lock-up 1	1 bit	C	R	W	-
	80	Output 3	Lock-up 2	1 bit	C	R	W	-
	81	Output 3	Status indication lock-up	1 bit	C	R	-	T
	82	Output 3	Priority	2 bit	C	R	W	-
	83	Output 3	Status indication priority	1 bit	C	R	-	T
	84	Output 3	Hours counter value	2 byte	C	R	-	T
	85	Output 3	Reset hours counter value	1 bit	C	R	W	-
	86	Output 3	Hours counter setpoint reached	1 bit	C	R	-	T
	87	Output 3	Hours counter setpoint	2 byte	C	R	W	-
	88	Output 3	Dimming mode	1 bit	C	R	-	T
	89	Output 3	Overload	1 bit	C	R	-	T
	90	Output 3	Short circuit	1 bit	C	R	-	T
	91	Output 3	Over voltage	1 bit	C	R	-	T
	92	Output 3	Over temperature	1 bit	C	R	-	T
	93	Output 3	Load default	1 bit	C	R	-	T

	Number	Name	Function of the object	Length	C	R	W	T
	94	Output 4	ON/OFF	1 bit	C	R	W	-
	95	Output 4	Dimming	1 bit	C	R	W	-
	96	Output 4	Brightness value	1 byte	C	R	W	-
	97	Output 4	Load memorisation	1 bit	C	R	W	-
	98	Output 4	Default memorisation	1 bit	C	R	-	T
	99	Output 4	Timer/toggle switch changeover	1 bit	C	R	W	-
	100	Output 4	Time limited toggle switch	1 bit	C	R	W	-
	101	Output 4	Status indication ON/OFF	1 bit	C	R	-	T
	102	Output 4	Status ind. brightness value	1 byte	C	R	-	T
	103	Output 4	Timer	1 bit	C	R	W	-
	104	Output 4	Timer duration	3 byte	C	R	W	-
	105	Output 4	Scene	1 byte	C	R	W	-
	106	Output 4	Preset 1	1 bit	C	R	W	-
	107	Output 4	Preset 2	1 bit	C	R	W	-
	108	Output 4	Preset 1 authorization	1 bit	C	R	W	-
	109	Output 4	Preset 2 authorization	1 bit	C	R	W	-
	110	Output 4	Lock-up 1	1 bit	C	R	W	-
	111	Output 4	Lock-up 2	1 bit	C	R	W	-
	112	Output 4	Status indication lock-up	1 bit	C	R	-	T
	113	Output 4	Priority	2 bit	C	R	W	-
	114	Output 4	Status indication priority	1 bit	C	R	-	T
	115	Output 4	Hours counter value	2 byte	C	R	-	T
	116	Output 4	Reset hours counter value	1 bit	C	R	W	-
	117	Output 4	Hours counter setpoint reached	1 bit	C	R	-	T
	118	Output 4	Hours counter setpoint	2 byte	C	R	W	-
	119	Output 4	Dimming mode	1 bit	C	R	-	T
	120	Output 4	Overload	1 bit	C	R	-	T
	121	Output 4	Short circuit	1 bit	C	R	-	T
	122	Output 4	Over voltage	1 bit	C	R	-	T
	123	Output 4	Over temperature	1 bit	C	R	-	T
	124	Output 4	Load default	1 bit	C	R	-	T

4.2.1 ON/OFF

No.	Name	Function of the object	Data type	Flags
1, 32, 63, 94	Output x	ON/OFF	1 bit - 1.001 DPT_Switch	C, R, W

These objects are always activated. They enable switching of the output contact in accordance with the value that is sent via the KNX bus.

Object value: Object value: depends on the **Output contact** parameter.

Normally open:

- On input of an OFF command, the output relay contact opens.
- On input of an ON command, the output relay contact closes.

Normally closed:

- On input of an OFF command, the output relay contact closes.
- On input of an ON command, the output relay contact opens.

For further information, see: [Definition](#).

4.2.2 Dimming

No.	Name	Function of the object	Data type	Flags
2, 33, 64, 95	Output x	Dimming	4 bit - 3.007 DPT_DPT_Control_Dimming	C, R, W

These objects are always activated. They enable relative dimming of the output in accordance with the value that is sent on the KNX bus.

The output is dimmed in accordance with the 4-bit format value that arrives.

Object value:

b3	b2	b1	b0
C	Steps		

Data fields	Description	Code
C	Increase or reduction in brightness	0: Decrease 1: Increase
Steps	Brightness between 0% and 100% divided into steps	0: Stop 1: 100% 2: 50% 3: 25% 4: 12% 5: 6% 6: 3% 7: 1%

For further information, see: [Definition](#).

No.	Name	Function of the object	Data type	Flags
3, 34, 65, 96	Output x	Brightness value	1 byte - 5.001 DPT_Scaling	C, R, W
<p>These objects are always activated. They enable absolute dimming of the output in accordance with the value that is sent on the KNX bus.</p> <p>The output is dimmed according to the value that arrives in 1-byte format and corresponds in % to the brightness value to be attained.</p> <p>Object value: 0 to 255: 0 = 0%, 255 = 100%</p> <p>Resolution: Approx. 0.4%</p> <p>For further information, see: Definition.</p>				

4.2.3 Load memorisation

No.	Name	Function of the object	Data type	Flags
4, 35, 66, 97	Output x	Load memorisation	1 bit - 1.003 DPT_Enable	C, R, W
<p>These objects are always activated. They are used to start the memorisation process in accordance with the value that is sent on the KNX bus.</p> <p>This process lasts around 30 seconds and results in varying brightness.</p> <p>After the memorisation, the load is activated on the highest step and blinks once, to report that the learning is completed.</p> <p>If the object receives the value 1, the Load memorisation is started.</p> <p>For further information, see: Definition.</p>				

No.	Name	Function of the object	Data type	Flags
5, 36, 67, 98	Output x	Default memorisation	1 bit - 1.005 DPT_Alarm	C, R, T
<p>These objects are always activated. They are used for notification of a default memorisation.</p> <p>If the load is not recognised at the end of the learning process, the device automatically selects the Factory setting for the dimming mode.</p> <p>If learning of the load has failed, a telegram with logic value 1 is sent to the object.</p> <p>For further information, see: Definition.</p>				

4.2.4 ON/OFF timings function

No.	Name	Function of the object	Data type	Flags
6, 37, 68, 99	Output x	Timer/toggle switch changeover	1 bit - 1.001 DPT_Switch	C, R, W
<p>This object is activated if the Timer/toggle switch changeover for ON/OFF object parameter is active.</p> <p>This object is used to switch between a toggle switch and timer switch operation on the same pushbutton.</p> <ul style="list-style-type: none"> - If the Timer/toggle switch changeover object receives the value 1, the Toggle-switch mode function is activated. The ON/OFF switching of the output is performed as usual via the ON/OFF object. - If the Timer/toggle switch changeover object receives the value 0, the Timer mode function is activated. <ul style="list-style-type: none"> - If the ON/OFF object receives the value 1, the output is switched ON. After expiry of a configurable time, the output is automatically switched OFF. - If the ON/OFF object receives the value 0, the output is switched OFF. <p><i>Example: Switching function daytime and Time-limited OFF function at night.</i></p> <p><i>During the day, the button is used as a switch. In the evenings, the button is used as a time-limited OFF switch, so that the light will turn off automatically.</i></p> <p>For further information, see: ON/OFF timings function.</p>				

No.	Name	Function of the object	Data type	Flags
7, 38, 69, 100	Output x	Time limited toggle switch	1 bit - 1.001 DPT_Switch	C, R, W
<p>This object is activated when the Additional time limited toggle switch function parameter is active.</p> <p>This object combines a timer function with a tripping Delay function.</p> <ul style="list-style-type: none"> - If the object receives the value 1, the output switches to ON for a configurable time period. After that period expires, the output switches to OFF. - If the object receives the value 0, the output switches to OFF. <p><i>Note: The time-limited OFF function is generally used for lighting in cellars, attics and sheds.</i></p> <p>For further information, see: ON/OFF timings function.</p>				

4.2.5 Status indication

No.	Name	Function of the object	Data type	Flags
8, 39, 70, 101	Output x	Status indication ON/OFF	1 bit - 1.001 DPT_Switch	C, R, T
<p>This object is activated when the Status indication ON/OFF parameter is active.</p> <p>This object allows the status of the output contact to be sent from the device over the KNX bus.</p> <p>Object value: Depends on the Polarity parameter.</p> <p>0 = ON, 1 = OFF</p> <ul style="list-style-type: none"> - If the output relay is open, a telegram with logic value 1 is sent on the KNX bus. - If the output relay is closed, a telegram with logic value 0 is sent on the KNX bus. <p>0 = OFF, 1 = ON</p> <ul style="list-style-type: none"> - If the output relay is open, a telegram with logic value 0 is sent on the KNX bus. - If the output relay is closed, a telegram with logic value 1 is sent on the KNX bus. <p>This object is sent periodically and/or on status change.</p> <p>For further information, see: Status indication.</p>				

No.	Name	Function of the object	Data type	Flags
9, 40, 71, 102	Output x	Status ind. brightness value	1 byte - 5.001 DPT_Scaling	C, R, T
<p>This object is activated when the Status ind. brightness value parameter is active.</p> <p>This object allows the status of the brightness value of the Output to be sent over the KNX bus.</p> <p>Object value: 0 to 255: 0 = 0%, 255 = 100%</p> <p>For further information, see: Status indication.</p>				

4.2.6 Timer

No.	Name	Function of the object	Data type	Flags
10, 41, 72, 103	Output x	Timer	1 bit - 1.001 DPT_Switch	C, R, W

This object is activated when the **Timer** parameter is active.
 This object is used to activate the Timer function of the device via the KNX bus.
 Object value:

- If a rising edge (0 to 1) arrives at this object, the output switches for a configurable period.
- If a falling edge (1 to 0) arrives at this object, the output remains in its current state.

Note: Depending on the configuration, the timer switching can be interrupted on the timer by a long press of the control button.
Note: Depending on the configuration, the timer duration may be reset by input of a start command during timer operation.

For further information, see: [Timer](#).

No.	Name	Function of the object	Data type	Flags
11, 42, 73, 104	Output x	Timer duration	3 byte - 10.001 DPT_TimeOfDay	C, R, W

This object is activated if the **Timer duration modifiable through object** object parameter is active.
 This object can be used to configure the timer duration. The timer duration can thus be configured in accordance with a time of day.

Byte 3 (MSB)					Byte 2						Byte 1 (LSB)												
			Hours				Minutes						Seconds										
0	0	0	H	H	H	H	H	0	0	M	M	M	M	M	M	0	0	S	S	S	S	S	S

Fields	Code	Value	Units
Hours	Binary	0 to 23 (5 bit)	Hours
Minutes	Binary	0 to 59 (6 bit)	Minutes
Seconds	Binary	0 to 59 (6 bit)	Seconds

For further information, see: [Timer](#).

4.2.7 Scene

No.	Name	Function of the object	Data type	Flags
12, 43, 74, 105	Output x	Scene	1 byte - 17.001 DPT_SceneNumber	C, R, W

This object is activated when the **Scene** parameter is active.

This object is used to recall or save a scene.

Details on the format of the object are given below.

7	6	5	4	3	2	1	0
Learning	Not used	Scene number					

Bit 7: 0: The scene is called / 1: The scene is saved.

Bit 6: Not used.

Bit 5 to Bit 0: Scene numbers from 0 (Scene 1) to 63 (Scene 64).

For further information, see: [Scene](#).

4.2.8 Preset

No.	Name	Function of the object	Data type	Flags
13, 44, 75, 106	Output x	Preset 1	1 bit - 1.022 DPT_Scene_AB	C, R, W

This object is activated if the **Preset** has value **Active with preset 1-level object** or **Active with preset 2-level objects**.

With this object, several outputs can be set to a configurable predefined status.

Object value:

- If the object receives value 0, the values of the parameters for Preset 1 = 0 are used.
- If the object receives value 1, the values of the parameters for Preset 1 = 1 are used.

For further information, see: [Preset](#).

No.	Name	Function of the object	Data type	Flags
14, 45, 76, 107	Output x	Preset 2	1 bit - 1.022 DPT_Scene_AB	C, R, W

This object is activated if the **Preset** parameter has value **Active with preset 2-level objects**.

See object No. 12

No.	Name	Function of the object	Data type	Flags
15, 46, 77, 108	Output x	Preset 1 authorization	1 bit - 1.003 DPT_Enable	C, R, W
<p>This object is activated if the Preset authorization objects parameter is active. This object allows the authorization or lock-up of the Preset 1 function via a KNX telegram. Object value: This is dependent on the Polarity of autorisation object Preset 1 parameter. 0 = Locked-up, 1 = Authorized:</p> <ul style="list-style-type: none"> - If the object receives the value 0, Preset 1 is deactivated. - If the object receives the value 1, Preset 1 is activated. <p>0 = Authorized, 1 = Locked-up:</p> <ul style="list-style-type: none"> - If the object receives the value 0, Preset 1 is activated. - If the object receives the value 1, Preset 1 is deactivated. <p>For further information, see: Preset.</p>				

No.	Name	Function of the object	Data type	Flags
16, 47, 78, 109	Output x	Preset 2 authorization	1 bit - 1.003 DPT_Enable	C, R, W
See object No. 14				

4.2.9 Lock-up

No.	Name	Function of the object	Data type	Flags
17, 48, 79, 110	Output x	Lock-up 1	1 bit - 1.003 DPT_Enable	C, R, W
<p>This object is activated if the Lock-up has value Active with 1 lock-up object or Active with 2 lock-up objects. This object is used to control the activation of the lock-up via the KNX bus. Object value: This is dependent on the Polarity of lock-up object 1 parameter. 0 = Lock-up activated, 1 = Lock-up deactivated:</p> <ul style="list-style-type: none"> - If the object receives value 0, the Lock-up is activated. - If the object receives value 1, the Lock-up is deactivated. <p>0 = Lock-up deactivated, 1 = Lock-up activated:</p> <ul style="list-style-type: none"> - If the object receives value 0, the Lock-up is deactivated. - If the object receives value 1, the Lock-up is activated. <p>For further information, see: Lock-up.</p>				

No.	Name	Function of the object	Data type	Flags
18, 49, 80, 111	Output x	Lock-up 2	1 bit - 1.003 DPT_Enable	C, R, W
<p>This object is activated if the Lock-up parameter has value Active with 2 lock-up objects.</p> <p>See object No. 16.</p>				

No.	Name	Function of the object	Data type	Flags
19, 50, 81, 112	Output x	Status indication lock-up	1 bit - 1.011 DPT_State	C, R, T
<p>This object is activated when the Activation of lock-up status object parameter is active. This object allows the status of the lock-up to be sent from the device over the KNX bus. Object value: Depends on the Polarity parameter. 0 = Lock-up deactivated, 1 = Lock-up activated:</p> <ul style="list-style-type: none"> - If the lock-up is deactivated, a telegram with logic value 0 is sent on the KNX bus. - If the lock-up is activated, a telegram with logic value 1 is sent on the KNX bus. <p>0 = Lock-up activated, 1 = Lock-up deactivated:</p> <ul style="list-style-type: none"> - If the lock-up is activated, a telegram with logic value 0 is sent on the KNX bus. - If the lock-up is deactivated, a telegram with logic value 1 is sent on the KNX bus. <p>This object is sent periodically and/or on status change. For further information, see: Lock-up.</p>				

4.2.10 Priority

No.	Name	Function of the object	Data type	Flags																	
20, 51, 82, 113	Output x	Priority	2 bit - 2.002 DPT_Bool_Control	C, R, W																	
<p>This object is activated if the Priority parameter is active. The status of the output contact is determined directly by this object. Details on the format of the object are given below.</p> <table border="1" style="margin: 10px auto;"> <thead> <tr> <th colspan="2">Telegram received by the priority operation object</th> <th rowspan="2">Status of the outputs</th> </tr> <tr> <th>Bit 1</th> <th>Bit 2</th> </tr> </thead> <tbody> <tr> <td>0</td> <td>0</td> <td>End of the priority</td> </tr> <tr> <td>0</td> <td>1</td> <td>End of the priority</td> </tr> <tr> <td>1</td> <td>0</td> <td>Priority OFF</td> </tr> <tr> <td>1</td> <td>1</td> <td>Priority ON</td> </tr> </tbody> </table> <p>The first bit of this object (Bit 0) determines the status of the output contact, which should be priority controlled. The second bit activates or deactivates the Priority. For further information, see: Priority.</p>					Telegram received by the priority operation object		Status of the outputs	Bit 1	Bit 2	0	0	End of the priority	0	1	End of the priority	1	0	Priority OFF	1	1	Priority ON
Telegram received by the priority operation object		Status of the outputs																			
Bit 1	Bit 2																				
0	0	End of the priority																			
0	1	End of the priority																			
1	0	Priority OFF																			
1	1	Priority ON																			

No.	Name	Function of the object	Data type	Flags
21, 52, 83, 114	Output x	Status indication priority	1 bit - 1.011 DPT_State	C, R, T
<p>This object is activated if the Activation of priority status object parameter is active. This object allows the status of the Priority to be sent from the device on the KNX bus. Object value: Depends on the Polarity parameter.</p> <p>0 = Not forced, 1 = Forced:</p> <ul style="list-style-type: none"> - If Priority is deactivated, a telegram is sent with logic value 0. - If Priority is activated, a telegram is sent with logic value 1. <p>0 = Forced, 1 = Not forced:</p> <ul style="list-style-type: none"> - If Priority is activated, a telegram is sent with logic value 0. - If Priority is deactivated, a telegram is sent with logic value 1. <p>This object is sent periodically and/or on status change. For further information, see: Priority.</p>				

4.2.11 Hours counter

No.	Name	Function of the object	Data type	Flags
22, 53, 84, 115	Output x	Hours counter value (h)	2 byte - 7.007 DPT_Time(h)	C, R, T
<p>This object is activated when the Hours counter parameter is active. This object allows the value of the operating hours to be sent from the device on the KNX bus. The count value is saved during a power cut on the KNX bus. It is submitted after return of power to the bus or after an ETS download. Object value: 0 to 65535 hours.</p> <p>This object is sent periodically and/or on status change. For further information, see: Hours counter.</p>				

No.	Name	Function of the object	Data type	Flags
23, 54, 85, 116	Output x	Reset hours counter value	1 bit - 1.003 DPT_Enable	C, R, W
<p>This object is activated when the Hours counter parameter is active. This object enables the hours counter value to be reset. Object value:</p> <ul style="list-style-type: none"> - If the object receives the value 0, the counter is not reset. - If the object receives the value 1, the counter is reset. <p>For further information, see: Hours counter.</p>				

No.	Name	Function of the object	Data type	Flags
24, 55, 86, 117	Output x	Hours counter setpoint reached	1 bit - 1.011 DPT_State	C, R, T
<p>This object is activated when the Hours counter parameter is active. This object reports that the hours counter has reached its setpoint.</p> <ul style="list-style-type: none"> - Incrementing counter: Counter = Counter value setpoint. - Countdown counter: Counter = 0. <p>Object value: If the setpoint is reached, a telegram with logic value 1 is sent on the KNX bus. The count value is saved during a power cut on the KNX bus. It is submitted after return of power to the bus or after an ETS download.</p> <p>This object is sent periodically and/or on status change. For further information, see: Hours counter.</p>				

No.	Name	Function of the object	Data type	Flags
25, 56, 87, 118	Output x	Counter value setpoint (h)	2 byte - 7.007 DPT_Time(h)	C, R, W
<p>This object is activated if the Counter setpoint value modifiable through object object parameter is active. This object is used to initialize the counter setpoint of the hours counter via the KNX bus. Object value: 0 to 65535 hours.</p> <p>This object is sent periodically and/or on status change. For further information, see: Hours counter.</p>				

4.2.12 Notifications

No.	Name	Function of the object	Data type	Flags
27, 58, 89, 120	Output x	Overload	1 bit - 1.005 DPT_Alarm	C, R, T
<p>This object is activated when the Overload parameter is active. This object is used for notification of an overload on the output concerned, via the KNX bus. An overload arises, for example, when several lamps are connected to the output, exceeding its rated power. Object value: If an overload is detected on the output concerned, a telegram with logic value 1 is sent to the object.</p> <p>This object is sent periodically and/or on status change. For further information, see: Notifications.</p>				

No.	Name	Function of the object	Data type	Flags
28, 59, 90, 121	Output x	Short circuit	1 bit - 1.005 DPT_Alarm	C, R, T
<p>This object is activated when the Short circuit parameter is active. This object is used for notification of a short circuit on the output concerned, via the KNX bus. Object value: If a short circuit is detected on the output concerned, a telegram with logic value 1 is sent to the object.</p> <p>This object is sent periodically and/or on status change. For further information, see: Notifications.</p>				

No.	Name	Function of the object	Data type	Flags
29, 60, 91, 122	Output x	Over voltage	1 bit - 1.005 DPT_Alarm	C, R, T
<p>This object is activated when the Over voltage parameter is active. This object is used for notification of an over voltage on the output concerned, via the KNX bus. Object value: If an over voltage is detected on the output concerned, a telegram with logic value 1 is sent to the object.</p> <p>This object is sent periodically and/or on status change. For further information, see: Notifications.</p>				

No.	Name	Function of the object	Data type	Flags
30, 61, 92, 123	Output x	Over temperature	1 bit - 1.005 DPT_Alarm	C, R, T
<p>This object is activated when the Over temperature parameter is active. This object is used for notification of an over temperature on the output concerned, via the KNX bus. An over temperature arises when a load is connected to the output that results in a temperature increase in the output current circuit. Object value: If an overload is detected on the output concerned, a telegram with logic value 1 is sent to the object.</p> <p>This object is sent periodically and/or on status change. For further information, see: Notifications.</p>				

No.	Name	Function of the object	Data type	Flags
31, 62, 93, 124	Output x	Load default	1 bit - 1.005 DPT_Alarm	C, R, T
<p>This object is activated if the Load default parameter is active.</p> <p>This object is used for notification of a load default on the output concerned, via the KNX bus. Load default means that the output has no load or a defective load.</p> <p>Object value: If a load default is detected on the output concerned, a telegram with logic value 1 is sent to the object.</p> <p>This object is sent periodically and/or on status change.</p> <p>For further information, see: Notifications.</p>				

5. Appendix

5.1 Specifications

TYAS664AN

KNX Medium	TP1-256
Supply voltage KNX	21...32 V \equiv SELV
Current consumption KNX	typ. 2,4 mA
Supply voltage via network	230 V \sim +10/-15%; 50/60 Hz
	240 V \sim +/-6%; 50/60 Hz
Max. power dissipation	2,4W
Miniature circuit breake	10 A
Surge voltage	4 kV
Operating altitude	max. 2000 m
Degree of contamination	2
Operating temperature	-5° ... +45 °C
Dimension	8 TE, 8 x 17.5 mm

5.2 Table of logical operations

Input 4	Input 3	Input 2	Input 1	OR	AND
-	-	0	0	0	0
-	-	0	1	1	0
-	-	1	0	1	0
-	-	1	1	1	1
-	0	0	0	0	0
-	0	0	1	1	0
-	0	1	0	1	0
-	0	1	1	1	0
-	1	0	0	1	0
-	1	0	1	1	0
-	1	1	0	1	0
-	1	1	1	1	1
0	0	0	0	0	0
0	0	0	1	1	0
0	0	1	0	1	0
0	0	1	1	1	0
0	1	0	0	1	0
0	1	0	1	1	0
0	1	1	0	1	0
0	1	1	1	1	0
1	0	0	0	1	0
1	0	0	1	1	0
1	0	1	0	1	0
1	0	1	1	1	0
1	1	0	0	1	0
1	1	0	1	1	0
1	1	1	0	1	0
1	1	1	1	1	1

5.3 Characteristics

Device	TYAS664AN
Max. number of group addresses	254
Max. number of allocations	255
Objects	143

Hager Controls
BP10140
67703 Saverne Cedex, France
T +33 (0) 3 88 02 87 00
info@hager.com
hager.com