

EN

TJA670 domovea Basic

TJA470 domovea Expert

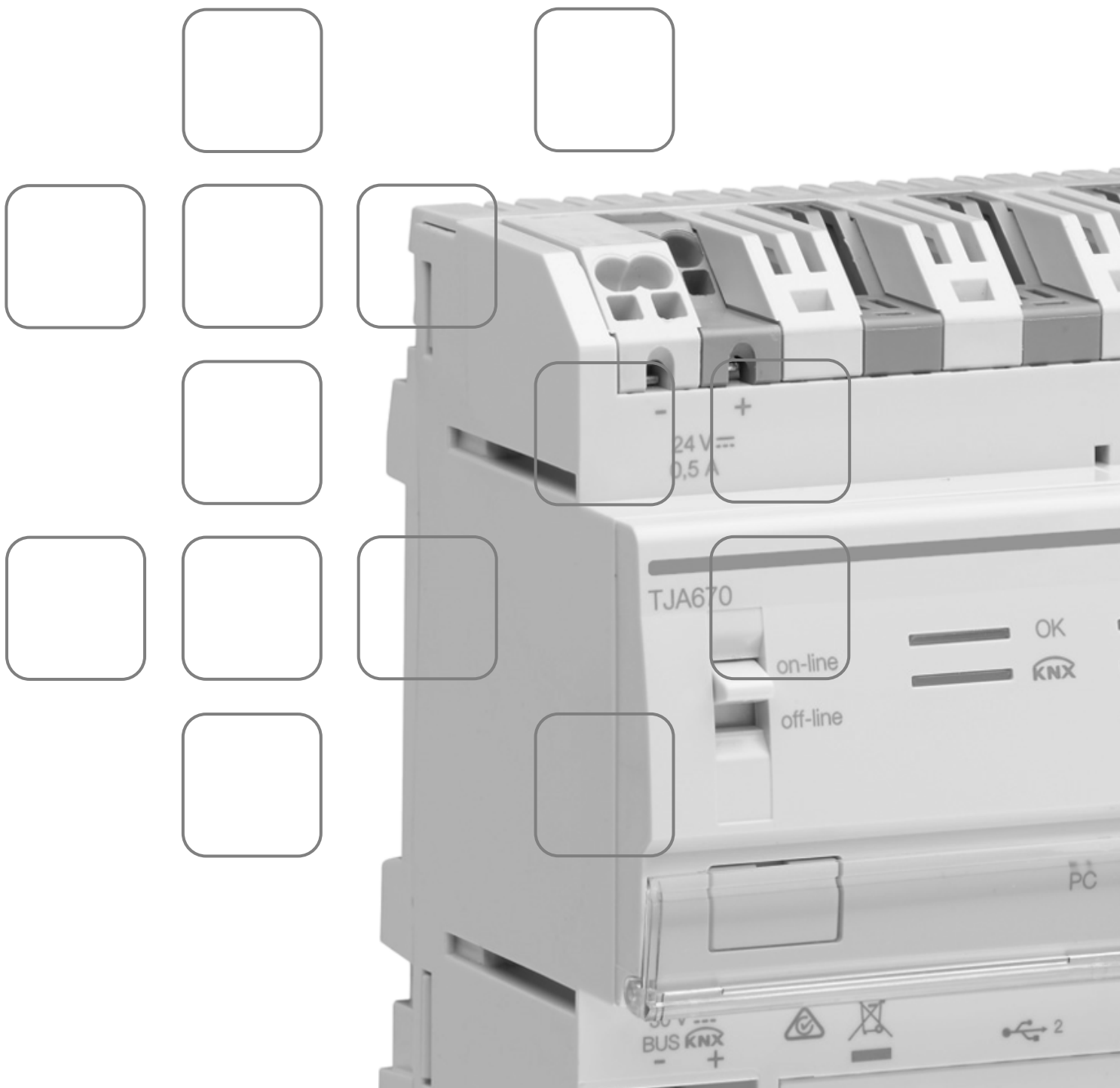

CONTENTS

1 INTRODUCTION	4
1.1 Purpose of the document.....	4
1.2 General information on the KNX installations	4
2 GENERAL DESCRIPTION.....	5
2.1 Introduction to the system.....	5
2.2 System overview	5
2.3 The domovea solution	6
2.4 Introduction to the domovea TJA670-TJA470 server.....	6
2.4.1 The configuration server.....	6
2.4.2 Software version update for the domovea server.....	7
2.4.3 Auto/Router functionality	8
2.4.4 Technical specifications.....	9
2.5 Software installation	10
2.5.1 Installing the Hager Pilot application.....	10
2.5.2 Launching the Hager Pilot application	10
2.5.3 Accessing the configurator without using hager Pilot.....	10
2.5.4 Logging onto the server.....	11
2.6 Using the system.....	11
2.6.1 Installing the domovea Client application	11
2.6.2 Launch the domovea application	11
2.6.3 Log in using the domovea application.....	11
2.6.4 What to do if you lose your password	12
2.7 Connexion KNX IP secure	14
2.8 Connection using the KNX / IP bridge	16
2.8.1 Connection with a local network.....	16
2.8.2 Connection with a remote network.....	17
3 FIRST USE.....	19
3.1 New project.....	19
3.2 From a backup file.....	19
3.3 Using relearning	19
4 MY PROJECT	20
5 RELATED FUNCTIONS IN THE MENUS	21
5.1 Account configuration	21
5.2 Settings.....	21
5.2.1 Configuration.....	21
5.2.2 Users	23
5.2.3 Data management	24
5.2.4 About	26
6 MY DOMOVEA INSTALLATION	27
6.1 Dashboard.....	27
6.2 Installation.....	28
6.2.1 Devices	28

6.2.2	Groups.....	28
6.3	Automations	29
6.3.1	Sequences	29
6.3.2	Home status	30
6.4	Measures	31
6.4.1	Measures	31
6.4.2	Subscriptions	31
6.5	Managing user rights	32
6.6	Configuration	32
7	LIST AND DETAILS OF DEVICES	33
7.1	KNX devices.....	33
7.1.1	Comfort	33
7.1.2	Access security	34
7.1.3	Sensors	35
7.1.4	Energy	35
7.1.5	Generic.....	36
7.1.6	Network	36
7.2	Cameras	36
7.3	IOT devices.....	37
7.3.1	Philips Hue.....	37
7.3.2	Sonos	37
7.3.3	Netatmo.....	37
7.3.4	Tado	37
7.4	Additional connectivity control point	38
7.4.1	Alexa	38
7.4.2	Google Home.....	38
7.4.3	IFTTT.....	38
7.5	HEMS.....	39
7.5.1	Hager flow	39

1 INTRODUCTION

1.1 Purpose of the document

The purpose of this document is to familiarise the domovea server installer with the configuration interface. This document sets out the steps for the installer to perform this configuration. To do this, the following conditions are generally required:

- the physical installation must be carried out,
- the server must be connected to the Internet via a router with the DHCP server function activated,
- the installer must be equipped with a mobile device (smartphone, tablet, PC) connected to the same network as the server,
- the installer must have a company account on the myHager portal.

Note: We strongly recommend the installer has their own DHCP router (Wifi + 3G/4G) to perform the configuration and tests on the system locally (via Wifi) or over the Internet (via 3G/4G).

1.2 General information on the KNX installations

A KNX installation is an electrical installation in which products communicate between themselves via a wired bus or radio to send or receive commands.

A KNX installation comprises different types of products that can be classed:

- According to their connection with the KNX bus:
 - Wired products: they are connected to the KNX bus by a cable that meets the KNX specifications.
 - Radio products: they are connected to the bus by a radio connection that meets the KNX radio specifications. The radio communication can be:
 - a) One-way: the products are senders only.
 - b) Two-way: the products are both senders and receivers.
- According to their function in the installation
 - Input products: they send commands (push-buttons, switches, motion detectors, etc.). An input product can have several input channels: push-buttons with several switches, etc.
 - Output products: they receive commands and activate the connected applications (lighting, roller shutters, etc.). An output product can have several output channels: lighting output module with 6 channels to run 6 lighting circuits, etc.
 - Systems products: they are necessary for the correct operation of the installation: power supply to the bus, wired bus/radio bus media coupler, etc.

TJA670 domovea Basic

TJA470 domovea Expert

2 GENERAL DESCRIPTION

2.1 Introduction to the system

domovea is the command and display software for KNX and IoT installations. It enables access to all of the home automation functions from the computer terminals (smartphone, tablet, PC, etc.) in the home. In addition to the usual controls, there are new functions for comfort and security: triggering sequences (sequence of programmed or immediate actions), changing the configuration of the house according to events or periods, using images to visualise the correct execution of past or current commands, with a single click.

2.2 System overview

The domovea system is comprised of three modules:

- The Server: A TJA670 or TJA470, a physical interface between the KNX bus and the local network in the home.
- The Client: This software is the client interface. It must be installed on a smartphone, tablet or PC.
- The Configurator: This software is used to configure and program the client interface. It enables access to the server from a PC, smartphone or tablet via the **hager Pilot** application or a web browser.

The following diagram describes the physical architecture of a domovea installation:

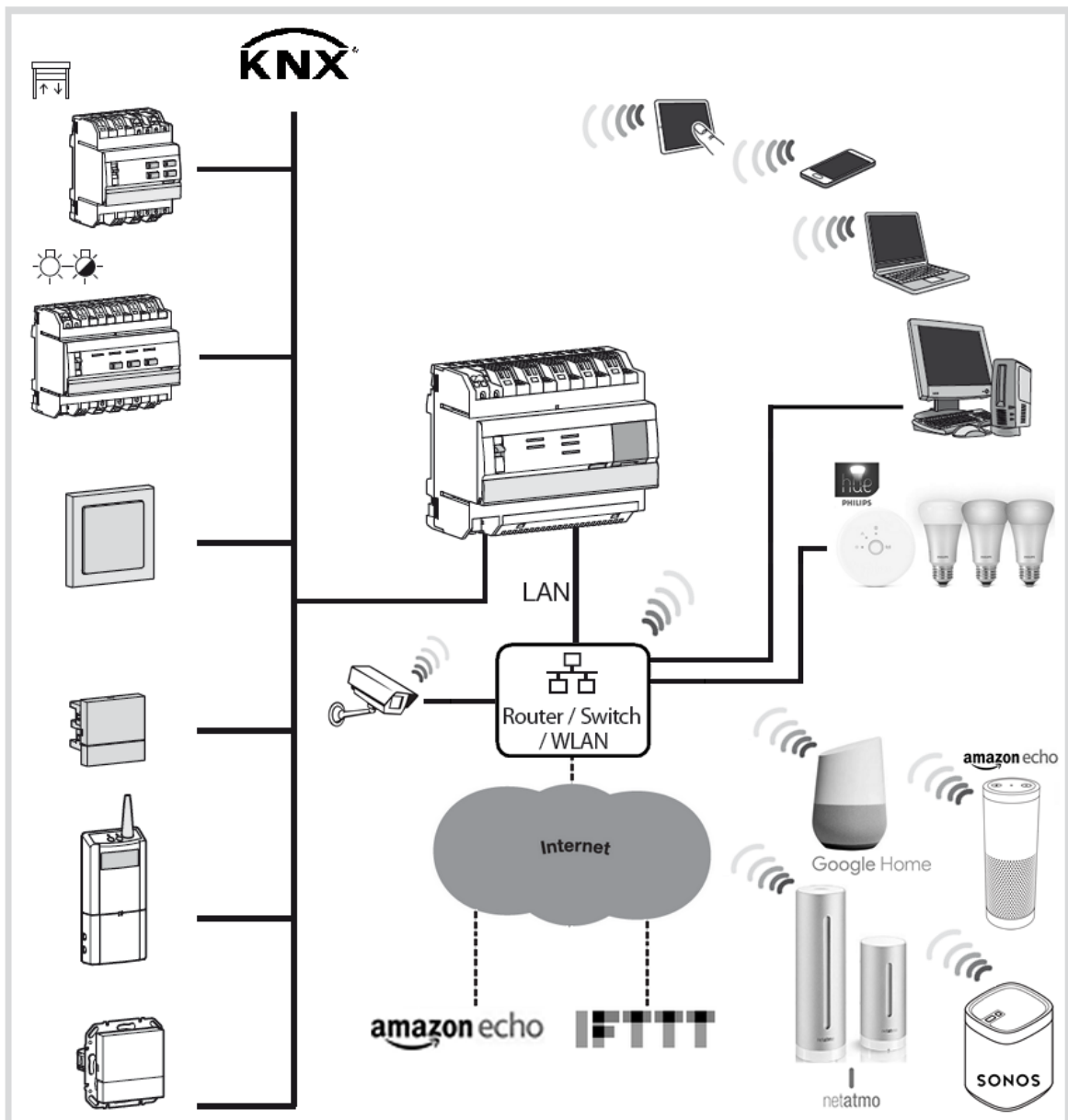

TJA670 domovea Basic

TJA470 domovea Expert

2.3 The domovea solution

The domovea server has 2 solutions:

- domovea basic, offering basic features
- domovea expert, offering more advanced features

Below is a summary table:

Function	TJA670 (domovea basic)	TJA470 (domovea expert)
Integrated KNX Easytool	Yes	Yes
Number max. of KNX and IoT appliances	500	500
Number max. of IP cameras	5	50
Google, Alexa, IFTTT services	Yes	Yes
Number of user sequences (client)	50	50
Number of advanced sequences (configurator)	No	100
User rights management	Yes	Yes
User personalisation	Yes	Yes
Installer and client remote access	Yes	Yes
KNX / IP bridge	Local access only	Local and remote access
Regulation – Number of Thermostat	No	10
Doorphone integration	No	Yes

i The KNX / IP bridge allows parameterization of the KNX installation with ETS software over an IP connection.

2.4 Introduction to the domovea TJA670-TJA470 server

2.4.1 The configuration server

The server is a piece of equipment that creates a link between an IP environment and the KNX bus systems. It involves the use of two applications, the first being the Hager configuration application, Pilot, and the second being the domovea application for the end user.

The product is connected:

- on the one hand by a KNX bus via a connector **13**;
- on the other hand by a local IP network via one of the two Ethernet ports **15** **16**.

OS compatibility:

Applications for Hager Pilot and domovea can be downloaded from the respective stores (App Store, Google Play Store). There you will always find an up to date description of the operating system version from which the application can be used.

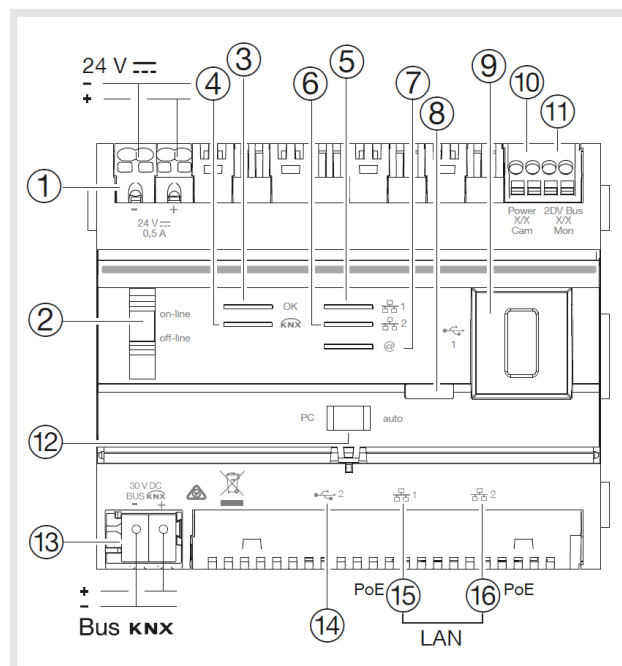

TJA670 domovea Basic

TJA470 domovea Expert

The following table summarises the meaning of each LED

LED function	LED ref	Status	Description
Power	③	Off	No power
		Blinking green	Product start-up phase
		Green light is on	Product on
		Blinking red	Product powered by reserve (10 s. max.)
		Red light is on	Software loading error
Ethernet 1 and 2	⑤and⑥	Off	No network (or operating on power reserve (10 s. max.))
		Blinking green	No DHCP server detected, operating on fallback IP address
		Green light is on	Network detected and IP address allocated
		Red light is on	IP address conflict
		Blinking red	Waiting for IP address allocation
Remote access	⑦	Off	No remote connection (deactivation via software)
		Blinking green	Attempt to establish remote connection
		Green light is on	Remote connection operational
		Red light is on	Error in establishing remote connection

2.4.2 Software version update for the domovea server

i It is mandatory to update the domovea server software version before any first use.

There are 2 ways to update:

Automatic: Configuration tool connector in an Internet box. Connection to the network and the remote server is made automatically for the update (see Chapter [5.2.1.1 Update](#))

Manually: The update file is available on the Hager site.
 To update the domovea server software version:

- Take a blank USB key.
- Copy the update file to the USB key,
- Insert the USB key into the USB ports of the configuration server. The "OK" LED flashes for approximately one minute then remains on.
- Remove the USB key.

The server is updated with the new software version.

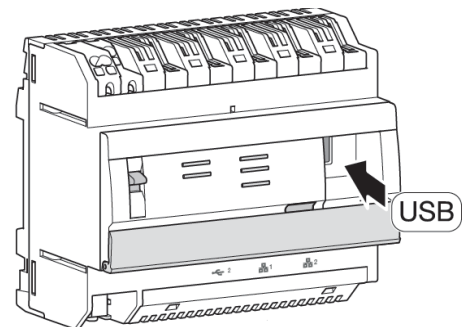

TJA670 domovea Basic

TJA470 domovea Expert

2.4.3 Auto/Router functionality

The 2 Ethernet ports can be used interchangeably to connect the server to the local network. These 2 ports are 2 switched ports connected to the same logical interface on the TJA670-TJA470 (switch).

Switches		Ethernet port behaviour			
COMⓈ	SEL	Ethernet Port 1	Ethernet Port 2	Internet connection status	Bus status KNX
Online	Auto	<p>This is the normal operating mode for the TJA670- TJA470 when it is connected to an external router (ISP box).</p> <p>The interface is configurable with a DHCP client or fixed IP address.</p> <ul style="list-style-type: none"> - With a client DHCP (default factory set mode), the server waits for an IP address coming from a DHCP server connected to the network (the router). If, after 40 seconds, no address has been attributed, the server automatically takes the fallback address: 192.168.0.253 / 255.255.255.0. - With a static IP address, the server immediately recognises the settings defined in the “Configuration-Network” tab in the configurator settings menu: <ul style="list-style-type: none"> - Interface IP address - Sub-network mask - Default server address <p>N.B. with a fixed IP address, the module does not automatically switch to the fallback address if there is an IP address conflict on the network (other device already using the IP address defined).</p>		active	active
	PC	<p>To use when a PC is directly connected to the server. This mode activates the DHCP server built into the module. The 2 ports are interchangeable and configured with the following parameters:</p> <ul style="list-style-type: none"> - Interface IP address: 192.168.0.253 - Sub-network mask: 255.255.255.0 - Default server address: 192.168.0.1 - range of IP addresses that can be attributed by the TJA670-TJA470 DHCP server: 192.168.0.10 to 192.168.0.50 		active	active
Offline	Auto / PC	<p>This mode is a fallback mode in which the server interface is configured in DHCP client mode.</p> <ul style="list-style-type: none"> - If no IP address is attributed by a DHCP server after a wait of 40 seconds, the server automatically assumes the following fallback address: 192.168.0.253 / 255.255.255.0. 		inactive	inactive

TJA670 domovea Basic

TJA470 domovea Expert

2.4.4 Technical specifications

KNX power supply	KNX bus TBTS 30 V $\overline{\text{---}}$
Consumption on the bus line	10 mA max - 30 V $\overline{\text{---}}$
External power supply ^① or PoE ^⑮ ^⑯	24 V to 30 V $\overline{\text{---}}$ via Hager SELV power supply TGA200 type or via PoE
Standard/Standby consumption on the 2-wire bus	35 mA / 12 mA - 24 V $\overline{\text{---}}$
Max consumption on the auxiliary power supply	760 mA max - 24 V $\overline{\text{---}}$
Standby consumption on the 24 V Ethernet and non-connected USB	330 mA
Maximum dissipation (24 V output)	10 W without USB, 15 W with 2 USB max
PoE power supply consumption	PoE Class 3: 13 W
Ethernet network communication	2 x 100/1000 BaseT
Max 24 V power cable length	10 m
Bus connection ^⑩ ^⑪	0.2 – 1.5 mm ²
Power supply socket ^①	0.75 - 2.5 mm ²
Ethernet/IP network socket ^⑮ ^⑯	2 x RJ45
Operating T°	-5°C to + 45°C
Storage T°	- 20°C to + 70°C
Width (REG)	6TE
Dimensions (L x H x D)	106 x 90 x 67 mm
USB2 Interface ^⑨ ^⑭	2
Installation method	DIN rail (EN60715)
Operating altitude	< 2000 m
Pollution level	2
Surge voltage	4 kV
Protection ratings	<ul style="list-style-type: none"> • box: IP20 • box under faceplate: IP30
Impact resistance	IK04

TJA670 domovea Basic

TJA470 domovea Expert

2.5 Software installation

2.5.1 Installing the Hager Pilot application

- **On a mobile device:**
 - find and download the **hager Pilot** application from the *App Store*® or *Google Play Store*®,
 - install the **hager Pilot** application; an icon will appear on the screen.
- **On Windows PC:**
 - find and download the **hager Pilot** application from the Hager website,
 - install the **hager Pilot** application; an icon will appear on the screen.



hager Pilot



hager Pilot

2.5.2 Launching the Hager Pilot application

Locally connect the mobile or stationary equipment to the network on which the server is connected

- launch the hager Pilot application. A selection window of servers is displayed,
- select server TJA670-XXXXX or TJA470-XXXXX.

If the server does not appear on the list,

- click **Add a server**,
- add the server by entering either:
 - The IP address
 - The name of the server (TJAxxx-xxxxxx)
 - The serial number

i To add a remote server (not connected to the local network), you must enter the serial number of the device. This is visible in the **Remote Access** menu where the serial number is contained in the address (For example: <https://kj4f6s8kvcywvd.domovea.com>, the serial number will be **kj4f6s8kvcywvd**).

You are connected to the server.

i For more information, please see tutorial **1 - Start and set up a domovea installation with Hager TJA670-TJA470** at www.hager.com/domovea.

2.5.3 Accessing the configurator without using hager Pilot

In some cases, the configurator must be accessed directly without using the hager Pilot application.

- **Using the web browser**

To connect in this way, the server IP address must be known: it is the address given by the local DHCP server if the switch ⑫ is set to “auto” (if the switch ⑫ is set to “PC”, launch the web browser and enter the default gateway IP address: 192.168.0.253).

i We recommend to use the **Google Chrome** or **Safari** as default web browser on the device.

- **Using the file browser**

The server supports the UPnP function. UPnP devices are displayed in Windows under the Network section. Double-clicking on the TJA670 or TJA470 icon opens the configuration interface in the web browser.

TJA670 domovea Basic

TJA470 domovea Expert

2.5.4 Logging onto the server

At this stage of installation, you can only log on with the administrator profile as only this account is active. The administrator access information is as follows:

- User name: **admin**
- Password: **1234**
- Click **Login**

For security reasons, the system requests a new administrator password

The new password must be created according to the following rules :

- ✓ contains more than 8 characters,
- ✓ contains at least one lower case letter,
- ✓ contains at least one upper case letter,
- ✓ contains at least one special character,
- ✓ contains at least one number.

 This password is the new password for the local server Administrator account.

2.6 Using the system

To use mobile devices or a PC with the server, they must have the domovea application

2.6.1 Installing the domovea Client application

The application is designed to operate with a tablet or smartphone.

- **On a mobile device:**
 - find and download the **domovea** application from the *App Store*[®] or *Google Play Store*[®],
 - install the **domovea** application; an icon will appear on the screen.
- **On Windows PC:**
 - find and download the **domovea** application from the Hager website,
 - install the **domovea** application; an icon will appear on the screen.



domovea



domovea

2.6.2 Launch the domovea application

Locally connect the mobile or stationary equipment to the network on which the server is connected

- launch the **domovea** application; a selection window of servers is displayed,
- select server TJA670-XXXXX or TJA470-XXXXX.

You are connected to the server via the **domovea** application.

2.6.3 Log in using the domovea application

At this stage of installation, you can only log on with the administrator profile as only this account is active. The administrator access information is as follows:

- User name: **admin**
- Password: **Administrator password (entered when logging in with hager pilot)**
- Click **Login**

 For more information, please visit www.hager.com/domovea. - Discover the domovea application

TJA670 domovea Basic

TJA470 domovea Expert

i The administrator account is valid with its new password of at least 8 characters until the handover has been completed.

2.6.4 What to do if you lose your password

If the passwords are lost, it is possible to reconnect to the server **locally only**.

i This procedure is only possible via a web browser

- Connect the device supporting your web browser to the same local network as the server.
- Start the web browser and enter the server address (<http://server-name/>, <http://server-name.local/>, <http://IP-address/> or <http://192.186.0.253> in case of default static IP address)
- Enter the login **admin** and click **Next**

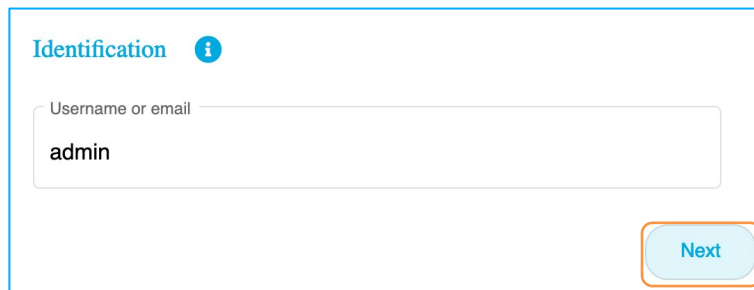

Identification **i**

Username or email

admin

Next

- Click on **Forgot password?**

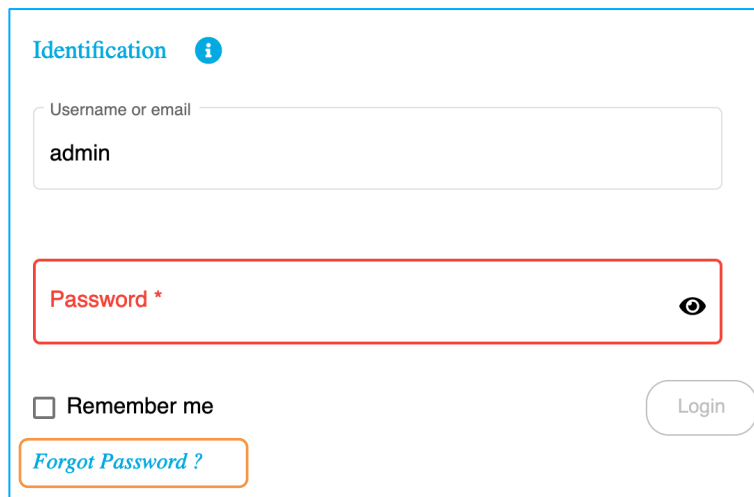

Identification **i**

Username or email

admin

Password *

Remember me

Login

[Forgot Password ?](#)

An information window will appear, to describe the steps to follow to reset the password.

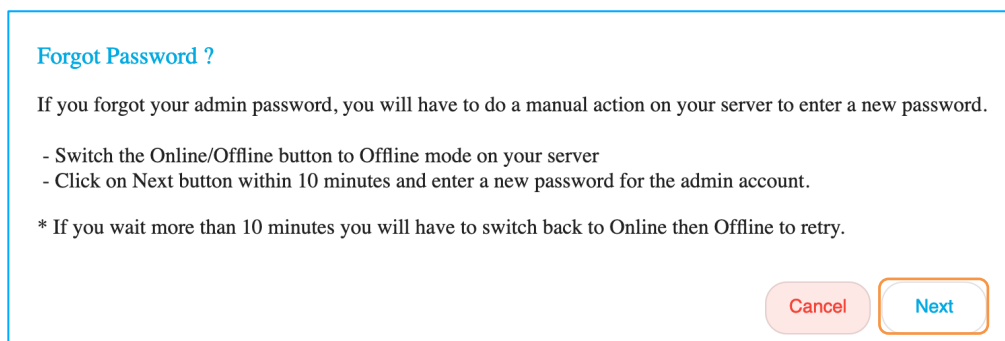

Forgot Password ?

If you forgot your admin password, you will have to do a manual action on your server to enter a new password.

- Switch the Online/Offline button to Offline mode on your server
- Click on Next button within 10 minutes and enter a new password for the admin account.

* If you wait more than 10 minutes you will have to switch back to Online then Offline to retry.

Cancel Next

TJA670 domovea Basic

TJA470 domovea Expert

- Toggle the server switch to the **off-line** position.
- Click on **Next**

i You have 10 minutes to enter the new password.

- Enter the new password for the administrator account.
For security reasons, the new password must be created according to the following rules :
 - ✓ contains more than 8 characters,
 - ✓ contains at least one lower case letter,
 - ✓ contains at least one upper case letter,
 - ✓ contains at least one special character,
 - ✓ contains at least one number.

Admin security

Please initialize a secure password for admin account

New password *

.....

✓ Number ✓ Uppercase ✓ Lowercase ✓ Special character ✓ 8 or more characters

Confirm password *

.....

Confirm

- Click on **Confirm**

i This password is the new password for the local server Administrator account.

The access to the settings is possible again.

To restore the Internet connection to the server:

- Toggle the server switch to the **on-line** position.

TJA670 domovea Basic

TJA470 domovea Expert

2.7 Connexion KNX IP secure

KNX Secure devices are able to encrypt and decrypt telegrams, thus adding an extra level of security to a KNX installation. This level of security can be used both during the commissioning of KNX installations as for KNX installations at runtime.

There are two types of encryption:

- KNX IP Secure : Telegrams are entirely encrypted and applied only to the KNX IP medium. This encryption must be used for KNX installations using an external IP network such as the Internet.
- KNX Data Secure : Telegrams are partly encrypted and applied to any KNX communication medium. This encryption can be used for the KNX IP medium, but only for the part of the KNX installation that is not exposed to an external IP network.

The procedure below describes how to set up KNX IP Secure with the domovea server.

- i** Before setting up the ETS project, the following conditions must be fulfilled:
- The ETS software must have at least version 5.7.4 (v1093).
 - The first connection to the KNX bus must be made in a local network via the domovea server.

Installing the application:

- Download the KNX product data file (knxprod) depending on the version of the domovea server
 - **PS_TJA470_V101_T1.KNXPROD** for version TJA470
 - **PS_TJA670_V102_T1.KNXPROD** for version TJA670
- Start ETS
- In the **Bus** section, select the interface corresponding to the local server.
- Open the concerned ETS project and select the server version from the product catalogue.
- Installing the domovea server in the project.

- i** If the project is not yet secured at that time, ETS will ask to enter a new password.

- Add the KNX certificate of the device using the QR code or manually.

- i** the KNX certificate of the device can be found in the **Interface** section of the domovea server.

The screenshot shows the 'Interface' configuration page for the domovea server. The 'KNX certificate' field is highlighted with an orange box, indicating where to add the device's certificate. Other fields include Device name (TJA470-F13154), KNX address (1.1.210), KNX serial number (0009:FFFF7F55), and MAC Address (00:24:C6:F1:31:54). There are 'Save' and 'Close' buttons at the bottom.

- Enable **Secure Commissioning** in the device properties in the **Settings** tab.
- Perform a full download of the device.

TJA670 domovea Basic

TJA470 domovea Expert

i Check that the **slow bus communication** option in the project details is unchecked so that the download is done correctly.

The screenshot shows the 'Details' tab of a software interface. It contains various fields for project configuration. The 'Compatibility' section has a checkbox labeled 'Use slowed bus communication' which is currently unchecked and highlighted with an orange border. Other fields include Name, Project Number, Contract Number, Start Date (21/08/2020), End Date, Status (Editing), and Comment.

Your KNX project is now password protected.
This commissioning password can be found in the device properties under the **IP** tab.

The screenshot shows the 'Properties' dialog box with the 'IP' tab selected. The 'Commissioning Password' field is highlighted with an orange box. Other fields include 'Obtain an IP address automatically' (selected), 'MAC Address' (00:24:C6:F1:31:54), and 'Multicast Address' (224.0.23.12).

You can now activate your secured service with the commissioning password and use your local interface.

The screenshot shows the ETS software interface. The 'Discovered Interfaces' table is visible, with the following data:

Interface Name	IP Address	MAC Address
1.1254 domovea basic	192.168.0.19.3671	00:24:C6:F1:14:48
1.1210 domovea expert	192.168.0.21.3671	00:24:C6:F1:31:54
15.15.255 Heger KNX Gateway	192.168.0.20.3671	00:24:C6:F1:40:4C
15.15.255 Heger KNX Gateway	192.168.0.14.3671	00:24:C6:F0:5E:26

The 'IP Tunneling' properties panel on the right shows the following configuration:

- Name: domovea expert
- Host Individual Address: 1.1.210
- Individual address: No specific address
- IP Address: 192.168.0.21
- Port: 3671
- MAC Address: 00:24:C6:F1:31:54

TJA670 domovea Basic

TJA470 domovea Expert

2.8 Connection using the KNX / IP bridge

The domovea server is used to connect via IP to the KNX bus for product configuration by ETS. It uses the KNXnet / IP standard and establishes communication between KNX lines and data networks using the Internet Protocol (IP).

Access to use the server as an IP bridge can be done locally or remotely.

The remote connection can only be made with the TJA470 Domovea Expert server.

2.8.1 Connection with a local network

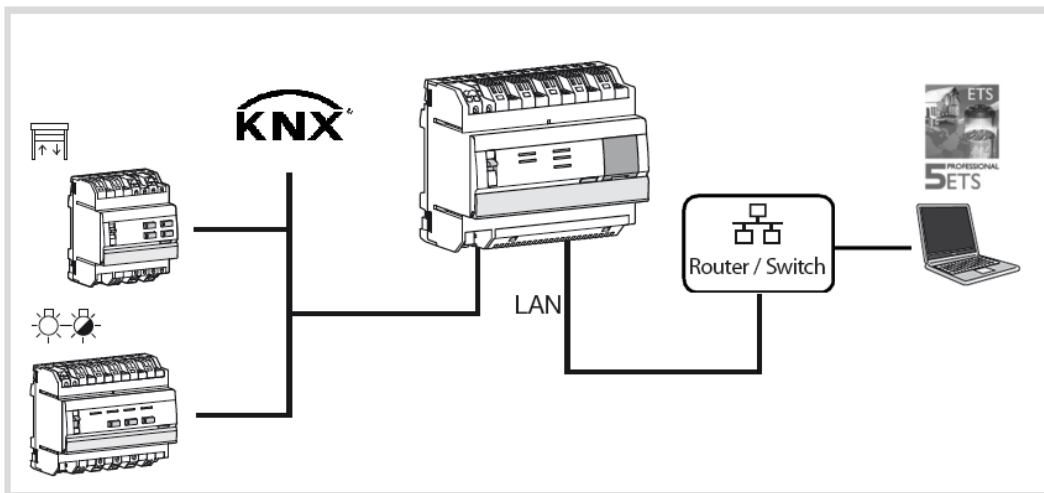

With ETS, the domovea server appears as a communication interface with the KNX bus.

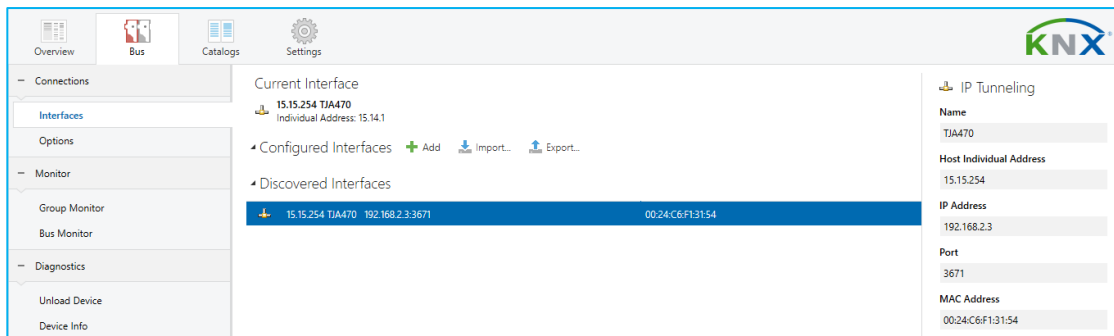

TJA670 domovea Basic

TJA470 domovea Expert

2.8.2 Connection with a remote network (Only with TJA470 Domovea Expert)

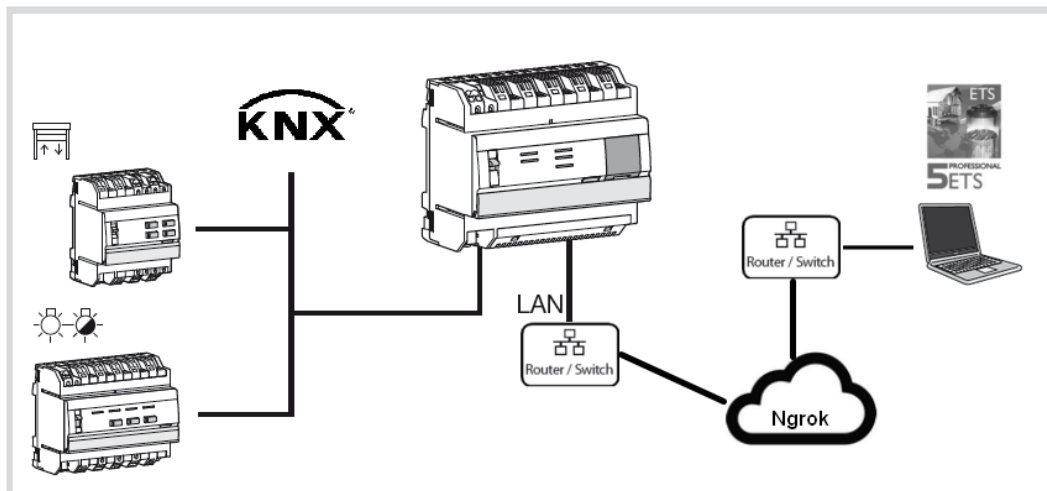

In order to establish a remote connection using the KNX / IP interface, the following conditions must be fulfilled:

- Administrator rights are transferred (see [chapter 5.2.2.1](#))
- Installer access is activated (see [chapter 5.2.2.2](#))
- The KNX/IP secure process is running in the ETS project (see [chapter 2.7](#))
- Remote access is activated (see [chapter 5.2.1.3](#))

Downloading the application:

- Download the **domovea secured proxy app** from knx.org using your KNX account.
- Download the product license for the **domovea secured proxy app**

i Please have your ETS key number (KNX-xxxxxxx) with you, in order to generate a licence for the application during the download.

Installation of the application in ETS

- Insert the ETS licence key
- Start ETS
- Click on the **Apps** section in the lower right corner.
- Select **Compatibility Mode App** to activate the application.
- Restart ETS to enable the application
- Click on the **Apps** section in the lower right corner.
- Click on **+** and select the **domovea secured proxy app x.x.x.x.etsapp** file that you have previously downloaded.
- Restart ETS to enable the application

Installation of the license

- In ETS, click on the License section in the lower right corner.
- Click on **+** and select the **domovea secured proxy app- xxx.license** file that you have previously downloaded.

KNX project

- Open the KNX project secured beforehand
- Select the domovea device
- Enable **Secure Tunnelling** in the device properties in the **Settings** tab
- Go to the Apps tab and select the **domovea secured proxy app**
- Enter the email address and password for your **My Hager** account
- Select from the list the domovea server set up in your project and click **Start**.

TJA670 domovea Basic

TJA470 domovea Expert

The remote connection is now established.

i To complete the connection, make sure that the connection to the remote interface is valid.

Update	Interface	Remote access
Time management	domovea	easytool
Remote access	https://support.hager.com/en/guides/1116 domovea.com	
	<input checked="" type="checkbox"/> Use of remote access	
	● ETS remote KNX/IP interface i	
ETS KNX/IP URL	<input type="text" value="http://127.0.0.1:3671"/>	
	<input type="button" value="Save"/> <input type="button" value="Close"/>	

On the **Interface** tab, you can reset the settings for the KNX connection by clicking on **Reset KNX/IP interface**. If the KNX IP Secure process was performed before the reset, simply reload the participant at ETS level to recover the service.

Selection of the interface for remote connection

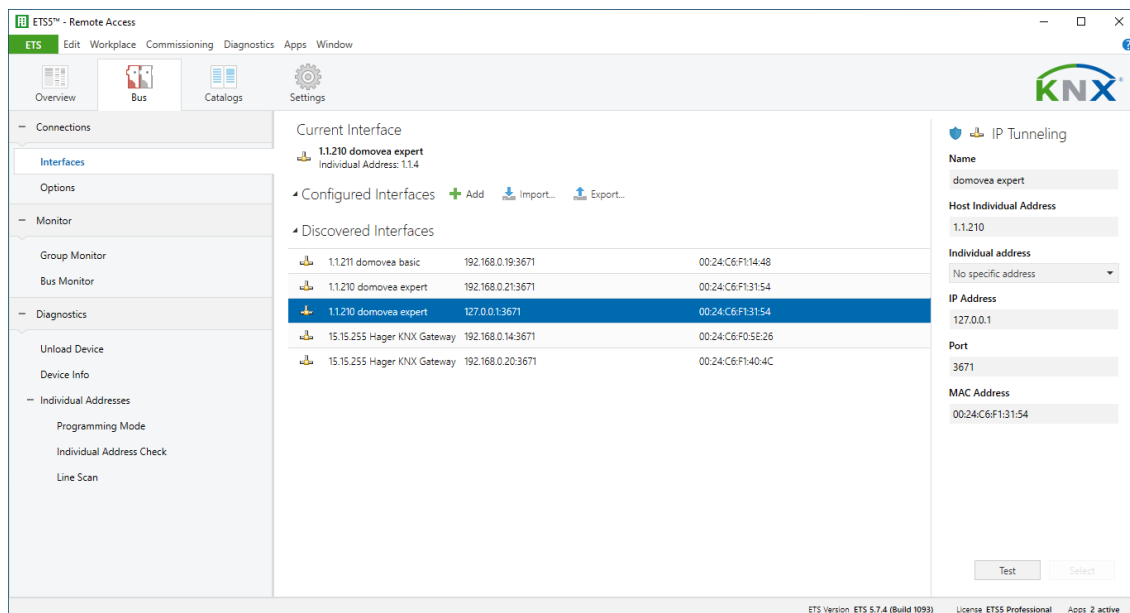

i For more information, please see tutorial **2-Connect domovea expert to ETS using KNX IP tunneling** at www.hager.com/domovea.

TJA670 domovea Basic

TJA470 domovea Expert

3 FIRST USE

After selecting the server and during first use, there are 3 ways of starting the installation:

- by creating a new project,
- by importing a backup file,
- by relearning the installation,

3.1 New project

This enables the creation of a new installation authorising a manual configuration of domovea.

- click on **New project**,
- enter the name of the project

*Note: As an option, information related to the installation can be entered by clicking on **Client information***

 For more information, please see tutorial **3 - Create a new domovea project using Hager Pilot and the easytool** at www.hager.com/domovea.

3.2 From a backup file

This enables the creation of a new installation from a backup file.

There are 5 file formats:

Configuration	File extension	Backup file
Easytool	*.txa	Installation configured with Easytool (TXA100)
TX100	*.txh	Installation configured with the TX100 configuration tool
domovea 1	*.ddb	domovea 1* configuration
domovea 2	*.hbox	domovea 2* configuration
ETS	*.knxproj	Installation configured with ETS (KNX configuration software)*

* Using the Easytool configuration tool is no longer possible.

- click **Import**,
- select the backup file.

 For more information, please see tutorial **4 - Import a .hbox project in domovea with Hager Pilot** at www.hager.com/domovea.

3.3 Using relearning

This enables the creation of a new installation when there is no installation backup. This is possible by performing relearning on the installation.

Note: Only products known to the Easytool configuration tool will be included.

- click on **Relearn**.

TJA670 domovea Basic

TJA470 domovea Expert

4 MY PROJECT

Project domovea basic TJA670

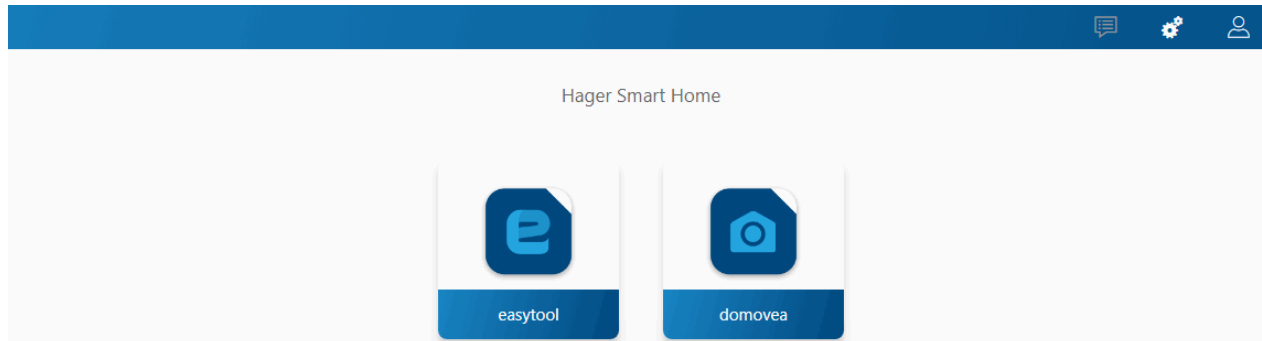

Project domovea expert TJA470

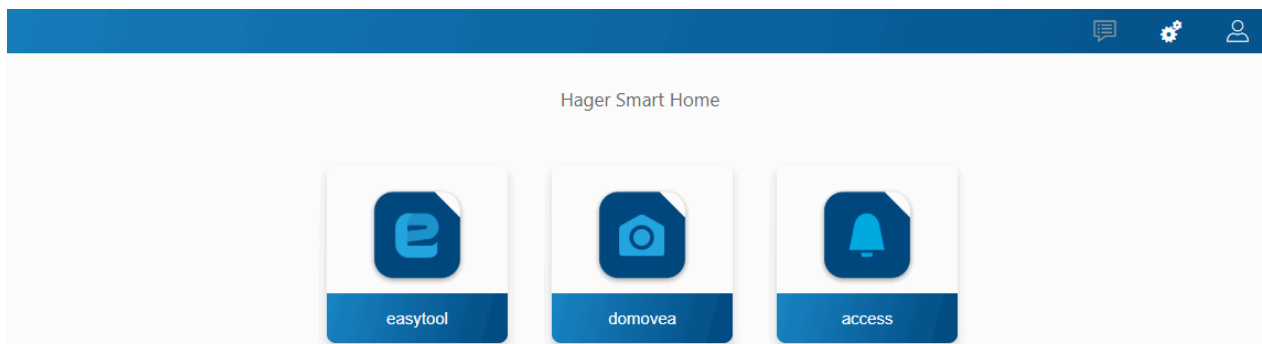

This enables the project to be configured:

- Using the Easytool configuration tool:
 - click on the **Easytool** symbol

A KNX product configuration window appears, enabling the installation to be configured.

i For more information, refer to the installer manual for the TXA100 configuration tool

- Using the Access configuration tool (**only with TJA470 Domovea Expert**):
 - click on the **Access** symbol

A configuration window appears, enabling the intercom application to be configured.

i For more information, refer to the TJA510 Gateway Configuration Manual

- Using the domovea configurator:
 - click on the **domovea** symbol

A configuration window appears, enabling the domovea client application to be configured.

TJA670 domovea Basic



TJA470 domovea Expert

5 RELATED FUNCTIONS IN THE MENUS

5.1 Account configuration

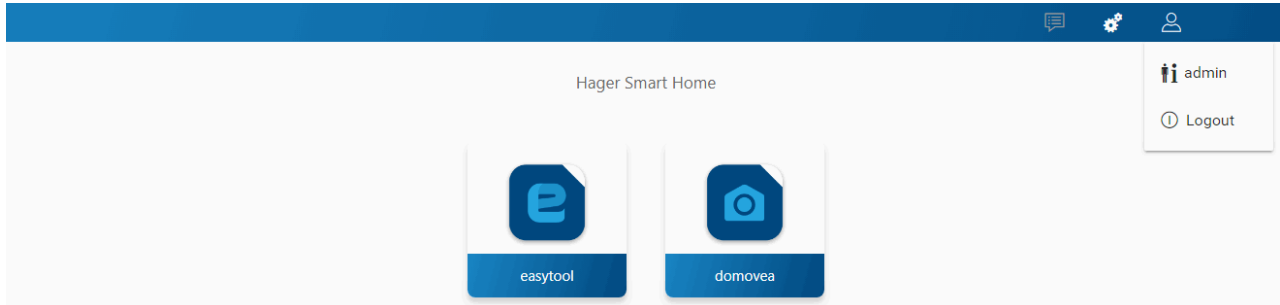
This enables the connected user account to be configured. When you are connected, the general settings are accessible from the drop-down menu on the top right.



- click on , a drop-down menu appears,
- click on .

A window appears:

- the **Activation** field activates or deactivates the user profile,
- a **Description** free field enables information about the user to be added,
- an **Edit password** button enables the user password to be changed,
- the **Language** field enables the configurator language to be changed when the user connects to their profile,
- the **Time format** field enables the time format to be changed,
- click on **Save** to confirm your choices.

5.2 Settings

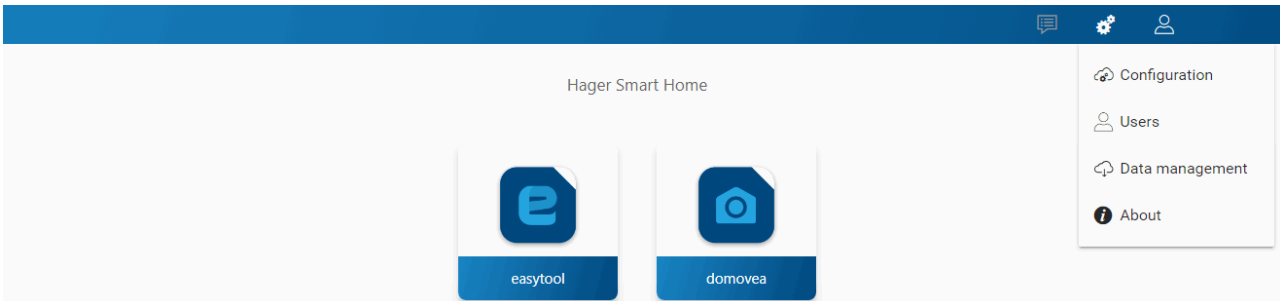

5.2.1 Configuration

This enables the product to be configured. When you are connected, the general settings are accessible from the drop-down menu on the top right.

- click on , a drop-down menu appears,
- click on **Configuration**.

5.2.1.1 Update

Click on **Update** to view the software versions:

- the server version (application software version),
- the BSP version (motherboard software version),
- the JVM version (JAVA virtual machine software version).

Under **Update** to select the update mode:

- **Automatically install updates**: the new software version will be installed automatically (default value: active),
- **Install update**: the new software version is installed manually,
- **Check for updates**: check whether a new software version is available,
- **Never check if updates are available**: the configuration server does not check whether a new software version is available (default value: not validated),
- click on **Save** to confirm your choices.

TJA670 domovea Basic

TJA470 domovea Expert

5.2.1.2 Interface

Click on **Interface** to view:

- the **Device name**, which you can change, if necessary,
- the **KNX address** of the configuration server, which you can change if necessary,
- the **KNX Certificate** of the configuration server, enabling installation in KNX Secure,
- the **KNX Serial Number** of the configuration server the **MAC address** of the configuration server,
- the **IP detection**: automatic or manual (depending on requirements),
- the **DNS server**: automatic or manual (according to requirements),
- click on **Save** to confirm your choices.

Click on **Reset KNX/IP Interface** to reset the KNX connection settings.

i If the KNX IP Secure process has been completed before the reset, simply reload the participant at ETS level to recover the service.

5.2.1.3 Remote access

Remote access enables connection to the configuration server and the client from a device connected to the Internet.

Click **Remote access** to view:

- the **Remote address** field: the http address link of the configuration server,
- **Use of remote access** (default value: activated): enables the installer to intervene remotely,
- click on **Save** to confirm your choices.

You can connect remotely using:

- hager Pilot or domovea client.
 - select server TJA670-XXXXX or TJA470-XXXXX.

If the server does not appear on the list,

- click **Add a server**,
- add the server by entering either:
 - The IP address
 - The name of the server (TJAxxx-xxxxxx)
 - The serial number

i To add a remote server (not connected to the local network), you must enter the serial number of the device. This is visible in the **Remote Access** menu where the serial number is contained in the address (For example: <https://kj4f6s8kvcywvd.domovea.com>, the serial number will be **kj4f6s8kvcywvd**).

- a device connected to the Internet
 - launch the **WEB** browser,
 - in the address box, enter the pathway for remote access (for example: <https://kj4f6s8kvcywvd.domovea.com>),
 - the WEB browser launches at the login page. Enter the **User name** and **Password**.

i For more information, please see tutorial **5 – Enable remote access with easytool and with domovea** at www.hager.com/domovea.

TJA670 domovea Basic

TJA470 domovea Expert

5.2.1.4 Time management

Click on **Time management** to view:

- the **time zone** that can be selected from the drop-down list, for displaying the date and time at the client level.
- the **Latitude** and **Longitude** of the time zone, to set the time of sunrise and sunset
- the Synchronisation with an Internet server (click **Yes** or **No** depending on requirements). By default, the configuration server is synchronised with the online **Time server** (NTP network):

Yes	No
Time server: enter the name of the time server (default: pool.ntp.org)	Date: enter the current date
	Time: enter the current time

- the **periodical dispatch of the KNX frame** allowing the date and time to be broadcast on the network (deactivated by default)
- click on **Save** to confirm your choices.

5.2.1.5 domovea

Click on **domovea** to view:

- the **KNX address format**: Enables selection of the address format of KNX groups (**1 Level - 2 Levels - 3 Levels**).
- the **Currency symbol** : Enables the currency to be defined
- click on **Save** to confirm your choices.

5.2.1.6 Easytool

Click on **Easytool** to set the following options:

- click on the **Enable configuration facilitation of input channels (Rocker function)**: Depending on the function type selected, the system will default to the additional function on the second input.
- click on the **Activate automatic discovery** field: the installation can be automatically scanned to discover a new product.
- click on the **Activation period** field: defines the duration between 2 automatic scans (default value: 10 min.)
- click on the **Activate Auto links** field: allows you to view the automatic links of the installation for products with this function.
- click on **Save** to confirm your choices.

5.2.2 Users

This manages the different administrator and user accounts. There are two types of operation:

- The transfer of administrators' rights
- The creation and management of additional accounts

5.2.2.1 The transfer of administrators' rights

Once the installer has finished configuration, he must send the administrators' rights to the owner.

- click on , a drop-down menu appears,
- click on **Users**.

A window opens, inviting you to transfer the rights:

- enter the email and password of the myHager account,

 If you do not have a MyHager account, you can create one at this level.

- enter the owner's email address to finalize the handover
or
- confirm that you are the owner of the installation (MyHager account).

TJA670 domovea Basic

TJA470 domovea Expert

After entering the email address, a confirmation email is sent to the owner's address containing an activation code. This code must be entered in the **domovea client** application for confirmation.

Note: Following the transfer of rights, the Admin account is no longer valid.

 For more information, please see tutorial **6 – Complete the handover process for a domovea installation** at www.hager.com/domovea.

5.2.2.2 The creation and management of additional accounts

Once the transfer of rights has finished, it is possible to create and manage additional accounts.

- click on , a drop-down menu appears,
- click on **Users**.

To create a new account:

- click on **New**,
- enter the email and password of the account,
- select the type of account: Installer – Referent user – Restricted user,
- select the account language,
- click on **Save** to confirm your choices.

- For an Installer account, a confirmation email is sent to the installer's address containing an activation code. This code must be entered in the **domovea client** application for confirmation.

To modify an existing account:

- select the account to modify,
- click on **Modify**,
- carry out the desired modifications,
- click on **Save** to confirm your choices.

 For more information, please see tutorial **8 – Add a new user in domovea** at www.hager.com/domovea.

5.2.3 Data management

This manages the configuration archives of domovea projects. The configuration archive files are stored in the server memory and can be downloaded by the user as an external backup.

- click on , a drop-down menu appears,
- click on **Data management**.

5.2.3.1 Data management

Click on **Installation reset** to erase your application data and to reconfigure your installation (The data of users, handover status, backups and settings will be conserved).

Click on **Reset handover** to reset all your users and restart a new handover process. Only configuration will be conserved, all personal data will be deleted (Image/Video, measurements, background in client application, current save points). You'll be disconnected and need to connect with the default account (admin).

Click on **Factory reset** to delete all the data. Your server will be in the factory state (An internet connection will be needed for an automatic update to the latest version).

The **reference Savepoint** corresponds to the last installer backup. This backup is launched as a result of the transfer of rights and cannot be deleted. It restores the system to the point it was at when it was received by the final client.

- click on **Restore** to restore the reference configuration from the server,
- click on **Download** to backup the project to a file (*.hbox).

The **Savepoint** enables regular backup of the installation.

- click on **Save** to carry out a backup,
- click on **Restore** to restore the backed-up configuration from the server,
- click on **Download** to backup the project to a file (*.hbox).

TJA670 domovea Basic

TJA470 domovea Expert

Export all your data allows you to save all the personal data of your installation. The file will be exported in a compressed format (*.zip). It will contain all energy consumption and sensor measurements in CSV format, as well as screenshots and recorded videos.





- click on **Export** to carry out a backup,

 For more information, please see tutorial 7 – **Export personal data from Hager Pilot** at www.hager.com/domovea.

5.2.3.2 Ressources management

The domovea server has an allocated and restricted space to store resources by categories (measurements, photos, videos, ...).

A memory size, allocated to each category, is indicated as described below :

 Default	If the memory used is less than 80% of the allocated memory.
 Warning	If the memory used is between 80% and 90% of the allocated memory. An attention notification is sent to the installation administrators.
 Alarm	If the memory used is between 90% and 95% of the allocated memory. An alarm notification is sent to the installation administrators.
 Critical	If the memory used is more than 95% of the allocated memory. A critical notification is sent to the installation administrators. In this case, no more photos or videos can be recorded and measurements are no longer saved.

The different categories are:

Categories	Sub Categories
Database	Configuration Domovea Measures Database
Media	Archives Media files (camera recordings, ...)
System	Call log System logs
Download	Downloaded files
Security	Security database
Temporary	Temp files

TJA670 domovea Basic

TJA470 domovea Expert

5.2.4 About

In this menu, you will find information on the configuration interface software version, as well as disclaimers.

- click on  **About** to view the domovea software version,
- click on **Close** to exit.

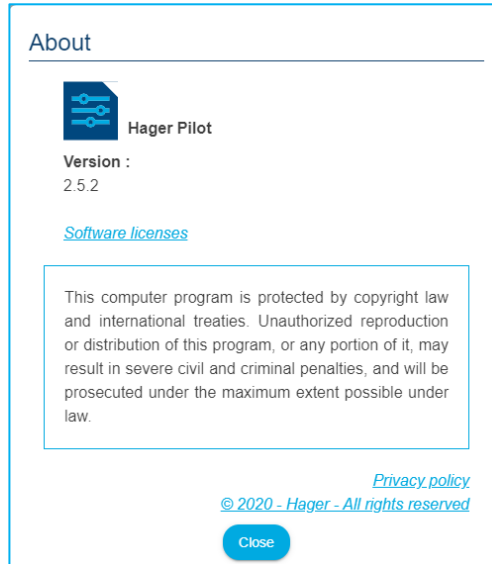

6 MY DOMOVEA INSTALLATION

6.1 Dashboard

The **Dashboard** page can be used when an installation is selected:

- go to **Architecture** to display an overview of the installation elements
 - The number of groups
 - The number of devices
 - The number of valid or invalid automations
 - The number of active or inactive measures.
- to display the non-configured devices
- to display the non-configured automations

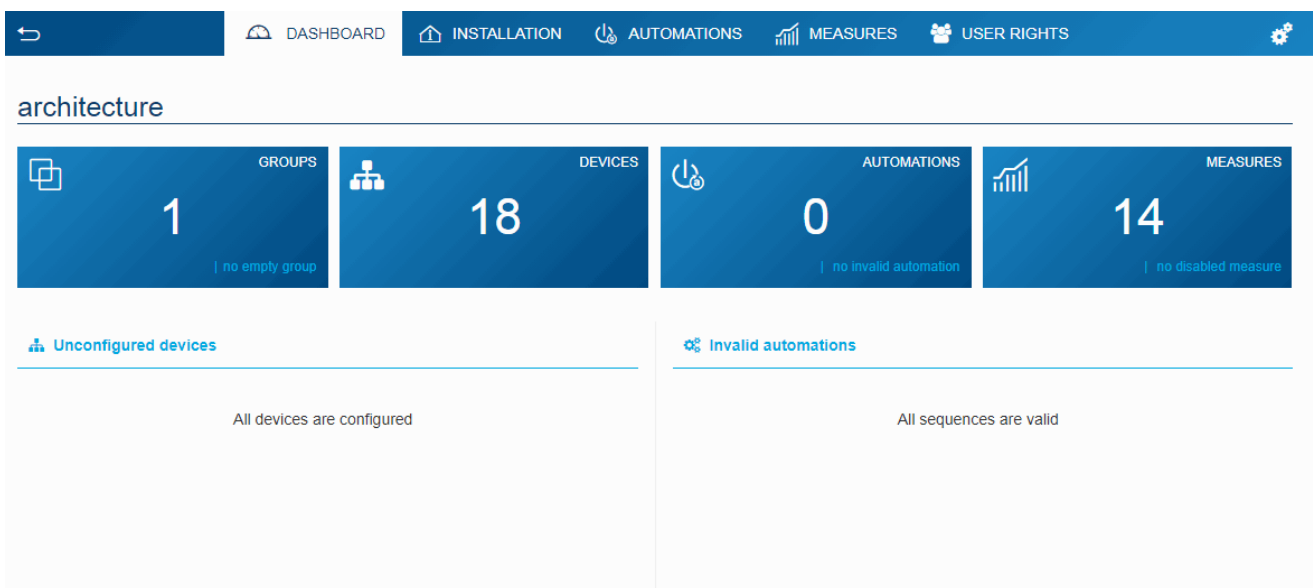

TJA670 domovea Basic

TJA470 domovea Expert

6.2 Installation

6.2.1 Devices

A device is a piece of equipment connected to a part of a KNX installation that can be controlled or viewed via the client domovea, such as lighting, shutters, heating, etc. (maximum 500 devices per installation)

 For products not recognised by the easytool configuration tool, domovea can only collect data from the installation products. It must verify that the KNX products that you wish to add to domovea offer tool formats compatible with the tools of the domovea devices

Click on **New device** to create a device:

- in the left column, select the device type (KNX – Camera- IoT),
- in the right column, select the device according to the type selected.



The device is created.

- configure the properties of the device if necessary,
- add the different group addresses for the KNX devices.

 For more information, please see tutorial **9- Add and configure a KNX device not discovered by easytool** at www.hager.com/domovea.

The domovea server has a presence simulation function. It allows you to control the devices (lighting and shutters only) in a random way giving the impression of being at home during your absence.

Each device can be included or excluded from the presence simulation.

- Click on  to add the device to the presence simulation,
- Click on  to remove the device from the presence simulation,

 For more information, please see tutorial **13- Use the presence simulation function with domovea** at www.hager.com/domovea.

6.2.2 Groups

A group is a part of the installation composed of a room, a building floor, an area or part of a set of rooms, floors or areas (e.g. kitchen, living room, exterior).

The groups comprise the structure of the project (maximum 100 groups per installation)

Click on **New group** to start creating your project's links.

- rename the group directly in the field on the top right.

You can add a description if necessary.

Repeat the operation for each group

Once the groups are created, the devices must be assigned to each corresponding group.

- click on **All devices**,
- select one or more devices from the list,
- click on **Change the Group** at the top of the device list,
- select the group to which you wish to assign the selected device(s).

 For more information, please see tutorial **10 - Create groups in domovea using Hager Pilot** at www.hager.com/domovea.

TJA670 domovea Basic

TJA470 domovea Expert

6.3 Automations

(Only with TJA470 Domovea Expert)

Automations are not available in the configurator with the domovea Basic version (TJA670). They are available in the client application (domogram).

 For more information, please see tutorial **11 - Configure domograms in domovea** at www.hager.com/domovea.

6.3.1 Sequences

Sequences are used to create complex scenarios for executing functions conditioned or not by sensor states.

A sequence is characterized by:

- One or more **triggers**,
- One or more **conditions**,
- One or more **actions**.

A **trigger** makes it possible to evaluate, in a simple and fast manner, an event before carrying out a test of the condition.

Trigger type: on time schedule - Cyclic - On KNX event - On variable change - On device change - On measure change- On service change.

A **condition** allows complex evaluation of different events in a more precise way. It is evaluated only when one of the triggers is valid. The evaluation can also be carried out using logical operator (AND, NAND, OR, NOR, XOR and XNOR)

An **action** is an operation on an output device. This device can be a device of the installation, a device group, another sequence or various other objects (Logic / Boxes / Tools).

The maximum number of allowed sequences is 100.

Click on **new** in the **Sequence** section to create a new sequence.

- rename the sequence directly in the field on the top right.

You can add a description if necessary.

- click **Add a trigger** to start configuring the sequence.
- select a trigger and configure the properties
- click **OK** to save your preferences.
- click **Add a condition** for a more accurate evaluation of the sequence.
- select one or more conditions and configure the properties
- click on **Save** to save your preferences.
- click **Add an Action** to configure the action performed by the trigger.
- select the devices or groups concerned.
- click on **Edit** to set the action to execute
- add other actions if necessary.

 For more information, please see tutorial **12. Configure sequences in domovea** at www.hager.com/domovea.

TJA670 domovea Basic

TJA470 domovea Expert

6.3.2 Home status

Home Status is a general state of the house. It is possible to activate or deactivate sequences according to this status.

Four home status are set by default and can be changed at will (Home - Absence - Night - Holiday). It is also possible to add up to four additional home statuses. The maximum number allowed is 8.

Click on **new** in the **Home status** section to create an additional home status for the project.

- rename the home status directly in the field on the top right.
- choose an icon for your home status.

You can add a description if necessary.

- click **Add a trigger**.
- configure the properties
- click **OK** to save your preferences.
- click on **Add** in the section **Sequences executed at the activation of the home status**.
- select the desired sequence
- add other sequences if necessary.

 For more information, please see tutorial **14. Configure a Home Status in domovea** at www.hager.com/domovea.

TJA670 domovea Basic

TJA470 domovea Expert

6.4 Measures

6.4.1 Measures

The domovea energy display function responds to a growing desire to reduce energy needs. After the data is acquired by the different KNX products, it is transmitted to the domovea server via the KNX TP bus.

The domovea server and software archives this data, which will, after processing, be displayed on a viewing device (tablet, smartphone, PC, etc.)

The maximum number of **Measures** devices permitted is 100.

A **Measures** device can be added:

- Automatically: Using the configuration tool, the system automatically recognises the product. The different devices are thus created.
- Manually: by adding an Energy device (electricity, gas or water)
To create a device, please refer to chapter [6.2.1 Devices](#)

Depending on the type of device, it is possible to assign a subscription.

 For more information, please see tutorial **15 - Configure a Hager Energy Meter with easytool and domovea** at www.hager.com/domovea.

6.4.2 Subscriptions

A subscription defines the cost of power consumptions for a given installation. It is comprised of one or more tariffs, which give the cost according to a given period (day, hour, etc.). The maximum number of permitted subscriptions is 10.

Click on **new** in the **Subscriptions** section to create a new subscription.

- select the type of subscription (electric – water - gas),
- rename the subscription directly in the field on the top right.

You can add a description if necessary.

- select **consumption** or **production** depending on the value of the subscription,
- click on **Use a subscription template** to select a pre-defined subscription.

Or

- click on **Add a tariff** to manually define the type of subscription,
- add other tariffs if required.

 For more information, please see tutorial **16 - Set up energy tariffs to visualize the consumption in domovea** at www.hager.com/domovea.

TJA670 domovea Basic

TJA470 domovea Expert

6.5 Managing user rights

This enables you to define the access rights to the installation for different users. This can vary depending on the case, as shown in the examples below. Example 1: In a family residence, the young son must have access to his bedroom but not the other rooms.

Example 2: In a hotel, it is important that the receptionist is able to manage all of the rooms, but a customer in room “X” must not be able to access, or modify the parameters of, room “Y”. He must not even be able to see them.

Click on **user rights**.

- select the user to manage,
- define the groups, devices and sequences accessible to the user.

To create a user account, please refer to chapter [5.2.2 Users](#)



For more information, please see tutorial **17 - Manage the user rights in domovea** at www.hager.com/domovea.

6.6 Configuration

This is the same as the section on configuration from the project (please refer to chapter [5.2.1 Configuration](#))

TJA670 domovea Basic

TJA470 domovea Expert

7 LIST AND DETAILS OF DEVICES

This section lists all of the peripherals made available to the installation program to create a project.

7.1 KNX devices

7.1.1 Comfort

Devices	Actions	Display
Light	Switch on Switch off Set the brightness to x% Define the colour Set the white temperature (for example 4000°)	On Off Brightness at x% Colour White temperature
Connected socket	Switch on Switch off	On Off
Weather automation	Activate the façade shade x Activate the shade on all façades Deactivate the façade shade x Deactivate the shade on all façades Activate presence Activate absence	Façade shade x activated Shade activated on all façades Façade shade x deactivated Shade deactivated on all façades Heat protection activated Heat recovery activated Presence Absence
Roller shutters	Opening Closing Slats opened Slats closed Shutter in position x% Slats in position x%	Open Close Shutter position x% Slat position x% Position "?" *
Thermostat	Heating mode Cooling mode Comfort mode Eco mode Night mode Protection mode Set the heating setpoint temperature to x°C Set the cooling setpoint temperature to x°C	Current temperature x°C Heating mode Cooling mode Comfort mode Eco mode Night mode Protection mode Setpoint temperature x°C
Virtual Thermostat (Only with TJA470 Domovea Expert)	Open valve Closed valve Valve position in%	Comfort mode Eco mode Night mode Protection mode

* The domovea client application will display a question mark if the KNX product:

- does not have the status indication function of the shutter/store.
- does not respond when the server requests the position of the shutter/store.

TJA670 domovea Basic

TJA470 domovea Expert

Devices	Actions	Display
Overall control of heating	Switch on Switch off	On Off Status of the area x HVAC mode area x Current temperature of area x Load-shedding
Hot water	Variance Forcing	Variance activated Forcing activated
KNX scene	Launch scene x	Scene x launched
Forcing	Activate/deactivate forcing	Forcing activated/deactivated
Audio	Switch on Switch off Reading Pause Set the volume to x% Mute mode Repeat mode Random mode Next source (or playlist) Previous source (or playlist) Next title Previous title	On Off Current playback Pause Volume at x% Mute mode activated Repeat mode activated Random mode activated Current song Current playlist Current artist
Ventilation	Activate/deactivate the ventilation Set the speed level to x% Set turbo mode	Status indication Speed level is x% Turbo mode activated

7.1.2 Access security

Devices	Actions	Display
Alarm area	Arm Disarm	Armed Disarmed Intrusion detection
Alarm box	Arm the entire system Disarm the entire system Arm area x Disarm area x	Entire system armed Entire system disarmed Area x armed Area x disarmed Entrance protected Defect Silent alarm Intrusion Intrusion confirmed Alert Silent alarm Fire alarm Technical alarm

TJA670 domovea Basic

TJA470 domovea Expert

Devices	Actions	Display
Door striker	Open door	Door open

7.1.3 Sensors

Devices	Actions	Display
Temperature	N/A	Temperature at x°C
Wind	N/A	Wind at x km/h
Co2	N/A	CO2 at x ppm
Humidity	N/A	Humidity at x%
Brightness	N/A	Brightness at x lux
Binary input	N/A	On
Rain	N/A	Rain
Smoke detector	N/A	Smoke alarm Heat alarm Room alarm Detector status Local deactivation Manual test Service life Heartbeat
Weather station	N/A	Brightness at x lux Rain External temperature at x° Internal temperature at x° External humidity at x% Wind speed at x km/h

7.1.4 Energy

Devices	Actions	Display
Electricity	N/A	Power Energy Tariff
Gas	N/A	Flow rate Counter
Water	N/A	Flow rate Counter

TJA670 domovea Basic

TJA470 domovea Expert

7.1.5 Generic

Devices	Actions	Display
Generic ON/OFF device	Switch on Switch off	On Off
Command maintained	Switch on Switch off	On Off
Generic pulsed device	Switch on	On
Generic device	Writing of value x on the KNX bus	The value is equal to x

7.1.6 Network

Devices	Actions	Display
URL	Sending an http request	None

7.2 Cameras

This section describes the procedure for creating a link between a network camera and a domovea installation.

Click on **New device** to create a device:

- select **IP Camera** in the **Camera** section,
- click on **Discover cameras** to automatically browse the devices on the network,
- click on the **Add** button,
- change the name of the device if necessary,
- click on **Test** to check the camera image.

A camera can also be installed manually

- click on **Onvif** if your camera is compatible with this protocol,
or
- click **Generic** for all other types,
- change the name of the device if necessary,
- enter the configuration parameters for the connection.

 For more information, please see tutorial **18 - Add cameras in domovea with Hager Pilot** at www.hager.com/domovea.

TJA670 domovea Basic

TJA470 domovea Expert

7.3 IOT devices

domovea is also a monitoring tool for all smart connected devices in the home (IoT).

7.3.1 Philips Hue

This enables you to add a Philips Hue device to the domovea installation.

Click on **New device** to create a device:

- select **Philips Hue** in the **IoT** section,
- click on **Discover Philips Hue** if your lamp does not appear in the list,
- press the Link button on the Hue bridge so that the lamp is detected,
- click on the **Add** button,
- change the name of the device if necessary,
- complete the KNX group addresses if necessary.



i For more information, please see tutorial **19 - Control a Philips Hue lamp or bulb with domovea** at www.hager.com/domovea.

7.3.2 Sonos

This enables you to add a Sonos device to the domovea installation.

Click on **New device** to create a device:

- select **Sonos** in the **IoT** section,
- click on **Discover Sonos speaker** if your speaker does not appear in the list,
- click on the **Add** button,
- change the name of the device if necessary,
- complete the KNX group addresses if necessary.



i For more information, please see tutorial **20 - Control a Sonos speaker with domovea** at www.hager.com/domovea.

7.3.3 Netatmo

This enables you to add a Netatmo weather station to the domovea installation.

Click on **New device** to create a device:

- select **Netatmo** in the **IoT** section,
- Enter the **user name** and **password** for the netatmo account,
- click on the **Add** button,
- change the name of the device if necessary,
- complete the KNX group addresses if necessary.



i For more information, please see tutorial **21 - Add a Netatmo weather station in domovea with Hager Pilot** at www.hager.com/domovea.

7.3.4 Tado

This enables you to add a Tado° connected thermostat to the domovea installation.

Click on **New device** to create a device:

- select **Tado°** in the **IoT** section,
- click on the **Login** button,
- Enter the **user name** and **password** for the Tado° account,



i For more information, please see tutorial **22 - Add a tado° smart thermostat with Hager Pilot** at www.hager.com/domovea.

TJA670 domovea Basic

TJA470 domovea Expert

7.4 Additional connectivity control point

For external devices to control the installation, access must be authorised for different devices.

- click on **Groups** at the top of the screen from the Dashboard.

All of your devices and groups are listed here.

- select a group to activate external access to the domovea installation,
- click on the locks at the top of the screen to activate external access.

Repeat this process for each of the relevant groups

Note: to activate external access for each sub-group, you must open the locks of each sub-group and not just open the one in the group above.

i For more information, please see **23 - Enable external access to skills like Alexa, Google, IFTTT, etc.** at www.hager.com/domovea.

7.4.1 Alexa

This enables you to add the vocal assistant Amazon Alexa to the domovea installation.

Connect to the Amazon Alexa website or to the Alexa application:

- select Skills in the menu,
- install the Hager **domovea** skills,
- enter the user name and password for your Alexa account,
- enter the user name and password of your myHager account,
- follow the instructions until installation is finished.



i For more information, please see tutorial **24 - Control a domovea installation with Alexa vocal assistant** at www.hager.com/domovea.

7.4.2 Google Home

This enables you to add the vocal assistant Google Home to the domovea installation.

Connect to the Google website or to the Google Home application:

- navigate to **Settings**,
- select **More settings** from the bottom of the page,
- select **Home control** in the Assistant tab,
- click **+** and search domovea,
- enter the user name and password of your myHager account,
- follow the instructions until installation is finished.



i For more information, please see tutorial **25 - Control a domovea installation with Google vocal assistant** at www.hager.com/domovea.

7.4.3 IFTTT

This enables you to register the IFTTT service in the installation.

Connect to the IFTTT service website:

- create an account if necessary,
- search domovea in the different applications,
- link your domovea installation to another connected device by following the instructions.



i For more information, please see tutorial **26 - Create an Applet on IFTTT with domovea** at www.hager.com/domovea.

TJA670 domovea Basic

TJA470 domovea Expert

7.5 HEMS

The Home Energy Management System (HEMS) is a combination of hardware and software components that allow the efficient management of a house's energy consumption..

7.5.1 Hager flow

The flow home energy management system manages the flow of electrical energy in a single-family house. The XEM470 energy manager is required as a central control and monitoring unit for flow. It controls additional components such as a battery, one or more electrical charging stations and additional measuring and control devices, which increases the degree of self-sufficiency of the house and to set up an individual plan tailored to particular needs.

domovea allows you to add flow devices to the installation.

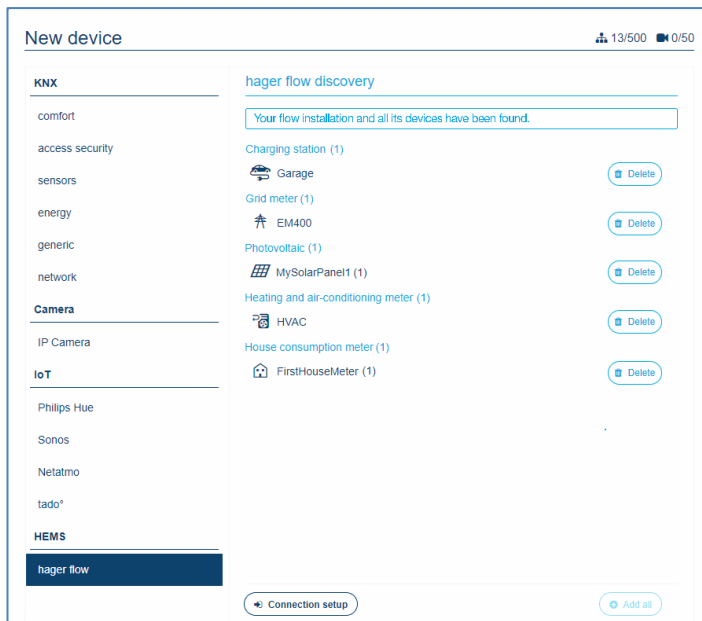

Click on **New device**:

- Select **hager flow** in the **HEMS** section,
- Select the flow devices to be integrated in the domovea application.









- Only up to 3 charging stations , one energy management controller, one energy storage unit and one photovoltaic system can be used per installation. There are no restrictions on consumption meters.
- The used charging stations have to be **Witty solar** type.

TJA670 domovea Basic

TJA470 domovea Expert

List of available devices :

Symbols	Device type	Functions	Value
	Charging station	Car connected	Yes
			No
		Boost available	Yes
			No
		Loading	Yes
			No
		Instant power	Value in Watt
Anomaly	Yes		
	No		
	Energy meter supplier	Instant Power (produced)	Value in Watt
		Instant Power (consumed)	Value in Watt
		Anomaly	Yes
			No
	Photovoltaic	Instant Power	Value in Watt
		Anomaly	Yes
			No
	Heating and cooling meter	Instant Power	Value in Watt
		Anomaly	Yes
			No
		SG ready status	Normal
			On hold
			Boost
Max			
	House consumption meter	Instant Power	Value in Watt
		Anomaly	Yes
			No
	Energy storage	Grid connected	Yes
			No
		State of charge	Value in %
		Instant Power (produced)	Value in Watt
		Instant Power (consumed)	Value in Watt
		Batterie status	Loading
			Unloading
Waiting			

TJA670 domovea Basic

TJA470 domovea Expert

- **Example for optimising energy consumption**

If my battery has a low level of available energy and my solar panels are not producing, my energy consumption should be automatically reduced. This example can be programmed with a **domogram**.

When :

- when my battery has a low level.

If :

- My solar panels do not produce enough energy.

Then :

1. Send a message on the smartphone: "Avoid excessive consumption".
2. Turn off the pool heating.
3. At nightfall: turn off the garden lights.

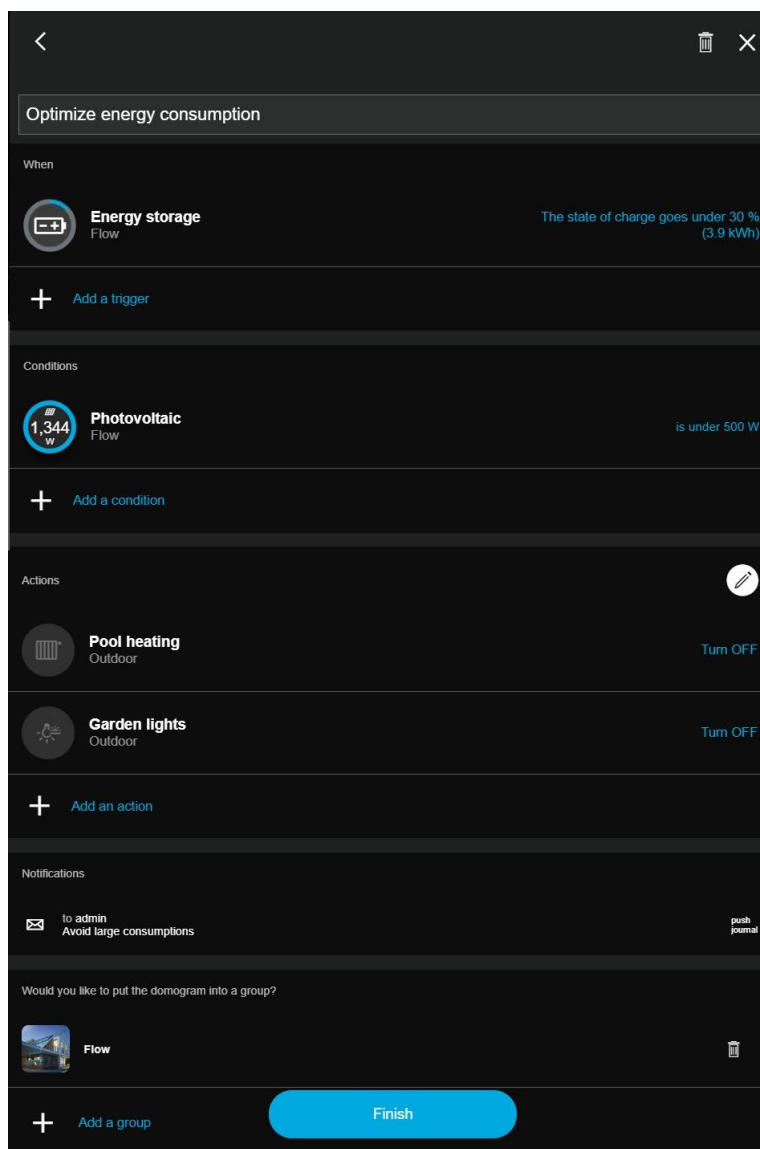

TJA670 domovea Basic

TJA470 domovea Expert

What is SG Ready ?

SG-Ready statuses are based on an algorithm used to optimize the energy used by the heat pumps. These statuses allow to intelligently manage the use of energy according to its price, its availability, the current production and the needs.

The current status of the SG-Ready can be used with the domovea system to optimize the use of energy, especially through sequences.

Signification of the SG Ready status :



ON HOLD : limited energy consumption

NORMAL : Normal operation with low energy consumption

BOOST : Energy available for the comfort mode function

MAX : Maximal availability of energy

