

Technical Product Documentation

Product / Product Range:

Power Switchgear and Controlgear Assemblies in accordance with IEC 61439-2

Rated operational voltage (U_e) 400 V – Rated insulation voltage (U_i) 1,000 V – Rated frequency (f_n) 50 Hz – Rated current of the assembly (I_{nA}) up to 630 A (product segment 1.) / up to 250 A (2./3.) / up to 63 A (4./5.) – Rated conditional short-circuit current (I_{cc}) 25 kA (MCCBs) / 50 kA (fuse links) / 120 kA (NH00 fuse links in product segments 4./5.)

Product Segment:

1. Outdoor Cabinets for univers N
2. Outdoor Pillars for univers N
3. Outdoor Pillars for Switchgear Devices
4. Street Lighting Pillars
5. Metering Cabinets

Manufacturer: Hager Electro GmbH & Co. KG
Zum Gunterstal
66440 Blieskastel
Germany

The results verify the requirements given by the above-mentioned standard.

The results of test reports related to IEC 61439-2 assemblies listed in this documentation are exclusively linked to the tested samples and compared or assessed variants according to the Univers N system and Hager components with indoor conditions. The enclosure as a standalone product is compliant to IEC 62208.

This documentation shall not be reproduced except in full, without written approval.

Pascal Polster
SDM PM Enclosures

Date: 14/08/24 Ver. 1.0

List of Design Verifications

No.	Characteristic to be verified	Clause or sub-clause	Verification by	Applicable document(s)	Verified product / range / series
1	Resistance to corrosion	10.2.2	Test	HPB18040315 HPB20044415 HPB23014215	ZAL...U ZAL...US ZAK...A ZAB... ZAS131... ZAS132...
	Thermal stability	10.2.3.1	Test	VAL230221343	
	Resistance to abnormal heat and fire due to internal electric effects	10.2.3.2	Test	VAL230221343	
	Resistance to ultra-violet (UV) radiation	10.2.4	Test	VAL230221343	
	Lifting	10.2.5	N/A	-	
	Mechanical Impact	10.2.6	Test	VAL230221343	
	Marking	10.2.7	Test	VAL230221343	
2	Degree of protection of enclosures	10.3	Test	VAL230221343	
3	Clearances	10.4	Test	VAL230221343 univers N system	
4	Creepage distances	10.4	Drawing	VAL230221343 univers N system	
5	Effective continuity between the exposed conductive parts of the assembly and the protective circuit	10.5.2	N/A	-	

	Short-circuit withstand strength of the protective circuit	10.5.3	Test	VAL230221343 univers N system	
6	Incorporation of switching devices and components	10.6	Manufacturer	VAL230221343 univers N system up to 630 A and devices accordingly (with exceptions, see MCCB list)	
7	Internal electrical circuits and connections	10.7	Manufacturer	VAL230221343 Manufacturer Documentation	
8	Terminals for external conductors	10.8	Manufacturer	VAL230221343 Manufacturer Documentation	
9	Power frequency withstand voltage	10.9.2	Test	VAL230221343 univers N system	
	Impulse withstand voltage	10.9.3	Test	VAL230221343 univers N system	
10	Temperature-rise limits	10.10	Test	VAL230221343	
11	Short-circuit withstand strength	10.11	Test	VAL230221343	
12	Electromagnetic compatibility (EMC)	10.12	N/A	-	
13	Mechanical operation	10.13	Test	VAL230221343	

10.2 Strength of materials and parts

10.2.2 Resistance to corrosion

The ferrous metallic constructional parts of the listed assemblies were subjected to the damp heat cycling test of IEC 60028-2-30: Severity A – Temperature 55 °C, 6 cycles and variant 1. After the test, no unacceptable deteriorations were observed, in compliance with ISO 628-3:2016.

10.2.3 Properties of insulating materials

10.2.3.1 Thermal stability

The listed enclosures were tested in accordance with IEC 60068-2-2:2007, Test Bb, at a temperature of 70 °C, with natural air circulation, for a duration of 168 h and a recovery of 96 h. There appeared no cracks or other deteriorations on the housing surface.

10.2.3.2 Resistance of insulating materials to abnormal heat and fire due to internal electric effects

All insulating materials used in the listed references were subjected to the glow-wire test according to IEC 60695-2-10/-11. All requirements were fulfilled. The temperature of the glow-wire tip was

- 960 °C for parts necessary to retain current-carrying parts in position (housing material)
- 650 °C for all other parts, including parts necessary to retain the protective conductor

10.2.4 Resistance to ultraviolet (UV) radiation

Specimens of the housing material of the listed enclosures were UV tested in accordance with ISO 4892-2:2013, method A, cycle 1 for an overall duration of 500 h. The samples fulfilled the requirements and retained their values of flexural strength (ISO 178) and Charpy impact (ISO 179) for at least 70 %.

Test Criterion	Unit	Target	Value
before weathering			
Impact strength	KJ/m ²	--	47
Flexural modulus of elasticity	MPa	--	10,400
Flexural strength	MPa	--	136
Elongation at flexural strength	%	--	2.2
after weathering			
Impact strength	KJ/m ²	≥ 33	45
Flexural modulus of elasticity	MPa	≥ 7,280	10,000
Flexural strength	MPa	≥ 95	129
Elongation at flexural strength	%	≥ 1.5	2.2

10.2.5 Lifting

This clause is not applicable to the product range since there are no lifting devices for the enclosures.

10.2.6 Mechanical Impact

The verification of the protection degree against mechanical impacts (IK code) was carried out in accordance with IEC 62262. While the enclosure was fixed as in the normal use case, all exposed surfaces whose largest dimensions are less than or equal to 1 m were hit three times with the described hammer applying an impact energy of 20 J (IK10). All other surfaces whose largest dimensions exceed 1 m were hit 5 times accordingly. The impacts were evenly distributed over the face of the enclosure. The specimens passed since the degree of protection (IP code) was not impaired after the test. The dielectric properties maintained and the function of the doors and covers was not impacted.

10.2.7 Marking

The wipe test was done in sequence with water and a solvent, and the marking was still legible afterwards.

10.3 Degree of protection

The listed enclosures were inspected in accordance with IEC 60529:1989, IEC 60529:1989/AMD1:1999, and IEC 60529:1989/AMD2:2013. The value IPX4 is fulfilled by all assemblies since no water can enter the protected area inside the cabinets. The value IP4X is also fulfilled by all enclosures, except for the aeration area of the KVS range indicated in the respective sections (product segments 1. & 5.) Here, we have a reduction to IP3XD between roof and back wall and between the door edges and the side walls (for details, see page 10).

10.4 Clearances and creepage distances

The clearances and creepage distances are in accordance with the requirements (electrical clearances ≥ 8 mm, creepage distances ≥ 11 mm).

10.5 Protection against electric shock and integrity of protective circuits

10.5.2 Effective earth continuity between the exposed-conductive-parts of the class I assembly and the protective circuit

This test is not applicable to this product range.

10.5.3 Short-circuit withstand strength of the protective circuit

The short-circuit tests were performed and the results can be seen on page 7, clause 10.11.

10.6 Incorporation of switching devices and components

These enclosures are designed to incorporate the internal distribution system univers N and the corresponding devices (Product segments 1., 2. & 4.). Product segment 3. is designed for vertical fusegear devices, and product segment 5. for internal distribution system univers Z and devices. All devices must be tested in accordance with their respective product standard. The assembly manufacturer is responsible for the selection of the equipment and design of the assembly according to the requirements of the application and the installation site. Especially the outdoor use with its special environmental conditions needs to be assessed and the performance parameters have to be provided by the assembly manufacturer. This document does not describe the climate condition limits of the switching devices and other components used for the final assembly.

All original manufacturer tests performed with Hager devices have been executed with climate conditions for the indoor use according to the univers indoor applications compliant to IEC 61439-2.

10.7 Internal electrical circuits and connections

The products are designed to fulfill the requirements of section 8.6 of IEC 61439-1:2020.

10.8 Terminals for external conductors

The applicable requirements of cl. 8.8 are fulfilled. Further details are listed in annex A of IEC 61439-1:2020 and the respective product sections.

10.9 Dielectric properties

10.9.2 Power-frequency withstand voltage

All test specimens were subjected to the test voltage of 2,200 V (from table 8, IEC 61439-1:2020, $U_i \leq 1.000$ V) for a duration of 60 s

a) between all live parts of the connected main circuit (including the auxiliary circuits connected to the main circuit) and exposed-conductive-parts, with the main contacts of all switching devices in the closed position or bridged by a suitable low resistance link.

b) between each live part of different potential of the main circuit and, the other live parts of different potential and exposed-conductive-parts connected, with the main contacts of all switching devices in the closed position or bridged by a suitable low resistance link.

During the test, there was no detectable current flow and no disruptive discharge.

10.9.3 Impulse withstand voltage

All specimens were subjected to a test voltage of 9.6 kV (400 VAC application) (from table 10, IEC 61439-1:2020, $U_{imp} = 8$ kV)

a) between all the live parts of different potential of the main circuit connected together (including the auxiliary circuits connected to the main circuit) and exposed-conductive parts, with the main contacts of all switching devices in the closed position or bridged by a suitable low-resistance link.

b) between each live part of different potential of the main circuit and the other live parts of different potential and exposed-conductive-parts connected, with the main contacts of all switching devices in the closed position or bridged by a suitable low resistance link.

10.9.4 Testing of enclosures made of insulating material

An insulation test was performed where an AC test voltage of 1.5 times of the above-mentioned value (3,300 V) was applied between a metal foil laid on outer surface of the enclosure over openings and joints, and the interconnected live and exposure-conductive parts within the assembly located next to the openings and joints.

During the test, there was no current and no disruptive discharge.

10.9.5 External door or cover mounted operating handles of insulating material

In analogy, an insulation test was performed for the door handles of the enclosures where the voltage was applied between the active parts and a metal foil completely enfolding the housing.

During the test, there was no current and no disruptive discharge.

10.10. Temperature-rise limits

See the respective sections in the product segments.

10.11 Short-circuit withstand

The test was performed as described in IEC 61439-1:2020, clause 10.11.5. The test specimens represent the most critical enclosures in the most critical configuration in accordance with table 13.

KVS enclosures (product segments 1. & 5.)

Tested devices and respective rated conditional short-circuit current I_{CC} values.

Devices	Verified I_{CC}
MCCBs (see exception matrix on page 20) --> only for product segment 1. HNS160JC HNT250JR HHA160H HNB250H	25 kA
Devices with fuse links --> only for product segment 1. Devices with fuse links up to 63 A gG	50 kA
MCBs --> <i>product segment 5. only for devices up to 25 kA</i>	up to 50 kA
Fuse switch disconnectors --> only for product segment 1. Devices with fuse links up to 630 A gG	50 kA

ZAS enclosures (product segments 2., 3. & 4.)

Tested devices and respective rated conditional short-circuit current I_{CC} values.

Devices	Verified I_{CC}
Devices with fuse links --> only for product segment 2. Devices with fuse links up to 63 A gG	50 kA
MCBs --> <i>only for product segment 2. & 4. / product segment 4. only for devices up to 25 kA</i>	up to 50 kA
Fuse switch disconnectors --> only for product segment 2. & 3. Devices with fuse links up to 400 A gG	40 kA

10.12 Electromagnetic compatibility (EMC)

The assemblies are designed in accordance with IEC 61439-1:2020, Annex J.9.4.2, and fulfill the following conditions:

- a) the incorporated devices and components are in compliance with the requirements for EMC for the stated environment (see J.9.4.1) as required by the relevant product or generic EMC standard.
- b) the internal installation and wiring is carried out in accordance with the devices and components' manufacturer's instructions (arrangement with regard to mutual influences, cable, screening, earthing, etc.).

A dedicated verification as described in J.10.12 is not necessary. The documentation of the devices' manufacturers must be considered.

10.13 Mechanical operation

After 200 mechanical cycles of the closing mechanism and the door, the protection degree of the enclosure was not affected. The force necessary for using the door did not change after the test.

General Aspects for KVS Cabinets

General characteristics

Technical Characteristic	Technical Value
Dimensional Standard	DIN 43629-1/-2/-3
Product Standards	IEC 61439-1:2020-05, EN 61439-1:2011 IEC 61439-2:2020-07, EN 61439-2:2011
Classification according to IEC 62208	
Type of Material	Insulating
Method of Fixing	Floor standing (on-ground / in-ground) / wall mounting (wall console)
Intended Location	Outdoor
Degree of Protection (IP)	general: IP44 (IEC 60529) ventilation areas: IP34D (IEC 60529)
Protection against Mechanical Impact (IK)	IK10 (IEC 62262)
Rated Insulation Voltage U_i	1,000 V AC
Enclosure Material	
Material Type	Glass-fibre reinforced polyester (EN 14598-1 UP)
Colour	RAL 7035
Material Conformity	Low-Voltage Directive 2014/35/EU RoHS Directive 2011/65/EU + RoHS 2015/863/EU (Amendment) REACH Regulation EC 1907/2006
General Characteristics	
Surface Structure	Ribbed
Surface Treatment	Untreated
Protection Class	II
Permissible Loads	See chapter <i>Permissible Loads</i>
Environmental Conditions	
Ambient temperature min./max./24 h average	-25 °C / 40 °C / 35 °C Working temperatures for devices must be considered.
Maximum relative humidity	100 % at -25 °C to +27 °C 60% at 35 °C 46% at 40 °C
Pollution Degree	3
Electrical Characteristics	
Volume Resistivity	10^{14} Ohm*cm (IEC 60093)
Dielectric Strength	4 kV (EN 60598-1) 14.5 kV (IEC 61439-1:2020)
Tracking Resistance	CTI 600 (IEC 60112)
Thermal Characteristics	
Glow-wire test	960 °C (IEC 60698-2-1)
Flammability	V0 4.0 mm (UL-94)

Heat Resistance	> 140 °C (IEC 62208/ IEC 60216) > 200 °C (ISO 75-2 A)
Chemical Characteristics	
Halogen content	Halogen free
Resistance against termites	Termite resistant
UV and Corrosion Resistance	
UV resistance, mechanical	> 70 % retaining values of flexural strength (ISO 178) and Charpy impact (ISO 179)
Corrosion Resistance of Metal Parts	Damp heat cycling test (IEC 60028-2-30), Severity A, 55 °C, 6 cycles and variant 1
Further Requirements according to IEC 62208	
Axial Loads of Metal Inserts	Not applicable
Thermal Stability (9.9.1)	Dry heat IEC 60068-2-2 Test Bb / 70 °C
Resistance to Normal Heat (9.9.2)	IEC 60085
Resistance to Abnormal Heat and to Fire (9.9.3)	960 °C IEC 60695-2-10 / -11
Dielectric Strength (9.10)	1.5 times 2,200 VAC

Exceptions of IP Protection

The cabinets have an IP protection of IP44 in accordance with IEC 60529 except in the defined ventilation areas shown below. In these areas, the protection is reduced to IP34D. This means, that still no water can reach the protected space since the second numeral of the code remains identical. The first numeral is reduced to 3 with the addition of the letter "D" at the end. This means, 1 mm wire cannot enter the cabinet and reach the protected space or any live parts, but a spherical object that can run through the ventilation labyrinth might enter the enclosure.

Left: Ventilation area between back wall and roof; right: ventilation area at the edges of back wall and door to the side wall

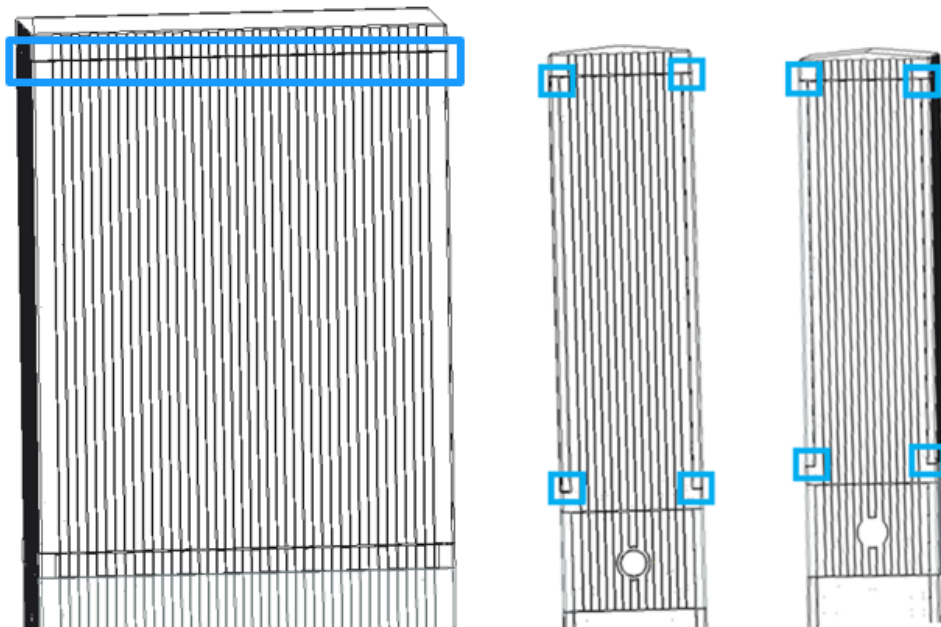

General Aspects for ZAS Pillars

General characteristics

Technical Characteristic	Technical Value
Product Standards	IEC 61439-1:2020-05 EN 61439-1:2011 IEC 61439-2:2020-07, EN 61439-2:2011
Classification according to IEC 62208	
Type of Material	Insulating
Method of Fixing	Floor standing (in-ground)
Intended Location	Outdoor
Degree of Protection (IP)	IP44 (IEC 60529)
Protection against Mechanical Impact (IK)	IK10 (IEC 62262)
Rated Insulation Voltage U_i	1,000 V AC
Enclosure Material	
Material Type	Glass-fibre reinforced polyester (EN 14598-1 UP)
Colour	RAL 7035
Material Conformity	Low-Voltage Directive 2014/35/EU RoHS Directive 2011/65/EU + RoHS 2015/863/EU (Amendment) REACH Regulation EC 1907/2006
General Characteristics	
Surface Structure	Ribbed
Surface Treatment	Untreated
Protection Class	II
Permissible Loads	See chapter <i>Permissible Loads</i>
Environmental Conditions	
Ambient temperature min./max./24 h average	-25 °C / 40 °C / 35 °C Working temperatures for devices must be considered.
Maximum relative humidity	100 % at -25 °C to +27 °C 60% at 35 °C 46% at 40 °C
Pollution Degree	3
Electrical Characteristics	
Volume Resistivity	10 ¹⁴ Ohm cm (IEC 60093)
Dielectric Strength	4 kV (EN 60598-1) 14.5 kV (IEC 61439-1:2020)
Tracking Resistance	CTI 600 (IEC 60112)
Thermal Characteristics	
Glow-wire test	960 °C (IEC 60698-2-1)
Flammability	V0 4.0 mm (UL-94)
Heat Resistance	> 140 °C (IEC 62208/ IEC 60216) > 200 °C (ISO 75-2 A)
Chemical Characteristics	

Halogen content	Halogen free
Resistance against termites	Termite resistant
UV and Corrosion Resistance	
UV resistance, mechanical	> 70 % retaining values of flexural strength (ISO 178) and Charpy impact (ISO 179)
Corrosion Resistance of Metal Parts	Damp heat cycling test (IEC 60028-2-30), Severity A, 55 °C, 6 cycles and variant 1
Further Requirements according to IEC 62208	
Axial Loads of Metal Inserts	Compliant to section 9.6
Thermal Stability (9.9.1)	Dry heat IEC 60068-2-2 Test Bb / 70 °C
Resistance to Normal Heat (9.9.2)	IEC 60085
Resistance to Abnormal Heat and to Fire (9.9.3)	960 °C IEC 60695-2-10 / -11
Dielectric Strength (9.10)	1.5 times 2,200 VAC

1. Outdoor Cabinets for univers N

ZAL...U



Overview of series univerts N Enclosures Outdoor (ZAL...U)

Cable Distribution Cabinets KVS (CDC)		
Size	1	2
Width in mm	780	1110
Height in mm	Depth: 315 mm	
1005		
Empty enclosure for univerts N:	ZAL53U	ZAL64U
1355		
Empty enclosure for univerts N:	ZAL83U	ZAL84U
Necessary Amount of ZAY95075:	3 bags	4 bags

Reference table outdoor enclosures for univerts N (ZAL...U)

Reference	Description
ZAL53U	CDC, size 1/1005, for univerts N system
ZAL64U	CDC, size 2/1005, for univerts N system
ZAL83U	CDC, size 1/1355, for univerts N system
ZAL84U	CDC, size 2/1355, for univerts N system

Measurements in accordance with DIN 43629-1

Pedestals

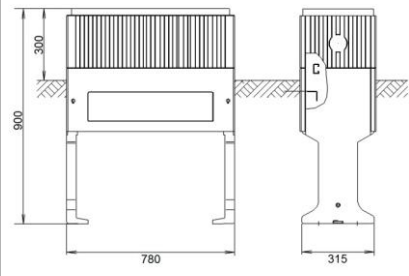
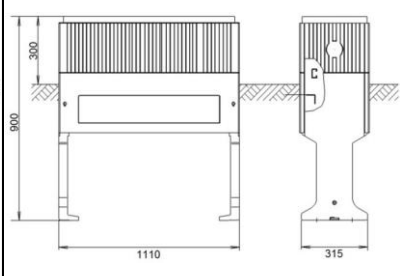
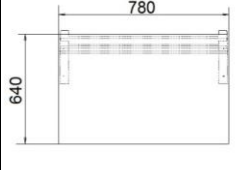
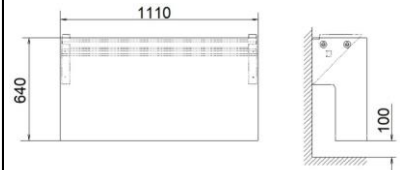
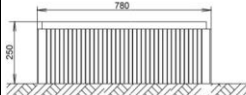
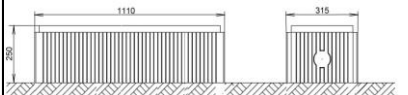
Cable Distribution Cabinets KVS (CDC)		
Size	1	2
Width in mm	780	1110
Necessary Amount of ZAY95075:	3 bags	4 bags
Pedestal ZAX - Standard		
900		
	ZAX006	ZAX007
Pedestal ZAX - Wall Console		
640		
	ZAX012	ZAX013
Pedestal ZAX - On-ground pedestal		
250		
	ZAX015	ZAX016

Reference table Pedestals for Cable Distribution Cabinets

Reference	Description
ZAX006	Embedded pedestal, size 1, height: 900 mm
ZAX007	Embedded pedestal, size 2, height: 900 mm
ZAX012	Wall console, size 1, height: 640 mm
ZAX013	Wall console, size 2, height: 640 mm
ZAX015	Surface-mounted base, size 1, height: 250 mm
ZAX016	Surface-mounted base, size 2, height: 250 mm

Measurements in accordance with DIN 43629-2

Interface characteristics

In respect to IEC 61439-1:2020 & IEC 61439-2:2020

Characteristic	Value
Voltage Ratings	
Rated voltage U_n	400 V
Rated operational voltage U_e	400 V
Rated insulation voltage U_i	1,000 V
Rated impulse withstand voltage U_{imp}	up to 8 kV (consider the values of the devices)
Current Ratings	
Rated current of the assembly I_{nA}	up to 630 A → consider the necessary verification of temperature-rise
Rated conditional short-circuit current of an ASSEMBLY I_{cc}	25 kA (MCCBs) / up to 50 kA (MCBs) / 50 kA (fuse links)
Rated diversity factor RDF	none
Rated frequency f_n	50 Hz

Other characteristics

In respect to IEC 61439-1:2020 & IEC 61439-2:2020

a) additional requirements depending on the use of a functional unit (e.g. type of coordination, overload characteristics)

None

b) pollution degree of the macro-environment (see 3.6.10.2)

III

c) types of earthing system for which the assembly is designed

TN, TT

d) indoor and/or outdoor installation (see 3.5.1 and 3.5.2)

Outdoor installation

The use of switching devices and other components needs to be assessed and confirmed according to the intended climate conditions by the assembly manufacturer.

e) stationary or movable (see 3.5.3 and 3.5.4)

Stationary

f) degree of protection against contact with hazardous live parts, ingress of solid foreign bodies and water, IP code (See 8.2.2 of IEC 61439-1:2020)

IP44, except defined ventilation area: **IP34D**

g) intended for use by electrically skilled, competent or instructed persons (see 3.7.13, 3.7.14 and 3.7.15 of IEC 61439-1:2020)

Skilled persons

h) electromagnetic compatibility (EMC) classification (see Annex J)

i) special service conditions, if applicable (see 7.2)

no special service conditions

j) external design (see 3.3)

enclosed assembly (IP44/IP34D)

k) degree of protection against mechanical impact, IK code, if applicable (see 8.2.1)

IK10

l) type of construction – fixed, removable or withdrawable parts (see 8.5.1 of IEC 61439-1:2020 and 8.5.2)

Fixed parts

m) type of short-circuit protective device(s) (see 9.3.2)

MCCBs, vertical switchgear devices, circuit breakers, etc.

n) measures for protection against electric shock

Protection class II

o) overall dimensions (including projections e.g handles, covers, doors), if required

Not required

p) weight, if required

Not required

q) installation method

in-ground pedestal, on-ground pedestal, wall console (see overview for ZAL...U)

r) external conductor type (see 8.8)

cable

s) direction of external conductors (see 8.8)

from below

t) external phase conductor, cross sections and terminations (see 8.8)

according to Annex A, termination depending on setup, mostly on clamps / terminals

u) external PEN conductor, cross sections and terminations (see 8.8)

according to table 5, IEC 61439-1, termination depending on setup, mostly on clamps / terminals

aa) form of internal separation and associated degree of protection(s), IP code (see 8.101)

back side: mounting plate; side: univers N vertical separator parts (polystyrene);

top and bottom: univers N Stirnteile (polyamide); front: univers N front covers closed or slotted (polystyrene); IP code with open door: IP3X

bb) types of electrical connections of functional units (see 8.5.101)

cables and terminals

cc) mounting orientation (horizontal, vertical, etc.) if the assembly can be mounted in different positions from vertical

devices can be mounted horizontally or vertically depending on the univers N installation kit

Thermal Power Dissipation

The overview of these values are shown in the table below, indicating the maximum power dissipation capability of the cabinet at a temperature increase of $\Delta T = 35 \text{ K}$ at an ambient temperature of $35 \text{ }^\circ\text{C}$, with the maximum temperature at 100 % cabinet height. This is therefore the worst-case value for the assembly.

Reference	Outer dimensions H x W x D / mm	$P_{\max} /$ W	Weight / kg
ZAL53U	1,005 x 780 x 315	254	34
ZAL83U	1,355 x 780 x 315	375	45
ZAL64U	1,005 x 1,110 x 315	328	52
ZAL84U	1,355 x 1,110 x 315	450	65

The verification of temperature-rise according to IEC 61439-1 can be achieved via calculation as described in sub-clause 10.10.4.2 in that standard. When designing the assembly, the temperature-rise limits must be respected. It falls to the assembly manufacturer to fulfil this verification when designing the assembly.

The general requirements described in sub-clause 10.10.4.1 must be fulfilled for the calculation to be valid. If this is the case, the following values are representative for the maximum power dissipation capability of the cabinets. Thus, the sum of all power dissipation values of all installed electrical equipment like cables, devices, meters, etc. must be smaller than the values below in the tables below. The installation situation, ambient temperature and the installed device with the lowest maximum operating temperature determine which value must be considered for the assembly.

Example: The device in the assembly with the lowest maximum operating temperature might be a residual-current circuit breaker (RCCB) which might have a maximum operating temperature of 55°C . It might be placed at 75% of the height of the cabinet. The cabinet might be placed free standing at a location with an ambient temperature of 35°C . This would mean for a cabinet ZAL53U that the maximum ΔT would be 20 K. At 75 % cabinet height in a free standing assembly, the maximum admissible power dissipation would therefore be 152 W. The sum of the power losses of all installed electrical components would need to be below 152 W for the assembly to respect the temperature rise limits.

Following, the tables show the calculated values for all cabinets in accordance with IEC 60890.

Key:

Location of temperature reference point:

t1,0: at 100 % height of the cabinet

t0,75: at 75% height of the cabinet

t0,5: at 50 % height of the cabinet

Type of installation:

FR: free standing enclosure

AP: wall mounting enclosure

ZAL53U

ΔT	t1,0		t0,75		t0,5	
	FR	AP	FR	AP	FR	AP
+5K	22 W	19 W	27 W	23 W	33 W	28 W
+10K	53 W	46 W	64 W	54 W	79 W	66 W
+15K	88 W	76 W	106 W	90 W	131 W	109 W
+20K	126 W	109 W	152 W	129 W	188 W	157 W
+25K	167 W	144 W	200 W	170 W	248 W	207 W
+30K	209 W	181 W	251 W	214 W	311 W	260 W
+35K	254 W	219 W	304 W	259 W	377 W	315 W

ZAL83U

ΔT	t1,0		t0,75		t0,5	
	FR	AP	FR	AP	FR	AP
+5K	29 W	24 W	36 W	30 W	46 W	38 W
+10K	69 W	59 W	85 W	72 W	109 W	90 W
+15K	114 W	98 W	141 W	119 W	181 W	150 W
+20K	163 W	140 W	201 W	170 W	259 W	215 W
+25K	216 W	184 W	266 W	225 W	343 W	284 W
+30K	271 W	232 W	334 W	282 W	430 W	356 W
+35K	328 W	281 W	405 W	342 W	521 W	431 W

ZAL64U

ΔT	t1,0		t0,75		t0,5	
	FR	AP	FR	AP	FR	AP
+5K	33 W	28 W	39 W	32 W	47 W	38 W
+10K	79 W	67 W	93 W	78 W	112 W	92 W
+15K	130 W	111 W	154 W	129 W	185 W	152 W
+20K	187 W	159 W	220 W	184 W	265 W	218 W
+25K	247 W	210 W	290 W	243 W	350 W	288 W
+30K	310 W	264 W	364 W	305 W	439 W	361 W
+35K	375 W	319 W	441 W	370 W	532 W	437 W

ZAL84U

ΔT	t1,0		t0,75		t0,5	
	FR	AP	FR	AP	FR	AP
+5K	40 W	36 W	48 W	43 W	59 W	52 W
+10K	94 W	86 W	114 W	102 W	141 W	124 W
+15K	157 W	143 W	188 W	169 W	234 W	206 W
+20K	224 W	204 W	269 W	242 W	335 W	295 W
+25K	296 W	270 W	356 W	320 W	442 W	389 W
+30K	371 W	338 W	447 W	401 W	555 W	489 W
+35K	450 W	410 W	541 W	486 W	672 W	592 W

Permissible Loads



The overview of these values are shown in the table below.

Hager reference	Outer dimensions H x W x D / mm	Permissible loads / kg	
		Cabinet	Door(s)
ZAL53U	1,005 x 780 x 315	50	1
ZAL83U	1,355 x 780 x 315	50	1
ZAL64U	1,005 x 1,110 x 315	50	1
ZAL84U	1,355 x 1,110 x 315	50	1

Application Matrix MCCBs

The MCCBs of the hager range H3+ were tested in combination with the cabinets concerning the short-circuit withstand strength of the assembly. The following application matrix shows which device can be used in which cabinet.

According IEC 61439-2:2020-07





P1
160 A

Depth: 315 mm

Product Range: Outdoor 160A MCCB

Height / mm	single door	double door
1.350	ZAL83U 25kA	ZAL84U 25kA
1.080	ZAL53U 25kA	ZAL64U 25kA
	780	1.115
		Width / mm

P2
250 A

Depth: 315 mm

Product Range: Outdoor 250A MCCB

Height / mm	single door	double door
1.350	ZAL83U 10kA	ZAL84U 25kA
1.080	ZAL53U 10kA	ZAL64U 25kA
	780	1.115
		Width / mm

Legend

dark-green	tested with the specified lcc current and test report
light-green	derivated from tested version to the specified current
grey	exempt up to lcc=10kA

General Remarks

The built-in switching devices and components have to be chosen considering the requirements of outdoor application (e.g. concerning humidity and temperature conditions). Consultation of the manufacturer's technical documentation is mandatory. Should it be impossible to guarantee the ambient temperature limits defined in IEC 61439-1, it is imperative that the assembly manufacturer ensures the operating conditions for the switchgear assembly. Possible actions include, but are not limited to, installation in the shade, the use of a protective plate above the enclosure, the correct configuration of the switching devices concerning thermal tripping characteristics. Additionally, the rated diversity factor has to be considered. The same applies for extra low temperatures and high humidity. In any case, the assembly manufacturer must consider the climate conditions and needs to specify according to the desired use of the specific assembly.

2. Outdoor Pillars for univers N

ZAL...US



Overview of series univerts N enclosures outdoor (ZAL...US)

Univerts N Enclosures (ZAL...US)		
Size	5	7
Width in mm	583	839
Height in mm		
1710		
Empty enclosure for univerts N:	ZAL52US	ZAL53US
2010		
Empty enclosure for univerts N:	ZAL72US	ZAL73US
Necessary Amount of ZAY95075:	2 bags	3 bags

Reference table outdoor enclosures for univerts N (ZAL...US)

Reference	Description
ZAL52US	Distribution Pillar, for univertsN, with base, 1710 x 583 x 277 mm
ZAL53US	Distribution Pillar, for univertsN, with base, 1710 x 839 x 277 mm
ZAL72US	Distribution Pillar, for univertsN, with base, 2010 x 583 x 277 mm
ZAL73US	Distribution Pillar, for univertsN, with base, 2010 x 839 x 277 mm

Interface characteristics

In respect to IEC 61439-1:2020 & IEC 61439-2:2020

Characteristic	Value
Voltage Ratings	
Rated voltage U_n	400 V
Rated operational voltage U_e	400 V
Rated insulation voltage U_i	1,000 V
Rated impulse withstand voltage U_{imp}	up to 8 kV (consider the values of the devices)
Current Ratings	
Rated current of the assembly I_{nA}	up to 250 A → consider the necessary verification of temperature-rise
Rated conditional short-circuit current of an ASSEMBLY I_{cc}	50 kA (fuse links) / up to 100 kA (MCBs) use of MCCBs not allowed
Rated diversity factor RDF	none
Rated frequency f_n	50 Hz

Other characteristics

In respect to IEC 61439-1:2020 & IEC 61439-2:2020

a) additional requirements depending on the use of a functional unit (e.g. type of coordination, overload characteristics)

None

b) pollution degree of the macro-environment (see 3.6.10.2)

III

c) types of earthing system for which the assembly is designed

TN, TT

d) indoor and/or outdoor installation (see 3.5.1 and 3.5.2)

Outdoor installation

The use of switching devices and other components need to be assessed and confirmed according to the intended climate conditions by the assembly manufacturer.

e) stationary or movable (see 3.5.3 and 3.5.4)

Stationary

f) degree of protection against contact with hazardous live parts, ingress of solid foreign bodies and water, IP code (See 8.2.2 of IEC 61439-1:2020)

IP44

g) intended for use by electrically skilled, competent or instructed persons (see 3.7.13, 3.7.14 and 3.7.15 of IEC 61439-1:2020)

Skilled persons

h) electromagnetic compatibility (EMC) classification (see Annex J)

i) special service conditions, if applicable (see 7.2)

no special service conditions

j) external design (see 3.3)

enclosed assembly (IP44)

k) degree of protection against mechanical impact, IK code, if applicable (see 8.2.1)

IK10

l) type of construction – fixed, removable or withdrawable parts (see 8.5.1 of IEC 61439-1:2020 and 8.5.2)

Fixed parts

m) type of short-circuit protective device(s) (see 9.3.2)

Vertical switchgear devices, circuit breakers, etc. (Use of MCCBs is not allowed in ZAS enclosures)

n) measures for protection against electric shock

Protection class II

o) overall dimensions (including projections e.g handles, covers, doors), if required

Not required

p) the weight, if required

Not required

q) installation method

in-ground mounting

r) external conductor type (see 8.8)

cable

s) direction of external conductors (see 8.8)

from below

t) external phase conductor, cross sections and terminations (see 8.8)

according to Annex A, termination depending on setup, mostly on clamps / terminals

u) external PEN conductor, cross sections and terminations (see 8.8)

according to table 5, IEC 61439-1, termination depending on setup mostly on clamps / terminals

aa) form of internal separation and associated degree of protection(s), IP code

back side: back wall; side: univers N vertical separator parts (polystyrene);

top and bottom: univers N Stirnteile (polyamide); front: univers N front covers closed or slotted (polystyrene); IP code with open door: IP3X

bb) types of electrical connections of functional units

cables and terminals

cc) mounting orientation (horizontal, vertical, etc.) if the assembly can be mounted in different positions from vertical

devices can be mounted horizontally or vertically depending on the univers N installation kit

Thermal Power Dissipation

The overview of these values are shown in the table below, indicating the maximum power dissipation capability of the cabinet at a temperature increase of $\Delta T = 35$ K at an ambient temperature of 35 °C, with the maximum temperature at 100 % cabinet height. This is therefore the worst-case value for the assembly.

Reference	Outer dimensions H x W x D / mm	P _{max} / W	Weight / kg
ZAL52US	1,710 x 583 x 277	185	30
ZAL53US	1,710 x 838.5 x 277	277	36
ZAL72US	2,010 x 583 x 277	229	32
ZAL73US	2,010 x 838.5 x 277	341	44

The verification of temperature-rise according to IEC 61439-1 can be achieved via calculation as described in sub-clause 10.10.4.2 in that standard. When designing the assembly, the temperature-rise limits must be respected. It falls to the assembly manufacturer to fulfil this verification when designing the assembly.

The general requirements described in sub-clause 10.10.4.1 must be fulfilled for the calculation to be valid. If this is the case, the following values are representative for the maximum power dissipation capability of the cabinets. Thus, the sum of all power dissipation values of all installed electrical equipment like cables, devices, meters, etc. must be smaller than the values below in the tables below. The installation situation, ambient temperature and the installed device with the lowest maximum operating temperature determine which value must be considered for the assembly.

Example: The device in the assembly with the lowest maximum operating temperature might be a residual-current circuit breaker (RCCB) which might have a maximum operating temperature of 55°C. It might be placed at 75% of the height of the cabinet. The cabinet might be placed free standing at a location with an ambient temperature of 35°C. This would mean for a cabinet ZAL52US that the maximum ΔT would be 20 K. At 75 % cabinet height in a free standing assembly, the maximum admissible power dissipation would therefore be 115 W. The sum of the power losses of all installed electrical components would need to be below 115 W for the assembly to respect the temperature rise limits.

Following, the tables show the calculated values for all cabinets in accordance with IEC 60890.

Key:

Location of temperature reference point:

t1,0: at 100 % height of the cabinet

t0,75: at 75% height of the cabinet

t0,5: at 50 % height of the cabinet

Type of installation:

FR: free standing enclosure

AP: wall mounting enclosure

ZAL52US

ΔT	t1,0	t0,75	t0,5
	FR	FR	FR
+5K	16 W	20 W	26 W
+10K	39 W	48 W	63 W
+15K	64 W	80 W	105 W
+20K	92 W	115 W	150 W
+25K	122 W	152 W	198 W
+30K	153 W	190 W	249 W
+35K	185 W	231 W	302 W

ZAL53US

ΔT	t1,0	t0,75	t0,5
	FR	FR	FR
+5K	24 W	29 W	37 W
+10K	58 W	71 W	89 W
+15K	96 W	117 W	147 W
+20K	138 W	168 W	211 W
+25K	182 W	221 W	279 W
+30K	229 W	278 W	350 W
+35K	277 W	337 W	424 W

ZAL72US

ΔT	t1,0	t0,75	t0,5
	FR	FR	FR
+5K	20 W	25 W	35 W
+10K	48 W	61 W	83 W
+15K	79 W	101 W	137 W
+20K	114 W	145 W	196 W
+25K	150 W	192 W	259 W
+30K	189 W	240 W	325 W
+35K	229 W	291 W	394 W

ZAL73US

ΔT	t1,0	t0,75	t0,5
	FR	FR	FR
+5K	30 W	37 W	49 W
+10K	71 W	89 W	116 W
+15K	118 W	147 W	192 W
+20K	170 W	211 W	275 W
+25K	224 W	279 W	363 W
+30K	281 W	350 W	455 W
+35K	341 W	423 W	551 W

Permissible Loads

The overview of these values are shown in the table below.

Hager reference	Outer dimensions H x W x D / mm	Permissible loads / kg	
		Cabinet	Door(s)
ZAL52US	1,710 x 583 x 277	50	1
ZAL53US	1,710 x 838.5 x 277	50	1
ZAL72US	2,010 x 583 x 277	50	1
ZAL73US	2,010 x 838.5 x 277	50	1

General Remarks

The built-in switching devices and components have to be chosen considering the requirements of outdoor application (e.g. concerning humidity and temperature conditions). Consultation of the manufacturer's technical documentation is mandatory. Should it be impossible to guarantee the ambient temperature limits defined in IEC 61439-1, it is imperative that the assembly manufacturer ensures the operating conditions for the switchgear assembly. Possible actions include, but are not limited to, installation in the shade, the use of a protective plate above the enclosure, the correct configuration of the switching devices concerning thermal tripping characteristics. Additionally, the rated diversity factor has to be considered. The same applies for extra low temperatures and high humidity. In any case, the assembly manufacturer must consider the climate conditions and needs to specify according to the desired use of the specific assembly.

3. Outdoor Pillars for Switchgear Devices

ZAK...A



Overview of series Outdoor Pillars for Switchgear Devices (ZAK...A)

Distribution & Metering Pillars ZAS		
Size	5	7
Width in mm	583	839
Height in mm		
1710		
Enclosure w/ busbar system:	ZAK175A	ZAK177A
2010		
Enclosure w/ busbar system:	ZAK205A	ZAK207A
Necessary Amount of ZAY95075:	2 bags	3 bags

Reference table outdoor enclosures for switchgear devices (ZAK...A)

Reference	Description
ZAK175A	Distribution Pillar, with busbar system, with base, 1710 x 583 x 277 mm
ZAK177A	Distribution Pillar, with busbar system, with base, 1710 x 839 x 277 mm
ZAK205A	Distribution Pillar, with busbar system, with base, 2010 x 583 x 277 mm
ZAK207A	Distribution Pillar, with busbar system, with base, 2010 x 839 x 277 mm

Interface characteristics

In respect to IEC 61439-1:2020 & IEC 61439-2:2020

Characteristic	Value
Voltage Ratings	
Rated voltage U_n	400 V
Rated operational voltage U_e	400 V
Rated insulation voltage U_i	1,000 V
Rated impulse withstand voltage U_{imp}	up to 8 kV (consider the values of the devices)
Current Ratings	
Rated current of the assembly I_{nA}	up to 299 A → compare to the verification of temperature rise
Rated conditional short-circuit current of an ASSEMBLY I_{cc}	40 kA (fuse switch disconnectors)
Rated diversity factor RDF	none
Rated frequency f_n	50 Hz

Other characteristics

In respect to IEC 61439-1:2020 & IEC 61439-2:2020

a) additional requirements depending on the use of a functional unit (e.g. type of coordination, overload characteristics)

None

b) pollution degree of the macro-environment (see 3.6.10.2)

III

c) types of earthing system for which the assembly is designed

TN, TT

d) indoor and/or outdoor installation (see 3.5.1 and 3.5.2)

Outdoor installation

The use of switching devices and other components need to be assessed and confirmed according to the intended climate conditions by the assembly manufacturer.

e) stationary or movable (see 3.5.3 and 3.5.4)

Stationary

f) degree of protection against contact with hazardous live parts, ingress of solid foreign bodies and water, IP code (See 8.2.2 of IEC 61439-1:2020)

IP44

g) intended for use by electrically skilled, competent or instructed persons (see 3.7.13, 3.7.14 and 3.7.15 of IEC 61439-1:2020)

Skilled persons

h) electromagnetic compatibility (EMC) classification (see Annex J)

i) special service conditions, if applicable (see 7.2)

no special service conditions

j) external design (see 3.3)

enclosed assembly (IP44)

k) degree of protection against mechanical impact, IK code, if applicable (see 8.2.1)

IK10

l) type of construction – fixed, removable or withdrawable parts (see 8.5.1 of IEC 61439-1:2020 and 8.5.2)

Fixed parts

m) type of short-circuit protective device(s) (see 9.3.2)

Only for use of vertical switchgear devices

n) measures for protection against electric shock

Protection class II

o) overall dimensions (including projections e.g handles, covers, doors), if required

Not required

p) weight, if required

Not required

q) installation method

in-ground mounting

r) external conductor type (see 8.8)

cable

s) direction of external conductors (see 8.8)

from below

t) external phase conductor, cross sections and terminations (see 8.8)

according to Annex A, termination depending on setup, mostly on clamps / terminals

u) external PEN conductor, cross sections and terminations (see 8.8)

according to table 5, IEC 61439-1, termination depending on setup mostly on clamps / terminals

aa) form of internal separation and associated degree of protection(s), IP code (see 8.101)

no internal separation, devices are fixed on 185 mm busbar system, empty areas are to be covered by empty field isolator plates ZAY47930

bb) types of electrical connections of functional units (see 8.5.101)
cables and terminals

cc) mounting orientation (horizontal, vertical, etc.) if the assembly can be mounted in different positions from vertical
devices are mounted vertically

Verification of temperature rise

The verification was performed by test as specified in 10.10.2 of IEC 61439-1:2020. The tested configurations were chosen in accordance with clause 10.10.2.2 as the most critical. The test was performed in accordance with 10.10.2.3.5 on the complete assembly.

Built-in Switching Devices and Components

- Fuse Rails

Type	Reference	I_n / A	Manufacturer
NH2	LVSG2CPX	400	Hager
NH00	LVSG00SPX	160	Hager

- Fuse Links

Type	Reference	I_n / A	U_n / V	P_v / W	Manufacturer
NH2	LNH2315M	315	500	25	Hager
NH2	LNH2160M	160	500	15	Hager
NH00	LNH0080M	80	500	6.5	Hager

The given energy dissipation P_v refers to the nominal current I_n .

- Tested enclosure

Height	Width	Depth	Reference	Busbars	Manufacturer	Type of reference
1710	583	277	ZAK175A	30 x 6	Hager	Standard-Produkt

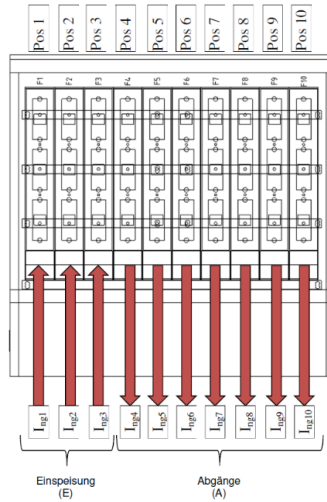

The ingoing current was evenly distributed over the supplying fuse rails:

$$I_{nA} = \sum_{i=1}^m I_{ngi}, \forall m = 1 \dots 3$$

The maximum current rating is therefore the sum of all ingoing currents. The currents must be distributed evenly.

All results are in relation to an average ambient temperature of 35 °C over a period of 24 hours.

I _{nA} / A	Supply		Busbar cross section	Minimum Enclosure	Outgoing		
	Fuse rail	Fuse gG / A			Enclosure	Fuse rail	Fuse gG / A
275	1xNH2	315	30x6	ZAK175A	3xNH2	160	137
299	1xNH2	315	30x6	ZAK175A	1xNH2	160 (NH2)	148 A (NH2)
					2xNH00	80 (NH00)	75 A (NH00)

Fuse factor $f = I_{ng} / I_N$.

On using the table above:

Depending on the needed nominal current, one must choose at least the shown ingoing set-up with the corresponding fuse links. Furthermore, one must mind the minimal enclosure size that is necessary to dissipate the temperature rise inside the enclosure.

The given maximum current I_{nA} can always be handled with an enclosure that is larger in volume. A bigger cross-section of the busbars is also possible (custom solutions can be delivered if requested).

Concerning the outgoing side, one must make sure to be compliant with the given current I_{ng} for the fuse rails. Should it be necessary to choose a smaller fuse link, the maximum current I_{ng} must be reduced by using the fuse factor f .

Example:

I_{nA} / A	Supply		Busbar cross section	Minimum Enclosure	Outgoing		
	Fuse rail	Fuse gG / A		Enclosure	Fuse rail	Fuse gG / A	I_{ng} / A
275	1xNH2	315	30x6	ZAK175A	3xNH2	160	137

If a current of 275 A shall be distributed in a cabinet, the supply must consist of a minimum of 1 x NH2 fuse rails with fuse links of 315 A.

To distribute this incoming current, a busbar system with a cross section of at least 30 x 6 mm² is needed. Thus, a compatible enclosure would be a standard product like ZAK75A or any other ZAK...A with a higher volume.

For the outgoing, NH2 fuse rails can be used. With fuse links of 160 A, they can distribute a maximum of 137 A in this assembly configuration. Using three NH2 fuse rails to distribute the incoming current, one rail can distribute 137 A while the remaining one will still distribute the rest current. Every other load configuration of the outgoing fuse rails is also possible as long as no rail distributes more than the maximum I_{ng} shown in the table.

If a smaller fuse link size is used, the fuse factor $f = I_{ng}/I_N = 137 A / 160 A = 0,86$ must be applied. If, for example, it is chosen to use fuse links of 125 A, the I_{ng} must be reduced accordingly:

$$I_{ng125} = 0,86 \times 125 A = 107 A.$$

This means that no outgoing fuse rail can distribute more than 107 A without causing a prohibited temperature-rise inside the assembly.

Permissible Loads

The overview of these values are shown in the table below.

Hager reference	Outer dimensions H x W x D / mm	Permissible loads / kg	
		Cabinet	Door(s)
ZAK175A	1,710 x 583 x 277	50	1
ZAK177A	1,710 x 838.5 x 277	50	1
ZAK205A	2,010 x 583 x 277	50	1
ZAK207A	2,010 x 838.5 x 277	50	1

General Remarks

The built-in switching devices and components have to be chosen considering the requirements of outdoor application (e.g. concerning humidity and temperature conditions). Consultation of the manufacturer's technical documentation is mandatory. Should it be impossible to guarantee the ambient temperature limits defined in IEC 61439-1, it is imperative that the assembly manufacturer ensures the operating conditions for the switchgear assembly. Possible actions include, but are not limited to, installation in the shade, the use of a protective plate above the enclosure, the correct configuration of the switching devices concerning thermal tripping characteristics. Additionally, the rated diversity factor has to be considered. The same applies for extra low temperatures and high humidity. In any case, the assembly manufacturer must consider the climate conditions and needs to specify according to the desired use of the specific assembly.

4. Street Lighting Pillars

ZAB205AP0X



Interface characteristics

In respect to IEC 61439-1:2020 & IEC 61439-2:2020

Characteristic	Value
Voltage Ratings	
Rated voltage U_n	400 V
Rated operational voltage U_e	400 V
Rated insulation voltage U_i	1,000 V
Rated impulse withstand voltage U_{imp}	up to 6 kV (consider the values of the devices)
Current Ratings	
Rated current of the assembly I_{nA}	63 A
Rated conditional short-circuit current of an ASSEMBLY I_{cc}	25 kA (MCBs) / 120 kA (house connection fuse links)
Rated diversity factor RDF	none
Rated frequency f_n	50 Hz

Other characteristics

In respect to IEC 61439-1:2020 & IEC 61439-2:2020

a) additional requirements depending on the use of a functional unit (e.g. type of coordination, overload characteristics)

None

b) pollution degree of the macro-environment (see 3.6.10.2)

III

c) types of earthing system for which the assembly is designed

TN, TT

d) indoor and/or outdoor installation (see 3.5.1 and 3.5.2)

Outdoor installation

The use of switching devices and other components need to be assessed and confirmed according to the intended climate conditions by the assembly manufacturer.

e) stationary or movable (see 3.5.3 and 3.5.4)

Stationary

f) degree of protection against contact with hazardous live parts, ingress of solid foreign bodies and water, IP code (See 8.2.2 of IEC 61439-1:2020)

IP44

g) intended for use by electrically skilled, competent or instructed persons (see 3.7.13, 3.7.14 and 3.7.15 of IEC 61439-1:2020)

Skilled persons

h) electromagnetic compatibility (EMC) classification (see Annex J)

i) special service conditions, if applicable (see 7.2)

no special service conditions

j) external design (see 3.3)

enclosed assembly (IP44)

k) degree of protection against mechanical impact, IK code, if applicable (see 8.2.1)

IK10

l) type of construction – fixed, removable or withdrawable parts (see 8.5.1 of IEC 61439-1:2020 and 8.5.2)

Fixed parts

m) type of short-circuit protective device(s) (see 9.3.2)

Integrated house connection box with NH00 fuse links (max. 100 A)

n) measures for protection against electric shock

Protection class II

o) overall dimensions (including projections e.g handles, covers, doors), if required

Not required

p) the weight, if required

Not required

q) installation method

in-ground mounting

r) external conductor type (see 8.8)

cable

s) direction of external conductors (see 8.8)

from below

t) external phase conductor, cross sections and terminations (see 8.8)

6-95 mm² re/rm/se/sm on V-clamp inside house connection box

u) external PEN conductor, cross sections and terminations (see 8.8)

6-95 mm² re/rm/se/sm on V-clamp inside house connection box

aa) form of internal separation and associated degree of protection(s), IP code (see 8.101)

**back side: mounting plate; side: univers N vertical separator parts (polystyrene);
top and bottom: univers N Stirnteile (polyamide); front: univers N front covers closed or
slotted (polystyrene); IP code with open door: IP3X**

bb) types of electrical connections of functional units (see 8.5.101)

cables and terminals

cc) mounting orientation (horizontal, vertical, etc.) if the assembly can be mounted in different positions from vertical

devices are mounted horizontally on DIN rails

General Remarks

The built-in switching devices and components have to be chosen considering the requirements of outdoor application (e.g. concerning humidity and temperature conditions). Consultation of the manufacturer's technical documentation is mandatory. Should it be impossible to guarantee the ambient temperature limits defined in IEC 61439-1, it is imperative that the assembly manufacturer ensures the operating conditions for the switchgear assembly. Possible actions include, but are not limited to, installation in the shade, the use of a protective plate above the enclosure, the correct configuration of the switching devices concerning thermal tripping characteristics. Additionally, the rated diversity factor has to be considered. The same applies for extra low temperatures and high humidity. In any case, the assembly manufacturer must consider the climate conditions and needs to specify according to the desired use of the specific assembly.

5. Metering Cabinets

ZAS131... / ZAS132...



Overview of series Metering Cabinets (ZAS131... / ZAS132...)



Cable Distribution Cabinets KVS (CDC)		
Size	1	2
Width in mm	780	1110
Height in mm	Depth: 315 mm	
1355		
Metering cabinets	ZAS131BD45A	ZAS132...
Necessary Amount of ZAY95075:	3 bags	4 bags

Reference table Metering Cabinets (ZAS131... / ZAS132...)

Reference	Description
ZAS131BD45A	Meter Cabinet, universZ, 2 meter panels, 3.dsm, 5-pole, empty panell, Basic, APZ
ZAS132BD65A	Meter Cabinet, universZ, 2 meter panels, 3.dsm, 5-pole, 2 empty panels, Basic, APZ
ZAS132BE65A	Meter Cabinet, universZ, 2 meter panels, EHZ, 5-pole, 2 empty panels, Basic, APZ

Measurements in accordance with DIN 43629-1

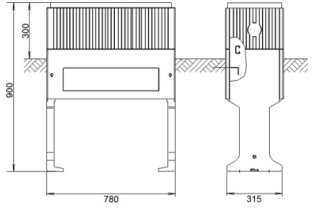
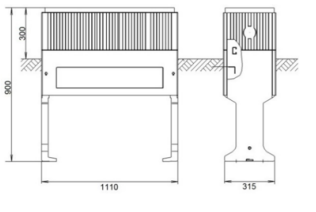
Pedestals

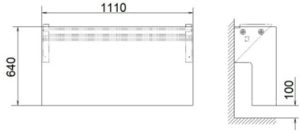
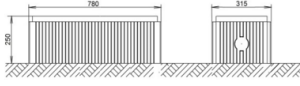
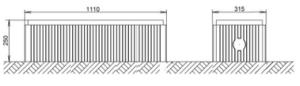
Univers N Enclosures KVS (CDC)		
Size	1	2
Width in mm	780	1110
Necessary Amount of ZAY95075:	3 bags	4 bags
Pedestal ZAX - Standard		
900		
	ZAX006	ZAX007
Pedestal ZAX - Wall Console		
640		
	ZAX012	ZAX013
Pedestal ZAX - On-ground pedestal		
250		
	ZAX015	ZAX016

Reference table Pedestals for Cable Distribution Cabinets

Reference	Description
ZAX006	Embedded pedestal, size 1, height: 900 mm
ZAX007	Embedded pedestal, size 2, height: 900 mm
ZAX012	Wall console, size 1, height: 640 mm
ZAX013	Wall console, size 2, height: 640 mm
ZAX015	Surface-mounted base, size 1, height: 250 mm
ZAX016	Surface-mounted base, size 2, height: 250 mm

Measurements in accordance with DIN 43629-2

Interface characteristics

In respect to IEC 61439-1:2020 & IEC 61439-2:2020

Characteristic	Value
Voltage Ratings	
Rated voltage U_n	400 V
Rated operational voltage U_e	400 V
Rated insulation voltage U_i	1,000 V
Rated impulse withstand voltage U_{imp}	up to 6 kV (consider the values of the devices)
Current Ratings	
Rated current of the assembly I_{nA}	up to 63 A
Rated conditional short-circuit current of an ASSEMBLY I_{cc}	25 kA (MCBs) / 120 kA (house connection fuse links)
Rated diversity factor RDF	none
Rated frequency f_n	50 Hz

Other characteristics

In respect to IEC 61439-1:2020 & IEC 61439-2:2020

a) additional requirements depending on the use of a functional unit (e.g. type of coordination, overload characteristics)

None

b) pollution degree of the macro-environment (see 3.6.10.2)

III

c) types of earthing system for which the assembly is designed

TN

d) indoor and/or outdoor installation (see 3.5.1 and 3.5.2)

Outdoor installation

The use of switching devices and other components need to be assessed and confirmed according to the intended climate conditions by the assembly manufacturer.

e) stationary or movable (see 3.5.3 and 3.5.4)

Stationary

f) degree of protection against contact with hazardous live parts, ingress of solid foreign bodies and water, IP code (See 8.2.2 of IEC 61439-1:2020)

IP44, except defined ventilation area: **IP34D**

g) intended for use by electrically skilled, competent or instructed persons (see 3.7.13, 3.7.14 and 3.7.15 of IEC 61439-1:2020)

Skilled persons

h) electromagnetic compatibility (EMC) classification (see Annex J)

i) special service conditions, if applicable (see 7.2)

no special service conditions

j) external design (see 3.3)

enclosed assembly (IP44/IP34D)

k) degree of protection against mechanical impact, IK code, if applicable (see 8.2.1)

IK10

l) type of construction – fixed, removable or withdrawable parts (see 8.5.1 of IEC 61439-1:2020 and 8.5.2)

Fixed parts

m) type of short-circuit protective device(s) (see 9.3.2)

Integrated house connection box with NH00 fuse links (max. 100 A)

n) type of short-circuit protective device(s) (see 9.3.2)

Protection class II

o) overall dimensions (including projections e.g handles, covers, doors), if required

Not required

p) the weight, if required

Not required

q) installation method

in-ground pedestal, on-ground pedestal, wall console (see overview for ZAL...U)

r) external conductor type (see 8.8)

cable

s) direction of external conductors (see 8.8)

from below

t) external phase conductor, cross sections and terminations (see 8.8)

6-95 mm² re/rm/se/sm on V-clamp inside house connection box

u) external PEN conductor, cross sections and terminations (see 8.8)

6-95 mm² re/rm/se/sm on V-clamp inside house connection box

aa) form of internal separation and associated degree of protection(s), IP code (see 8.101)

**back side: mounting plate; side: univers Z vertical separator parts (polystyrene);
top and bottom: univers Z Stirnteile (polyamide); front: univers Z front covers closed or
slotted (polystyrene); IP code with open door: IP3X**

bb) types of electrical connections of functional units (see 8.5.101)

cables and terminals

cc) mounting orientation (horizontal, vertical, etc.) if the assembly can be mounted in different positions from vertical

devices are mounted horizontally on DIN rails

General Remarks

The built-in switching devices and components have to be chosen considering the requirements of outdoor application (e.g. concerning humidity and temperature conditions). Consultation of the manufacturer's technical documentation is mandatory. Should it be impossible to guarantee the ambient temperature limits defined in IEC 61439-1, it is imperative that the assembly manufacturer ensures the operating conditions for the switchgear assembly. Possible actions include, but are not limited to, installation in the shade, the use of a protective plate above the enclosure, the correct configuration of the switching devices concerning thermal tripping characteristics. Additionally, the rated diversity factor has to be considered. The same applies for extra low temperatures and high humidity. In any case, the assembly manufacturer must consider the climate conditions and needs to specify according to the desired use of the specific assembly.