























| | |
|--------------------------------|---|
| Application description |  |
|--------------------------------|---|























Motion detector KNX-BCU

Electrical/mechanical data: see the operating instructions for the product

| | Order number | Product designation | Application programme | TP product  Radio product  |
|---|---------------------|----------------------------|---|--|
|  | WST502 - | Motion detector KNX-BCU |  |  |

Inhaltsverzeichnis

| | |
|---|----|
| 1. General | 4 |
| 1.1 General information about this application description | 4 |
| 1.2 Programming software configuration tool..... | 4 |
| 1.3 Commissioning..... | 4 |
| 2. Functional and device description | 5 |
| 2.1 Device overview | 5 |
| 2.2 Functional description | 6 |
| 2.3 Operating concept..... | 6 |
| 2.3.1 Operating instructions..... | 6 |
| 2.3.2 Range of functions..... | 6 |
| 2.4 Functional overview | 8 |
| 2.4.1 No function  | 8 |
| 2.4.2 Lighting  | 8 |
| 2.4.3 Dimming  | 9 |
| 2.4.4 Roller shutter  | 10 |
| 2.4.5 Heating/cooling  | 12 |
| 3. Project preparation | 13 |
| 3.1 Project editing | 13 |
| 3.2 Device choice..... | 14 |
| 3.2.1 Menu field - parameters..... | 14 |
| 3.3 Overview inputs/outputs..... | 16 |
| 3.3.1 Individual application..... | 16 |
| 3.3.2 Master..... | 17 |
| 3.3.3 Slave..... | 17 |
| 4. Configuring motion inputs | 18 |
| 4.1 Lighting functions  | 19 |
| 4.1.1 Timer function  | 19 |
| 4.1.2 Automatic ON  | 20 |
| 4.1.3 Automatic OFF  | 21 |
| 4.1.4 Automatic control switching  | 21 |
| 4.1.5 Scene function  | 22 |
| 4.1.6 Scene switching  | 23 |
| 4.1.7 Overview of all possible linking combinations..... | 24 |
| 4.2 Dimming functions  | 25 |
| 4.2.1 Automatic dimming  | 25 |
| 4.2.2 Automatic dimming switching  | 26 |
| 4.2.3 Scene function  | 26 |
| 4.2.4 Scene switching function  | 26 |

| | | |
|--------|---|----|
| 4.2.5 | Overview of all possible linking combinations..... | 27 |
| 4.3 | Roller shutter functions  | 28 |
| 4.3.1 | Basis roller shutter/blind control..... | 28 |
| 4.3.2 | Roller shutter up/down functions  | 31 |
| 4.3.3 | Roller shutter down/up functions  | 31 |
| 4.3.4 | Switching up function  | 32 |
| 4.3.5 | Switching down function  | 32 |
| 4.3.6 | Automatic roller shutter position function  | 32 |
| 4.3.7 | Automatic slat position function  | 33 |
| 4.3.8 | Automatic roller shutter and slat position functions  | 33 |
| 4.3.9 | Automatic roller shutter position function  | 34 |
| 4.3.10 | Automatic slat angle switching function  | 34 |
| 4.3.11 | Automatic roller shutter slat position switching function  | 35 |
| 4.3.12 | Scene function  | 35 |
| 4.3.13 | Scene switching function  | 35 |
| 4.3.14 | Overview of all possible linking combinations..... | 36 |
| 4.4 | Heating/cooling functions  | 37 |
| 4.4.1 | Automatic Comfort mode function  | 37 |
| 4.4.2 | Automatic Standby mode function  | 38 |
| 4.4.3 | Automatic Eco mode function  | 38 |
| 4.4.4 | Automatic Protection mode function  | 38 |
| 4.4.5 | Automatic mode switching function  | 39 |
| 4.4.6 | Scene function  | 39 |
| 4.4.7 | Scene switching function  | 39 |
| 4.4.8 | Overview of all possible linking combinations..... | 40 |
| 5. | Master-slave application  | 41 |
| 6. | Internal temperature sensor  | 43 |
| 7. | Appendix | 44 |
| 7.1 | Technical data - performances..... | 44 |
| 8. | Table of Figures..... | 45 |
| 9. | List of tables..... | 47 |

1. General

1.1 General information about this application description

This document describes the programming and parameterisation of easy compliant KNX products with the aid of the *configuration tool*.



1.2 Programming software configuration tool

The application programs for the KNX products are already preinstalled in the configuration tool.

-  If the current application software is not available in the configuration tool, then the configuration tool must be updated (see "Configuration tool" installation handbook).

1.3 Commissioning

The commissioning process for the motion detector (PIR) refers primarily to the linking of the motion channels (referred to in the information that follows as inputs) and the switch actuator outputs (referred to in the information that follows as outputs) as well as the selection of the respective functions (Switching, Dimming, Roller shutter/blind, etc.).

-  The commissioning process for the configuration tool can be found in the corresponding instructions.
-  Programming with the configuration tool is restricted to just one bus line and does not require a line coupler. As a result, it is possible to combine wired and wireless-network (quicklink ) KNX devices.

2. Functional and device description

2.1 Device overview

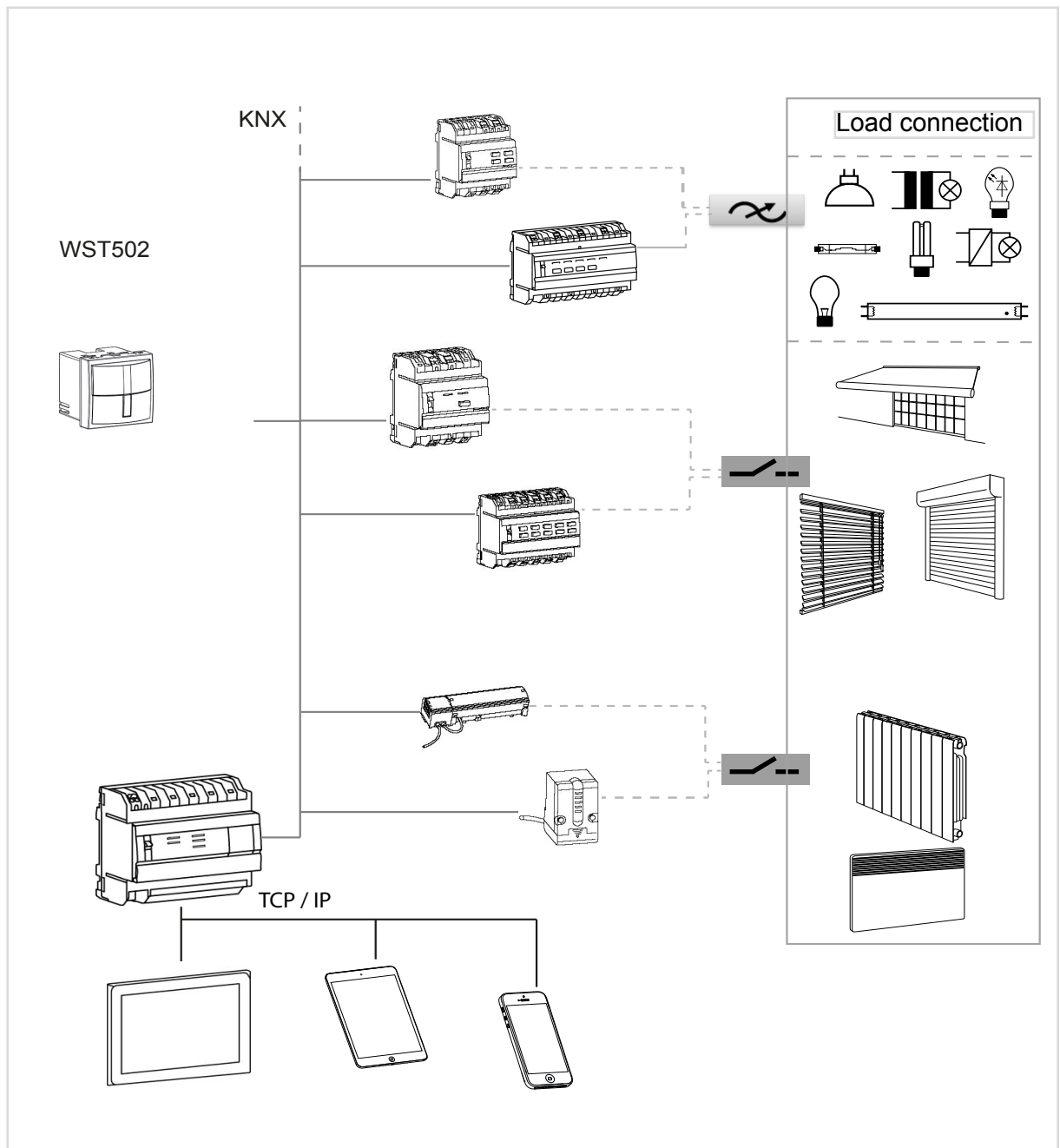

Figure 1: Device overview

2.2 Functional description

The motion detector module works with a passive infrared sensor (PIR) and responds to heat motions caused by persons, animals or objects. Motion detectors are primarily used in hallways or staircases as a means of switching lights on and off based on brightness levels and motion.

Based on the set parameters, the device transmits telegrams for directing the building functions into the bus system. There is the option of transmitting Switching, Dimming, Roller shutter or Heating/cooling telegrams to the bus. Two independent channels are available.

The device can be operated manually using the knob at the front. It is also possible to configure the device manually using the potentiometer under the design cover.

2.3 Operating concept

The operation button on the front of the motion detector can perform the following functions (see operating instructions also):

- Press and release the button to change over the operating mode. The operating mode is displayed via the status LED behind the cover of the motion detector.
- Press and hold down the button to select special functions. Selection is supported by the LED display.

 It is not possible to perform any push-button functions using the operation button; that is, the button on the device can only be used to set the three operating modes and the special functions.

2.3.1 Operating instructions

During KNX button use, the device differentiates between short and long touches (see the device operating instructions).

- Short repeating touches:
Select operating mode (Permanent ON, Automatic, Permanent OFF)
- Long touches (hold time):
Select special functions (party function, Teach-In, keylock, presence simulation)

2.3.2 Range of functions

- Motion detectors can be configured as an individual application, a master or a slave.
- Two motion detection channels can be configured independently for automatic control purposes, using Switching/Timer, Dimming, Scene, Roller shutter/blind control and Heating/cooling functions.
- The detection area can be activated on the left and right.
- The detection area can be changed using adjusters on the device.
- The potentiometers for response brightness, delay time and sensitivity can be adjusted on the device.
- Button functions for local operation of the operating mode (ON, OFF, Automatic) and special functions (party function, Teach-In, keylock, presence simulation).
- 2-channel operation: The operation can be set by two independent channels. Thus, a maximum of two telegrams can only be transmitted to the bus by one detection procedure. The parameters for the channels can be set to the Lighting, Dimming, Roller shutter and Heating/cooling functions independently of one another.

Lighting:

Each input can be assigned one of the following functions: "Timer, Automatic ON, Automatic OFF, Automatic switching, Scene, and Scene switching".

Dimming:

Each input can be assigned one of the following functions: "Automatic dimming, Automatic dimming switching, Scene, and Scene switching".

Roller shutter:

Each button can be assigned one of the following functions: "Blind/roller shutter up/down, Automatic roller shutter position, Automatic slat angle, Automatic roller shutter and slat position, Scene, and Scene switching".

Heating/cooling:

Each button can be assigned one of the following functions: "Automatic Comfort mode, Automatic Eco mode, Automatic Standby mode, Automatic Protection mode (frost protection), Scene, and Scene switching".

- An RGB status LED for displaying the button function.
- Room temperature measurement and brightness measurement using integrated sensors
- Temperature measuring and transmission to the bus.

2.4 Functional overview

The functions described in the following section enable the individual configuration of the device inputs or outputs.

2.4.1 No function

The **No function** function means that no function is assigned to the button. The button is disabled.

2.4.2 Lighting

Timer

The **Timer** function enables the actuator output to be switched on for an adjustable duration. The switching time can be interrupted before the delay time elapses. An adjustable switch-off warning signals the end of the delay time by inverting the output state for 1 s. The timer duration and the switch-off warning, if applicable, must be set in the switch actuator.

Automatic ON

The **Automatic ON** function is used to switch on the corresponding actuator output during motion detection. To switch off this output again, an OFF command must be issued by another device, such as a push-button.

Automatic OFF

The **Automatic OFF** function is used to switch off the corresponding actuator output during motion detection. To switch this output back on, an ON command must be issued by another device, such as a push-button.

Automatic control switching

The **Automatic control switching** function is used to switch on the corresponding actuator output during motion detection for the time set on the device. Once this time has elapsed, the output is switched off again.

Scene

In the **Scene** function, several switching/dimming/blind outputs can be grouped together and switched on during motion detection. It is possible to choose from a maximum of 8 scenes.

Scene switching

This function can be used to switch between two scenes during motion detection.

Communication commands Lighting function

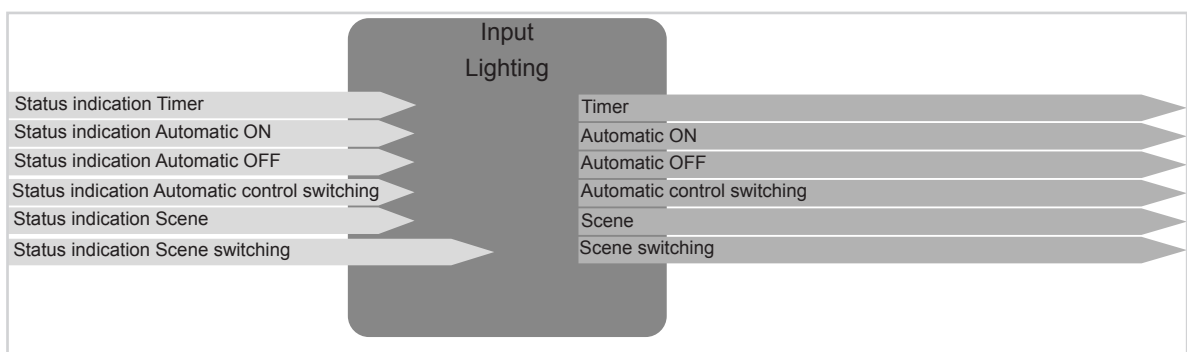

Figure 2: Input/output signals Lighting function

2.4.3 Dimming

Automatic dimming

With the **Automatic dimming** function, the dimming output that is configured in each case is switched on at a set dimming value during motion detection. To switch off this output again, a command must be issued by another device, such as a push-button.

Automatic dimming switching

With the **Automatic dimming switching** function, the set dimming value 1 is switched on first during motion detection; once the time set on the device has elapsed, a switch is then made to the second value, dimming value 2.

Scene

In the **Scene** function, several switching/dimming/blind outputs can be grouped together and switched on/off at the touch of a button. A maximum of 8 scenes can be created.

Scene switching

This function can be used to switch between two scenes during motion detection.

Communication commands Function dimming

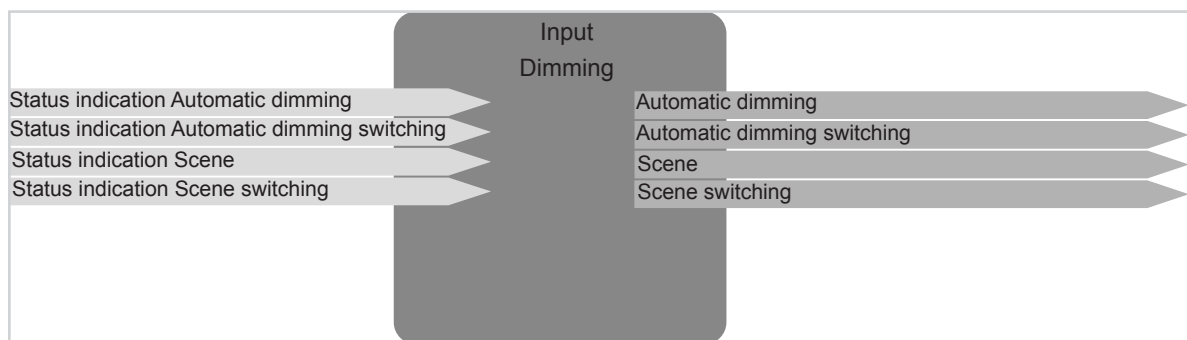

Figure 3: Input/output signals Dimming function

All functions from the **Lighting** function group can be linked with a dimming output. However, only the relevant **switching command** is executed in the ON/OFF output.

2.4.4 Roller shutter

The shutter" function allows blinds, shutters, awnings or similar hangings to be opened and closed.

Up/down

With this function, the roller shutter/blind is moved to the top final position during motion detection. Once the time set on the device has elapsed, the roller shutter/blind is moved to the bottom final position (operation times to the top/bottom final position must be set in the relevant roller shutter output).

Down/up

With this function, the roller shutter/blind is moved to the bottom final position during motion detection. Once the time set on the device has elapsed, the roller shutter/blind is moved to the bottom final position (operation times to the top/bottom final position must be set in the relevant roller shutter output).

Up switching / Down switching

With these functions, the roller shutter is moved into either the top or the bottom final position during motion detection, and can be moved in the opposite direction by a command from a push-button, for example.

Automatic roller shutter position

With this function, the roller shutter is moved to the set position during motion detection.

Automatic slat position

With this function, the slat angle setting is moved to the set position during motion detection.

Automatic roller shutter and slat position

With this function, the roller shutter/blind and the slat angle are moved to the set position during motion detection.

Automatic roller shutter position

With this function, the roller shutter is moved to set Position 1 during motion detection and then, when the set delay time has elapsed, to Position 2.

Automatic slat angle switching

With this function, the slat angle is changed to the Slat angle 1 position during motion detection and then, when the delay time has elapsed, to the Slat angle 2 position.

Automatic roller shutter slat position switching

With this function, the roller shutter/blind is moved to Position 1/Slat angle 1 during motion detection and then, when the delay time has elapsed, to Position 2/Slat angle 2.

Scene

In the **Scene** function, several switching/dimming/blind outputs can be grouped together and switched on/off at the touch of a button. A maximum of 8 scenes can be created.

Scene switching

This function can be used to switch between two scenes during motion detection.

Communication commands Function roller shutter

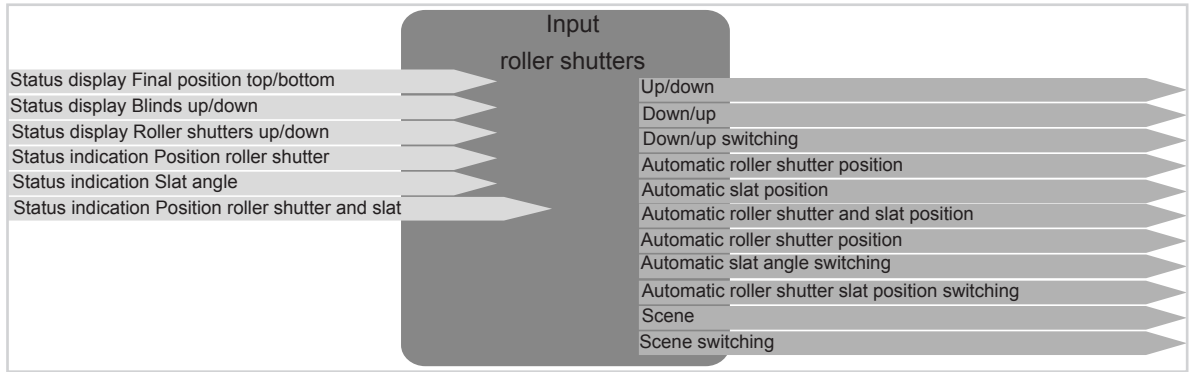





Figure 4: Input/output signals Roller shutter function

2.4.5 Heating/cooling

Operating mode

- Automatic Comfort mode 
- Automatic Eco mode 
- Automatic Standby mode 
- Automatic Protection mode 

With one of these functions, a switch is made to the relevant operating mode – Comfort, Eco, Standby or Protection – during motion detection.

Automatic mode switching

With this function, heating/cooling mode 1 is set during motion detection and, after a set delay time, heating/cooling mode 2 is set.

Scene

In the **Scene** function, several switching/dimming/blind outputs can be grouped together and switched on/off at the touch of a button. A maximum of 8 scenes can be created.

Scene switching

This function can be used to switch between two scenes during motion detection.

Communication commands Heating/cooling function

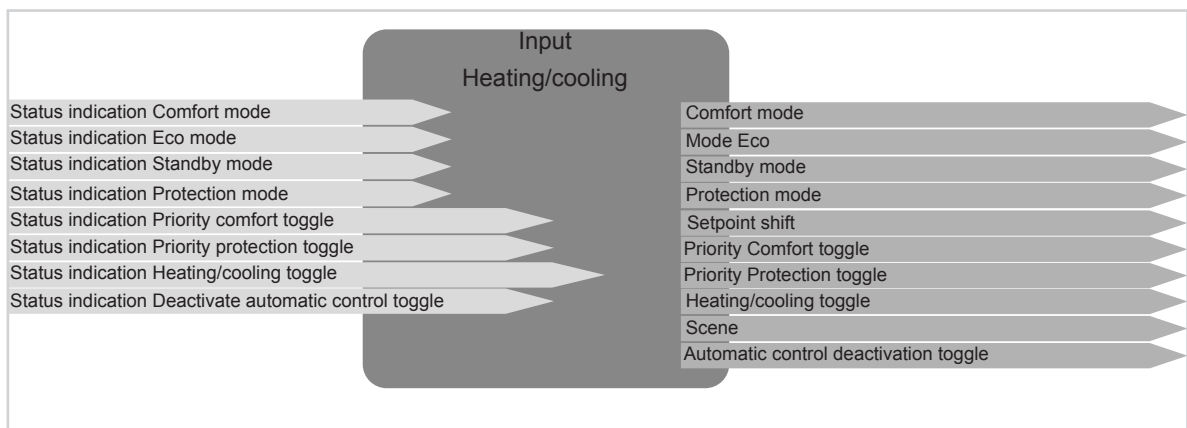

Figure 5: Input/output signals Heating/cooling function

3. Project preparation

The following sections describe the configuration of the parameters for motion detector module 1.10 m devices.

i The **configuration tool** is used for parameterisation and commissioning.

If all devices are integrated into the project, then you can start configuring the device.

3.1 Project editing

To ensure that the commissioning process with the **configuration tool** is successful, the following requirements must be met:

- ✓ A network connection to the **configuration tool** has been established.
- ✓ All of the devices used (wired and wireless) are connected to the **configuration tool**.
- ✓ Start the **configuration tool** software (browser version or tablet app).
- ✓ Create the project and enter the project-specific data (project name, address, customer data).
- ✓ Click on search to scan devices.

The **configuration tool** has scanned the device and started with the parameterisation.

3.2 Device choice

First of all, the corresponding device must be selected in the device listing to make it possible to start with the configuration.

- Click on the **KNX-BCU motion detector** in the ► device overview.

The following view opens (Figure 6).

All of the device inputs and device outputs are listed on the right-hand side (Figure 6, 1).

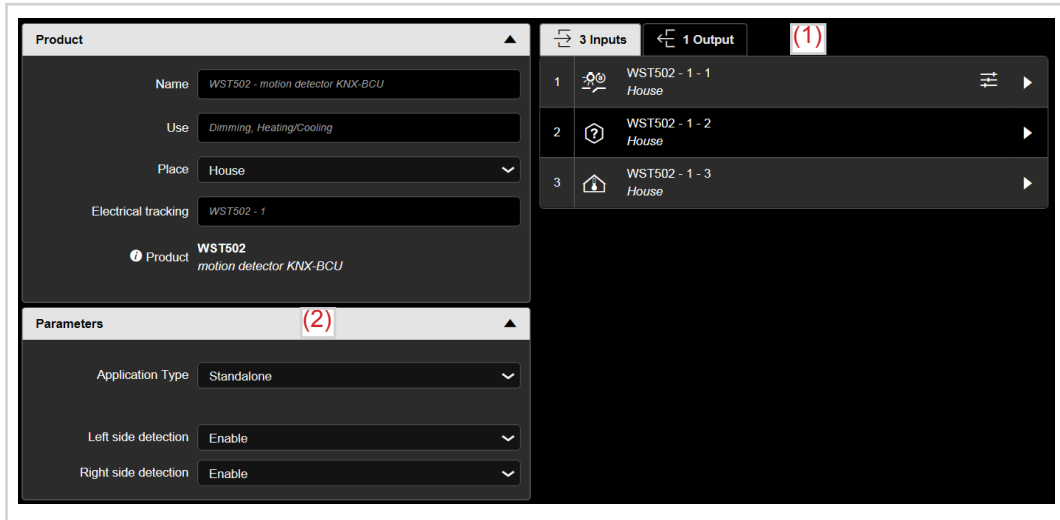

Figure 6: Device information

3.2.1 Menu field - parameters

The settings for the detection area and the type of application must be made under Parameters (Figure 6, 2). These settings are made for the complete device.

| Detection of the left/right side | |
|----------------------------------|--|
| Active | |
| Active | |

Table 1: Activating/deactivating the detection area

| Parameters | Description | Value |
|-----------------------------|---|-------------------------------|
| Detection of the left side | The parameter is used to activate/deactivate evaluation of the motions for the motion detector independently at the left and right sides of the device. | Not active Active * |
| Detection of the right side | | Not active Active * |

Table 2: Setting the detection area parameters

In addition to activating/deactivating the detection area in the device SA, it is possible to restrict the detection angle for the left side and for the right side between 45° ... 90° for each adjuster. This can be carried out on the device. This allows the detection angle to be set between 90° and 180° (Figure 7).

* Default value

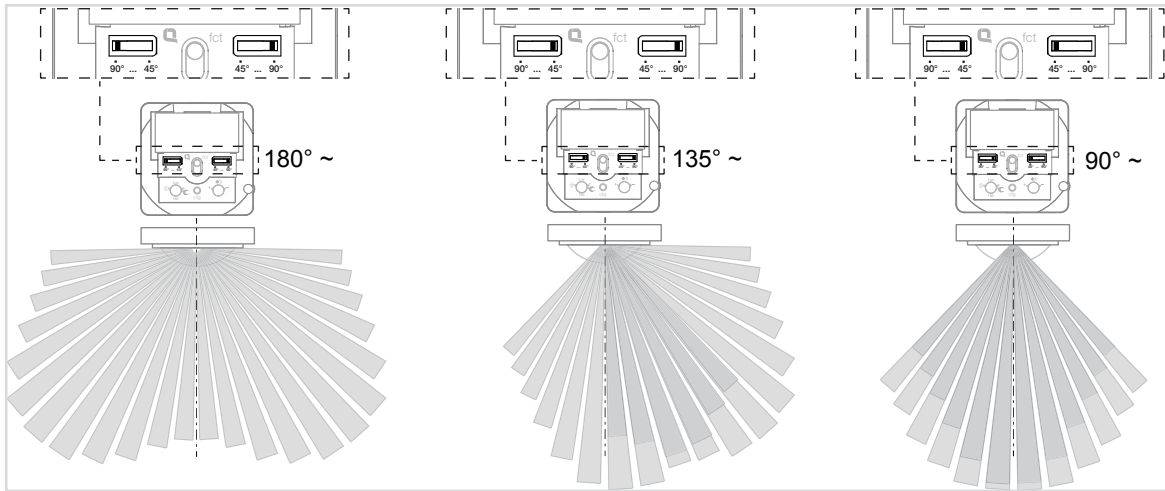

Figure 7: Setting the detection angle

In addition to setting the detection angles (left/right), it is possible to set the application for the motion detector. The device has three specific applications:

- Individual application

The individual application is the default device version that is used. It is used in cases where individual rooms or small spaces need to be monitored.

- Master

- Slave

The master or slave application must only be used in a combination of these two versions. One device, acting as the master, is linked to one or more slave devices (depending on the size of the monitoring area). This version is particularly suitable for monitoring staircases, large hallways and large rooms.

| Application |
|------------------------|
| Individual application |
| Master |
| Slave |

Table 3: Setting the application

| Parameters | Description |
|--------------------------|--|
| Individual application * | With this parameter, the motion detector for the application is set as an individual device (i.e. a standalone device). |
| Master | With this parameter, the motion detector for the application is set as the master device . |
| Slave | With this parameter, the motion detector for the application is set as the slave device . <i>i</i> This version requires a second motion detector to act as a master device. |

Table 4: Selecting the device application

* Default value

3.3 Overview inputs/outputs

The number of device inputs and outputs is determined by the device application used (**individual application**, **master device**, **slave device**).

The figures below show the inputs for the motion detector on the left-hand side and the outputs for the motion detector on the right-hand side.

3.3.1 Individual application





| 3 inputs | | 1 output | |
|---|------------------------|--|---|
|  | WST502 - 1 -1 House |  | WST502 - 1 -1 House - common functions |
|  | WST502 - 1 -2 House | | |
|  | WST502 - 1 -3 House | | |

Table 5: Overview of inputs/outputs - individual application

In the **individual application** version, the device has three inputs and one output.

- Inputs 1 - 2
The "Lighting – Dimming – Roller shutter – Heating/cooling" functions can be assigned to inputs 1 - 2.
- Input 3
The **Room temperature** function is assigned to this input permanently.

Outputs refer to functions which are triggered by pressing another button.

- Output 1:
This output can be used to deactivate the motion detector function.

3.3.2 Master





| 3 inputs | | 2 outputs | |
|---|------------------------|--|---|
|  | WST502 - 1 -1 House |  | WST502 - 1 -1 House - common functions |
|  | WST502 - 1 -2 House |  | WST502 - 1 -2 House - common functions |
|  | WST502 - 1 -3 House | | |

Table 6: Overview of inputs/outputs - master

In the **master** version, the device has three inputs and two outputs.

- Inputs 1 - 2
The "Lighting – Dimming – Roller shutter – Heating/cooling" functions can be assigned to inputs 1 - 2.
- Input 3
The **Room temperature** function is assigned to this input permanently.

Outputs refer to functions which are triggered by pressing another button or by another motion detector (slave).

- Output 1:
This output is used to deactivate the motion detector function.
- Output 2:
This output is used to forward the motion detector function to a slave device.

3.3.3 Slave



| 1 inputs | | 1 output | |
|---|------------------------|--|---|
|  | WST502 - 1 -1 House |  | WST502 - 1 -1 House - common functions |
|  | WST502 - 1 -2 House | | |

Table 7: Overview of inputs/outputs - slave

In the **slave** version, the device has two inputs and one output.

- Input 1
The "Room temperature" function is assigned to this input permanently.
- Input 2
The "Motion detection" function is assigned to this input permanently. This function operates in conjunction with the corresponding master function.

Outputs refer to functions which are triggered by pressing another button or by another motion detector (slave).

- Output 1:
This output can be used to deactivate the motion detector function.

4. Configuring motion inputs

The next section describes the functions that need to be executed during motion detection. The first motion input is described in each case. The next input must then be configured accordingly. The functions of the inputs are divided into the following function groups.

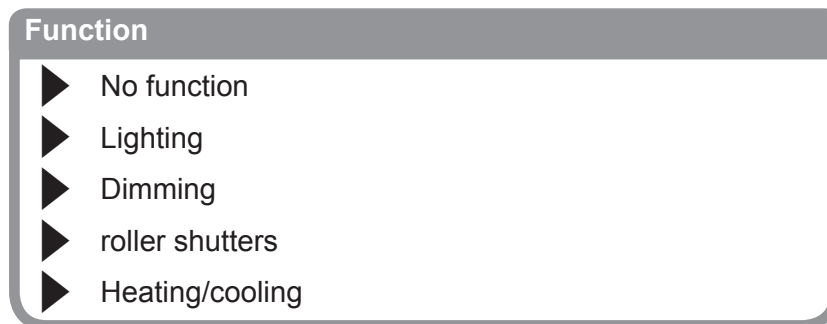

Figure 8: Function selection of the independent push-button

The **No Function** function is preset at the beginning of the parameterisation. This means that the relevant channel is not active.

The **Lighting**, **Dimming**, **Roller shutter** and **Heating/cooling** functions have different sub-functions, which are described in the following sections.

| Parameters | Description | Value |
|-----------------|--|--|
| No function * | The input has no function (inactive). | |
| Lighting | This parameter sets the function of the channel under Lighting . | Timer Automatic ON Automatic OFF Automatic control switching Scene Scene switching |
| Dimming | This parameter sets the function of the channel under Dimming . | Automatic dimming Automatic dimming switching Scene Scene switching |
| roller shutters | This parameter sets the function of the channel under Roller shutter . | Up/down Down/up Up switching Down switching Automatic roller shutter position toggle Automatic slat position toggle Automatic roller shutter and slat position toggle Automatic roller shutter position switching Automatic slat angle switching Automatic roller shutter slat position switching Scene Scene switching |
| Heating/cooling | This parameter sets the function of the channel under Heating/cooling . | Automatic Comfort mode Automatic Eco mode Automatic Standby mode Automatic Protection mode Automatic mode switching Scene Scene switching |

Table 8: Function during motion detection

* Default value

4.1 Lighting functions

The "Lighting" function is used to switch the lighting or socket circuits on/off with a switch actuator.

All of the combination possibilities between inputs – outputs/inputs are listed at the end of the chapter.

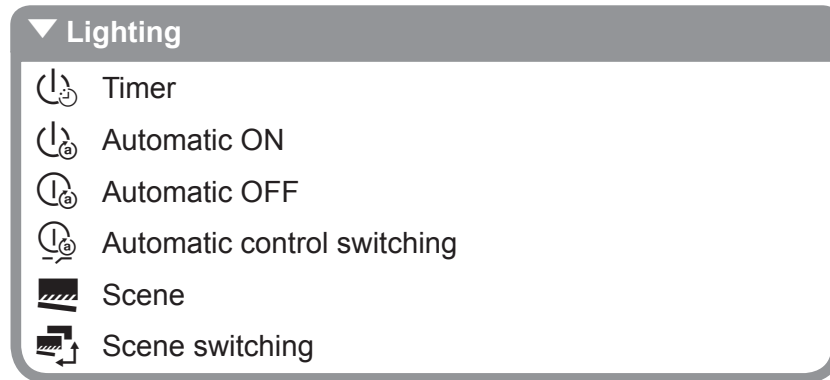

Figure 9: Functional overview lighting

4.1.1 Timer function

The **Timer** function enables the ON/OFF output to be switched on for an adjustable duration. The switching time can be interrupted before the delay time elapses. An adjustable switch-off warning signals the end of the delay time by inverting the output state for 1 s. The timer duration and the switch-off warning must be set in the switch actuator.

| Inputs | | | Outputs | |
|--------|------------------------------|--|---------|---|
| | WST502 - 1-2 <i>House</i> | | | TXA610 - - 1-1 <i>House - lighting</i> |

Figure 10: Linking **Timer** function

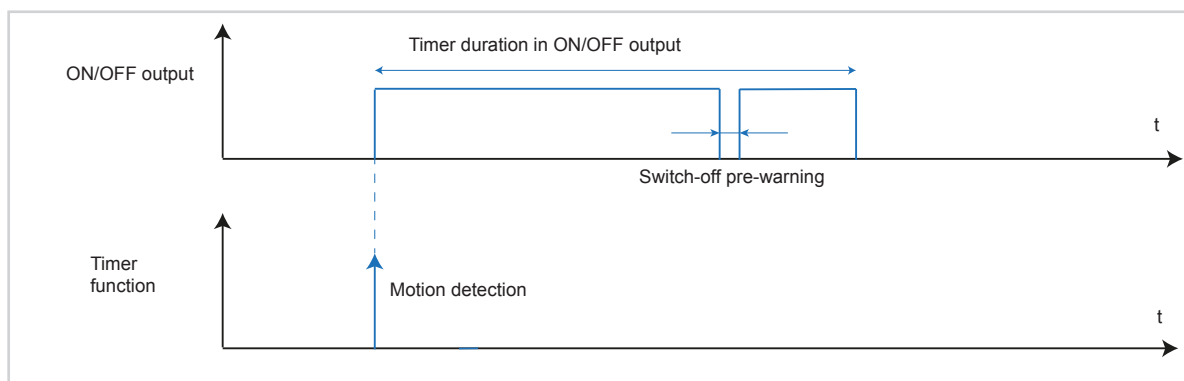

Figure 11: Signal-time diagram for timer

4.1.2 Automatic ON

With the **Automatic ON** function, the corresponding ON/OFF output is switched on during motion detection. To switch off this output again, an OFF command must be issued by another device, such as a push-button.

The delay time set on the device has no effect on the switching performance.

| Inputs | | | Outputs | |
|--------|-------------------------------|--|---------|--|
| | WST502 - 1 -2 <i>House</i> | | | TXA610 - - 1 -1 <i>House - lighting</i> |

Figure 12: Linking **Automatic ON** function

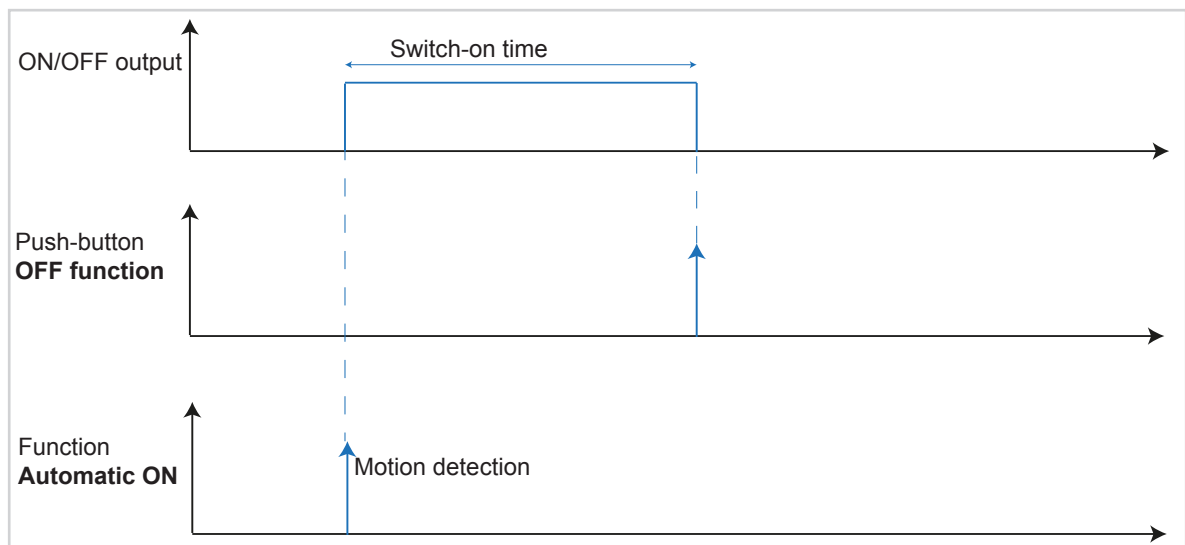

Figure 13: Signal-time diagram for **Automatic ON**

4.1.3 Automatic OFF

With the **Automatic OFF** function, the corresponding ON/OFF output is switched off during motion detection. To switch this output back on, an ON command must be issued by another device, such as a push-button.

The delay time set on the device has no effect on the switching performance.

| Inputs | | | Outputs | |
|--------|-------------------------------|--|---------|--|
| | WST502 - 1 -2 <i>House</i> | | | TXA610 - - 1 -1 <i>House - lighting</i> |

Figure 14: Linking **Automatic OFF** function

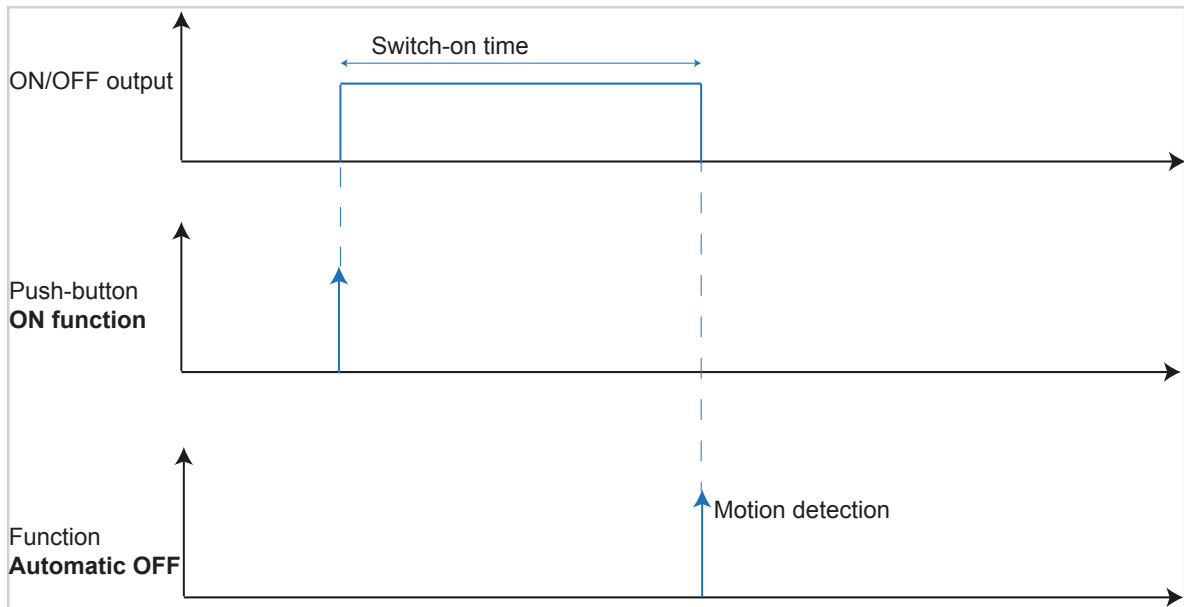

Figure 15: Signal-time diagram for **Automatic OFF**

4.1.4 Automatic control switching

With the **Automatic control switching** function, the corresponding ON/OFF output is switched on during motion detection for the time set on the device and switched off again once this time has elapsed.

| Inputs | | | Outputs | |
|--------|-------------------------------|--|---------|--|
| | WST502 - 1 -2 <i>House</i> | | | TXA610 - - 1 -1 <i>House - lighting</i> |

Figure 16: Linking **Automatic control switching** function

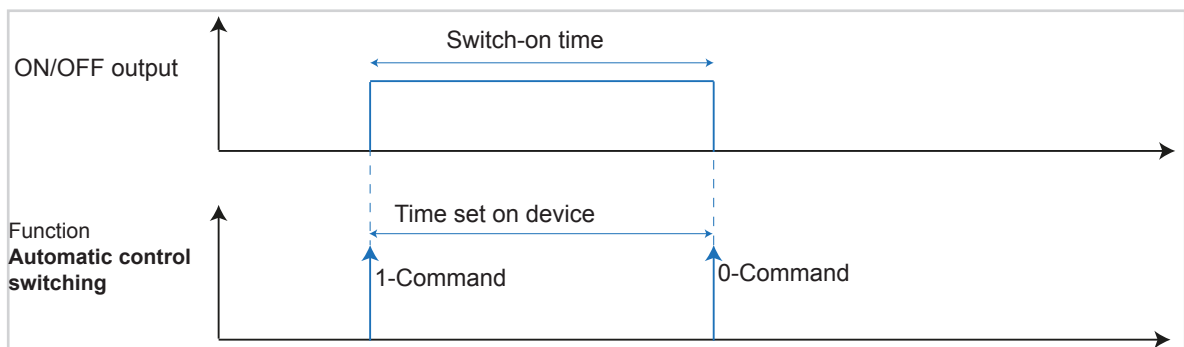

Figure 17: Signal-time diagram for **Automatic control switching**

4.1.5 Scene function

During motion detection, the scene set under Figure 19 is switched on. The device can call up a maximum of 8 scenes.

| Inputs | | | Outputs | |
|--------|------------------------------|--|---------|---|
| | WST502 - 1-2 <i>House</i> | | | TXA610 - - 1-1 <i>House - lighting</i> |

Figure 18: Linking **Scene** function

After selecting the Scene function, an additional menu field opens to determine the scene number. A scene between 1 - 8 can be entered here (Figure 19).

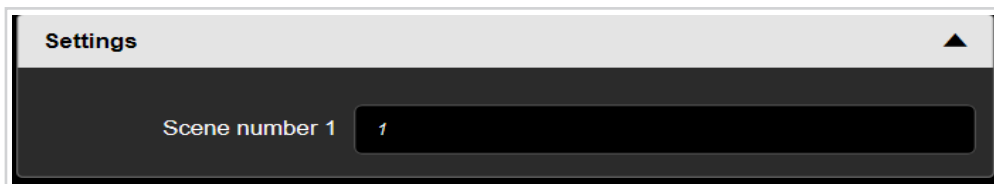

Figure 19: Entering the scene number

The related scene parameter values can be changed with the corresponding operating sections and stored with a long button press.

Example: Scene TV

In the Scene TV example, the typical scene values are changed and then the scene is saved again.

- These settings must be made on a push-button or on the corresponding actuators. The example shown here uses a 3gang push-button.
- The motion detector only switches to the selected scene.
- Switch on scene using a short press of the button (Figure 20, A).
Scene is activated e.g., lighting dimmed to 30%, blind closed to 85%.

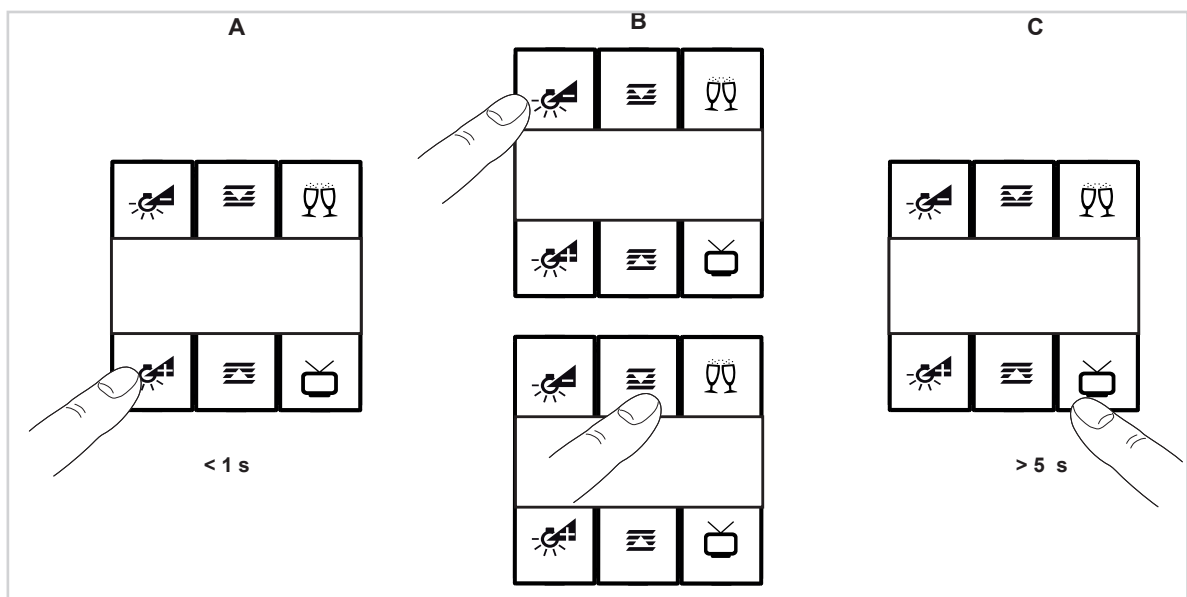

Figure 20: Scene call-up

Set new scene parameters on the push-button (Figure 20, B).

- Change lighting intensity, dim brighter or darker.
- Change blind position
- Hold the button for Scene TV for longer than 5 s (Figure 20, C).

New scene parameters have been saved. Pressing the button again activates the new scene settings.

The Save scene by a long key-press function is switched on by default.

4.1.6 Scene switching

During motion detection, the **Scene switching** function starts by activating switching to the scene set under **Scene number 1**. Once the delay time set in the motion detector has elapsed, a switch is made to the scene set under **Scene number 2**.

The Scene switching function can be applied to all function blocks (Lighting, Dimming, Roller shutter and Heating/cooling).

| Inputs | | | Outputs | |
|--------|------------------------|--|---------|---|
| | WST502 - 1 -2 House | | | TXA610 - - 1 -1 House - lighting |
| | | | | TXA661A - 1 -1 House - dimming |
| | | | | TXA610 - - 1 -1 House - roller shutter |
| | | | | WKT510 - 1 -1 House |

Figure 21: Linking **Scene switching** function

Settings ▲

Scene number 1

Scene number 2

Figure 22: Setting scene number 1 and 2

4.1.7 Overview of all possible linking combinations

The following overview shows all linking combination possibilities for the **Lighting** function. It is worth noting that inputs can also be linked with inputs (depending on the function selection).

| Linking | | | | |
|---------|--------------------------------|--|--------|------------------------------|
| Input | | | Output | |
| | WST502 - 1 -1 House | | | ON/OFF output |
| | | | | Dimming output |
| | WST502 - 1 -1 House | | | ON/OFF output |
| | | | | Dimming output |
| | WST502 - 1 -1 House | | | ON/OFF output |
| | | | | Dimming output |
| | WST502 - 1 -1 House | | | ON/OFF output |
| | | | | Dimming output |
| | WST502 - 1 -1 House (slave) | | | Additional detector (master) |
| | WST502 - 1 -1 House | | | Room thermostats |

Figure 23: Combination possibilities **Lighting** input – output

| Linking | | | | |
|---------|---------------------------------|--|-------|--------------------------------|
| Output | | | Input | |
| | WST502 - 1 -1 House | | | Automatic deactivation toggle |
| | | | | Deactivate automatic |
| | WST502 - 1 -1 House (master) | | | WST502 - 1 -4 House (slave) |

Figure 24: Combination possibilities, **Lighting** output - input

4.2 Dimming functions

With the **Dimming** function, the lighting is switched on at a set dimming value during motion detection.

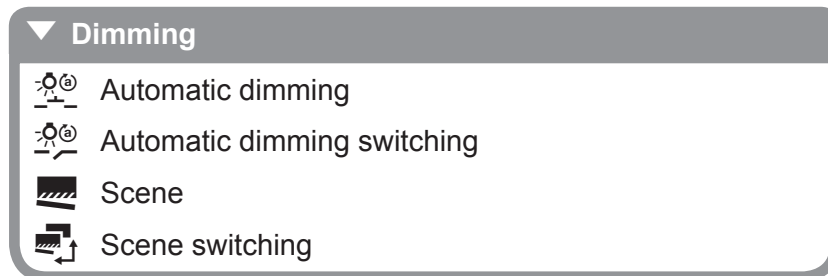

Figure 25: Functional overview **Dimming**

All functions from the **Lighting** function group can be linked with a dimming output. Only the relevant **switching commands** is executed.

4.2.1 Automatic dimming

With the **Automatic dimming** function, the lighting circuits/lighting is/are switched on at a previously set value, dimming value 1, during motion detection (Figure 26). The value to be set, dimming value 1, can be between 0 % (lighting OFF) ... 100 % (lighting ON). The lighting remains switched on until an OFF signal is issued by a push-button, for example.

- The time setting on the device itself is not evaluated.
- The set timer duration in the dimming output is not evaluated.

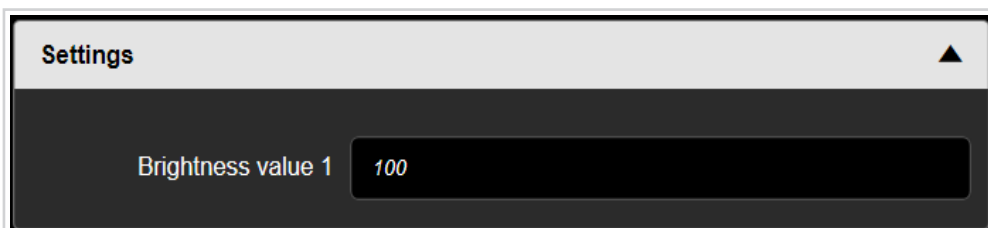

Figure 26: Dimming value setting 1 - **Automatic dimming**

| Inputs | | | Outputs | |
|--------|------------------------|--|---------|------------------------------------|
| | WST502 - 1 -1 House | | | TXA661A - 1 -1 House - lighting |

Figure 27: Linking **Automatic dimming** function

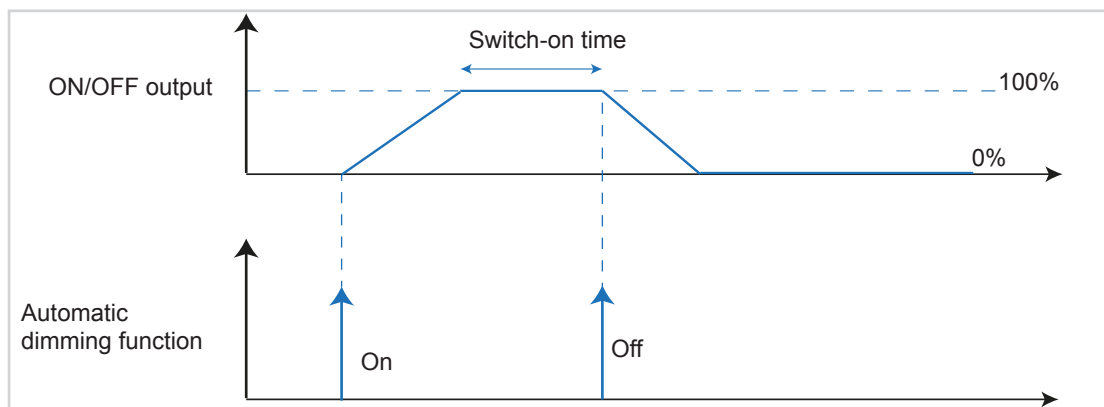

Figure 28: Signal-time diagram for **Automatic dimming**

4.2.2 Automatic dimming switching

With the **Automatic dimming switching** function, the lighting circuits/lighting is/are switched on at a previously set value, dimming value 1, during motion detection (Figure 29). Once the delay time set in the device has elapsed, a switch is made to the second value, dimming value 2. The values to be set, dimming values 1/2, can be between 0 % (lighting OFF) ... 100 % (lighting ON). The lighting remains switched on until an OFF signal is issued by a push-button, for example.

- The time setting on the device itself is not evaluated.
- The set timer duration in the dimming output is not evaluated either.

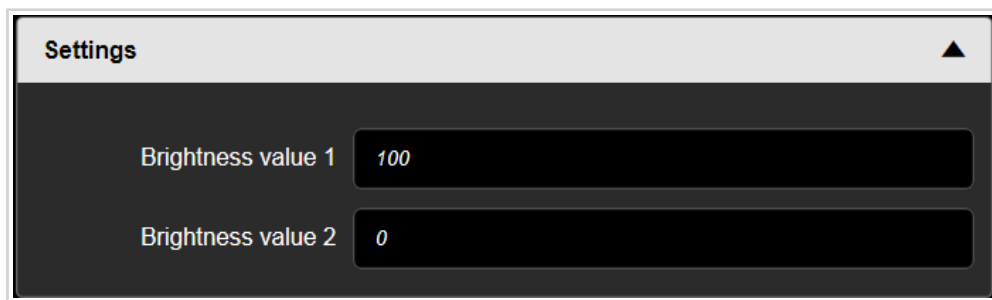

Figure 29: Dimming value setting 1/2 - **Automatic dimming switching**

| Inputs | | | Outputs | |
|--------|------------------------|--|---------|------------------------------------|
| | WST502 - 1 -1 House | | | TXA661A - 1 -1 House - lighting |

Figure 30: Linking **Automatic dimming switching** function

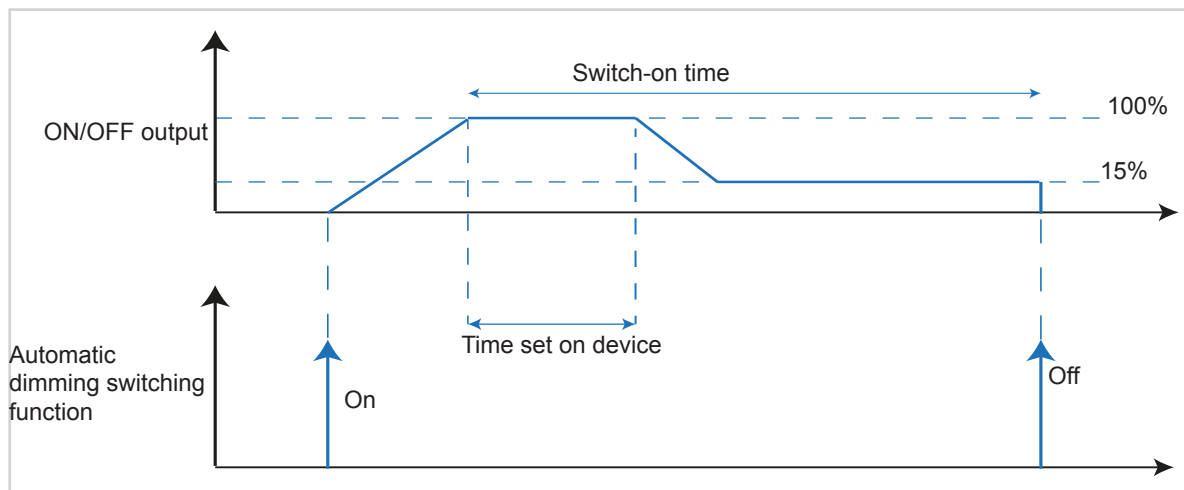

Figure 31: Signal-time diagram for **Automatic dimming switching**

4.2.3 Scene function

The precise description of the **Scene** function can be found in Chapter „4.1.5 Scene function “.

4.2.4 Scene switching function

The precise description of the **Scene switching** function can be found in Chapter „4.1.6 Scene switching “.

4.2.5 Overview of all possible linking combinations

The following overview shows all linking combination possibilities for the **Dimming** function. It is worth noting that inputs can also be linked with inputs (depending on the function selection).























| | | Linking | | |
|---|------------------------|---|--|----------------|
| Input  | | | Output  | |
|  | WST502 - 1 -1 House |  |  | ON/OFF output |
| | |  |  | Dimming output |
|  | WST502 - 1 -1 House |  |  | ON/OFF output |
| | |  |  | Dimming output |
|  | WST502 - 1 -1 House |  |  | ON/OFF output |
| | |  |  | Dimming output |
|  | WST502 - 1 -1 House |  |  | Dimming output |
| | |  |  | ON/OFF output |

Figure 32: Combination possibilities **Dimming** input – output

4.3 Roller shutter functions

The **Roller shutter** function for the detection channels is configured in the parameter windows below.

This function is used for activating roller shutters, blinds, awnings and other hangings.

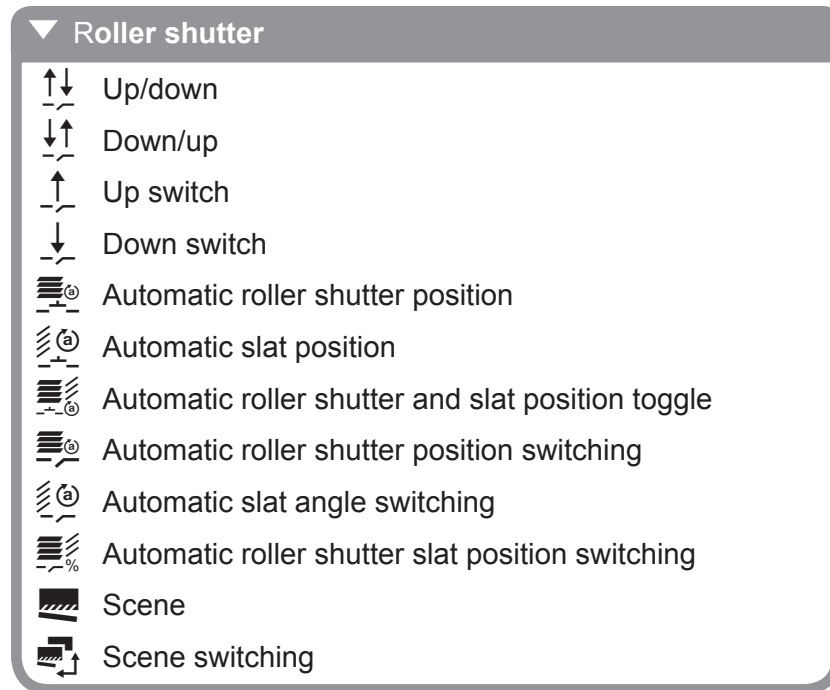



Figure 33: Functional overview **Roller shutter**

 For information on determining the operation time and the slat step time, see the operating instructions for the relevant switch actuator/blind actuator or roller shutter and blind actuator.

4.3.1 Basis roller shutter/blind control

In the case of roller shutter/blind drives with limit switches, the roller shutter/blind can be brought into the correct position by specifying a percentage value. The following settings are to be respected:

For blind drives, a distinction is also made between slats arranged horizontally and vertically.

Slat adjustment for slats arranged horizontally

The top final position of the roller shutters/blinds is set using the value 0 % and returned as a status value.

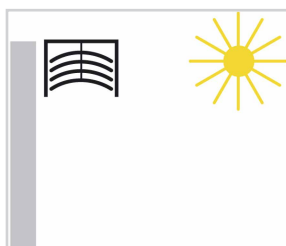

Function position in %

- Sun protection completely open
- Top final position reached: 0 %

Figure 34: Blind position top final position 0 %

The bottom final position of the roller shutters/blinds is set using the value 100 % and returned as a status value.

If a blind drive is moved from the top final position into the bottom final position, then the slats will initially tilt into a nearly vertical position and the blind will move with closed slats until it reaches the bottom final position.

If a blind is in the bottom final position and the slats are fully closed, then this slat position is identified as vertical and 100 %. However, the fully closed slats cannot be exactly vertical ($\alpha = 180^\circ$); instead, they are at a slight angle from the vertical.

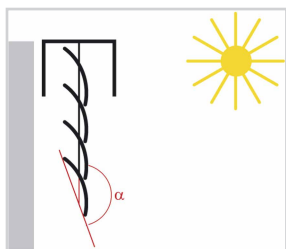

Function position in %

- Sun protection completely closed
- Top final position reached: 100 %

Figure 35: Blind position bottom final position

If the blind is set into motion from the vertical position (bottom end position, 100 % fully closed), the slats move into the horizontal position ($\alpha = 90^\circ$). With the Slat adjustment function, it is possible to determine the number of steps so that the slats can be adjusted almost infinitely.

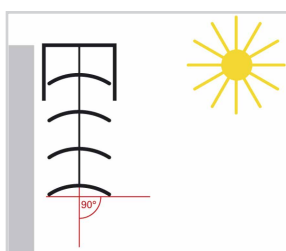

Slat angle in %

- Slat position horizontal ($\alpha = 90^\circ$)

Figure 36: Adjust slat angle

With blinds, the position of the slats can be adjusted beyond the horizontal position until they have reached the maximum point to which they can be adjusted and the blind starts moving towards the top final position. The slat angle can therefore adopt a value between 0 and 90° annehmen.

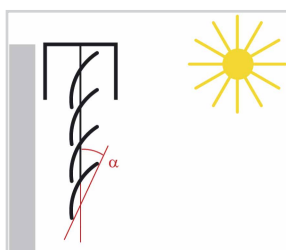

Slat angle in %

- Slat position at the start of the movement towards the top final position

Figure 37: Slat angle at the start of the movement towards the top final position

Slat adjustment for slats arranged vertically

When there is shade or screen with slats arranged vertically, the shade behaves like slats arranged horizontally. As a result, when the slats are fully open, the value 0 % is transmitted and returned as a status value. The slats therefore form an angle of $\alpha = 90^\circ$ the fully open shade to the fully closed shade.



Slat angle in %

- Fully open slats arranged vertically $\alpha = 90^\circ$

Figure 38: Slat angle for slats arranged vertically $\alpha = 90^\circ$

Fully closed slats are operated with a value of 100 %, which is also returned as a status. The angle which the slats form with the direction of travel is approximately 0° .

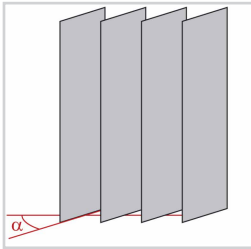

Slat angle in %

- Fully closed slats arranged vertically $\alpha \approx 0^\circ$

Figure 39: Slat angle for slats arranged vertically $\alpha \approx 0^\circ$

If the shade is open, the slats turn into a position at an angle a little less than 180° .

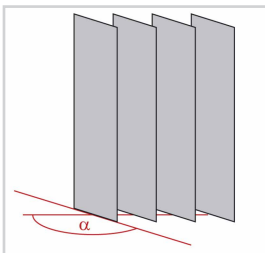

Slat angle in %

- Slats arranged vertically when opening $\alpha \approx 180^\circ$

Figure 40: Slat angle when opening $\alpha \approx 180^\circ$

4.3.2 Roller shutter up/down functions

With the **Roller shutter up/down** function, the roller shutter/blind output is switched on and moved into the top final position during motion detection. The operation time taken until the top final position is reached depends on the settings in the motion detector:

- The pulse encoder function is set on the device.
- A switching time is set on the device.

Pulse encoder function:

With the Pulse encoder function, the roller shutter/blind moves into the top final position during motion detection until the set running time has elapsed (ON/OFF output). Once the top final position is reached and the change-over time has elapsed, the roller shutter/blind moves into the bottom final position until the running time in the ON/OFF output has elapsed.

Switching time function:

With the Switching time function, the roller shutter/blind moves up during motion detection until the time set in the motion detector has elapsed. Once this time and the change-over time have elapsed, the roller shutter/blind moves into the bottom position until the running time set in the ON/OFF output has elapsed.

| Inputs | | | Outputs | |
|--------|-------------------------------|--|---------|--|
| | WST502 - 1 -1 <i>House</i> | | | TXA610 - - 1 -1 <i>House - roller shutter</i> |

Figure 41: Linking **Blind up/down** function

Further information on, for example, the operating mode or running time to the top/bottom final position can be found in the application description/operating instructions for the respective roller shutter/blind output.

4.3.3 Roller shutter down/up functions

With the **Roller shutter down/up** function, the roller shutter/blind output is switched on and moved into the bottom final position during motion detection. The operation time taken until the bottom final position is reached depends on the settings in the motion detector:

- The pulse encoder function is set on the device.
- A switching time is set on the device.

Pulse encoder function:

With the Pulse encoder function, the roller shutter/blind moves into the bottom final position during motion detection until the set running time has elapsed (ON/OFF output). Once the bottom final position is reached and the change-over time has elapsed, the roller shutter/blind moves into the top final position until the running time in the ON/OFF output has elapsed.

Switching time function:

With the Switching time function, the roller shutter/blind moves down during motion detection until the time set in the motion detector has elapsed. Once this time and the change-over time have elapsed, the roller shutter/blind moves into the top position until the running time set in the ON/OFF output has elapsed.

| Inputs | | | Outputs | |
|--------|-------------------------------|--|---------|--|
| | WST502 - 1 -1 <i>House</i> | | | TXA610 - - 1 -1 <i>House - roller shutter</i> |

Figure 42: Linking **Blind up/down** function

i Further information, e.g. operating mode, running time to top/bottom final position, can be found in the application description for the respective roller shutter/blind output.

4.3.4 Switching up function

The **Switching up** function causes the roller shutter/blind to move into the top final position during motion detection until the running time set in the roller shutter/blind output has elapsed.

| Inputs | | | Outputs | |
|--------|-------------------------------|--|---------|--|
| | WST502 - 1 -1 <i>House</i> | | | TXA610 - - 1 -1 <i>House - roller shutter</i> |

Figure 43: Linking **Blind up/down** function

4.3.5 Switching down function

The **Switching down** function causes the roller shutter/blind to move into the bottom final position during motion detection until the running time set in the roller shutter/blind output has elapsed.

| Inputs | | | Outputs | |
|--------|-------------------------------|--|---------|--|
| | WST502 - 1 -1 <i>House</i> | | | TXA610 - - 1 -1 <i>House - roller shutter</i> |

Figure 44: Linking **Blind up/down** function

4.3.6 Automatic roller shutter position function

The **Automatic roller shutter position** function moves the roller shutter into the set position during motion detection. The **Position 1** value in this case can be between 0 and 100 % (Figure 46).

- 0 %: top final position reached: 0 %, roller shutter/blind is open
- 100 %: bottom final position reached: 0 %, roller shutter/blind is closed

| Inputs | | | Outputs | |
|--------|-------------------------------|--|---------|--|
| | WST502 - 1 -2 <i>House</i> | | | TXA610 - - 1 -1 <i>House - roller shutter</i> |

Figure 45: Linking **Roller shutter position** function

Settings ▲

Position 1 (0-100%)

Figure 46: Entering the roller shutter position between 0 and 100 %

4.3.7 Automatic slat position function

During motion detection, the **slat position** rotates into the previously set position (Figure 48). The set value for **Slat angle 1** can be between 0 and 100 %.

- 0 %: slat fully opened, slat angle $\alpha = 90^\circ$
- 100 %: slat fully closed, slat angle $\alpha = 0^\circ$

| Inputs | | | Outputs | |
|--------|------------------------|--|---------|---|
| | WST502 - 1 -1 House | | | TXA610 - - 1 -1 House - roller shutter |

Figure 47: Linking **Slat angle** function

Settings ▲

Slat angle 1 (0-100%)

Figure 48: Entering the slat angle 0 - 100 %

4.3.8 Automatic roller shutter and slat position functions

During motion detection, the **roller shutter and slat position** rotates into the previously set position (Figure 50). The set value for **Slat angle 1** and **Position 1** can be between 0 and 100 %.

The roller shutter position is moved into the applicable position first, and the slat/slat angle is then adjusted.

- 0 %: slat fully opened, slat angle $\alpha = 90^\circ$
- 100 %: slat fully closed, slat angle $\alpha = 0^\circ$

| Inputs | | | Outputs | |
|--------|------------------------|--|---------|---|
| | WST502 - 1 -2 House | | | TXA610 - - 1 -1 House - roller shutter |

Figure 49: Linking **Roller shutter and slat position** function

Settings ▲

Slat angle 1 (0-100%)

Position 1 (0-100%)

Figure 50: Entering the position/slat angle 0 - 100 %

4.3.9 Automatic roller shutter position function

During motion detection, the **Automatic roller shutter position** function causes the roller shutter to move into the set **Position 1** (Figure 52). The delay time in the motion detector starts. Once the delay time has elapsed, **Position 2** (Figure 52) is approached and the roller shutter stops (Figure 53).

| Inputs | | | Outputs | |
|--------|-------------------------------|--|---------|--|
| | WST502 - 1 -1 <i>House</i> | | | TXA610 - - 1 -1 <i>House - roller shutter</i> |

Figure 51: Linking **Roller shutter and slat position** function

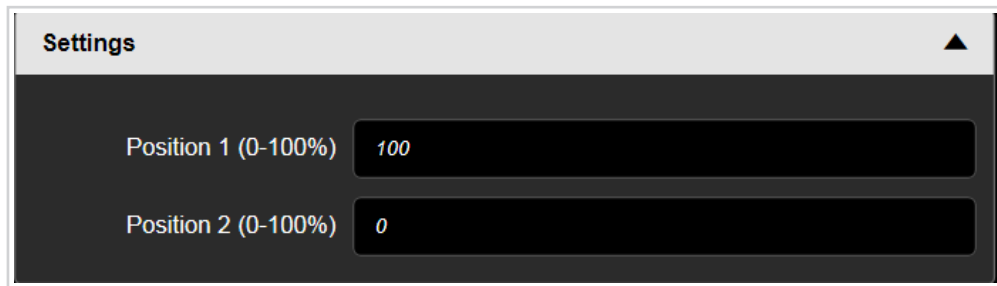

Figure 52: Entering **Position 1** and **Position 2**

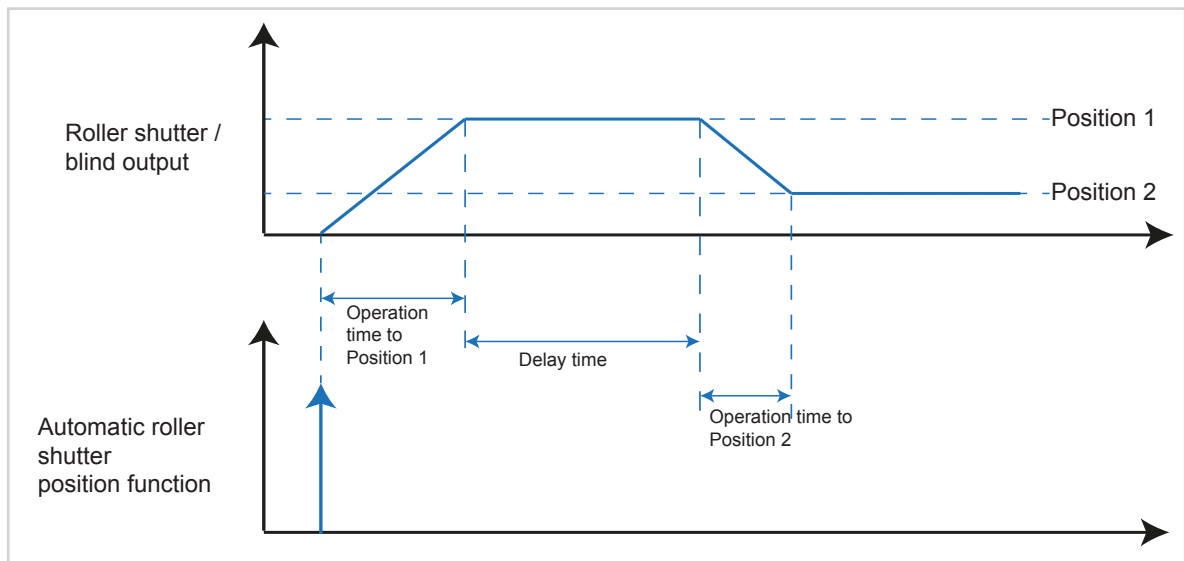

Figure 53: Signal-time diagram for **Automatic roller shutter position**

4.3.10 Automatic slat angle switching function

During motion detection, the **Automatic slat angle switching** function causes the slat angle to change to the **Slat angle 1** position (Figure 55). The delay time in the motion detector starts. Once the set delay time has elapsed, **Slat angle 2** (Figure 55) is set.

| Inputs | | | Outputs | |
|--------|-------------------------------|--|---------|--|
| | WST502 - 1 -2 <i>House</i> | | | TXA610 - - 1 -1 <i>House - roller shutter</i> |

Figure 54: Linking **Roller shutter and slat position** function

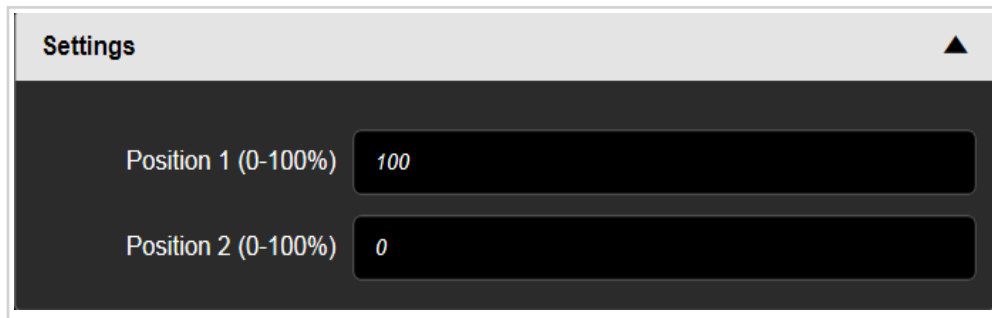

Figure 55: Entering **Slat angle 1** and **Slat angle 2**

4.3.11 Automatic roller shutter slat position switching function

With this function, the roller shutter/blind is moved into **Position 1/Slat angle 1** during motion detection. Once the delay time has elapsed, the roller shutter/blind moves into **Position 2/Slat angle 2**. The values for **Position X** and **Slat angle X** are between 0 and 100 % (Figure 57).

| Inputs | | | Outputs | |
|--------|------------------------|--|---------|---|
| | WST502 - 1 -1 House | | | TXA610 - - 1 -1 House - roller shutter |

Figure 56: Linking **Automatic roller shutter slat position switching** function

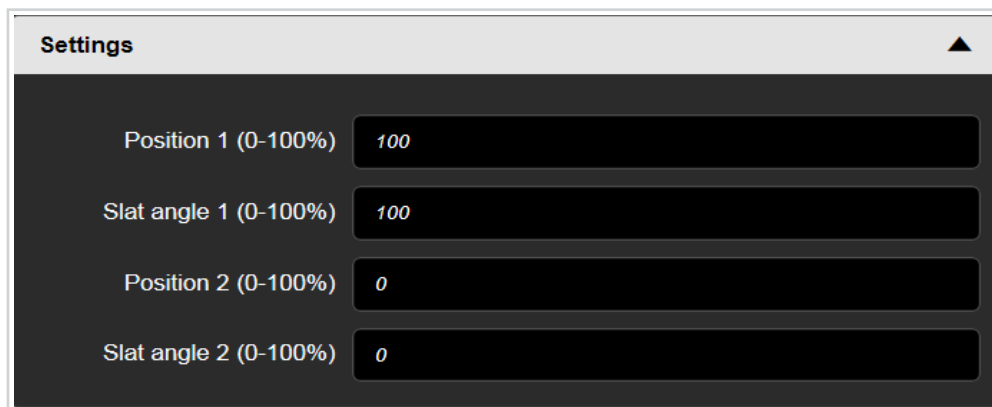

Figure 57: Entering **Position 1 and 2** and **Slat angle 1 and 2**

Further information, e.g. operating mode, running time to top/bottom final position, can be found in the settings for the respective roller shutter/blind output.

4.3.12 Scene function

The precise description of the **Scene** function can be found in Chapter „4.1.5 Scene function “.

4.3.13 Scene switching function

The precise description of the **Scene switching** function can be found in Chapter „4.1.6 Scene switching “.

4.3.14 Overview of all possible linking combinations

The following overview shows all linking combination possibilities for the **Roller shutter** function.

| Linking | | | | |
|---------|------------------------|--|--------|-----------------------------|
| Input | | | Output | |
| | WST502 - 1 -1 House | | | Output roller shutter/blind |
| | WST502 - 1 -1 House | | | Output roller shutter/blind |
| | WST502 - 1 -1 House | | | Output roller shutter/blind |
| | WST502 - 1 -1 House | | | Output roller shutter/blind |
| | WST502 - 1 -1 House | | | Output roller shutter/blind |
| | WST502 - 1 -1 House | | | Output roller shutter/blind |
| | WST502 - 1 -1 House | | | Output roller shutter/blind |
| | WST502 - 1 -1 House | | | Output roller shutter/blind |
| | WST502 - 1 -1 House | | | Output roller shutter/blind |
| | WST502 - 1 -1 House | | | Output roller shutter/blind |
| | WST502 - 1 -1 House | | | Output roller shutter/blind |
| | WST502 - 1 -1 House | | | Output roller shutter/blind |

Figure 58: Combination possibilities **Roller shutter** input – output

4.4 Heating/cooling functions

The **Heating/cooling** function allows an external KNX room thermostat to be activated during motion detection.

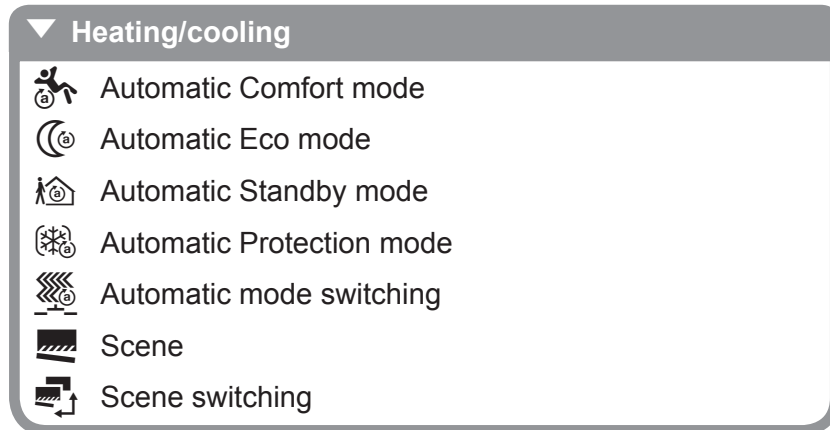





Figure 59: Functional overview **Heating/cooling**

With the Comfort, Eco, Standby and Protection mode functions, the corresponding operating modes can be switched on in the associated thermostats during motion detection or changed and transmitted to the bus.

Example:

- Comfort 

The **Comfort** operating mode sets the room temperature to a temperature value predefined in the thermostat (e.g. comfort temperature 21°C) for comfort (presence).
- Standby 

The **Standby** operating mode reduces the room temperature after leaving the room (brief absence) to a value predefined in the thermostat (19°C, for example).
- Eco 

The **Eco** operating mode turns down the room temperature during holiday time (during long absence) to a value of 17°C defined in the thermostat.
- Frost protection 

The **Protection** operating mode reduces the heating circuit temperature to a minimum temperature of 7°C defined in the controller to protect against frost damage over night or during periods of extended absence.

 With underfloor heating, the change-over from "Comfort" to Standby is only noticeable after a certain period of time due to the sluggishness of the underfloor heating system.

4.4.1 Automatic Comfort mode function

During motion detection, the device switches the operating mode set in the room thermostat to Comfort mode. The Comfort mode parameters set in the room thermostat are switched on (comfort temperature 21°C, for example).



| Inputs | | | Outputs | |
|---|--------------------------------|---|--|--|
|  | WST502 - 1 - 2 <i>House</i> |  |  | WKT510 - 1 - 1 <i>House - Heating/cooling</i> |

Figure 60: Linking **Comfort mode** function

4.4.2 Automatic Standby mode function

During motion detection, the device switches the operating mode set in the room thermostat to Standby mode. The Standby mode parameters set in the room thermostat are switched on (19°C, for example).



| Inputs | | | Outputs | |
|---|-------------------------------|---|--|--|
|  | WST502 - 1 -2 <i>House</i> |  |  | WKT510 - 1 - 1 <i>House - Heating/cooling</i> |

Figure 61: Linking **Standby mode** function

4.4.3 Automatic Eco mode function

During motion detection, the device switches the operating mode set in the room thermostat to Eco mode. The Eco mode parameters set in the room thermostat are switched on (17°C, for example).



| Inputs | | | Outputs | |
|---|-------------------------------|---|--|--|
|  | WST502 - 1 -2 <i>House</i> |  |  | WKT510 - 1 - 1 <i>House - Heating/cooling</i> |

Figure 62: Linking **Eco mode** function

4.4.4 Automatic Protection mode function

During motion detection, the device switches the operating mode set in the room thermostat to Protection mode. The Protection mode parameters set in the room thermostat are switched on (7°C, for example).



| Inputs | | | Outputs | |
|---|-------------------------------|---|--|--|
|  | WST502 - 1 -2 <i>House</i> |  |  | WKT510 - 1 - 1 <i>House - Heating/cooling</i> |

Figure 63: Linking **Protection mode** function

4.4.5 Automatic mode switching function

With the **Automatic mode switching** function, the operating mode for the **Heating - Cooling mode 1** value is switched on first during motion detection; once the delay time set in the PIR has elapsed, a switch is then made to the second operating mode for the **Heating - Cooling mode 2** value.

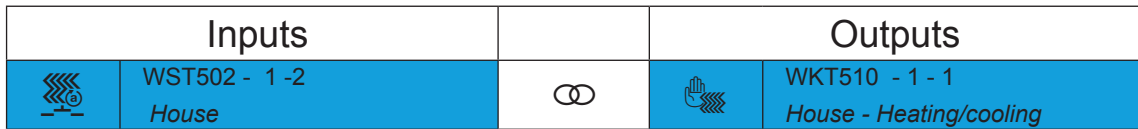

Figure 64: Linking **Setpoint offset** function

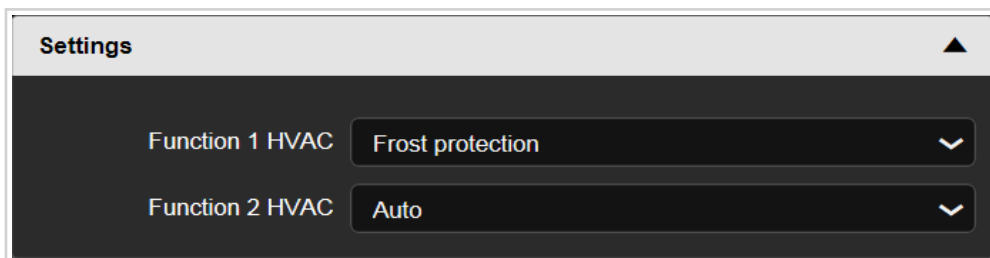



Figure 65: **Setpoint offset** settings

| Parameters | Description | Value |
|--------------------------|---|--|
| Heating - Cooling mode 1 | This parameter is used to set the operating mode for the Heating - Cooling mode 1 value. | Auto Comfort * Standby Night setpoint Frost protection |
| Heating - Cooling mode 2 | This parameter is used to set the operating mode for the Heating - Cooling mode 2 value. | Auto * Comfort Standby Night setpoint Frost protection |

Figure 66: **Automatic mode switching** parameters

4.4.6 Scene function

The precise description of the **Scene** function can be found in Chapter „4.1.5 Scene function “.

4.4.7 Scene switching function

The precise description of the **Scene switching** function can be found in Chapter „4.1.6 Scene switching “.

4.4.8 Overview of all possible linking combinations

The following overview shows all linking combination possibilities for the **Heating/cooling** function.











| Linking | | | |
|---|---------------------------|---|---|
| Input ↔ | | | Input ↔ |
|  | Automatic Comfort mode |  |  WKT510 - 1 -1 House |
|  | Automatic Eco mode | | |
|  | Automatic Standby mode | | |
|  | Automatic Protection mode | | |
|  | Automatic mode switching | | |
|  | Scene | | |
|  | Scene switching | | |

Figure 67: Linking input – input **Heating/cooling**

5. Master-slave application

The master-slave application requires one master device and at least one slave device to be installed in the system. Any number of slave devices can be connected to a master device. Only the master device sends switching, dimming value, blind, light scene, and heating/cooling telegrams, and controls the load.

The devices communicate with one another by means of the  function. If the main unit directly detects a motion, it sends the parameterised telegram when detection begins and sends a motion telegram to the bus in order to inform the slave device about the motion. The master device takes into account the locally set dusk level.

If the slave device detects a motion, it sends a value = 1 to the master device cyclically for the duration of the motion, taking into account the dusk level set locally on the slave device. In turn, the master device cyclically checks whether motion messages have been received.

Two different cases may apply:

- The dusk level is evaluated in the master device and the slave device
If the master device receives a motion telegram from the slave, the master starts motion evaluation and transfers the telegram when detection begins, regardless of the dusk level set in the master device.
- The dusk level is only evaluated in the master device
If the master device receives a motion telegram from the slave, the master starts by checking the dusk level set in it. Once the ambient brightness drops below the value set in the master device, the master device starts motion evaluation and sends the telegram when detection begins.

If the master itself no longer detects any motions or no longer receives any motion telegrams from the slave, the master ends motion evaluation and issues the telegram when detection ends.

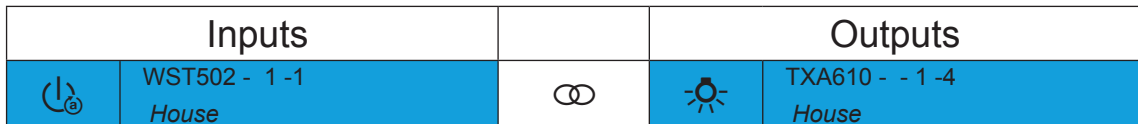

Figure 68: Master - actuator output linking

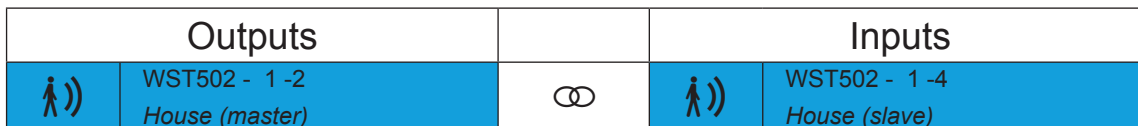

Figure 69: Linking **Master-slave** function

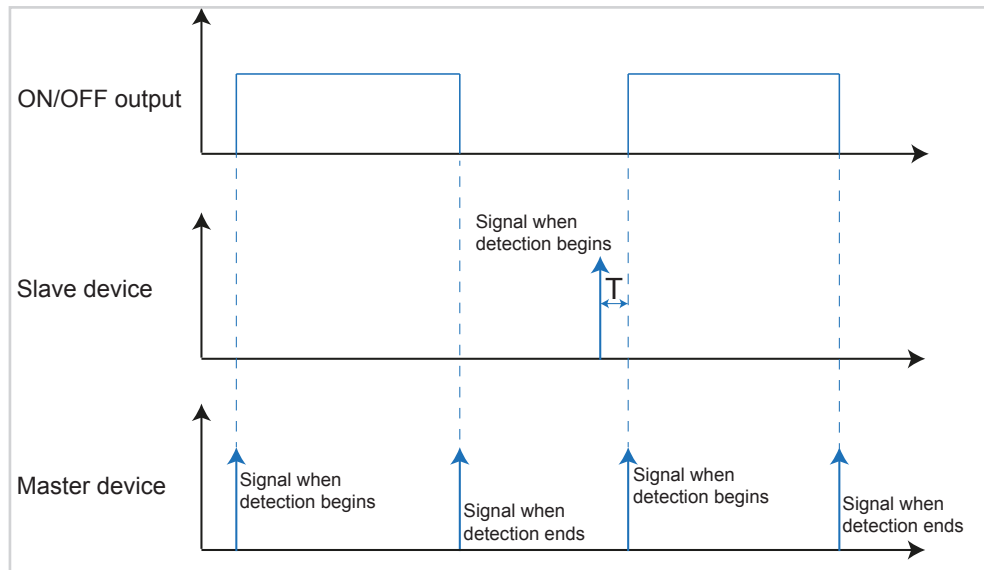

Figure 70: Signal-time diagram for master-slave application



T : Delay time between detecting a motion on the slave device and processing the signal in the master device and forwarding to the actuator output.

- i** The signal-time diagram shown here represents an example of a master-slave application. The brightness is below the set brightness value.

6. Internal temperature sensor

The device is directly fitted with a sensor for temperature measurement.

The measured temperature is not processed directly in the motion detector, but instead sent to a KNX thermostat, where it is processed by the appropriately set parameters and sent on.

-  The measured air can be transmitted directly to a KNX thermostat as a second measuring point (measurement result) and can be used to synchronise the global actual temperature (synchronisation in larger rooms).
-  Room temperature recorded as a measurement result for a building visualisation



| Inputs | | | Inputs | |
|---|------------------------|---|--|------------------------|
|  | WST502 - 1 -9 House |  |  | WKT510 - 1 -1 House |

Figure 71: Linking input – input **Internal temperature sensor** function

7. Appendix

7.1 Technical data - performances

| | |
|-------------------------------|-----------------------------|
| KNX medium | TP 1 |
| Configuration mode | easy link |
| Rated voltage KNX | 21 ... 32 V _{SELV} |
| Current consumption KNX | max. 10 mA |
| Connection mode KNX | bus connecting terminal |
| Response brightness | approx. 5 ... 1000 lux (∞) |
| Delay time | approx. 10 s ... 30 min |
| Detection angle | approx. 90 ... 180° |
| Detection area (1.1 m) | approx. 12 x 16 m |
| Degree of protection | IP20 |
| Ambient temperature | -5 ... +45°C |
| Storage/transport temperature | -20 ... +70 °C |

8. Table of Figures

| | |
|---|----|
| Figure 1: Device overview | 5 |
| Figure 2: Input/output signals Lighting function | 8 |
| Figure 3: Input/output signals Dimming function | 9 |
| Figure 4: Input/output signals Roller shutter function | 11 |
| Figure 5: Input/output signals Heating/cooling function..... | 12 |
| Figure 6: Device information..... | 14 |
| Figure 7: Setting the detection angle..... | 15 |
| Figure 8: Function selection of the independent push-button | 18 |
| Figure 9: Functional overview lighting | 19 |
| Figure 10: Linking Timer function..... | 19 |
| Figure 11: Signal-time diagram for timer | 19 |
| Figure 12: Linking Automatic ON function | 20 |
| Figure 13: Signal-time diagram for Automatic ON | 20 |
| Figure 14: Linking Automatic OFF function..... | 21 |
| Figure 15: Signal-time diagram for Automatic OFF | 21 |
| Figure 16: Linking Automatic control switching function..... | 21 |
| Figure 17: Signal-time diagram for Automatic control switching | 21 |
| Figure 18: Linking Scene function..... | 22 |
| Figure 19: Entering the scene number | 22 |
| Figure 20: Scene call-up..... | 22 |
| Figure 21: Linking Scene switching function | 23 |
| Figure 22: Setting scene number 1 and 2 | 23 |
| Figure 23: Combination possibilities Lighting input – output..... | 24 |
| Figure 24: Combination possibilities, Lighting output - input..... | 24 |
| Figure 25: Functional overview Dimming | 25 |
| Figure 26: Dimming value setting 1 - Automatic dimming | 25 |
| Figure 27: Linking Automatic dimming function..... | 25 |
| Figure 28: Signal-time diagram for Automatic dimming | 25 |
| Figure 29: Dimming value setting 1/2 - Automatic dimming switching | 26 |
| Figure 30: Linking Automatic dimming switching function | 26 |
| Figure 31: Signal-time diagram for Automatic dimming switching | 26 |
| Figure 32: Combination possibilities Dimming input – output..... | 27 |
| Figure 33: Functional overview Roller shutter | 28 |
| Figure 34: Blind position top final position 0 %..... | 28 |
| Figure 35: Blind position bottom final position | 29 |
| Figure 36: Adjust slat angle | 29 |
| Figure 37: Slat angle at the start of the movement towards the top final position | 29 |
| Figure 38: Slat angle for slats arranged vertically $\alpha = 90^\circ$ | 30 |
| Figure 39: Slat angle for slats arranged vertically $\alpha \approx 0^\circ$ | 30 |
| Figure 40: Slat angle when opening $\alpha \approx 180^\circ$ | 30 |
| Figure 41: Linking Blind up/down function..... | 31 |
| Figure 42: Linking Blind up/down function..... | 31 |
| Figure 43: Linking Blind up/down function..... | 32 |
| Figure 44: Linking Blind up/down function..... | 32 |

| | |
|---|----|
| Figure 45: Linking Roller shutter position function | 32 |
| Figure 46: Entering the roller shutter position between 0 and 100 % | 32 |
| Figure 47: Linking Slat angle function | 33 |
| Figure 48: Entering the slat angle 0 - 100 % | 33 |
| Figure 49: Linking Roller shutter and slat position function | 33 |
| Figure 50: Entering the position/slat angle 0 - 100 % | 33 |
| Figure 51: Linking Roller shutter and slat position function | 34 |
| Figure 52: Entering Position 1 and Position 2 | 34 |
| Figure 53: Signal-time diagram for Automatic roller shutter position | 34 |
| Figure 54: Linking Roller shutter and slat position function | 34 |
| Figure 55: Entering Slat angle 1 and Slat angle 2 | 35 |
| Figure 56: Linking Automatic roller shutter slat position switching function | 35 |
| Figure 57: Entering Position 1 and 2 and Slat angle 1 and 2 | 35 |
| Figure 58: Combination possibilities Roller shutter input – output | 36 |
| Figure 59: Functional overview Heating/cooling | 37 |
| Figure 60: Linking Comfort mode function | 37 |
| Figure 61: Linking Standby mode function | 38 |
| Figure 62: Linking Eco mode function | 38 |
| Figure 63: Linking Protection mode function | 38 |
| Figure 64: Linking Setpoint offset function | 39 |
| Figure 65: Setpoint offset settings | 39 |
| Figure 66: Automatic mode switching parameters | 39 |
| Figure 67: Linking input – input Heating/cooling | 40 |
| Figure 68: Master - actuator output linking | 41 |
| Figure 69: Linking Master-slave function | 41 |
| Figure 70: Signal-time diagram for master-slave application | 42 |
| Figure 71: Linking input – input Internal temperature sensor function | 43 |

9. List of tables

| | |
|--|----|
| Table 1: Activating/deactivating the detection area | 14 |
| Table 2: Setting the detection area parameters | 14 |
| Table 3: Setting the application..... | 15 |
| Table 4: Selecting the device application..... | 15 |
| Table 5: Overview of inputs/outputs - individual application | 16 |
| Table 6: Overview of inputs/outputs - master | 17 |
| Table 7: Overview of inputs/outputs - slave | 17 |
| Table 8: Function during motion detection..... | 18 |

Ⓓ Hager Vertriebsgesellschaft mbH & Co. KG
Zum Gunterstal
D-66440 Blieskastel
<http://www.hagergroup.de>
Tel.: 0049 (0)1 83/3 23 23 28

Ⓐ Hager Electro GesmbH
Dieselgasse 3
A-2333 Leopoldsdorf
www.hagergroup.at
Tel.: 0043 (0)2235/44 600

Ⓒ Hager AG
Sedelstrasse 2
6021 Emmenbrücke
<http://www.hager.ch>
Tel.: +41 (0)41 269 90 00