

WYW51xQ  
WYW52xQ

Safety instructions

Electrical equipment must only be installed and assembled by a qualified electrician in accordance with the relevant installation standards, regulations, directives and safety and accident prevention directives of the country.

Failure to comply with these instructions may result in damage to the device, fire or other hazards.

The radio transmission is not suitable for safety or alarm applications.

Due to its detection behaviour the device is not suitable for use in burglary detection or alarm systems.

These instructions are an integral component of the product and must be retained by the end user.

Design of the device

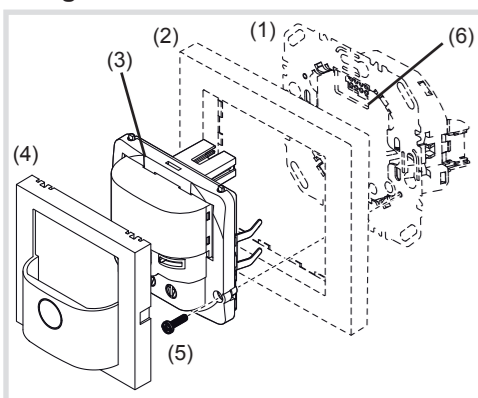

Figure 1: Design of the device

- (1) Insert (see „Accessories“, not in scope of delivery)
- (2) Frame (not in scope of delivery)
- (3) Application module
- (4) Motion detector design cover
- (5) Screw for dismantling protection
- (6) Interface between application and power module insert/application module

Function

System information

This device is a product of the quicklink system, in which installation devices communicate via radio signals.

quicklink stands for a configuration mode in which the function-related connection between transmitters and receivers is set on the device via push-buttons and displays without further tools.

All devices configurable via quicklink can be operated together in one system.

Radio motion detector comfort  
1.1 m/2.2 m quicklink

This device is compliant to the R&TTE-Directive 1999/5/EG. The Declaration of Conformity and further system information can be found on our homepage www.berker.de.

The device may be used in all EU and EFTA countries.

Correct use

- Automatic switching of lighting depending on heat motion and ambient brightness
- Application module for switch insert, flush-mounted dimmer or power supply for radio application modules
- The device has been laid out for smaller applications in which a maximum of 20 devices are allocated
- Only suitable for use in indoor areas, no drip or spray water

Product characteristics

- quicklink functions to extend the detection area, scenes, control circuits
- Remote control via quicklink transmitter
- Integrated button for selecting operating modes and special functions
- Lockable integrated button
- Operating modes - automatic mode, permanent ON, permanent OFF can be selected
- Indication of operating modes via LED
- Potentiometer for adjusting the response brightness and detection sensitivity
- Adjustable detection angle for adaptation of the detection area
- Additional adjustment of the response brightness via Teach-In function
- Party function
- Presence simulation
- Optional extension unit operation via installation button

Automatic mode

The motion detector detects heat motion caused by persons, animals, or objects.

On switch insert and flush-mounted dimmer with factory setting:

- The light will be switched on for a fixed delay time of 3 minutes if movements are detected in the detection area and the set brightness threshold is undershot. Each additional movement in the detection area restarts the delay time.
- The light will be switched off after 3 minutes if no additional movements are detected.

On flush-mounted dimmer configured with time function (see radio configuration quicklink):

- The light will be switched on for the delay time, if movements are detected in the detection area and the set brightness threshold is undershot. Each additional movement in the detection area restarts the delay time.
- After the delay time elapses the lighting will be dimmed to 50% of the switch-on brightness-level and will remain at this brightness level for 30 s (switch-off pre-warning). Each movement detected during the switch-off pre-warning restarts the delay time and restores the switch-on brightness level.
- The light will be switched off if no motion is detected any longer in the detection area and the set delay time and the switch-off time have elapsed.

Performance after mains breakdown/return of mains supply

- Mains breakdown shorter than 0.2 s: The function is not impaired.
- Mains breakdown longer than 0.2 s: There is no function during the mains breakdown. The current configuration is saved in non-volatile memory.
- Return of mains supply: The application module executes an initialisation for approx. 5 s, during which the lighting will be switched on. Motion detection starts thereafter. If no motion is detected during the first 5 s, the lighting is switched off. The stored configuration is loaded from memory. During this period local operation via the button or extension unit can be used.

Operation

Operating concept

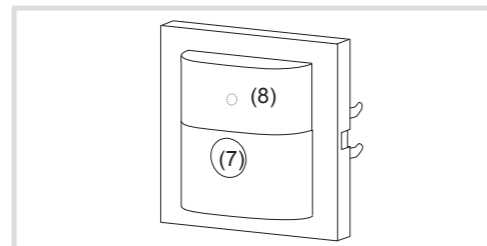

Fig. 2: Operating and display elements

- (7) Button
- (8) Status LED

Operation is executed by pushing the button (7) on the motion detector:

- A short press of the button switches the operating modes. The operating mode is displayed via the status LED behind the optics cover of the motion detector.
- Keeping the button pressed activates special functions. Selection of the special functions is supported by the LED display (Fig. 3).

Selecting the operating mode

- Repeated short press on button until the desired operating mode is selected. The status LED indicates the selected operating mode (see Table 1).

Switching the operating mode finishes the party function or presence simulation, if these functions were previously active.

Disabling/enabling operating mode selection via button

- Keep the button pressed for more than 15 seconds, until the status LED is flashing green (Fig. 3). Selection of the operating mode via the button is disabled.
- or if the button is disabled:
  - Keep the button pressed for more than 15 seconds, until the status LED is flashing green (Fig. 3). Selection of the operating mode via the button is possible again.

Switch on the lighting via push-button extension unit or change the switch-on brightness-level

Optionally the lighting can be switched on via a mechanical push-button extension unit (Table 2).

For extension unit operation, the lighting is switched on independently of the set brightness threshold.

When using the flush-mounted dimmers, the last set brightness level will be saved as the switch-on brightness-level.

Activating/interrupting party function

The party function switches the lighting on for 2 hours. During this time no extension unit or radio commands are executed.

- Keep the button pressed for more than 5 seconds, until the status LED is flashing red (Fig. 3). The lighting is switched on for 2 hours. During this time the status LED is flashing red. Upon elapse of 2 hours, the motion detector switches to **Auto** operation mode.
- Short press on button. The party function will be interrupted, the motion detector returns to **Auto** mode.

Setting response brightness via Teach-In function

The response brightness is the brightness value saved in the motion detector; when this value is undershot the motion detector switches the connected load if movements are detected. Via Teach-In function the current ambient brightness is saved as the response brightness.

The load is switched off.

- Keep the button pressed for more than 10 seconds, until the status LED is flashing orange (Fig. 3).

The motion detector detects the current ambient brightness and saves it as response brightness. Setting of the response brightness via Teach-In function and via the brightness potentiometer has the same priority. Teach-In overwrites the response brightness set on the brightness potentiometer. If the setting is made again via the potentiometer the Teach-In figure will be overwritten.

Activating/deactivating presence simulation

During operation, the motion detector counts the motion detections in one full hour and saves the result. With active presence simulation at the beginning of the hour with the most detections saved, the light will be switched on for the duration of the delay time, even no motion is detected.

During the presence simulation presence detection, extension unit and radio commands will continue to be executed normally.

- Keep the button pressed for more than 20 seconds, until the status LED is slowly flashing red (Fig. 3).

The presence simulation is active. During this time the status LED lights orange. The motion detector switches the lighting on at the saved time.

- Short press on button.

The presence simulation will be disabled, the motion detector returns to **Auto** mode.

Setting the load

If the dimming and switching performance of loads is unsatisfactory after start-up, especially when circuited to energy-saving lamps and 230 V LED lamps, a load setting must be carried out for universal switch inserts or universal touch dimmers.

Function	Party function	Teach-In	Keylock	Presence simulation	Load setting-mode <sup>1)</sup>
LED display	[Red]	[Orange]	[Green]	[Red]	[Orange]
Hold time button	> 5 s	>10 s	> 15 s	> 20 s	> 25 s

<sup>1)</sup> Only on universal switch insert and universal flush-mounted dimmer

Fig. 3: Selection of the special functions and LED display

LED display	Operating mode	Description
--	Auto	Motion-dependent and brightness-dependent switch on/switch off of the load
green	Permanent ON	Load is permanently switched-on/switched-off.
red	Permanent OFF	Extension unit signals, as well as radio signals, will not be evaluated

Table 1: Display of operating modes

Dimming status	Operation button	Performance of the insert
Motion detector applied on switch insert		
OFF	Short press	Load is switched on for the set delay time
ON	Short press	Extension of switch-on time by the set delay time
Motion detector applied on flush-mounted dimmer		
OFF	Short press	Load is switched on to the switch-on brightness-level for the set delay time
ON	Short press	Extension of switch-on time by the set delay time at the same brightness
OFF	Long press	Load is switched on to switch-on brightness-level, subsequent dimming in the opposite direction of the last dimming process. Thereafter the load remains switched on for the delay time
ON	Long press	Changes the current brightness. Dimming takes place in the opposite direction of the last dimming process until maximum or minimum brightness. Subsequently the load remains switched on at the set brightness for the set delay time

Table 2: Operation via push-button extension unit

Short press on button	Setting mode	Confirmation of the load setting	Notes
1 x	Load fine-setting	Load blinks 1 x after approx. 30 s and changes to switching/dimming operation	Not suitable for ohmic loads (e.g. incandescent, HV halogen lamps); use factory load setting. If the load fine-setting does not bring any improvement for energy-saving lamps or 230 V LED lamps, select the energy-saving lamp fine-setting or 230 V LED lamp universal setting.
2 x	Factory load setting	Load blinks 2 x after approx. 6 s and changes to switching/dimming operation	
3 x	Energy-saving lamp fine-setting in phase cut-on	Load blinks 3 x after approx. 30 s and changes to switching/dimming operation	Energy-saving lamps are switched ON at a brightness level of at least 50% brightness in order to ensure an ignition process.
<b>Universal touch dimmer up to version R0.x</b>			
4 x	230 V LED lamp universal setting in phase cut-on	Load blinks 4 x after approx. 5 s and changes to switching/dimming operation	The universal setting contains standard values which enable the operation of typical dimmable 230 V LED lamps.
<b>Universal touch dimmer from version R1.1</b>			
4 x	230 V LED lamp universal setting in phase cut-on or phase cut-off	Load blinks 4 x after approx. 5 s and changes to normal operation	The dimming principle and optimal switch-on brightness for the connected dimmable 230 V LED lamps are set automatically.
	For all setting modes	Load blinks 5 x	The selected setting mode is not supported by the insert.

Table 3: Load setting mode

Information for electricians

Installation and electrical connection

Selecting installation location

A minimum distance between the transmitter and corresponding receiver of about 1 m must be maintained.

A minimum distance to electronic devices which emit high frequency signals such as computers, electronic transformers or microwave devices of approx. 0.5 m must be maintained.

Mounting on or close to metal surfaces may cause impairment of the radio transmission.

Take material penetration into account. The range of the system can be optimised by selecting the best possible mounting location:

Material	Degree of material penetration
Wood, plaster, plaster-board, uncoated glass	ca. 90 %
Brick, press boards	ca. 70 %
Reinforced concrete, floor heating	ca. 30 %
Metal, metal grids, aluminium laminates, coated glass	ca. 10 %
Rain, snow	ca. 1 ... 40 %

Table 4: Material penetration

Observe the motion orientation: a distinction is made between direct approach and transverse motion. Motions transverse to the motion detector can be detected better than motions toward the motion detector (Fig. 4).

- Select a installation location that is free of vibration. Vibrations can cause undesired switching.
- Avoid sources of interference in the detection area (Figure 6/7). Sources of interference, e.g. heating elements, ventilation systems, air conditioners and illuminants that are cooling down can cause undesired switching (Fig. 4).

To avoid disturbing influences, the detection angle can be restricted (see Restriction of the detection area).

Assembly of the device (Figure 1)

Information on electrical connection are to be taken from the operating instruction of for the insert.

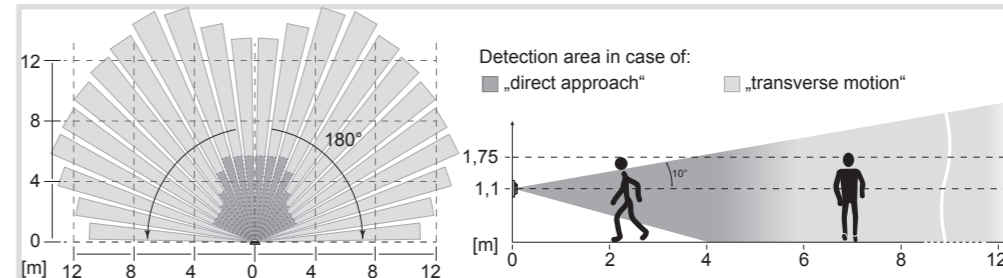

Fig 6: Detection area of the radio motion detector 1,1 m

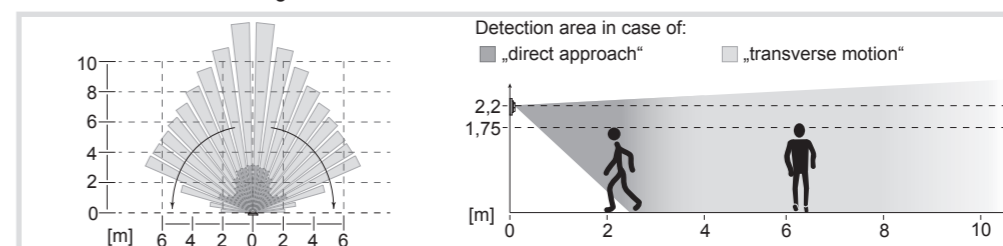

Fig 7: Detection area of the radio motion detector 2,2 m

- Attach the bottom part of the application module (3) together with frame (2) to a suitable insert (1) and establish a connection between insert and the application module via the interface between application and power module (6). As soon as voltage is supplied to the application module, the status LED indicates the compatibility to the insert used.

Status LED display	Meaning
LED blinks green (approx. 5 s until motion detection is active)	Compatible
LED blinks red for 5 s	Not compatible.
LED blinks orange for 5 s	Compatible, but not configured to each other. For a new configuration, the application module must be reset to factory settings.

- If available, fix dismantling protection with screw (5).
- After radio configuration and start-up, click the design cover (4) into place on the application module (3).

Start-up

Overview of operation and adjustment elements

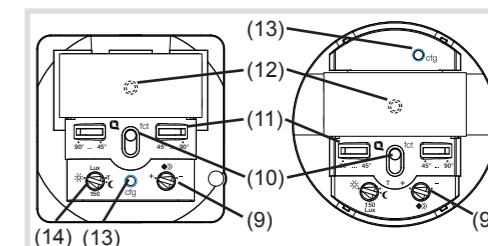

Fig. 5: Operating and adjustment elements of the bottom part of the application module

- (9) Sensitivity potentiometer
- (10) fct button
- (11) Detection angle adjuster
- (12) Status/fct LED
- (13) cfg button/LED
- (14) Response brightness potentiometer

Setting the detection area

The detection angle can be restricted for the right side and for the left side via each adjuster (Fig. 5, 10) between 45° ... 90°. Thus the detection angle can be between 90° and 180° (Fig. 8).

- Use the adjusters to set the detection angle for each side.

Setting the detection behaviour

Test mode must be used to test the detection performance. In test mode, the motion detector works independent of brightness. Each detection switches the lighting and the status LED on for 3 seconds. Thereafter motion detection will be deactivated for 2 seconds.

The motion detector is connected and ready for operation.

- Setting the test mode. To do so, set the response brightness potentiometer (Fig. 5, 13) to the T position.

- Leave the detection area and observe the switching behaviour.

If the motion detector switches on without motion in the detection field, then sources of interference (see Installation location) are present or the sensitivity is set too high.

- Reduce the sensitivity if necessary and blank out sources of interference by adjusting the detection angle or removing them.

- Check the detection area using a detection test and adjust if necessary.

If the detection area is too small, it can be extended via motion detector extension units or per radio via a master-slave configuration (see radio configuration).

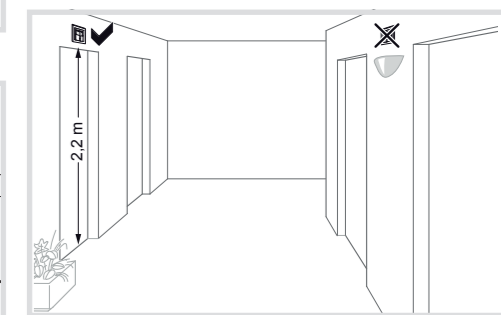
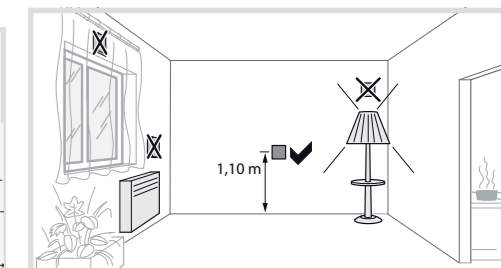
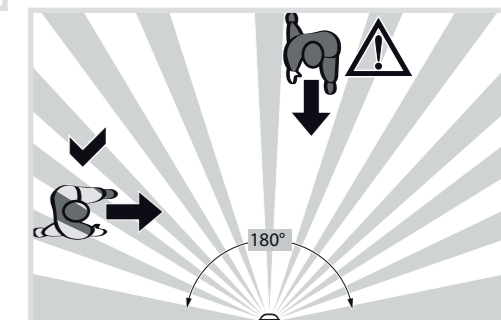

Fig 4: Installation location of the motion detectors

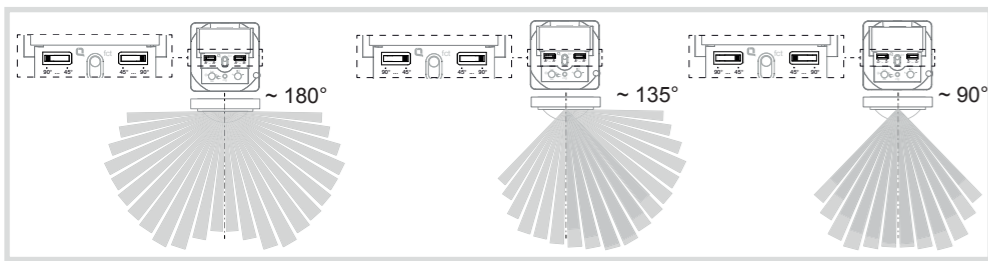

Fig. 8: Setting the detection angle

**Setting the response brightness**

The response brightness is the brightness value saved in the motion detector; when this value is undershot the motion detector switches the connected load if movements are detected. The response brightness can be set between approx. 5 (☼) over **150 Lux** to daytime operation (☼). The ☼ symbol stands for brightness-independent switching. The response brightness can be set variably in the intermediate areas.

To control the lighting in stairwells in accordance with DIN EN12464-1, 2003-3, turn the potentiometer to the **150 Lux** mark.

- Turn the response brightness potentiometer (Fig. 5, 14) to the desired position.

To save the current ambient brightness as response brightness, use the Teach-In function (see Setting the response brightness via Teach-In function).

**Setting the sensitivity**

Detection is factory-set to maximum sensitivity. If there are frequent incorrect detections, the sensitivity can be reduced.

- Turn the sensitivity potentiometer (Fig. 5, 9) to the desired position.

fct LED display	Configurable functions		Function resulting from transmitter operation, Notes	
	On switch insert	On flush-mounted dimmer		
off	On/OFF <sup>1)</sup>	ON/OFF, dimming UP/DOWN <sup>1)</sup>	ON/OFF, dimming UP/DOWN <sup>1)</sup>	Short press on push-button: Switching ON/OFF Long press on push-button: Dimming, reverse dimming direction per actuation
on	ON <sup>1)</sup>	ON, dimming UP <sup>1)</sup>	ON, dimming UP <sup>1)</sup>	Short press on push-button: Switching ON Push and hold button: Dimming UP to maximum brightness-level
off	OFF <sup>1)</sup>	OFF, dimming DOWN <sup>1)</sup>	OFF, dimming DOWN <sup>1)</sup>	Short press on push-button: Switching OFF Short press on push-button: Dimming DOWN to minimum brightness-level
1	Scene 1 <sup>1)</sup>			Receivers are allocated to a scene due to the configuration of the function. Short press on push-button: calling up the saved state of the connected load for the scene
2	Scene 2 <sup>1)</sup>			
Timer	Timer <sup>1)</sup>			Switching ON for the set switch-on time Factory setting 3 min
ON/OFF (switch/push-button)	ON/OFF (switch/push-button) <sup>1)</sup>			Closing of the actuating contact switches the load ON, opening of the contact switches the load OFF.
on	Forced mode ON			Switches the load with higher priority to the appropriate state. Execution of other commands is only possible after resetting the forced command.
off	Forced mode OFF			
Presence-simulation	Presence-simulation <sup>1)</sup>			Activates/deactivates execution of presence simulation (See activating/deactivating presence simulation).
Master-Slave	Master-Slave <sup>2)</sup>			Is used to extend the detection area. Receives switch-on commands in case of motion detection in the detection area of the transmitter (Slave). Switches the lighting ON for the set delay time. The brightness evaluation only takes place on the master, the slave only detects motion. Can only be configured between radio motion detectors.
Delete	Delete			No function Assignment to transmitter is deleted

<sup>1)</sup> Execution of the receiver function and local motion detector function have the same priority:  
- If the transmitter was first switched on/off and then motion was detected afterwards, then the motion detector will override the transmitter command  
- If motion was detected and thereafter during the delay time the system is switched on/off via the transmitter, then the transmitter will override the motion detector

<sup>2)</sup> Only with radio motion detector on power supply for radio application module as transmitter

Table 5: Configurable functions

**Radio configuration - quicklink**

The radio configuration sets the functional connection between commanding (transmitters) and function-executing (receivers) radio components. Thus wireless e.g. master, group, extension unit and time controls can be realised.

The following can be configured:

- The local operation of the load connected to the insert
- Radio commands to control other receivers
- Functions that are executed when radio commands are received

For configuration by means of Hager connection device TX100 or ETS, additional functions are available (see operating instructions for TX100 or application description for ETS).

**Configuration of radio motion detector as a receiver**

Configuration to control the load connected to the insert via reception of a radio command.

As an example the configuration of a wall-transmitter and a radio motion detector as receiver is described down below (Table 6).

**Configuration of motion detector as transmitter**

If the radio motion detector is operated as a transmitter, it can support the following functions for receivers. The specific function can vary depending on the receivers used:

- ON/OFF (delay time)  
Pre-configured command in automatic mode: Motion detection at simultaneous undershooting of the brightness threshold switches the load ON, and after the delay time elapses actively OFF. The delay time elapses in the motion detector and is permanently set (3 min).

Step	Result
<b>Start configuration</b> Short press on cfg button on the wall transmitter.	The cfg LEDs on the wall-transmitter and the radio motion detector light up in red colour.
<b>Select transmitter button</b> Short press on press-activation point on the wall-transmitter which should activate the function.	The cfg LED on the wall transmitter blinks for 1 second.
<b>Select function on receiver</b> Repeated short press on fct button on the motion detector until the desired function is displayed (Table 5).	After each operation, the fct LED indicates the function. If the transmitter button has already been configured with a function in a different receiver and/or the configured function is part of a group control, only this function can be configured. To change a function, the existing configuration must be deleted and the new one needs to be configured.
<b>Confirming function on receiver</b> To confirm, keep the fct button pressed for more than 2 seconds.	The cfg LED blinks during the saving process (approx. 5 s). The fct LED confirms the function selection by displaying the corresponding colour. Rapid blinking of the cfg LED indicates an impossible combination or an error.
<b>Finish configuration</b> Short press on cfg button on the wall transmitter again.	The cfg LEDs on the wall-transmitter, on the motion detector and on all receivers within radio range go out. The function is configured.

Table 6: Configuration of the function for the radio motion detector

Timer  
Motion detection at simultaneous undershooting of the brightness threshold switches the load ON and after the switch-on time elapse it switches the load OFF. The switch-on time elapses in the receiver and can be adjusted through configuration.

The radio motion detector must be attached to a switch insert or flush-mounted dimmer. If the radio motion detector is mounted on a power supply for radio application modules, then it can only be configured as a transmitting extension unit (slave) (see Executing a master-slave configuration).

Down below there is an illustration of the configuration of the radio motion detector with receivers, for which the supporting displays are executed via cfg LED and fct LED (Table 7). Different configuration displays, such as for receivers with display are provided in the instructions for the receiver.

**Executing the master-slave configuration**

If the radio motion detector is attached to a power supply for radio application modules, then it can only be configured as a transmitting extension unit (slave) to a radio motion sensor on switch insert or flush-mounted dimmer (Table 8).

The slave motion detector sends a pulse in case of motion detection in its detection area. Upon receiving this pulse, the master switches on for the delay time, if the set brightness threshold is undershot. Delay time and brightness threshold are determined by the master.

Step	Result
<b>Start configuration</b> Short press on cfg button on the radio motion detector.	The cfg LEDs on the radio motion detector and the receivers within radio range light up in red colour. Radio motion detector (transmitter) and receiver are in configuration mode
<b>Select function on receiver</b> Repeated short press on fct button on the receiver to select the desired function (see the receiver operating instructions).	After each operation, the fct LED indicates a function. If the radio motion detector has already been configured with a function in a different receiver and/or the configured function is part of a group control, only this function can be configured. To change a function, the existing configuration must be deleted and the new one needs to be configured.
<b>Confirming function on receiver</b> To save the allocation of command and function, keep the fct button on the receiver pressed for more than 2 seconds.	The cfg LED blinks. After successful saving, the fct LED signals the saved function. Rapid blinking of the cfg LED indicates an impossible combination or an error.
<b>Finish configuration</b> Short press on cfg button on the radio motion detector.	The cfg LEDs on the motion detector and all receivers within radio range go out. The radio command for the radio motion detector has been configured.

Table 7: Configuration of motion detector as transmitter

**Deleting a configuration**

To delete a configured receiver or the local operation, execute the configuration again.

- Start configuration (see Configuration of radio motion detector as a receiver).
- If necessary, Select transmitter button.
- The step select transmitter button step does not apply for radio motion detectors as transmitters
- Select function on receiver: Select the function Delete on the receiver and confirm function on the receiver.
- Finish configuration: Short press on cfg button on the transmitter.

**Configuration of group functions**

By means of a group function, one transmitter, for example, radio motion detector, controls several receivers. To do so, the same functions must be configured on all receivers.

- Start configuration (see Configuring radio motion detector as transmitter).
- Select function on receiver: Select the group function as described above on each receiver to be integrated and confirm function on the receiver.
- Finish configuration: Short press on cfg button on the transmitter.

**Setting of switch-on time for function „timer“**

In order to realise the function **Timer**, the switch-on time can be set on the receiver in stages. The factory setting is 3 min.

- Start configuration.
- If necessary select transmitter button: Select button with timer.

The step select transmitter button step does not apply for radio motion detectors as transmitters

Select function on receiver: If the function **Timer** is indicated by the fct LED blinking red (Table 5), keep pressed the fct button on the receiver for more than 5 seconds until the cfg LED blinks briefly.

The blinking fct LED indicates the currently set switch-on time - 5 x for factory setting (Table 9).

- Press fct button.
- Each short press on fct button increases the switch-on time by one step.

During the setting, the fct LED indicates the switch-in-on time (Table 9)

- To accept the selected switch-on time, keep pressed the fct button for longer than 2 seconds.
- Finish configuration: Short press on cfg button on the transmitter.

x-times flashing of the fct LED	Switch-on time
1	1 s
2	30 s
3	1 min
4	2 min
5	3 min
6	5 min
7	15 min
8	30 min
9	1 h
10	3 h

Table 9: Configurable switch-on times

**Resetting the radio motion detector to factory settings**

The device is not in configuration mode.

- Keep the cfg button pressed for more than 10 seconds until the cfg LED changes from a red lighting to blinking.
- Release the cfg button.
- The cfg LED blinks red rapidly. The device re-initialises itself. In the meantime the cfg LED lights up in red colour. After that the LED goes out and blinks 5 x to indicate the compatibility. The reset is made. The process lasts about 20 s.

This process deletes the complete configuration of the radio motion detector. Settings of the insert (switch-on brightness-level, load setting) are not reset.

Step	Result
<b>Start configuration</b> Short press on cfg button on the radio motion detector on the power supply (transmitter, slave).	The cfg LEDs on the radio motion detector (slave and master) light up in red colour.
<b>Select function on receiver</b> Short press on cfg button on the radio motion detector on the switch insert or flush-mounted dimmer (master) to select the master-slave function.	The fct LED blinks orange periodically (see Table 5).
<b>Confirming function on receiver</b> Only the master-slave function or delete can be selected in this configuration.	
<b>Confirming function on receiver</b> To save the allocation of command and function, keep the fct button on the receiver (master) pressed for more than 2 seconds.	The cfg LED blinks. After successful saving, the fct LED signals the saved function. Rapid blinking of the cfg LED indicates an error.
<b>Finish configuration</b> Briefly activate the cfg button on the wall transmitter.	The cfg LEDs on the radio motion detectors and all receivers within radio range go out. The master-slave configuration has been executed.

Table 8: Execution of the master-slave configuration

**Appendix**

**Technical data**

Connection	Mounting on suitable inserts
Power supply	via inserts
Response brightness	approx. 5 ... 1000 lux (∞)
Sensitivity	approx. 10 ... 100 %
Detection angle	approx. 90 ... 180°
Detection area (1.1 m)	approx. 12 x 16 m
Detection area (2.2 m)	approx. 8 x 12 m
Transmission frequency	868-870 MHz
Emission Power	25mW
Radio protocol	KNX Radio RF1.M
Quicklink logic functions	max. 20 transmitters/receivers
Receiver category	2
Transmitter duty cycle	0.1 %
Protection type	IP 20
Relative humidity	0 ... 65 % (no condensation)
Ambient temperature	-5 ... +45 °C
Storage/transport temperature	-20 ... +60 °C
Mounting orientation	interface between application and power module on top

**Accessories**

Relay insert	WUC35
Universal switch insert 1-gang	WUC21
Touch dimmer (R, L)	WUD86
Universal touch dimmer 1-gang	WUD87
Power supply for radio application module	WUC18

Useable all in Europe CE and in Switzerland.  
Hereby, Hager Controls declares this radio transmitter/receiver is in compliance with Directive 2014/53/EU.  
The complete text of the EU declaration of conformity is available on the website www.hagergroup.com.