

**GB Design 30 Evolution Consumer Unit
Instructions/Data Sheet**

This Consumer Unit and Hager devices conform with the following standards:
Consumer Unit: BS EN 61439-3 including Annex ZB.
Switch-disconnectors: BS EN 60947-3.
Residual Current Circuit Breaker (RCCB): BS EN 61008-1
Residual current operated circuit breaker with integral overload (RCBO): BS EN 61009-1
Miniature Circuit Breaker (MCB): BS EN 60898-1
Arc Fault Detection Devices: BS EN 60626
Surge Protection Devices: BS EN 61643

Important notice:
 To prevent potential overheating from loose connections the installer shall check connections are tight to the torque levels stated in these instructions prior to energizing this board. This check should include factory made connections which may have loosened in transit.

Good workmanship and proper materials must be applied by the installer. The cable entry method shall, as far as reasonably practical, maintain the non-combustible arrangement of the enclosure. Account shall be taken of these instructions.

For guidance on RCD selection, AFDD selection and more, see the related BEAMA guide in our BEAMA guide web page - hager.co.uk/18thedition.

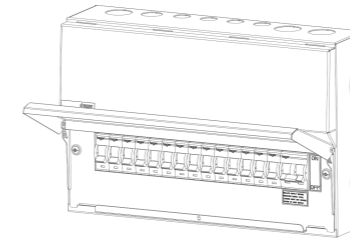

Installation Instructions:
 All product(s) must be installed by a suitably competent electrician giving consideration to their intended use and in accordance with the current edition of BS 7671 (IET Wiring Regulations).

The Electricity at Work regulations and the Health and Safety at Work Act shall be complied with.

Only equipment and arrangements specified in Hager's technical documentation / catalogue shall be used.

Install in the horizontal plane only.

For guidance when making connections in a consumer unit electrical safety first / BEAMA document "Guidance for installers when making connections in consumer units" is available from hager.co.uk/63026.htm

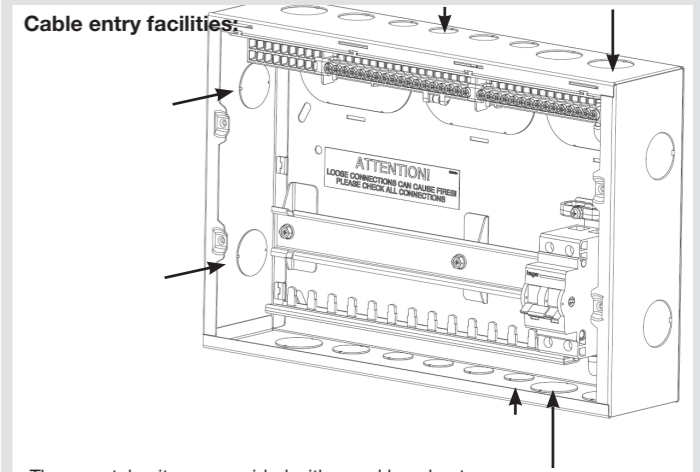
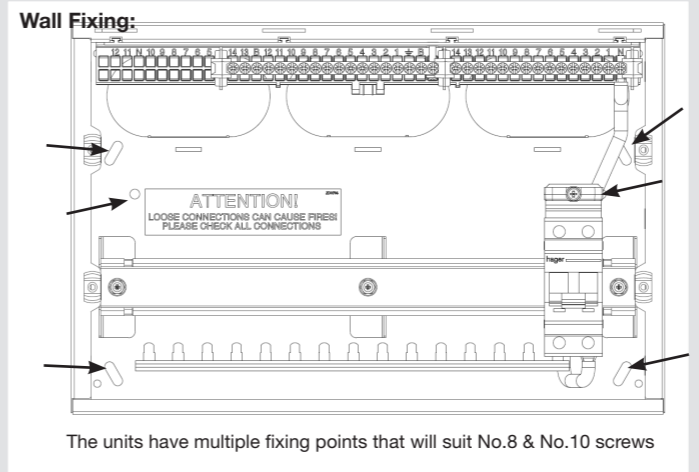

These metal units are provided with round knockouts Sized from 32mm, 25mm & 20mm positioned top, bottom and 2 x 32mm knockouts on both sides and also large rear knockouts.

Accessories Comparison
 Surface Mounted Consumer Units

Feature	Description
Rear cable entry plate (VM02CE)	Allows cables to enter the rear of the board without the risk of damage from sharp edges.
Stand-off plate (VM01SP)	Provides 12mm of clearance at the rear of the consumer unit to allow surface mounted cables to enter the board from the rear.

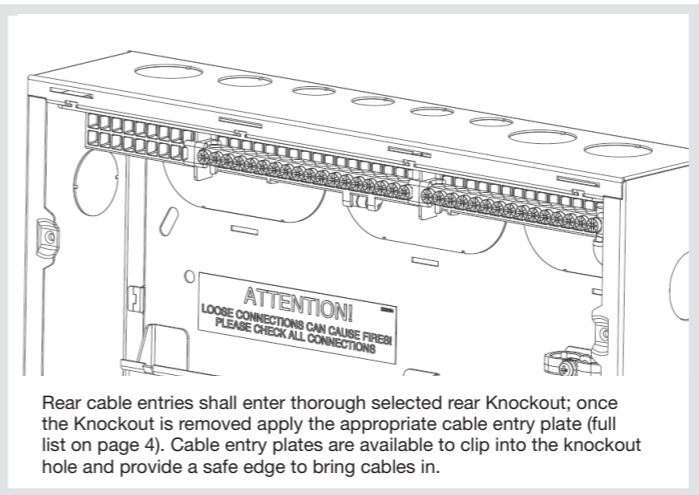

Note: Only BASEC approved cable should be used 1.0mm² to 16mm² for outgoing cables

Up to 35.0mm² for incoming live cables. Single conductors below 1.5mm² need to be doubled back in the terminal bar.

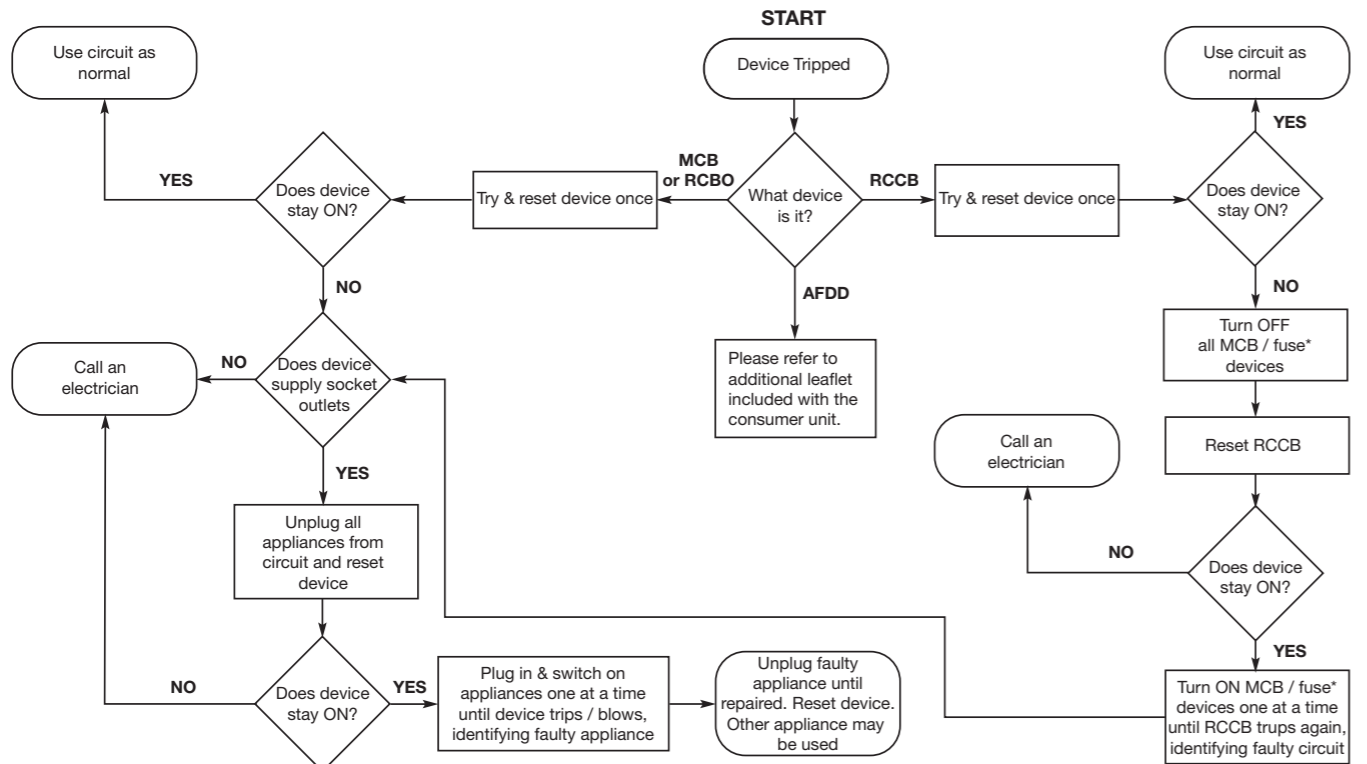

* Important note: Fuse carriers must not be opened or closed with the main switch in the ON position.

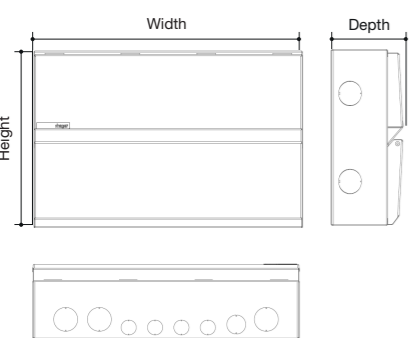

Design 30 EVO Dimensions (mm)

	Enclosure Size						
	2	3	4	5	6	7	
Height	240	240	240	240	240	240	
Width	149	221	293	364	400	472	
Depth	102.5	102.5	102.5	102.5	102.5	102.5	

Number of Knockouts

	2	3	4	5	6	7
Top Face 32mm	1	1	3	3	3	3
Top Face 25mm	1	1	1	1	1	1
Top Face 20mm	1	3	2	4	5	7
Bottom Face 32mm	1	1	3	3	5	3
Bottom Face 25mm	1	1	1	1	3	1
Bottom Face 20mm	1	3	2	4	5	7
Back 100 x 50	1	1	1	3	3	3
Side's 32mm	4	4	4	4	4	4

Design 30 EVO Dual Row Dimensions (mm)

	Enclosure Size				
	3 (2)	4 (2)	5 (2)	6 (2)	7 (2)
Height	480	480	480	480	480
Width	221	293	364	400	472
Depth	102.5	102.5	102.5	102.5	102.5

Number of Knockouts

	3 (2)	4 (2)	5 (2)	6 (2)	7 (2)
Top Face 32mm	1	3	3	3	3
Top Face 25mm	1	1	1	1	1
Top Face 20mm	3	2	4	5	7
Bottom Face 32mm	1	3	3	5	3
Bottom Face 25mm	1	1	1	3	1
Bottom Face 20mm	3	2	4	5	7
Back 100 x 50	1	1	3	6	6
Side's 32mm	4	4	4	4	4

Guidance Notes:

The total load must not exceed the rating of the incoming device or the assigned assembly rating (InA) whichever is the lower. Each neutral and earth connection must correspond numerically to its outgoing way. Additional blanks (ref. JK01B) are available to cover spare ways.

A pack is provided to label this consumer unit, please consult us for spares or replacements. Operating Instruction leaflet is provided overleaf. This leaflet should be left for the end user.

Single conductors below 1.5mm² need to be doubled back in the terminal bar. Consumer Units incorporating RCDs in TT systems should incorporate an S type (time Delayed) RCCB, e.g. 100 mA s-type RCCB. Alternatively a main switch with RCBO protection on all outgoing circuits should be used. Precautions need to be taken to prevent faults to earth on the supply side of the RCD (as per BS7671 regulation 531.4.1)

ZD0904

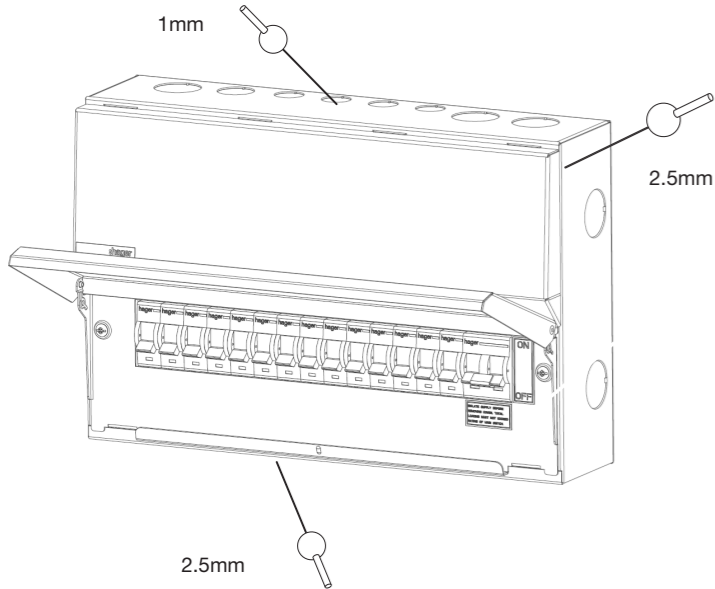

Fitting Hager MCBs and RCBOs:

Only equipment and arrangements specified in Hager's technical documentation / catalogue shall be used.

1. Isolate the electrical supply from the consumer unit.
2. Remove the front cover, by loosening the two captive screws.
3. Fully slacken the lower terminal of the device.
4. Fully open the bottom device clip (fig 1.)
5. Locate the device onto the din rail, and busbar. Ensure that the busbar tooth is within the device terminal cage.
6. Close the bottom device clip.
7. While holding the device firmly onto the busbar, fully tighten the lower terminal screw.
8. After fitting all outgoing devices and connecting all outgoing cables, please check the tightness of all cable connections. This should include all factory made connections, which may have loosened during installation or transit.

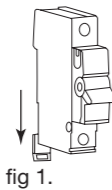

Cable Access:

Cable access into the metal consumer unit must maintain the integrity of the non-combustible consumer unit so far as reasonably practicable. This can generally be achieved by the installer ensuring that cable access holes they make in the enclosure do not to leave gaps greater than:

- 1.0 mm for the horizontal top surface and
- 2.5 mm for all other surfaces of the enclosure that are accessible after installation.

For rear cable access, the minimum number of knockout(s) shall be removed.

Tests on hager consumer units have indicated that there is no specific need for external fire rated cable glands or intumescent sealing in addition to the guidance below, with respect to achieving a non-combustible enclosure. However this does not preclude the designer/installer from using fire rated cable glands or external intumescent sealing should they consider necessary. Internal intumescent pads shall not be used.

Selection of RCDs

Different types of RCD exist, depending on their behaviour in the presence of DC components and frequencies.

Overload protection of switches and RCCBs

This can be achieved by:

Method 1

Ensure the sum of the rated current of the downstream MCBs do not exceed the rated current of the switch or RCCB (I_{nc}). This method would however need to consider the consequences of any spare ways and later additions.

Method 2

Ensure that the rated current of a switch or RCCB (I_{nc}), stated by the assembly manufacturer, is not less than the rating of the upstream OCPD. For a domestic installation this could be a 100A cut-out fuse.

Method 3

Select a consumer unit or distribution assembly that only utilises RCBOs on outgoing circuits. Consideration will still need to be given as to the rated current of the main switch.

For more information on these subjects we have made the relevant BEAMA guides available on our 18th edition hub on our website at hager.co.uk/18thedition

Warranty

This distribution board is offered with a 24 month warranty against defective material or manufacture. If a warranty claim is necessary, please call the technical support number given at the bottom of the page and we will be pleased to help.

For dimensional information and weights please consult the Hager catalogue.

For boards with Surge Protection fitted (References ending in SPD)

SPB015, SPB015N

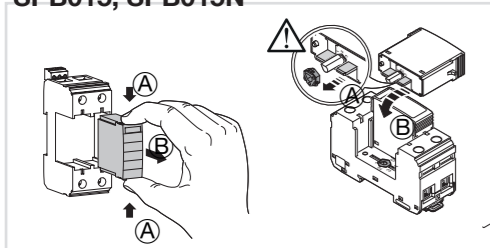

Fault indication

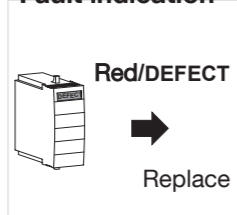

Where surge protective devices (SPDs) or other equipment are likely to influence the verification test, or be damaged, such equipment shall be disconnected before carrying out the insulation resistance test.

Technical Service Centre: 01952 675 689
Technical Fax: 01952 675 557
Technical E-mail: technical@hager.co.uk

Website: hager.co.uk

Torque Settings

	Pz No.	(mm)	Cables >1.5mm ² Tightening torque (N.m)		Cables ≤1.5mm ² Tightening torque (N.m)		Cable Stripping (mm)
			Single Cable	Multi Cables	Single Cable	Multi Cable	
Consumer unit terminals							
Earth and neutral terminal bars	2	6.5	2	2	1.5	1.5	10
Isolation							
Switch Disconnectors / Surge	2	6.5	3.6	3.6	3.6	3.6	15
Circuit protection							
MCB	2	6.5	2.8	2.8	2.8	2.8	13
RCBO	2	5.5	2.1	2.1	2.1	2.1	13
RCCB	2	5.5	3.3	3.3	3.3	3.3	13
AFDD	2	2	2.1	2.1	2.1	2.1	13

ZD0904

Interface characteristics

Rated & operational voltage (Un / Ue)

230V a.c. 50Hz

Rated insulation voltage (Ui)

320V a.c. 50Hz

Rated impulse withstand voltage (Uimp)

4kV

Rated current of the Assembly (InA)

100A, 63A, 40A

Note: Dependent upon rating of main incoming device

Rated current of an Outgoing circuit (Inc)

MCB 6A - 63A (marked rated current on device)
RCBO 6A - 50A (marked rated current on device)

Rated current of outgoing unit (Inc)

RCCB 40A -100A (marked rated current on device)

Rated conditional short-circuit current of the ASSEMBLY (Icc)

Annex ZB: 16 kA rms at 250V, power factor 0.6 with equipment and arrangements specified in Hager's technical documentation / catalogue.

Protection against electric shock

Consumer unit shall be installed in an electrical system conforming to the current edition of IEC 60364 / BS 7671

Rated diversity factor (RDF) / Values of assumed loading

- 1way = 1.0
- 2way – 3way = 0.8
- 4way – 5way = 0.7
- 6way – 9way = 0.6
- 10way and above = 0.5

Note: RDF only applies to continuously and simultaneously loaded circuits.

In principle, this means adjacent circuit-breakers having a load 'on' time exceeding 30 minutes or where a load not exceeding 30 minutes has an 'off' time less than the 'on' time, will need to have the rated diversity factor applied as indicated.

Rated frequency (fn)

50 Hz

Pollution degree

2

Types of system earthing for which the ASSEMBLY is designed

TNC-S, TN-S when installed in an electrical installation complying with BS 7671
Hager recommends for TT systems a 100A type S time delayed RCCB or a main switch with RCBO protection only on all outgoing circuits.

Indoor use only

Stationary ASSEMBLY

Degree of protection

IP2XC with Door Open / closed and full compliment of outgoing devices and or blanks fitted.
Note: Where cables are installed through top wall of enclosure, gaps of IP4X to be maintained.

Intended use

Intended for use in domestic (residential) or similar premises.

Electromagnetic compatibility (EMC) classification

EMC Environment B

External design

VME: Wall-mounted, surface type, enclosed assembly.

Mechanical impact protection

IK 05

The type of construction

Fixed parts

Type A DBO (Distribution board for use by ordinary persons)

ZD0904