

- (FR) Contact auxiliaire
- (EN) Auxiliary contact
- (ES) Contacto auxiliar
- (PT) Contacto auxiliar
- (IT) Contatto ausiliario
- (EL) Βοηθητική επαφή

CZN200P

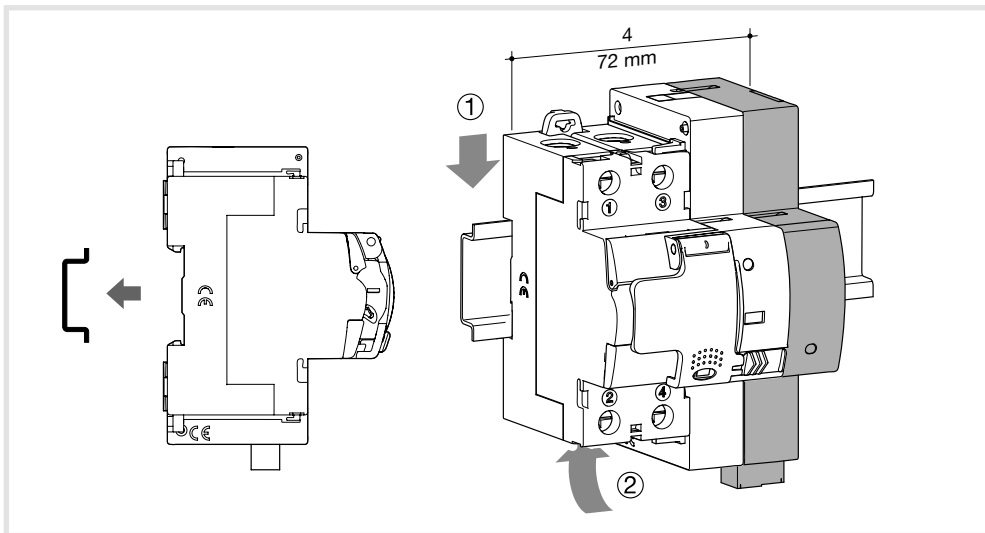

- (FR) Appareil à installer uniquement par un installateur électricien selon les normes d'installation en vigueur dans le pays.
- (EN) This device must be installed only by a qualified electrician according to the installation standards in force in the country.
- (ES) Este aparato debe ser instalado obligatoriamente por un electricista cualificado según las normas de instalación vigentes en el país.
- (PT) Aparelho a ser instalado apenas por um técnico habilitado de acordo com as normas de instalação em vigor no país.
- (IT) L'apparecchio va installato unicamente da un elettricista qualificato secondo le norme d'installazione in vigore nel paese.
- (EL) Η συσκευή πρέπει να τοποθετηθεί αποκλειστικά από ηλεκτρολόγο σύμφωνα με τους κανονισμούς τοποθέτησης που ισχύουν στη χώρα σας.





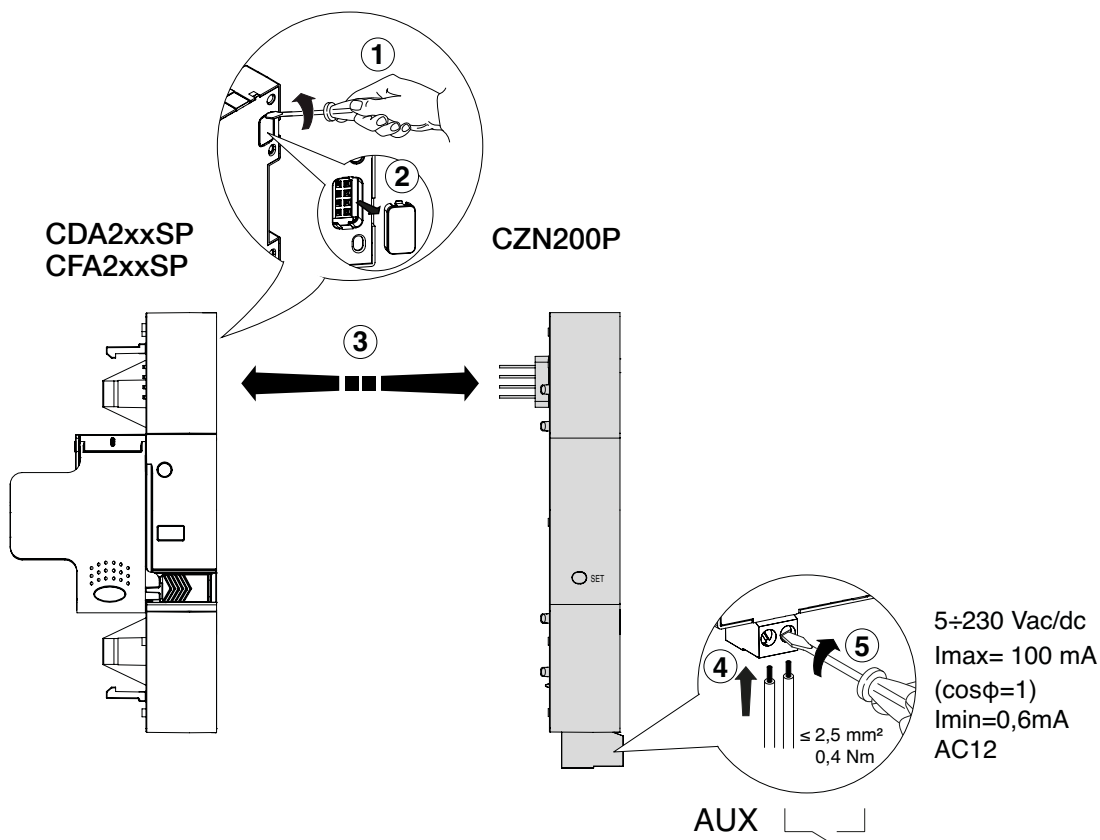

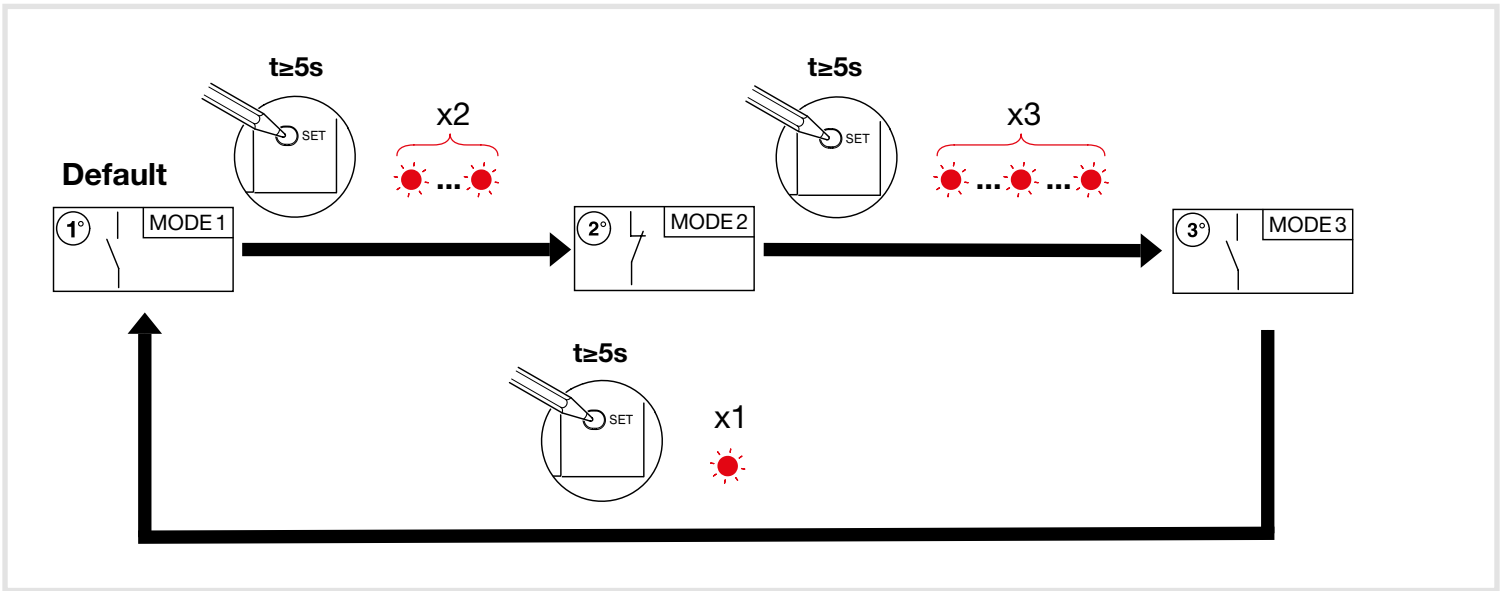
Assemblage / Assembling / Montaje / Instalação / Assemblaggio / Εγκατάσταση





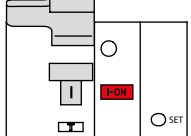

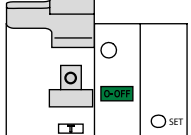





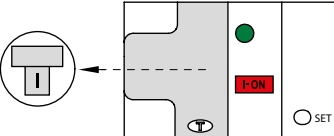

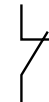

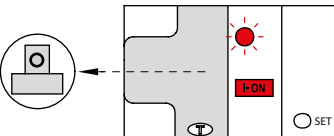

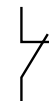
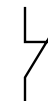

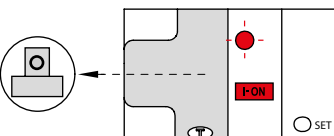
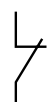

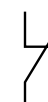

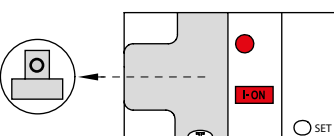
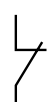
				
		MODE 1	MODE 2	MODE 3

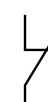
CDA2xxSP OFF

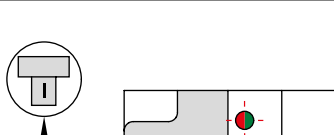
○	 I - ON				
○	 O - OFF				

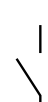
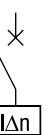
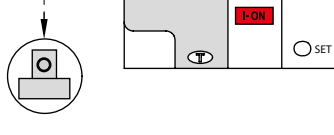
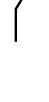
CDA2xxSP ON

●	 I - ON				
☀	 O - OFF				
☀	 O - OFF				
●	 O - OFF				
☀	 I - ON				
☀	 O - OFF				

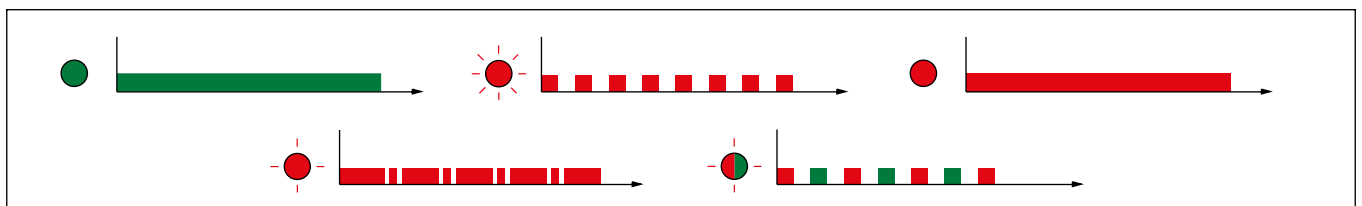

EN Warranty NOT APPLICABLE FOR AUSTRALIA

A warranty period of 24 months is offered on hager products, from date of manufacture, relating to any material of manufacturing defect. If any product is found to be defective it must be returned via the installer and supplier (wholesaler). The warranty is withdrawn if:

- after inspection by hager quality control dept the device is found to have been installed in a manner which is contrary to IEE wiring regulations and accepted practice within the industry at the time of installation.
- The procedure for the return of goods has not been followed. Explanation of defect must be included when returning goods.

FR Garantie

24 mois contre tous vices de matières ou de fabrication à partir de leur date de production. En cas de défectuosité, le produit doit être remis au grossiste habituel. La garantie ne joue que si la procédure de retour via l'installateur et le grossiste est respectée et si après expertise notre service contrôle qualité ne détecte pas un défaut dû à une mise en œuvre et/ou une utilisation non conforme aux règles de l'art. Les remarques éventuelles expliquant la défectuosité devront accompagner le produit.

ES Garantía

Válida 24 meses contra todos los defectos de material o fabricación. En caso de defecto, el producto debe ser retornado a su distribuidor habitual. La garantía no será válida si el procedimiento de retorno no se realiza vía instalador y distribuidor o si nuestro servicio de control de calidad detecta un defecto debido a la mala utilización o a una instalación no conforme con la hoja de instrucciones y de montajes. La devolución del producto deberá ir acompañada de un informe, detallando los motivos de la devolución.

PT Garantia

24 meses contra defeitos dos materiais ou de fabrico, a partir da data de produção. No caso de avaria, o produto deve ser enviado ao seu distribuidor habitual.

A garantia só é válida se forem respeitados todos os procedimentos de devolução, instalador via distribuidor, se os nossos serviços de controlo de qualidade não detectarem más ligações e/ou uma utilização não conforme com as regras de arte. Todas as informações que expliquem o defeito deverão acompanhar o produto.

IT Garanzia

24 mesi contro tutti i difetti di materiale o di fabbricazione, a partire dalla data di produzione. In caso di difetti, il prodotto deve essere restituito al grossista da cui è avvenuto l'acquisto. La garanzia ha valore solo se viene rispettata la procedura di reso tramite installatore e grossista e se dopo la verifica del nostro servizio controllo qualità non vengono riscontrati difetti dovuti ad una errata messa in opera e/o ad una utilizzazione non conforme alla regola dell'arte, ad una modifica del prodotto. Le eventuali note informative del difetto dovranno essere allegate al prodotto reso.

EL Εγγύηση

Εγγύηση 24 μηνών προσφέρεται στα προϊόντα της Hager από την ημερομηνία παραγωγής τους, για κάθε ελάττωμα στα υλικά ή την κατασκευή. Εάν κάποιο από τα προϊόντα βεθεί ελαττωματικό πρέπει να επιστραφεί μέσω του εμπόρου. Η εγγύηση δεν ισχύει εάν:
- κατά τον έλεγχο από το τμήμα ποιότητας της Hager βεθεί ότι η εγκατάσταση έγινε αντίθετα με τους κανονισμούς IEE και την ισχύουσα πρακτική.
- δεν έχει ακολουθηθεί η διαδικασία για την επιστροφή του υλικού. Η επιστροφή του υλικού πρέπει να συνοδεύεται με περιγραφή του σφάλματος.