

Application description

KNX thermostat

KNX room controller







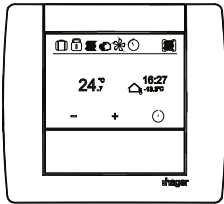

- ▲  Manufacturer
- ▲  Hager Elektro
- ▲  KNX thermostat
 -  KNX thermostat with display and integrated bus application unit
 -  KNX room controller with display and integrated bus application unit

Application description

KNX thermostat with display and integrated bus application unit
 KNX room controller with display and integrated bus application unit



	Order number	Product designation	Application programme	TP product 
	WKT510	KNX thermostat with display	SWUT0x 	
	WKT511	KNX room controller with display	SWUT0x 	

1.	General information about this application description	5
2.	Functional and device description	5
2.1	System overview	6
2.2	Display elements and operating concept	7
3.	ETS Programming / Settings	9
3.1	General information about the programming software	9
3.1.1	ETS Programming software	9
3.1.2	 ETS Application designation	9
3.1.3	Programming mode	9
3.2	Settings in the ETS	10
3.3	Selection Room Thermostat Type	12
3.3.1	Hotel mode function	12
3.4	Display	15
3.4.1	General	15
3.4.2	User messages	17
3.4.3	Time	18
3.4.4	Basic display	19
3.4.5	State of the house	20
3.4.6	Blocking function	23
3.4.7	Button (only room controller)	24
3.5	Room thermostat	25
3.5.1	General	25
3.5.2	Operating mode	29
	3.5.2.1 Operating mode changeover	30
	3.5.2.2 Notes on operating modes	33
	3.5.2.3 Transmission of set temperature	34
	3.5.2.4 Operating modes and operating modes changeover	34
3.5.3	Basic heating	36
3.5.4	Additional heating	37
3.5.5	Basic cooling	38
3.5.6	Additional cooling	39
3.5.7	Temperature measurement	40
3.5.8	Ventilation	43
3.5.9	Transmission settings	47
3.5.10	Setpoints	48
3.5.11	Setpoint shift	51
3.5.12	Scene settings	52

Application description

KNX thermostat

KNX room controller

3.6	Temperature sensor settings	53
3.6.1	Internal temperature sensor	53
3.6.2	External temperature sensor	54
3.7	Push-button functions	55
3.7.1	Display mode "Multiple functions" / "Rocker function"	56
3.7.1.1	Multiple function button	57
3.7.1.2	Button Rocker function	57
3.7.2	Toggle switch function	58
3.7.3	Function switching	59
3.7.4	Function Dimming	60
3.7.5	Shutter/blind function	61
3.7.5.1	Shutter function	61
3.7.5.2	Function blind	62
3.7.6	Timer function	64
3.7.7	"Value 1 byte" function	65
3.7.8	Value 2 bytes function	66
3.7.9	Priority function	67
3.7.10	Scene function	68
3.7.11	Deactivate automatic function	69
3.7.12	Blocking function	70
3.8	Info	70
4.	Settings on the display	71
4.1	Basic display	71
4.1.1	Display of temperatures	71
4.1.2	Display of date and time	71
4.2	Page Status	72
4.2.1	Display of user messag	72
4.2.2	Display of status messages - State of the house	72
4.3	Page No problem	73
4.4	Page Settings	74
4.4.1	Setpoint heating	74
4.4.2	Setpoint cooling	75
4.4.3	Internal sensor	76
4.4.4	External sensor	76
4.4.5	Heating or cooling mode	77
4.4.6	Date/time	77
4.4.7	24h/12h Time format	78
4.4.8	Screen brightness	79

Application description

KNX thermostat

KNX room controller

4.4.9	Screen saver	79
4.4.10	Language	81
4.4.11	Programming mode	81
4.4.12	Reset	82
4.4.13	Info	82
4.5	Timer	83
4.6	Holiday mode	84
4.7	Page Operating mode	85
4.8	Page Extractor fan	86
5.	Room controller/push-button function	87
5.1	Function switching	87
5.1.1	Switching in "Rocker" function	87
5.1.2	Switching in "Button" function	87
5.2	Toggle switch function	89
5.2.1	Switching in "Toggle switch" function	89
5.3	Function Dimming	90
5.3.1	Dimming in "Rocker" function	90
5.3.2	Dimming in "Button" function	90
5.4	"Roller shutter/blind" function	91
5.4.1	Roller shutter/blind in "Rocker" function	91
5.4.2	Roller shutter/blind in "Button" function	92
5.5	Timer function	93
5.5.1	Timer in "Button" function	93
5.6	Additional functions	93
6.	ETS software characteristics	94
7.	Technical data	94
8.	Accessories	94
9.	Appendix	95
9.1	Heating and cooling control types	95
9.1.1	Automatic change-over heating/cooling	95
9.1.2	2-point control	96
9.1.3	Continuous PID control	96
9.1.4	Switching PID control (PWM)	96

Application description

KNX thermostat

KNX room controller



1. General information about this application description

This document describes the operation and parameterisation of KNX devices with the aid of the Engineering Tool Software ETS.

The devices thermostat and room controller are parameterised by the ETS during initial installation and the required settings are made. Furthermore, the devices offer the possibility to change settings on display.

Symbol description:

Descriptions which list the  display sign, are device settings that can be made via the display.

Descriptions which list the  ETS sign, are device settings that can be made in the ETS software only.

2. Functional and device description

The KNX thermostat can be used to control the temperature of individual rooms. In the course of this, the command value for the heating or cooling control is sent to the KNX bus depending on the operating mode and room temperature.

Additional functions of the device are e.g. fan coil control, holiday mode, status display , etc..

The device „KNX thermostat“ compares the current room temperature with the set temperature and controls heating and cooling devices according to the current requirements.

In addition, from firmware 1.1.5, the device has a so-called "Hotel mode function". This function can be used wherever untrained users need a simple and understandable way to intervene in the temperature and fan control. In addition, the users should not be able to intervene in the system. Possible locations for this function could be not only hotels, but also offices, schools or public buildings.

There is also an option to centrally undo the changes made by users.

The device „KNX room controller“ also has push-button functions. Here, the following functions can be retrieved: ON/OFF, dimming, shutter/blind, light scene activation, priority. The assignment of the various functions is freely selectable and is defined by parameterisation in the ETS. Depending on the parameterised functions, telegrams that trigger ON/OFF, dimming, blind/shutter functions, call up or save light scenes and set dimming, brightness or temperature values in the corresponding actuators are transmitted to the KNX system bus when touch control surface is pressed.

Application description
KNX thermostat
KNX room controller
2.1 System overview

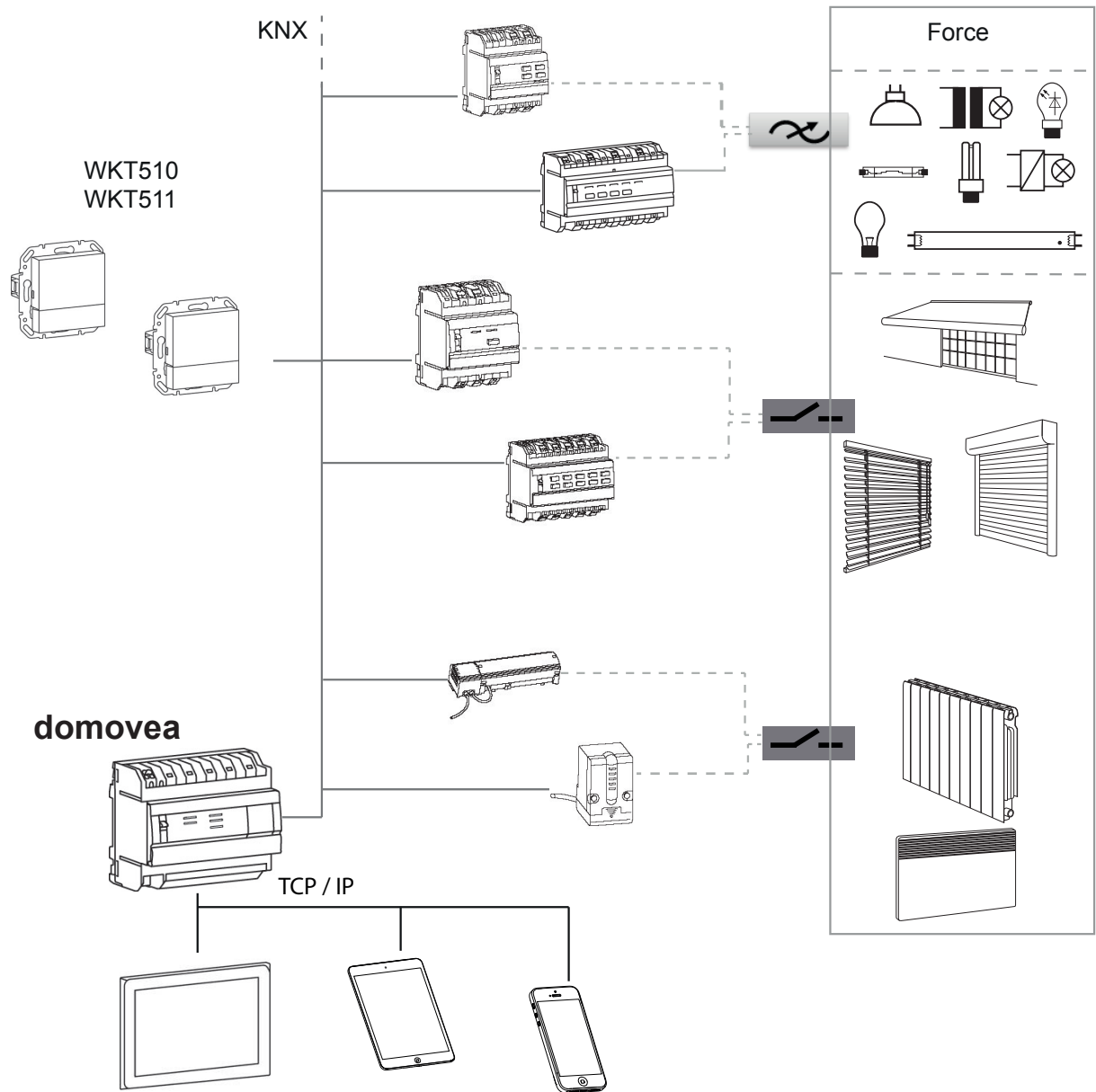

Figure 1: System overview

Application description

KNX thermostat

KNX room controller

2.2 Display elements and operating concept



The device is subdivided into a display area (1) and a control surface area (2). On the page "Basic display" symbols indicate the set/active parameters in the upper row of the display. The lower row of the display area changes its display depending on the page. Symbols indicate the functions that can be triggered using the touch control surface (2) below. Greyed out symbols indicate a deactivated function.

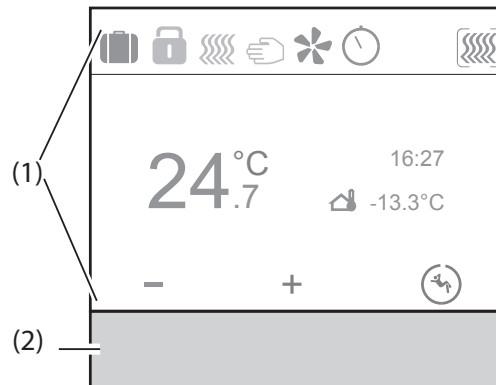

Figure 2: Display elements

- (1) Display area
- (2) Operating area

- Push-button operation:

The stored function is executed by pressing the touch control surface below the displayed symbol (3).

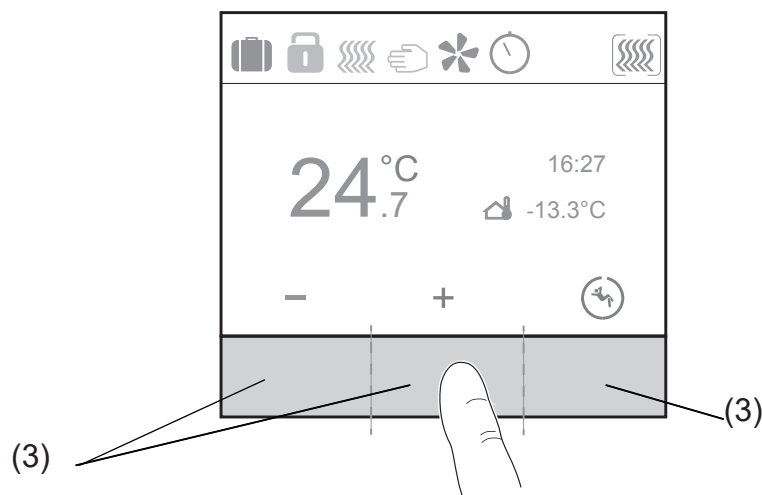

Figure 3: Operating concept "Push-button operation"

- (3) Push-button zones

- Slider operation:

The respective pages are navigated to by "swiping" over the capacitive touch control surface (4). Here, the movement can take place from left to right or reverse direction. The swiping action on a submenu page brings you back to the main page.

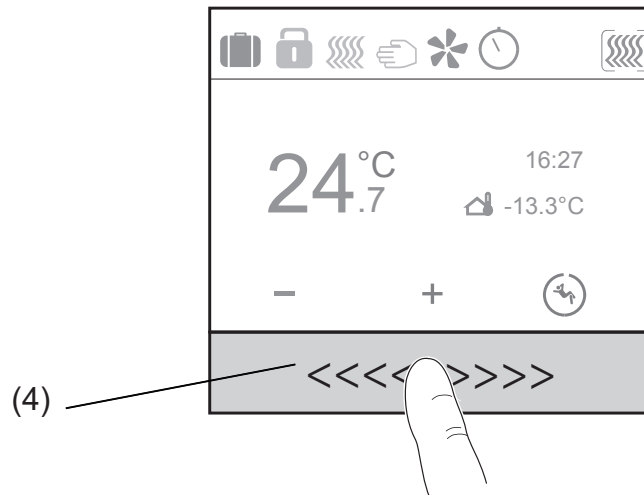

Figure 4: Operating concept "Slider operation"

(4) Slider control surface

Loads, such as lighting or blinds, are operated using the touch-sensitive control surface and is dependent on the device configuration.

- Press a touch control surface below the symbols.

The underlying function is executed.

- i** The pulse lasts for the duration of the actuation. Depending on the function, short and long touches can trigger different actions, e.g. switching/dimming.

3. ETS Programming / Settings

3.1 General information about the programming software

3.1.1 ETS Programming software

The application programmes are compatible with ETS5 or ETS4 and are always available in their latest version on our internet website.

ETS version	File extension of compatible products	File extension of compatible projects
ETS 4 (v 4.18 or higher)	*.knxprod or *.vd5	*.knxproj
ETS 5 (v 5.04 or higher)	*.knxprod	*.knxproj
ETS 6	*.knxprod	*.knxproj

Table 1: ETS Software version

3.1.2 ETS Application designation

Application	Article order number
SWKT510	KNX thermostat with display and integrated bus application unit
SWKT511	KNX room controller with display and integrated bus application unit

Table 2: ETS Application designations

3.1.3 Programming mode

On the Settings page after selecting the "Programming mode" menu item, you can load the physical address via the ETS.

At the factory this is 15.15.255

Menu setting → Programming mode



Application description

KNX thermostat

KNX room controller

3.2 Settings in the ETS



-  The application software imported to the ETS is identical for the devices "Thermostat with display and integrated bus coupling unit" and "Room controller with display and integrated bus coupling unit".
-  In the first step, the device variants used must be selected.
-  The settings made on the display prior to programming by the ETS will be overwritten by an ETS download.

Menu Room Thermostat Type

In the menu Room Thermostat Type you have to choose between the thermostat variants or room thermostats.

Menu Display

In the Display menu, the basic parameters for operation of the device must be set, such as language, time, time format, display brightness, screen saver, basic display etc.

Menu Thermostat

In the Thermostat menu, the parameters for heating, cooling operation, fan, temperature setpoints (comfort, standby, night operation, frost/heat protection) and the scene settings must be parameterised.

Menu Internal temperature sensor

The settings for the internal temperature sensor must be performed in the Internal temperature sensor menu.

Menu External temperature sensor

The settings for the external temperature sensor must be performed in the External temperature sensor menu.

i In addition to the functions of the thermostat, the room controller has the option to create your own display pages. On these pages, it is possible to create switching, dimming and roller shutter/blind functions among other things.

Not active

The "Not active" function means that no function is assigned to the button; the button is disabled. No further page is generated in the display.

Toggle switch

The "Toggle switch" function switches on the load upon the first key-press and switches it off again upon the second. "Page Button function"

Switching

The "ON/OFF" function enables the push-button (lighting circuits, for example) to be switched on or off (ON, OFF, ON/OFF, for example).

Dimming

The "Dimming" function enables the push-button to increase and decrease the dimming in lighting circuits. This function can either be used as a rocker (for example, left side of the rocker dims up, right side dims down) or as a button (first key-press dims up, second dims down (during toggle mode)).

Roller shutter / blind

The "Shutter/blind" function allows blinds, shutters, awnings or similar hangings to be opened and closed.

This function can either be used as a rocker (for example, left side of the rocker OPENS shutter, left side CLOSES shutter) or as a button (first key-press OPENS shutter, second CLOSES shutter (during toggle mode)).

Timer

The "Timer" function enables the actuator output to be switched on or off for an adjustable duration. The switching time can be interrupted before the delay time elapses. An adjustable switch-off warning signals the end of the delay time by inverting the output state for 1 s.

Value 1 byte/2 bytes

The value transmitter (1 byte) function allows values from 0 ... 255 or 0 ... 100% to be transmitted to a dim actuator, for example.

The value transmitter (2 bytes) function allows values from 0 to 65535, brightness values from 0 to 1000 lx or temperature values from 0 to 40°C to be configured.

Priority

The Priority function makes it possible to specify a defined state or to force a defined state of the function.

Scene

With this function, a light scene can be called up in a KNX device (scene extension). A scene can have various functions e.g. light circuit 1 ? dimming, lower shutter 1 ?, TV lighting ? ON, merge into a group. A maximum of 64 scenes are available.

Automatic control deactivation

This function can be used to interrupt and deactivate ongoing operations (time-controlled lighting).

Application description

KNX thermostat

KNX room controller

3.3 Selection Room Thermostat Type



In the first step, the KNX thermostat or KNX room controller device variants used must be selected in the application software. If the KNX room controller is selected, the parameters of buttons 1 ... 9 are visible.

Room thermostat type

Figure 5: Selection device variant

Parameter	Description	Value
Product	With this parameter, the device type used must be selected at the beginning of the parameterisation	KNX thermostat* KNX room controller
Hotel mode	If the box is ticked (Figure 5, 1), only the Hotel mode function is activated. This makes it easier to choose the temperature and fan control functions.	

Table 3: Selection device variant

3.3.1 Hotel mode function

The Hotel mode function restricts the settings that can be made by the user on the display. This means that when the Hotel mode function is activated, only this function remains visible and configurable.

The functions set and configured in the ETS continue to be executed in the background.

To use the Hotel mode function, the function must be selected (Figure 5, 1) (tick the box).

f The Hotel mode function is only available as of firmware version 1.1.5.

f The Hotel mode function is only available in the device variant **KNX thermostat**.

Once the Hotel mode function has been selected, the following settings should be checked during configuration; see „3.4.7 Button (only room controller)“.

- Display --> General --> Access level, local operation

No access

This selection should be made so that the user (e.g. the hotel guest) cannot inadvertently change the device settings. Programming mode and the product information can be accessed by pressing and holding down (>30 s) the button in the middle.

- KNX thermostat --> General --> Fan available

Tick box --> The display page for controlling the fan can be called up

- KNX thermostat --> Basic heating or basic cooling --> Fan also serves to heat/cool the room

Tick box --> Automatic fan control can be selected

i Before enabling the Hotel mode function, check that the "Access level" parameter has been set to "NO ACCESS".

Display → General → Access level

Application description

KNX thermostat

KNX room controller



- i** This Hotel mode function is only available in the device variant KNX thermostat as of firmware 1.1.5.

Adjusting the set temperature

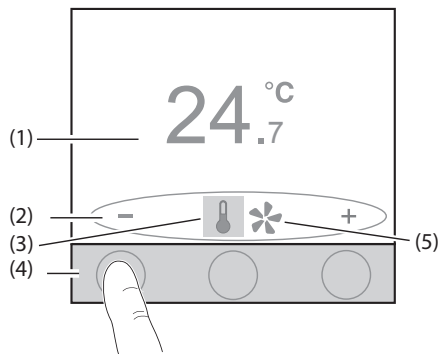

- Press the touch surface underneath the + / - symbols
Temperature setpoint is increased resp. reduced.
(1) Current temperature setpoint
(2) Function symbols for the touch control surface
(3) Change temperature setpoint active
(4) Touch-sensitive control surface (press)
(5) Change fan speed not active

Adjusting the fan speeds

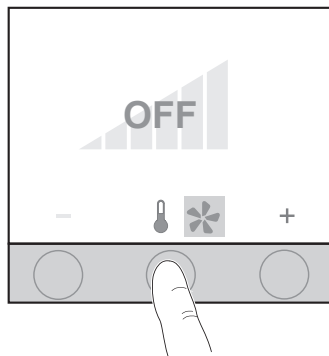

- Press the touch surface in the middle underneath the
🌡️ / 🌀 symbols.
Change the setting mode from temperature setpoint
change to fan speed change (5).
- f** This function will only be available if the "Fan available"
function has been activated upstream.

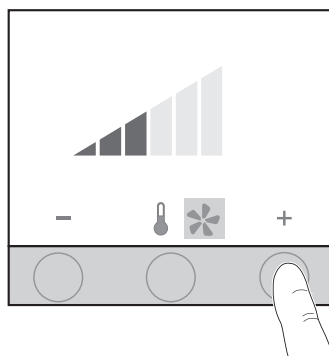

- Press the touch surface underneath the + / - symbols
Fan speed is increased resp. reduced.
Up to 6 fan speeds can be set.

Application description

KNX thermostat

KNX room controller

Activating fan speed automatic mode

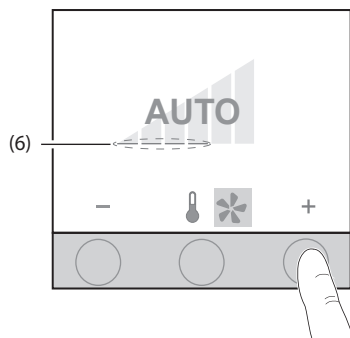

- Press the touch surface underneath the + symbol until AUTO appears.
Automatic mode is activated.
The fan speed (6) is displayed below AUTO.
Manual mode is deactivated.
- Automatic mode is only active if the fan is being used for heating and/or cooling.

Deactivating fan speed automatic mode

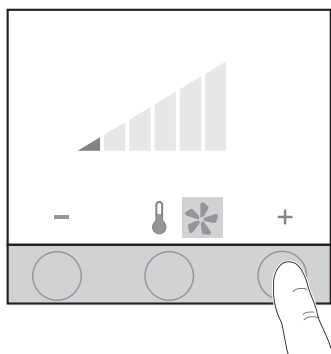

Fan is in automatic mode (e.g. step 4).

- Press the touch surface underneath the + symbol
Automatic mode is deactivated.
Fan speed is increased by one step.
- Press the touch surface underneath the - symbol
Automatic mode is deactivated.
Fan speed is reduced by one step.

Switching off fan

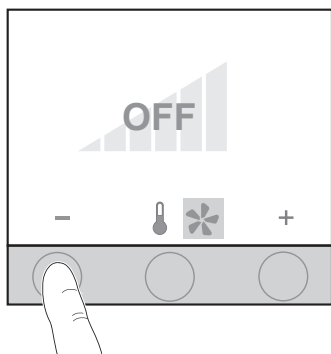

- Press the touch surface underneath the - symbol until **OFF** appears.
The fan is then switched off.

The parameters changed by the user (e.g. temperature setpoint and fan speed) can be restored to their original settings via the corresponding communication objects.

The commands can be sent using a touch display, for example.

- Press and hold down (>10 s) the touch surface in the middle to activate the "Menu setting". This function is exited again automatically if the device is not operated – **Wait time** (Display --> General --> Action if no operation --> Wait time).

* Default value

3.4.1 General

In the general display settings, you have to set the parameters brightness during daytime or night operation, action if device not operated, authorisation for local operation and choice of device language.

The screen brightness can be adjusted for daytime and nighttime operation.

In the parameter "Action if product not operated after set time", the behaviour is defined that should be displayed or should occur after a selectable time has elapsed.

The settings to "NO ACCESS" in the "access level" parameter must be made in public areas in order to prevent adjustments of the default setting.

i If installed in public areas, such as schools, office buildings, administrative buildings, particular attention should be paid to this parameter in order to avoid unintended use.

i In private areas, this function can be regarded as child safety device.

Furthermore, the language must be chosen for the display texts.

Display → General

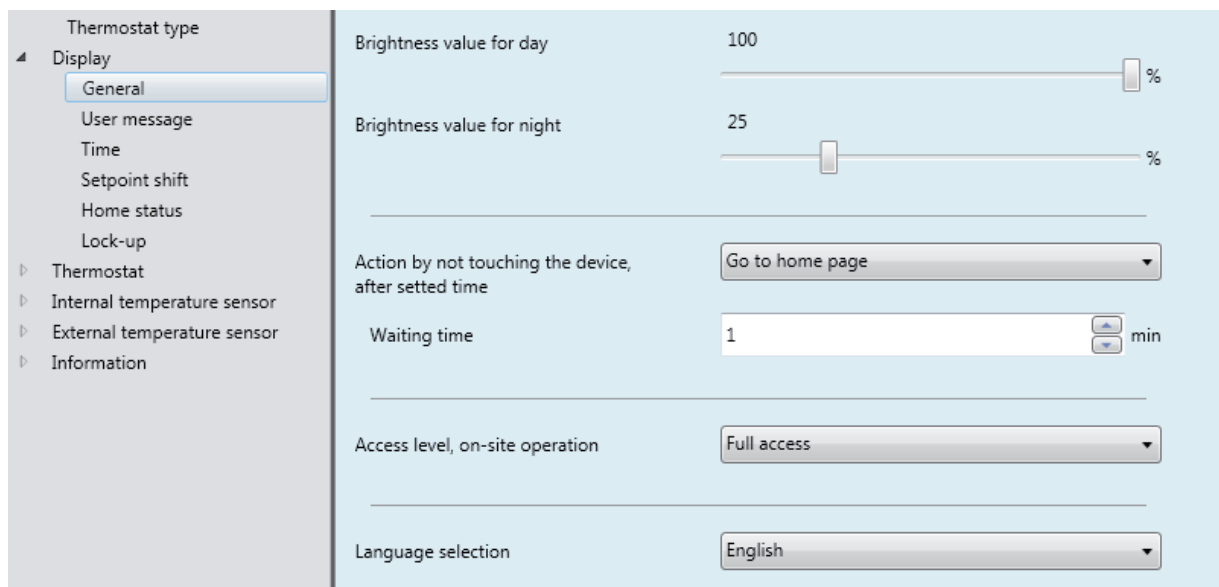

Figure 6: General settings

Parameter	Description	Value
Brightness value daytime operation	The display brightness for daytime operation is set with this parameter.	Day 0 ... 100 % *
Brightness value nighttime operation	The display brightness for nighttime operation is set with this parameter.	Night 0 ... 25% *... 100 %
Action after set waiting time if product is not operated	With this parameter you can set which information the device should display or which action should be performed once the waiting time has elapsed.	No change Go to start page * Go to start page + switch the display off Go to start page + set screen brightness to night mode Go to start page + screen saver
Waiting time	The parameter defines after which time period the device should change to the above mode.	1 min * ... 255 min

Screen saver 1	Here the screen saver type can be set.	Analogue clock * Digital clock Logo Outside temperature + time Room temperature + time Operation help
Access level, local operation	Here, you can set the access authorisation for the device. This parameter is useful in public areas, in which certain device settings are disabled.	Full access * Limited access No access
Choice of language	This parameter presets the device language.	English* , French, German, Italian, Portuguese, Spanish, Dutch, Swedish, Danish, Finnish, Norwegian, Turkish, Polish

Table 4: General Settings

1 This parameter is only visible when selecting "Go to start page + screen saver".

Full access

This setting gives the user full access to the parameter settings that can be adjusted on the device.

Limited access

This setting gives the user limited access to the parameter settings that can be adjusted on the device.

No access

This setting gives the user no access to the parameter settings that can be adjusted on the device. For example, only holiday mode can be switched on, but not the number of days.

* Default value

Display → User messages

Thermostat type	User text message 1 (max. 20 characters)	Message 1
– Display	Polarity	<input type="radio"/> ON = 0 <input checked="" type="radio"/> ON = 1
General	User text message 2 (max. 20 characters)	Message 2
User message	Polarity	<input type="radio"/> ON = 0 <input checked="" type="radio"/> ON = 1
Time	User text message 3 (max. 20 characters)	Message 3
Setpoint shift	Polarity	<input type="radio"/> ON = 0 <input checked="" type="radio"/> ON = 1
Home status	Polarity of reset the alarm message	<input type="radio"/> ON = 0 <input checked="" type="radio"/> ON = 1
Lock-up		

Figure 7: User messages

Parameter	Description	Value
Predefined text message x 1 (max. 20 characters)	This parameter allows you to create a predefined text message with a max. of 20 characters.	Free text x *
Polarity	This setting defines at which value 0/1 the predefined text message is displayed on the corresponding object.	ON = 1* ON = 0
Polarity Reset alarm message	This parameter defines at which value the alarm message is reset on the object.	ON = 1* ON = 0

Table 5: User messages

Communication objects "User messages"

No.	Name	Object function	Length	Datentyp
3	Display	Predefined text message 1	1bit	1.001 DPT_ON/OFF
4	Display	Predefined text message 2	1bit	1.001 DPT_ON/OFF
5	Display	Predefined text message 3	1bit	1.001 DPT_ON/OFF
6	Display	Alarm message	14 byte	16.000 DPT_Character(ASCII)
7	Display	Reset alarm message	1bit	1.015 DPT_Reset

1 A maximum of three messages can be displayed (x = 1;2;3).

The predefined text messages appear on the "Status" page.

* Default value

Application description

KNX thermostat

KNX room controller

3.4.3 Time



The settings for the time signal (internal or external), change to daylight serving time and time format can be set in this section. The time signal can either be set manually in the display or received via an external source.

Display → Time

Figure 8: Time

Parameter	Description	Value
Time	With this parameter you choose whether the time is set and started on the display or whether the time signal should be received from an external source (e.g. weather station). ¹	Internal * External
Change to daylight serving time ²	This parameter defines the setting for the summer/wintertime changeover for the respective operating location.	Manual operation Europe summer/wintertime changeover * USA summer/wintertime changeover Australian summer/wintertime changeover
Time format	This parameter sets the time display in the time format appropriate for the operating location.	12h (AM/PM) 24 h *

Table 6: Time

The devices receive the time signal e.g. from a weather station or timer. Two separate communication objects are available for this purpose.

No.	Name	Object function	Length	Datentyp
91	Date and time	Date	3 bytes	11.001 DPT_Date
92	Date and time	Time	3 bytes	10.001 DPT_Daytime
93	Date and time	Date and time	8 byte	19.001 DPT_Date/Time
94	Date and time	Date and time	1bit	1.017 DPT_Trigger

¹ The time signal is generated in the device by a built-in clock. The clock has a power reserve of approx. 4 hours.

² The change to daylight serving time can only be set if the "Internal (Default value)" value is selected. If the "External" value is set, the summer/winter time is changed automatically by the received time signal.

The communication objects, 91 to 94, are only visible if the time is set to "External" in the parameter branch "Display - time".

* Default value

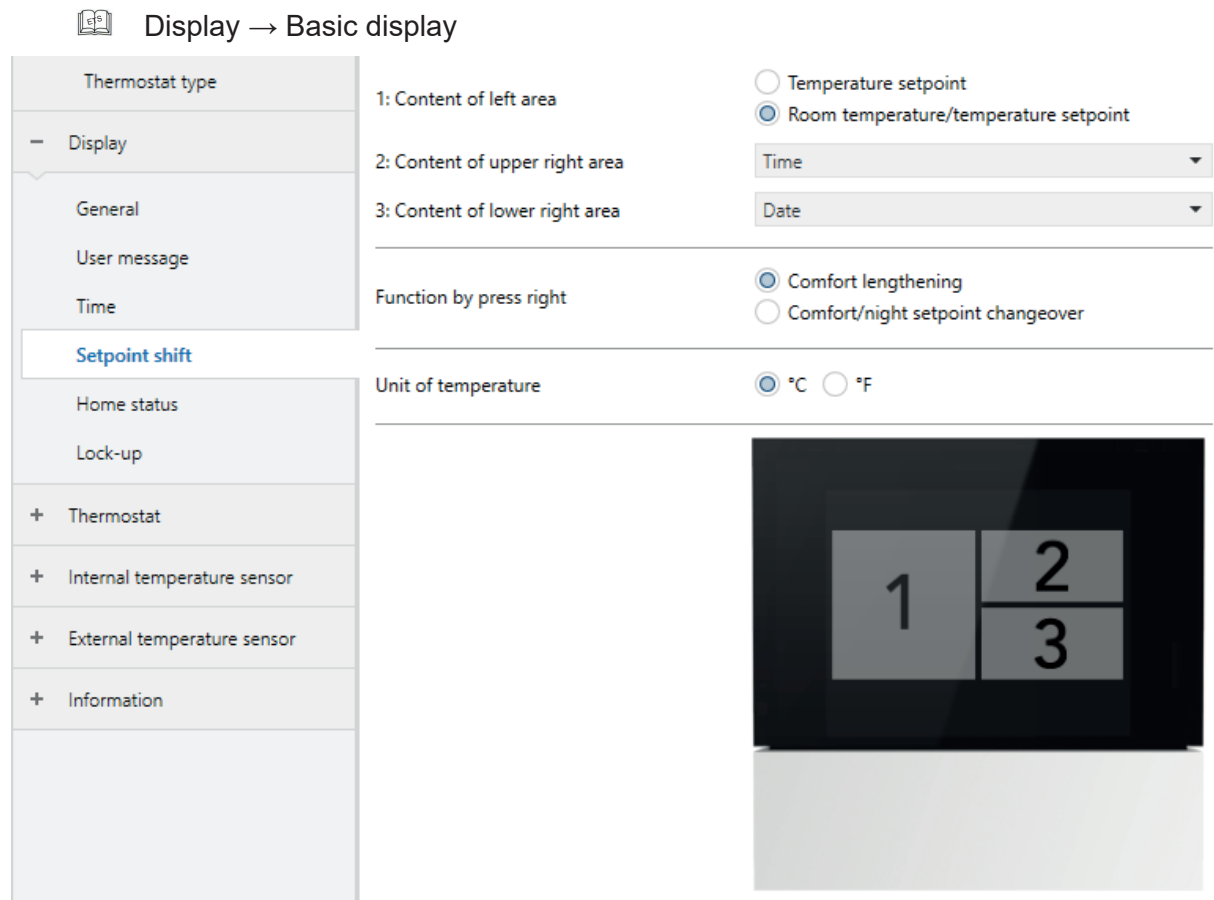

Figure 9: Basic display

Parameter	Description	Value
1: Content of the left surface	This parameter sets which value is to be shown on the left display area	Room temperature/Set temperature * Set temperature
2: Content, top right	This parameter sets which value is to be shown on the page "Basic display" on top right	Nothing Date * Time Outside temperature Set temperature
3: Content, bottom right	This parameter sets which value is to be shown on the page "Basic display" on bottom right	Nothing Date * Time Outside temperature Set temperature
Page basic display: Function on right button	This parameter sets which functions should be toggled between when pressing the right button.	Comfort extension* Change-over Comfort/Night-time Temperature Reduction
Temperature unit	The temperature unit is set with this parameter.	°C * °F A conversion aid can be found in the ETS under "room temperature → setpoints"

Table 7: Page "Basic display"

* Default value

Application description

KNX thermostat

KNX room controller

3.4.5 State of the house

In the "State of the house" function, a data value can be displayed as text on the "Status" display page, such as CO2 value and temperature.

These settings are linked to the "Status" display page.

 Display → State of the house

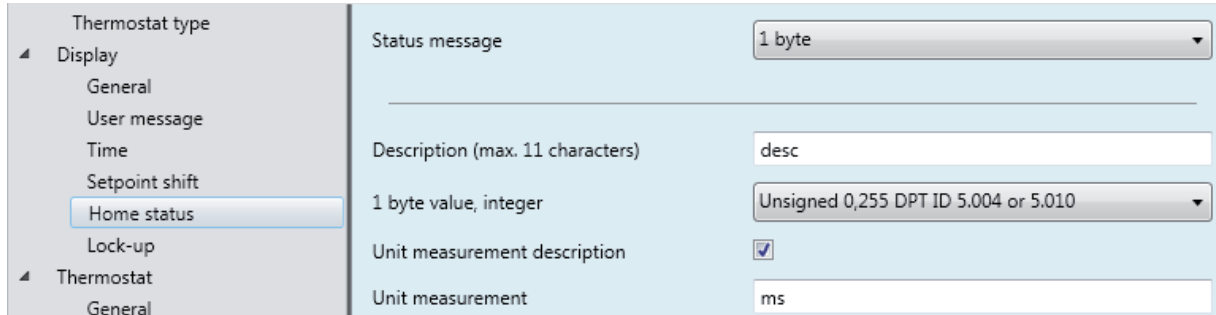

The screenshot shows the configuration page for the 'State of the house' function. On the left is a navigation menu with categories: Thermostat type, Display (General, User message, Time, Setpoint shift, Home status), Lock-up, and Thermostat (General). The 'Home status' option is selected. The main configuration area includes: 'Status message' set to '1 byte'; 'Description (max. 11 characters)' set to 'desc'; '1 byte value, integer' set to 'Unsigned 0,255 DPT ID 5.004 or 5.010'; 'Unit measurement description' checked; and 'Unit measurement' set to 'ms'.

Figure 10: State of the house

Parameter	Description	Value
Status message	This setting defines which data type, value should be displayed as a status message.	Inactive* Value 1 bit Value 1 byte Value 2 bytes Value 4 bytes
■ Status value 1 bit switching		
Message if 0	In this parameter, a free text (a maximum of 20 characters) can be entered, which is displayed if a "0" is received.	Free text (a maximum of 20 characters)
Message if 1	In this parameter, a free text (a maximum of 20 characters) can be entered, which is displayed if a "1" is received.	Free text (a maximum of 20 characters)

■ Status value 1 byte		
Description	In this parameter, a free text (a maximum of 11 characters) can be entered	Free text (a maximum of 11 characters)
1 Byte value, integer	The data type format of the value to be displayed is defined with this parameter.	Value 0 ... 255 * Value 0 ... 100 % Value 0 ... 360 ° Value -127 ... +128
Measuring unit 1	In this parameter, a text not exceeding 3 characters in length can be entered as a measuring unit.	e.g. ms, kWh, ppm, lux, °, % (a max. of 3 characters)
■ Status value 2 byte		
Description	In this parameter, a free text (a maximum of 11 characters) can be entered	Free text (a maximum of 11 characters)
Number format	The format of the numerical values to be displayed is defined with this parameter.	Integer * Floating-point number
2-Byte value, integer	The data type format of the value to be displayed is defined with this parameter.	0 ... 65535 * -32768 ... 32767
Decimal places ²	If the value "floating-point number" is selected, the number of decimal places must be set in this parameter.	0 *... 2
Measuring unit 1	In this parameter, a text not exceeding 3 characters in length can be entered as a measuring unit.	e.g. ms, kWh, ppm, lux, °, % (a max. of 3 characters)
■ Status value 4-byte		
Description	In this parameter, a free text (a maximum of 6 characters) can be entered	Free text (a maximum of 6 characters)
Number format	The format of the numerical values to be displayed is defined with this parameter.	Integer * Floating-point number
4-Byte value, integer	The data type format of the value to be displayed is defined with this parameter.	0 ... 4294967295 * -2147483648 ... 2147483647
Decimal places ²	If the value "floating-point number" is selected, the number of decimal places must be set in this parameter.	0 *.. 2
Measuring unit 1	In this parameter, a text not exceeding 3 characters in length can be entered as a measuring unit.	e.g. ms, kWh, ppm, lux, °, % (a max. of 3 characters)

Table 8: State of the house



In the Table 10 auf Seite 22, examples must be listed for individual status value types.

No.	Name	Object function	Length	Datentyp
9	Display	1bit	1bit	1.001 DPT_ON/OFF
10	Display	1 byte	1 byte	7.001 DPT_Counting pulse (0..255)
11	Display	2 byte	2 byte	7.001 DPT_Pulse
12	Display	4 byte	4 byte	12.001DPT_Counting pulses (unsigned)

¹ This parameter is visible if the checkmark for "Description of the measuring unit" is checked.

² This parameter is visible if the number format "floating-point number" is selected under value "2 or 4 byte".

* Default value

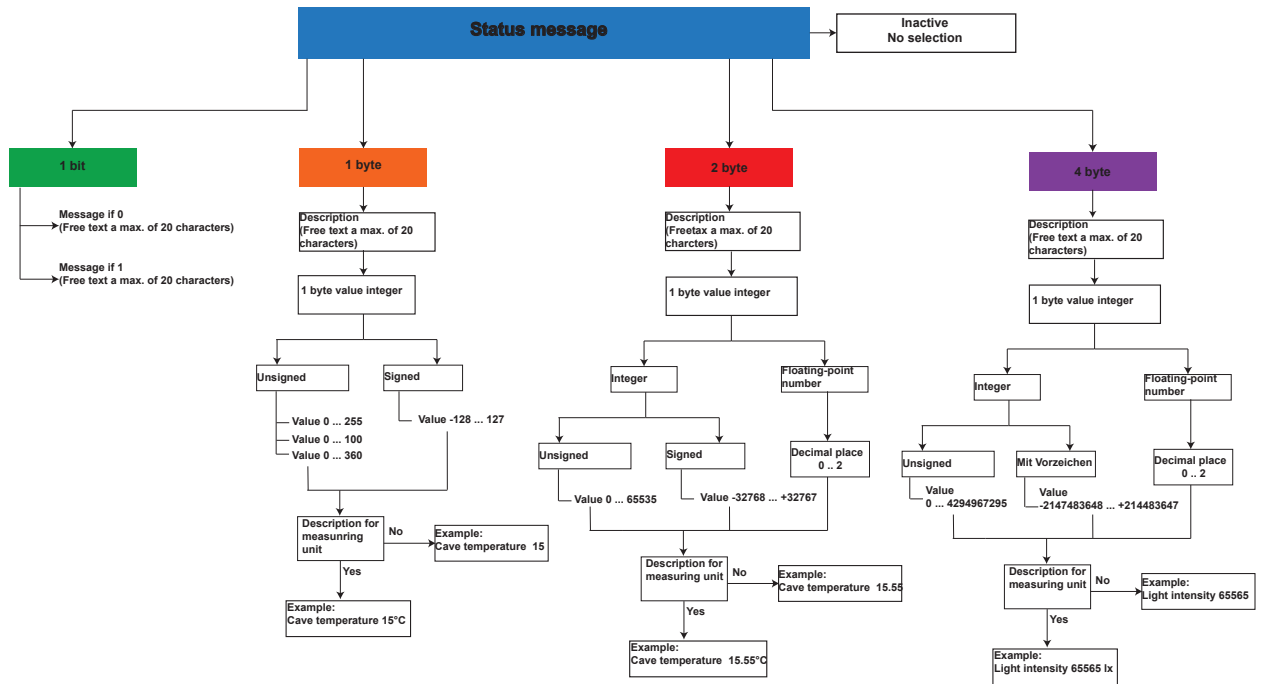

Figure 11: Overview “Configuration status message”

Status - messages

The state of the house can be displayed on the "Status" page. These status messages can be freely parameterised in the ETS. Messages can also be displayed via window contact query, overload, alarm messages and predefined user messages.

On the "Status" display page, a maximum of 3 status/user messages can be displayed simultaneously. The messages are displayed here by means of the priority list (Table 46).

Priority	Description
Priority 1 (highest priority)	State of the house (object 11)
Priority 2	Window open/close (object 22)
Priority 3	Overload (object 23)
Priority 4	Alarm message (object 6)
Priority 5	User message 1 (object 3)
Priority 6	User message 2 (object 4)
Priority 7 (lowest priority)	User message 3 (object 5)

Table 9: Priority Status message/User message

Status messages				
	1-Bit switching	1-Byte value	2-byte value	4-byte value
Example	Frontdoor open	TV 100 W	Cooker 2.4 kWh	Light 200000 Lx
Description	Frontdoor open	TV	Cooker	Light
Value	---	100	2.4	20000
Decimal place	---	---	1	0
Measuring unit	---	W	kWh	lx

Table 10: Examples Status messages

Application description

KNX thermostat

KNX room controller

3.4.6 Blocking function



In the following parameter window, the respective function and selection options of the "Blocking function" function are displayed

In addition, the push-buttons 1-9 can be blocked for which the "blocking function" checkmark within the parameters of the "button x" must also be checked. If the blocking function is activated, the lock symbol appears in the display on all pages affected.

Display → Blocking function

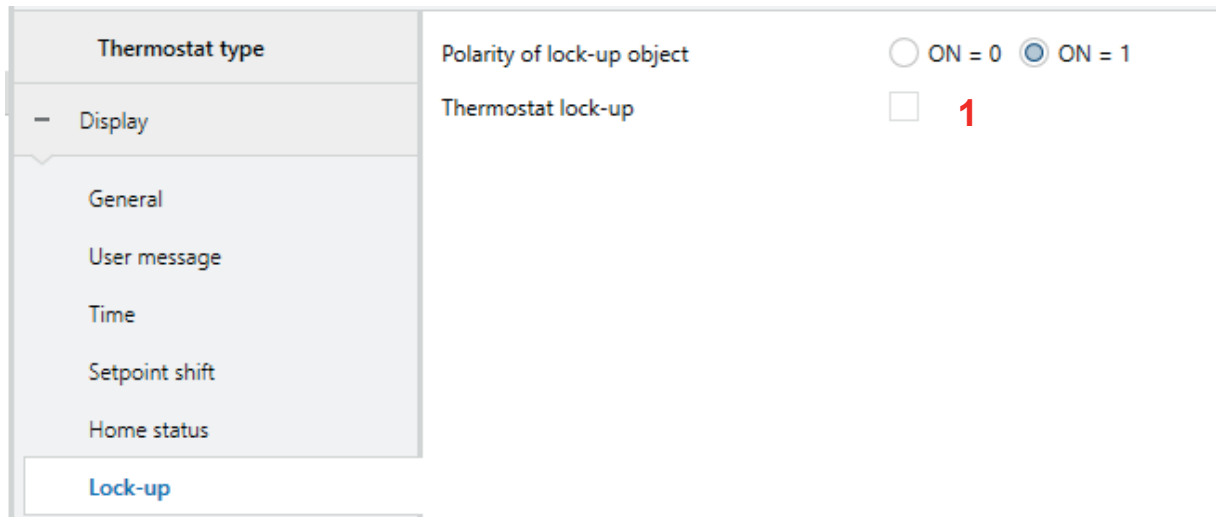

Figure 12: Blocking function

Parameter	Description	Value
Polarity of lock-up object	This parameter defines at what value the blocking function is activated.	ON = 1* ON = 0

It is possible to lock all pages of the products by which the temperature control can be set or changed. To do this, the checkmark for "Block temperature control" (Figure 12,1) must be checked and the blocking function enabled via the object 8.

Table 11: Blocking function

Communication object "Blocking function"

No.	Name	Object function	Length	Datentyp
8	Display	Blocking function	1bit	1.001 DPT_ON/OFF

After bus voltage recovery, a lock-up remains active if it was activated before the bus voltage failed.

The polarity of the lock-up object can be parameterised.

* Default value

Application description

KNX thermostat

KNX room controller

3.4.7 Button (only room controller)



i The following parameter setting can only be selected on the device "KNX Room controller". A long push-button action, among other things, is required for the functions "Dimming (brighter/darker), shutter/blind (up/down) set temperature adjustment etc.

Display → Button

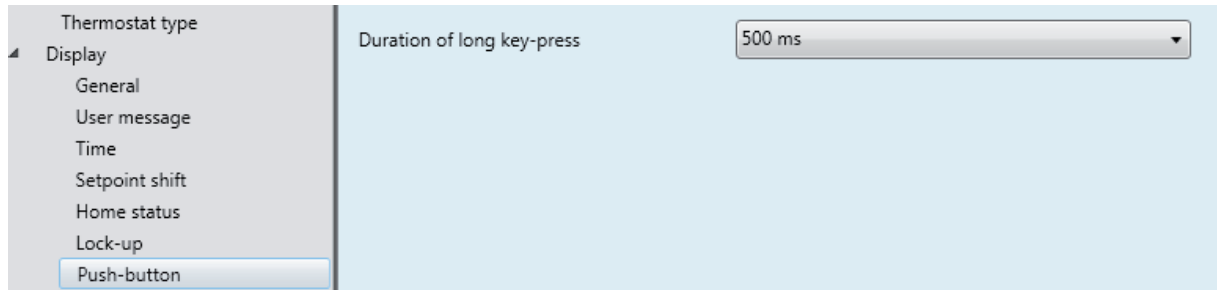

Figure 13: Time setting for long push-button action

Parameter	Description	Value
Time for long button-press	This parameter defines the moment from when a long push-button action is detected.	400 ms ... 500 ms *... 1s;

Table 12: Time setting for long push-button action

* Default value

In this section, the settings for the thermostat functions will be presented. Here, for example, the parameters of the heating system (convector heating, underfloor heating etc.) or the temperature setpoints for heating and/or cooling are set.

3.5.1 General

The parameter settings for the Room thermostat - General are to be set the same for both device variants (thermostat/room controller).

The function distinguishes between the operating modes "heating" and "cooling". The operating modes define whether the controller should control heating systems or cooling systems via its parameters. A mixed operation of heating and cooling is also possible, whereby the device controlled automatically via communication objects, switches between the heating and cooling operating modes.

Furthermore, the device has additional heating or cooling stages. With this two-stage control, separate command values are calculated and transmitted for the basic and additional stage depending on the set/actual temperature deviation.

Room thermostat → General → Operating mode

In the general settings, the operating mode of the heating and/or cooling system must first be set. The six different operating modes are shown in the following overview.

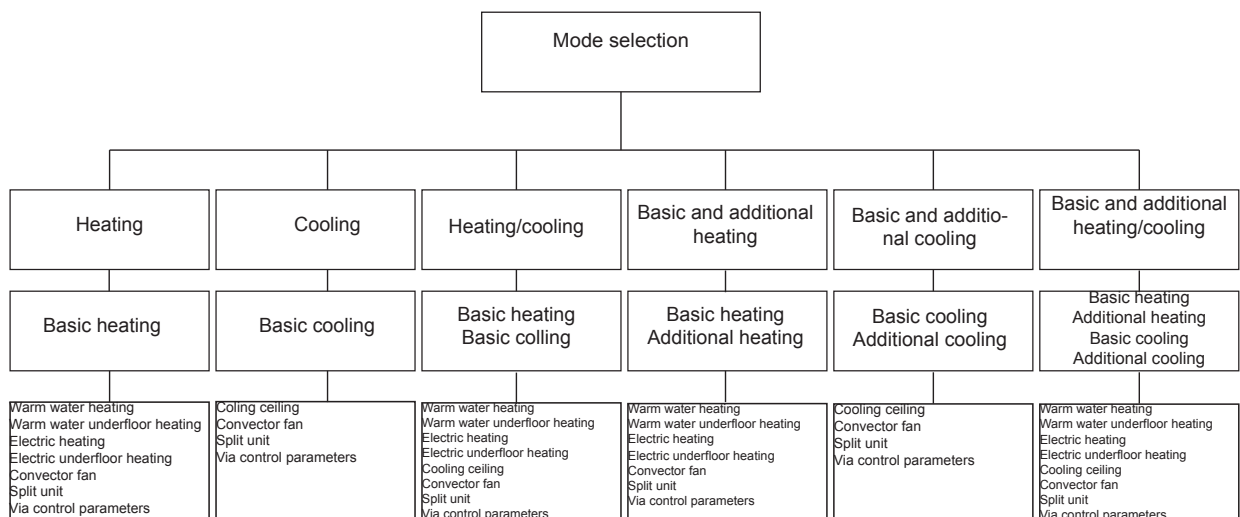

Figure 14: Overview heating/cooling variants

The corresponding parameter windows for configuration open depending on operating mode. Furthermore, the general settings, such as operating mode changeover, frost/heat protection, valve protection, presence detection, holiday mode and self-learning heating curve, have to be made.

Thermostat type	Function selection	Basic and additional heating and cooling
+ Display	Ventilation available	<input checked="" type="checkbox"/> 1
- Thermostat	Emission valve position heating and cooling to one common object	<input checked="" type="checkbox"/> 2
General	Status after reset	Comfort
Basic heating	Mode selection	Through value (1 byte)
Additional heating	Frost/heat protection	<input type="radio"/> Automatic frost/heat protection <input checked="" type="radio"/> Through windows contact
Basic cooling	Frost/heat protection changeover switching delay	5 min
Additional cooling	Heating/Cooling - changeover	<input type="radio"/> Automatic <input checked="" type="radio"/> Through object
Temperature measurement	Heat/cool mode after reset	Operating mode before reset
Ventilation	Periodical emission delay heating/cooling status	0 min
Emission settings	Thermostat deactivation	<input type="radio"/> Through object <input checked="" type="radio"/> No
Setpoints	Lock-up additional step	<input type="radio"/> Through object <input checked="" type="radio"/> No
Setpoint shift	Valve protection	<input checked="" type="checkbox"/> 3
Scene	Time of day	0 h
+ Internal temperature sensor	Presence detection	Through presence push-button
+ External temperature sensor	Comfort lengthening time	30 min
+ Information	Holiday mode - operating mode selection	Holiday mode - Frost/heat protection
	Limited to 99 days for firmware below 1.1.5	
	Holiday mode - Number of days	1
	Self-learning heating curve	<input type="checkbox"/> 4

Figure 15: Settings “General - room thermostat”

Parameter	Description	Value
Operating mode ¹	The operating mode of the heating/cooling system is defined with this parameter.	Heating * Cooling Heating/Cooling Basic and additional heating Basic and additional cooling Basic and additional heating/cooling
Fan available	After activating the parameter (set checkmark), an additional parameter "Ventilation" becomes visible (Figure 15, 1). The settings for the ventilation are made in this parameter.	
Send heating and cooling command value to a common object ²	When using this parameter (checkmark is enabled by default (Figure 15, 2)), it is possible to transmit the "Heating/Cooling" command value to the bus as a common communication object.	
Status after reset	This parameter defines the operating mode which is to be switched on after a reset.	Comfort * Standby Night operation Frost/Heat protection State before failure
Operating mode changeover	This parameter defines the communication object type with which the change-over of the operating mode should take place.	Via value 1 byte * Via switching (4 x 1 bit) Via value (1 byte) and/or via switching (4 x 1 bit)
Frost/heat protection	This parameter defines what triggers the frost/heat protection.	Automatic Frost/Heat protection Via window contact *

Application description

KNX thermostat

KNX room controller



Frost/heat protection change-over delay	The change-over delay allows you to set the delay time that must elapse before the frost/heat protection mode is activated.	0 *... 255 min
Automatic Frost/Heat protection 3	The automatic frost/heat protection change-over sets the temperature change at which the change-over to frost/heat protection should take place per minute.	Off * 0.2 K/min ... 0.6 K/min
Heating/Cooling - changeover	This parameter allows you to set how the change-over between heating and cooling should occur.	Via object * Automatic
Heating/Cooling operation after bus voltage failure	The operating mode that the heating/cooling system is set to after a rest or after a bus voltage failure is set here.	Heating Cooling Operating mode before reset *
Time for periodical transmission heating/cooling state	The cycle time at the end of which the heating/cooling state is sent is set here.	0 * ... 255 min

Table 13: Settings “General - room thermostat”

1 Depending on the value selection in the "operating mode" parameter, additional function parameters are shown for configuring the heating and/or cooling system.

2 This parameter is only visible if the values "heating and cooling" or heating and cooling plus additional stages" are selected in the "operating mode" parameter.

3 This parameter is only visible if the value "Automatic Frost/Heat protection" is selected in the "Frost/Heat protection" parameter.

No.	Name	Object function	Length	Datentyp
13	Room thermostat	Operating mode changeover	1 byte	20.102 DPT_HVAC mode
14	Room thermostat	Comfort	1bit	1.001 DPT_ON/OFF
15	Room thermostat	Standby	1bit	1.001 DPT_ON/OFF
16	Room thermostat	Night lowering	1bit	1.001 DPT_ON/OFF
17	Room thermostat	Frost/heat protection	1bit	1.001 DPT_ON/OFF
18	Room thermostat	Operating mode changeover Automatic	1 byte	20.102 DPT_HVAC mode
22	Room thermostat	Window contact state	1bit	1.019 DPT_Window/Door
86	Room thermostat	Presence	1 bits	1.001 DPT_ON/OFF
87	Room thermostat	Deactivation room thermostat	1bit	1.003 DPT_Enable

* Default value

Parameter	Description	Value
Deactivation room thermostat	With this parameter it is possible to stop the temperature control via object.	No * Via object
Polarity 4	This setting defines from which value 0/1 the deactivation takes place on the corresponding object.	On = 0* On = 1 *
Lock-up of additional stage	With this parameter it is possible to deactivate the thermostat.	No * Via object
Polarity 5	This setting defines from which value 0/1 the deactivation takes place on the corresponding object.	On = 0* On = 1 *
Valve protection (further explanations on next page)	(Checkmark is disabled by default (Figure 15, 3)) This parameter is used, for example, to prevent calcification of the radiator valve.	
Daytime 6	This parameter sets the time when the valve protection should be performed.	0 * ... 23 h
Presence detection (further explanations on next page)	This parameter allows you to set the way in which the comfort extension can be switched to.	Inactive Using presence button* Using presence detector
Comfort extension time	If "Using presence button or Using presence detector" is selected, the comfort extension time can be set here.	Inactive 1 s... 30 min * ... 24 h
Holiday mode - Selecting operating mode	The operating mode for holiday mode is selected with this parameter.	Holiday mode - Frost/Heat protection * Holiday mode standby Holiday mode night lowering
Holiday mode - Number of days	The number of holidays is set with this parameter. If holiday mode is activated, the thermostat runs the heating/cooling system in the holiday operating mode previously selected for the selected period.	1 * ... 99 1 * ... 255 as of firmware 1.1.5
Self-learning heating curve (further explanations on next page)	(Checkmark is enabled by default (Figure 15, 4)) This parameter is used to set the room thermostat to a self-learning mode.	

Table 14: Settings "General - Room thermostat - Heating"

- 4 This parameter is only visible if the value "Via object" is selected "in the parameter "deactivation of thermostat".
 5 This parameter is only visible if the value "Via object" is selected "in the parameter "Lock-up of additional stage".
 6 This parameter is only visible if the checkmark is set to valve protection.

* Default value

Application description

KNX thermostat

KNX room controller

Valve protection



To prevent calcification or jamming of the activated radiator or cooling system control valves, a cyclical valve protection can be performed. The "valve protection" parameter in the parameter branch "General - Room thermostat" is deactivated by default (set checkmark Figure 15, 3).

This protection function is generally only started for inactive command value outputs, i.e. for outputs that have not requested any heating or cooling energy in the past 24 hours. The controller sets the command value for these outputs to the maximum value cyclically once a day at the selected hour for a period of approx. 5 minutes. Consequently, even valves that have been closed over long periods are briefly opened at regular intervals.

Presence detection

In order to activate the comfort extension, the presence button or presence detector can be activated additionally by the "presence detection" parameter. If activated, the "Room thermostat - presence" object appears. In this way, it is possible to switch to the comfort extension or to deactivate this again early by pressing the presence button through a presence detector activity.

Self-learning heating curve

If the checkmark is set (Figure 15, 4), the thermostat "learns" how long the lead time must be in order to reach the set room temperature at the respective time.

The "self-learning mode" may take some time depending on the heating/cooling habits.

3.5.2 Operating mode

The room temperature controller distinguishes various operating modes. Thus, for example, it is possible to activate different temperature setpoints depending on the presence of a person, the state of the heating or cooling system, depending on the the time of day or weekday by activating these modes.

Comfort operation

The comfort operating mode should be activated if people are in a room and for this reason the room temperature must be adjusted to a comfortable, appropriate value. The change-over to this operating mode can also be presence-controlled. An activated comfort operating mode is indicated in the display by the  symbol.

Standby operation

If a room is not used during the day because people are absent, the standby operation can be activated. Thus, the room temperature can be adjusted to a standby value and heating and cooling energy can be saved. An activated standby operating mode is indicated in the display by the  symbol.

Night operation

During nighttime hours or in cases of prolonged absence, it is usually advisable to adjust the room temperature (e.g. in bedrooms) of heating systems to cooler temperatures. In this case, cooling systems can be set to higher temperature values if an air-conditioning system is not necessary (e.g. in offices). The night operation can be activated for this purpose. An activated night operation is indicated in the display by the  symbol.

Frost/heat protection mode

Frost protection is necessary if, for example, the room temperature must not fall below a critical value when the window is open. Heat protection may be necessary if the temperature becomes too high (mostly due to external influences of a constantly warm environment). In these cases, freezing or overheating of the room depending on the set operating mode "Cooling" or "Heating" can be prevented by activating the frost/heat protection or by specifying a separate temperature setpoint.

Application description

KNX thermostat

KNX room controller



An activated frost/heat protection is indicated in the display by the symbol " / ".

Comfort extension (temporary comfort operation)

The comfort extension can be used to adjust the room to the comfort temperature for a certain time, for example, if the room is also 'used' during the night. Activation takes place by a parameterised presence button on the "basic display" page or by the presence object. The comfort extension is deactivated automatically once a definable time has elapsed by pressing the presence button again or by receiving a presence object value = "0". The extension cannot be triggered.

An activated comfort extension is indicated in the display by the  symbol.

A separate temperature setpoint can be predefined for each "Heating" or "Cooling" operating mode.

3.5.2.1 Operating mode changeover

The operating modes can be activated or changed over in various ways.

- an operation locally on the device using the touch control surface
- a switching time set locally on the device (timer)
- the communication objects available separately for each operating mode

An activation or change-over is possible by (with descending priority):

1. Deactivation room thermostat via object → Frost/Heat protection is activated
2. Priority function object (2-bit) → forced mode comfort or frost/heat protection
3. Window contact → Automatic Frost/Heat protection
4. Holiday mode → Frost/Heat protection, night lowering, standby
5. Operating mode changeover on display
6. Switch operating mode via object no. 13 - 18
7. Comfort extension via presence object/button.

The individual options for the operating mode changeover are described in detail below.

Using the touch-sensitive control surface to change over the operating mode

The "Comfort", "Standby" or "Night lowering" operating modes can be activated using the touch-sensitive control surface on the "Operating mode" page. The selected operating mode can be activated and set on the "Holiday mode" page.

Change-over of the operating mode via the internal timer

The switch-on or switch-off times can be set on the "Timer" page for the operating modes "comfort", "standby" or "night operation". The switching times can optionally be parameterised for each weekday or for sections of the week.

 The timer can be set only on the device.

Change-over of the operating mode via communication objects

A distinction is made as to whether the operating mode change-over should take place via separate 1-byte objects, four 1-bit objects or alternatively via the 1-byte and/or four 1-bit objects. The "operating mode changeover" parameter in the "Room thermostat - General" parameter branch defines the change-over method.

The operating mode change-over via "Switching" (4 x 1 bit):

There is a separate 1-bit change-over object for each operating mode. It is possible to changeover or specify the current operating mode through each of these objects depending on priority.

Application description

KNX thermostat

KNX room controller



Taking the priority into account results in the following changeover hierarchy during an operating mode change-over whereby a distinction is made between presence detection by a presence button (Table 15/Figure 16) and a presence detector (Table 16/Figure 17):

Objects operating mode change-over				Window status	Presence button object	Active operating-mode
X	X	X	X	1	X	Frost/heat protection
1	X	X	X	0	0	Frost/heat protection
0	1	X	X	0	0	Comfort
0	0	1	X	0	0	Standby
0	0	0	1	0	0	Night operation
1	X	X	X	0	1	Comfort extension
0	1	X	X	0	1	Comfort
0	0	1	X	0	1	Comfort
0	0	0	1	0	1	Comfort extension
0	0	0	0	0	0	Last valid mode set
0	0	0	0	0	1	Comfort/Comfort extension

Table 15: Operating mode change-over via object with presence object

X = irrelevant

*: Depending on the last valid operating mode set

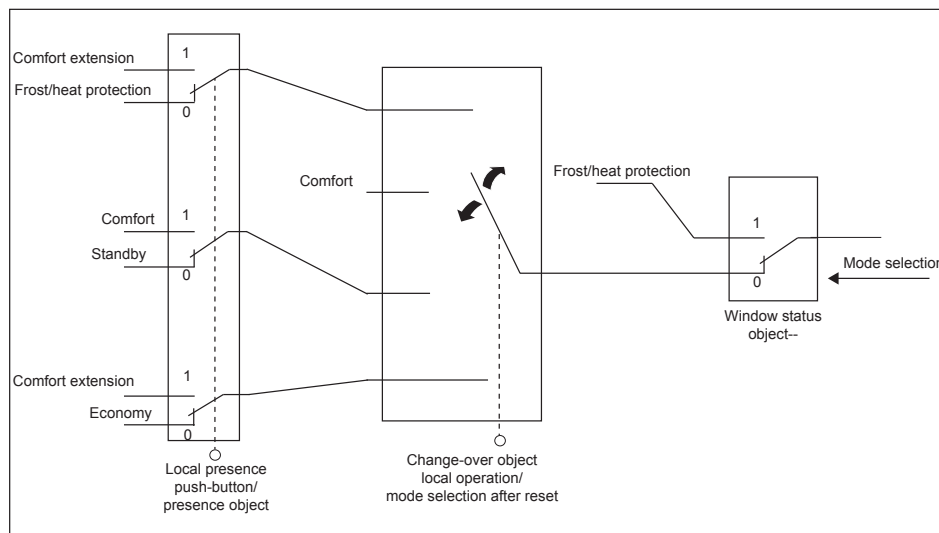

Figure 16: Overview diagram "Operating mode change-over via object with presence object" (4x1 bit)

Objects operating mode change-over				Window status	Presence detector object	Active operating mode
X	X	X	X	1	X	Frost/heat protection
X	X	X	X	0	1	Comfort
1	X	X	X	0	0	Frost/heat protection
0	1	X	X	0	0	Comfort
0	0	1	X	0	0	Standby
0	0	0	1	0	0	Night operation
0	0	0	0	0	0	Last valid mode set

Table 16: Operating mode change-over via object with presence object with presence detector

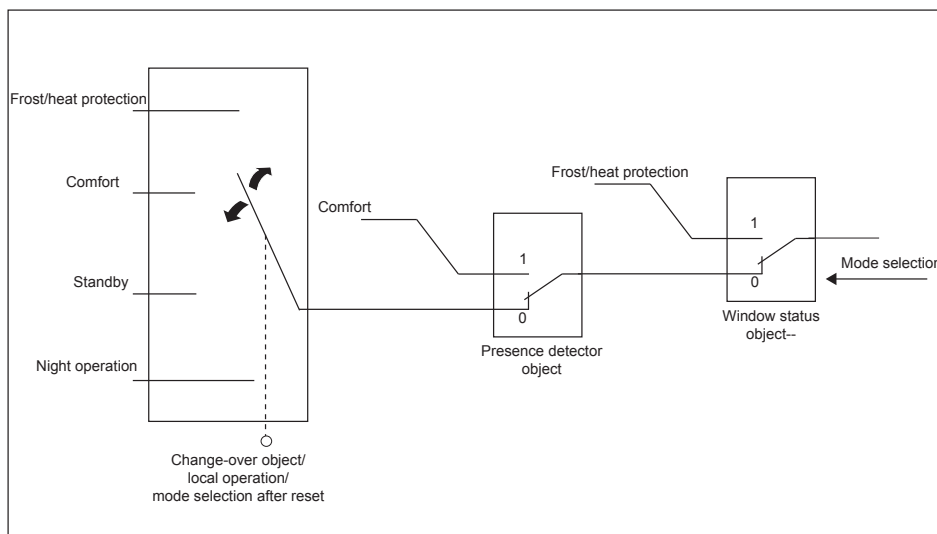

Figure 17: Overview diagram "Operating mode change-over via object with presence detector" (4x1bit)

Operating mode change-over via "Value" (1 byte)

There are two common 1-byte change-over objects for all operating modes, namely no. 13 and 18. A command for changing over the operating mode, e.g. from a central clock, is sent to the object no. 18. At the same time, the operating mode can be changed via the object no. 13, e.g. by a push-button. During running time, the change-over of the operating mode can take place immediately via this value object after receipt of just one telegram. In the course of this, the received value defines the operating mode.

1-Byte object operating mode change-over	2-Bit priority object Operating mode	Window status	Presence button object	Active operating mode
X	0 1	X	X	Comfort
X	1 1	X	X	Frost/heat protection
01	X 0	0	0	Comfort
02	X 0	0	0	Standby
03	X 0	0	0	Night-time temperature reduction
04	X 0	0	0	Frost/heat protection

Table 17: Operating mode switch-over via object (1 byte) with priority of 2-bit object

Application description

KNX thermostat

KNX room controller

3.5.2.2 Notes on operating modes



Presence function / Comfort extension

The device can switch to comfort operation by a mode presence detection in the event of a movement. The "presence detection" and "Via presence detector" parameters in the "Room thermostat → General" parameter branch define here whether the presence detection takes place movement-controlled by a presence detector.

Presence detection by presence button:

If the presence button is activated, object 86 "presence object" is visible. Thus, if standby or night operation is activated, it is possible to switch to the comfort extension by a presence object value = "1". The extension is deactivated automatically once the parameterised "comfort extension time" has elapsed. A comfort extension can be deactivated early if the object has received a value = "0". It is not possible to retrigger the extension time.

If the duration of the comfort extension is set to "inactive", no comfort extension can be activated from the standby or night operation. In this case, the operating mode is not changed even though the presence function is activated.

The presence object or presence function is always deleted during a change-over to another operating mode or after deactivation of a priority mode. A presence function activated before a reset incl. object is always deleted after a reset.

Presence detection by presence detector

If a presence detector is activated as the presence detection type, the object 86 "presence object" is visible. Presence detectors can also be integrated into the room temperature control via this object. If a movement is detected ("1 - telegram), the controller switches to comfort operation. Another operating mode can still be selected.

After the delay time in the presence detector has elapsed ("0" - telegram), the controller switches back to the mode that was active before the presence detection.

A presence function activated before a reset is always deleted after a reset. In this case, the presence detector must transmit a new "1" telegram to activate the presence function.

Window status / Automatic frost protection control:

The devices have various options for switching to the frost/heat protection. Besides the change-over by the corresponding operating mode change-over object or by the holiday mode on the device, the frost/heat protection can be activated by a window contact, or alternatively, by an automatic temperature control of the frost protection. Among these options, the window contact or automatic control has the higher priority. The "frost/heat protection" parameter in the "Room thermostat - General" parameter branch defines how the higher change-over takes place according to priority:

Frost/Heat protection change-over "Via window contact":

Object 22 "Window contact state" is activated. A telegram with the value "1" (opened window) activates the frost/heat protection on this object. If this is the case, this operating mode cannot be deactivated by a local operation nor via the change-over object (with the exception of the KONNEX priority object).

The window status is first reset and the frost/heat protection deactivated with the value = "0" (closed window). After that, the tracked operating mode set before opening the window or during the opened window is activated via the bus.

A delay of the window status can be parameterised optionally. This delay can be useful if the room only needs to be ventilated briefly by opening the window and should not cause any changeover of the operating mode. The delay time is set by the "frost/heat protection change-over delay" and can be between 1 and 255 minutes. The window status and the the frost/heat protection is first activated after the parameterised time has elapsed. The "0" setting causes the immediate activation of the frost/heat protection on the opened window. The window status is effective in heating and in cooling operation. The "window contact state" object is deleted ("0") after a reset.

Application description

KNX thermostat

KNX room controller



Frost protection change-over by "Automatic Frost/Heat protection":

With this setting, it is possible to change over automatically to the frost protection temporarily depending on the determined room temperature. If no window contacts are available, this setting can prevent the room from cooling down or heating up unnecessarily if windows or outside doors are opened.

With this function a rapid temperature drop can be detected by measuring the actual temperature, as caused by an opened window, for example.

If the detected reduction reaches the parameterised value, the room thermostat changes over automatically to frost protection, taking into account the set delay time. The "Automatic with" parameter defines the maximum temperature drop for the frost protection change-over in °C/min.

If a change-over took place via the objects (4 x 1 bit or 1 byte) during the frost protection and a new operating mode is received, this tracked mode is set after the automatic frost protection.

The automatic frost protection control has the same priority during an operating mode change-over in comparison with the alternative setting of the frost/heat protection detection by the window contact!

Notice:

In the case of frequent draughts in a room, this can cause unwanted activation/deactivation of the frost protection if the automatic frost protection control is activated and the parameterised reduction is too low. The change-over to frost/heat protection by window contacts of the automatic control are generally preferable!

Status after reset

In the "Room thermostat - General" parameter branch, it is possible to predefine which operating mode should be activated after bus voltage recovery or after a programming process by the ETS via the parameter "State after reset". The following settings are possible here:

- "Comfort": After the initialization phase, the comfort operation is activated.
- "Standby": After the initialization phase, the standby operation is activated.
- "Night": After the initialization phase, the night operation is activated.
- "Frost/heat protection": After the initialization phase, the frost/heat protection is activated.
- "State after reset": The mode activated prior to a reset is set again after the initialisation phase of the device.

A presence function activated before the reset incl. object is deleted after a reset.

3.5.2.3 Transmission of set temperature

The setpoints for the heating and cooling predefined or subsequently adjusted by the active operating modes can be transmitted via the bus. The 8-byte objects 79 "Status setpoints heating" and 84 "Status setpoints cooling" are available for this purpose. These include the setpoints for all four operating modes Comfort, Standby, Night and Frost/heat protection. Each for the heating and cooling. Additionally, the 2-byte object 75, 76, 77 and 78 for heating and the objects 80, 81, 82 and 83 for cooling are provided as setpoint status of the four operating modes.

The setpoints are transmitted immediately after the programming, after a reset and during each change of the setpoint.

3.5.2.4 Operating modes and operating modes changeover

The device knows up to two operating modes These operating modes define whether the controller should control heating systems (individual operating mode "heating") or cooling systems (individual operating mode "cooling") via its command value. It is also possible to activate a mixed operation whereby the controller can change-over between "heating" and "cooling" automatically or, alternatively, object-controlled.

Application description

KNX thermostat

KNX room controller



Furthermore, the standard operation can be executed in two stages for controlling an additional heating or cooling unit. With two-stage control, separate command values are calculated and transmitted to the bus for the basic and additional stage depending on the set/actual temperature deviation.

The "operating mode" parameter in the "Room thermostat - General" parameter branch defines here the operating mode to be executed and activates the additional stage(s) if necessary.

In the individual operating modes "Heating" or "Cooling" without any additional stage, the controller always works with just one command value, alternatively with an activated additional stage, the controller works with two command values in the parameterised operating mode. Depending on the determined room temperature and predefined set temperatures of the operating modes, the room thermostat decides autonomously whether heating or cooling energy is required and calculates the command value for the heating or cooling system.

During "Heating" or "Cooling", the controller is always in the predefined operating mode after a reset (bus voltage recovery or reprogramming by the ETS).

In the "Heating and Cooling" mixed operation mode, the controller is able to control heating and cooling systems. The change-over behaviour of the operating mode can be predefined here:

- The "Heating/cooling-changeover" parameter in the "Room thermostat - General" parameter branch is set to "Automatic":

In this case, a heating or cooling operation is activated automatically depending on the determined room temperature and predefined temperature setpoint. If the room temperature is within the set dead zone, the room is neither heated nor cooled (both command values = "0"). When the display is pressed, the last active temperature setpoint for heating and cooling is displayed here. If the room temperature is greater than the temperature setpoint for cooling, the room is cooled. If the room temperature is less than the temperature setpoint for cooling, the room is heated. (see Figure 74 auf Seite 95).

If the change-over of the operating mode is automatic, the information about the object 20 "Heating/cooling-changeover" regarding whether the controller is working in heating operation ("1" - telegram) or in cooling operation ("0" - telegram) can be output actively to the bus.

Note on automatic change-over of the operating mode:

-  If the same setpoints are used for heating and cooling in the respective operating mode, the resulting dead zone is very small. This may result in a constant change-over between heating and cooling.

For this reason, the setpoints must be selected with care and should be based on the values entered previously.

- The "Heating/cooling-changeover" parameter in the "Room thermostat - General" parameter branch is set to "Via object":

In this case, the operating mode is controlled via object 20 "Heating/Cooling - Changeover". This type of change-over could be required, for example, if it is necessary to heat and cool using a one-pipe system (combined heating and cooling system). For this purpose, the temperature of the medium in the one-pipe system must first be changed by the system control.

Afterwards, the operating mode is set via the object (cooling in the summer often takes place in a one-pipe system with cold water, and in the winter heating often takes place with hot water).

The "Heating/cooling - changeover" has the following priority: **„1“: Heating; „0“: Cooling.**

After a reset, the object value is "0" and the "heating/cooling operation after reset" is activated.

With the "heating/cooling operation after reset" parameter it is possible to define which operating mode is activated after a reset. With the "Heating" or "Cooling" settings, the controller activates the parameterised operating mode immediately after the initialisation phase. With the "Operating mode before reset" parameterisation, the operating mode set prior to the reset is activated. During a change-over via the object operating mode, the system first changes to the operating mode predefined after the reset. The system will first possibly change over to the other operating mode when the device receives an object update.

Application description

KNX thermostat

KNX room controller

3.5.3 Basic heating



In the "Basic heating" menu, the parameters must be set for the heating control, type of heating and its additional parameters.

Figure 18: Room thermostat - Basic heating

Parameter	Description	Value
Type of heating control	This parameter selects the type of the heating control	Continuous PID control Switching PI control (PWM) * Switching 2-point control
Hysteresis 1	Definition of the temperature hysteresis for switching the heating on and off.	+0.3 ... +0.5 * ... +3.0 °C
Hysteresis time 1	Defines the parameter for the hysteresis time.	Inactive 1 ... 5 * ... 10 min
Type of heating	This parameter selects the heating type.	Warm water heating * Warm water underfloor heating Electric heating Electric underfloor heating Convector fan Split-Unit Via control parameters
Underfloor heating temperature limit 2	(Checkmark is enabled by default). This parameter is used to limit the floor temperature.	
Fan is also used for heating	(Checkmark is disabled by default). This parameter is only visible if the "Fan available" checkmark in the "General" parameter is enabled. Thus, any connected fan can be used for heating support.	
Cycle time ^{3 4}	The cycle time setting makes it possible to adapt the control to the drives that are used. The cycle time defines the switching sequence of the pulse modulated signal and allows adjustment to the adjustment cycle times of the actuators used (Travel time that the drive needs for adjusting the valve from the fully closed position to the fully opened position).	5 min ... 10 min * ... 1h 30 min
Proportional range ³	Defines the proportional range of the control loop (proportional coefficient).	0.5°C ... 3.0°C * ... 6.0 °C
Integration time ³	Defines the integration time (I proportion).	Inactive 15 min ... 30 min * ... 4 h
Differential time ³	Defines the differential time (D part).	Inactive 15 min ... 30 min * ... 4 h
Polarity ⁵	(Checkmark is disabled by default (Figure 24, 1)). This parameter is used to adapt the control to the corresponding valve drives.	

Table 18: Room thermostat - Basic heating

Application description

KNX thermostat

KNX room controller



i For information on the control types go to chapter 9.1 auf Seite 95.

¹ These parameters are only visible when the value "Switching 2-point control" is selected under "Type of heating".

² This parameter is only visible when the values "Underfloor heating" or "Electrical underfloor heating" are selected under "Type of heating control". The floor temperature measurement also has to be activated in "Temperature measurement".

³ These parameters are only visible when the value "Via control parameters" is selected under "Type of heating control".

⁴ These parameters are only visible when the value "Via control parameters" is selected under "Type of heating control" and the value "Switching PI control (PWM)" is selected under "Type of heating".

⁵ This parameter is only visible when the value "Switching PI control (PWM)" or "Switching 2-point control" is selected under "Type of heating".

No.	Name	Object function	Length	Data type
32	Room thermostat	Switching	1bit	1.001 DPT_ON/OFF
33	Room thermostat	Valve position in %	1 byte	5.001 DPT_Percentage (0-100 %)

i If the "Type of heating control via control parameters" occurs, knowledge of heating/ventilation/control technology should exist.

3.5.4 Additional heating

The parameters for the additional heating are only visible if the function basic heating and additional heating or basic heating and additional heating/cooling is selected.

General → Operating mode → Basic heating and additional heating

or

General → Operating mode → Basic heating and additional heating/cooling

Depending on the selection under "Type of heating control" and "Type of heating", additional parameters open for setting the "Additional heating" function.

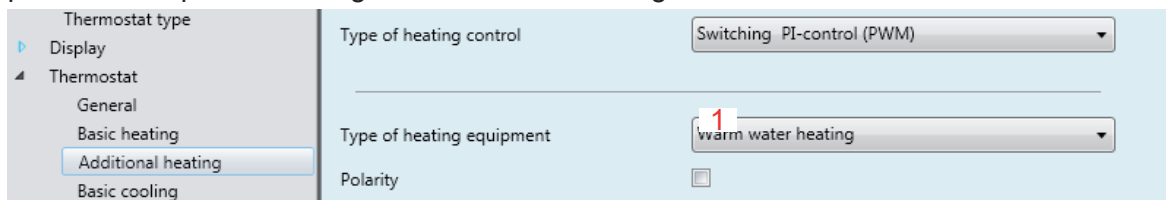

Figure 19: Room thermostat - Additional heating

Like the "Basic heating" function, the "additional heating" function is parameterised in chapter 3.5.3 auf Seite 36.

No.	Name	Object function	Length	Data type
36	Room thermostat	Switching	1bit	1.001 DPT_ON/OFF
37	Room thermostat	Valve position in %	1 byte	5.001 DPT_Percentage (0-100 %)

* Default value

Application description

KNX thermostat

KNX room controller

3.5.5 Basic cooling



In the "Basic cooling" menu, the parameters must be set for the cooling control, type of cooling and its additional parameters.

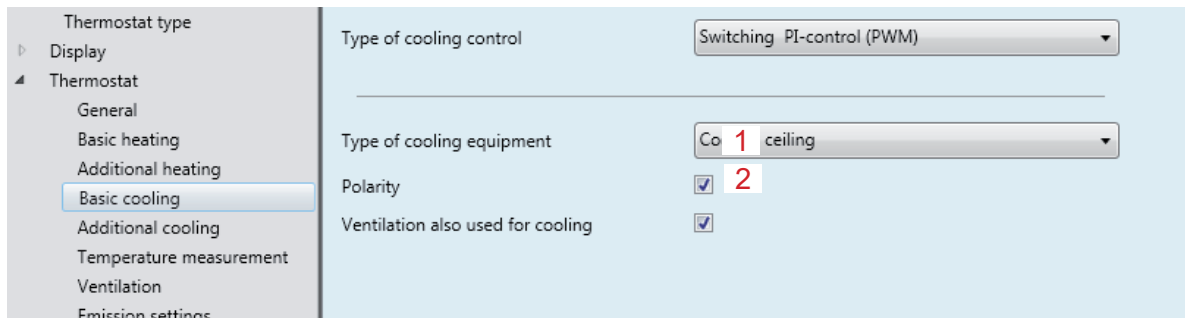

Figure 20: Room thermostat - Basic cooling

Parameter	Description	Value
Type of cooling control	The type of control is selected with this parameter.	Continuous PI control * Switching PI control (PWM) * Switching 2-point control
Hysteresis 1	Definition of the temperature hysteresis for switching the heating on and off.	+0.3 ... +0.5 * ... +3.0 °C
Hysteresis time ¹	Defines the parameter for the hysteresis time.	Inactive 1 ... 5 * ... 10 min
Type of cooling	This parameter selects the cooling type.	Cooling ceiling * Convector fan Split unit Via control parameters
Fan is also used for cooling	(Checkmark is disabled by default (Figure 20, 2). This parameter is only visible if the "Fan available" checkmark in the "General" parameter is enabled. Thus, any connected fan can be used for cooling support.	
Cycle time ^{2 3}	The cycle time setting makes it possible to adapt the control to the drives that are used. The cycle time defines the switching sequence of the pulse modulated signal and allows adjustment to the adjustment cycle times of the actuators used (Travel time that the drive needs for adjusting the valve from the fully closed position to the fully opened position).	5 min ... 10 min * ... 1h 30 min
Proportional range 2	Defines the proportional range of the control loop (proportional coefficient).	0.5°C ... 3.0°C * ... 6.0 °C
Integration time ²	Defines the integration time (I proportion).	Inactive 15 min ... 30 min * ... 4 h
Differential time 2	Defines the differential time (D proportion).	Inactive 15 min ... 30 min * ... 4 h
Polarity ⁴	(Checkmark is disabled by default (Figure 20, 1)). This parameter is used to adapt the control to the corresponding valve drives.	

Table 19: Room thermostat - Basic cooling

¹ These parameters are only visible when the value "Switching 2-point control" is selected under "Type of cooling".

Application description

KNX thermostat

KNX room controller



² These parameters are only visible when the value "Via control parameters" is selected under "Type of cooling control".

³ These parameters are only visible when the value "Via control parameters" is selected under "Type of cooling control" and the value "Switching PI control (PWM)" is selected under "Type of heating".

⁴ This parameter is only visible when the value "Switching PI control (PWM)" or "Switching 2-point control" is selected under "Type of cooling".

No.	Name	Object function	Length	Data type
34	Room thermostat	Switching	1bit	1.001 DPT_ON/OFF
35	Room thermostat	Valve position in %	1 byte	5.001 DPT_Percentage (0-100 %)

i If the "Type of cooling control via control parameters" occurs, knowledge of heating/ventilation/control technology should exist.

i For information on the control types go to chapter 9.1 auf Seite 95.

The following communication objects appear when the "Heating and cooling command value to a common object" parameter is selected.

No.	Name	Object function	Length	Data type
32	Room thermostat	Switching	1bit	1.001 DPT_ON/OFF
33	Room thermostat	Valve position in %	1 byte	5.001 DPT_Percentage (0-100 %)

3.5.6 Additional cooling

The parameters for the additional cooling are only visible if the function basic cooling and additional cooling or basic heating and additional heating/cooling is selected.

General → Operating mode → Basic cooling and additional cooling

or

General → Operating mode → Basic heating and additional heating/cooling

Depending on the selection under "Type of cooling control" and "Type of cooling", additional parameters open for setting the "Additional cooling" function.

Thermostat type: Thermostat

Type of cooling control: Switching PI-control (PWM)

Type of cooling equipment: Cooling ceiling

Polarity:

General

Basic heating

Additional heating

Basic cooling

Additional cooling

Figure 21: Room thermostat - Additional cooling

Like the "Basic cooling" function, the "Additional cooling" function is parameterised in chapter 3.5.5 auf Seite 38.

No.	Name	Object function	Length	Data type
38	Room thermostat	Switching	1bit	1.001 DPT_ON/OFF
39	Room thermostat	Valve position in %	1 byte	5.001 DPT_Percentage (0-100 %)

* Default value

Application description

KNX thermostat

KNX room controller

3.5.7 Temperature measurement



The room thermostat measures the actual temperature and compares this with the predefined set temperature. The command value is calculated from the difference between the actual and set temperature by means of the set control algorithm.

When selecting the installation site of the device or external sensor, the following points should be taken into consideration:

- Integrating the device into multiple combinations should be avoided especially when a flush-mounted dimmer is also installed.
- The sensors should not be installed near to large electrical consumers (heat radiation).
- The device/sensor should not be installed near to heaters or cooling systems.
- The temperature sensor must be kept out of direct sunlight.
- Installing sensors on the inside of external walls may negatively influence the temperature measurement.
- Temperature sensors should be installed at least 30 cm away from doors and windows and at least 1.5 m above the floor.



Room thermostat → Temperature measurement

Thermostat type	Room temperature detection	Internal temperature sensor + room temperature object
+ Display	Weighting of the measured values	50% - 50%
- Thermostat	Timeout of room temperature	30 min
General	Floor temperature detection	External temperature sensor
Basic heating	Maximum floor temperature	+28,0°C
Additional heating	Outdoor temperature detection	Not active
Basic cooling	Hysteresis for room temperature object emission	0,5K
Additional cooling	Periodical emission delay of room temperature value	0 min
Temperature measurement	Emission room temperature alarm through objects	<input type="checkbox"/>
Ventilation		
Emission settings		
Setpoints		
Setpoint shift		
Scene		

1

Figure 22: Temperature measurement settings



After commissioning, voltage loss or download of the application software it can take up to 30 minutes until the device has adapted to the ambient temperature and the internal temperature sensor delivers correct measured values.

Parameter	Description	Value
Room temperature detection	<p>Defines which sensor is used for room temperature control of the control circuit.</p> <p>Internal sensor: Built-in sensor in the device.</p> <p>External sensor: An additional external sensor attached to the device, e.g. under difficult measuring conditions (swimming pool or similar.).</p> <p>Internal and external sensor: Both sensors are used, e.g. in large rooms.</p> <p>Room temperature object: The measured room temperature is provided via the bus. E.g. via a push-button.</p>	<p>Internal temperature sensor and room temperature object *</p> <p>Internal temperature sensor Only via external temperature sensor Via object External sensor + object</p>
Weighting of the measured values 1	<p>Defines the weighting of the temperature measurement as soon as two sources are used for measuring the temperature. Thus, a resulting total measured value is calculated, which is used for further evaluation of the room temperature.</p>	<p>10 % - 90 % 20 % - 80 % 30 % - 70 % 40 % - 60 % 50 % - 50 % * 60 % - 40 % 70 % - 30 % 80 % - 20 % 90 % - 10 %</p>
Timeout room temperature object ²	<p>If no temperature value is received during the temperature measurement "via object", then an error message appears in the display after a set time.</p>	<p>0 ... 30 *... 255 min</p>
Floor temperature detection	<p>Defines type of room temperature detection</p> <p>Ext. temperature sensor: Temperature sensor is connected to the device.</p> <p>Via object: Temperature value is provided via the bus.</p>	<p>Inactive External temperature sensor * Via object</p>
Maximum floor temperature	<p>Defines the maximum floor temperature.</p>	<p>24°C ... 28 °C * ... 46 °C</p>
Timeout floor temperature object ³	<p>If no temperature value is received during the temperature measurement "via object", then an error message appears in the display after a set time.</p>	<p>0 ... 30 min *... 255 min</p>
Detection of outside temperature	<p>Defines type of outdoor temperature detection</p> <p>Ext. temperature sensor: connected to the device</p> <p>Via object: ext. temperature sensor is connected to an additional device.</p>	<p>Inactive * External temperature sensor Object temperature sensor</p>
Timeout outside temperature object ⁴	<p>If no temperature value is received during the temperature measurement "via object", then an error message appears in the display after a set time.</p>	<p>0 ... 30 min *... 255 min</p>

Application description

KNX thermostat

KNX room controller



Hysteresis - temperature change	Defines the transmission behaviour of the temperature i.e. at what temperature difference the room temperature value should be transmitted to the bus.	0.1°C ... 0.5°C * ... 5.0°C
Time for periodical transmission of room temperature	Defines the transmission behaviour of the temperature i.e. at what time interval the room temperature value should be transmitted to the bus.	0 *... 255 min
Transmitting room temperature alarm via object	If this parameter is activated (set checkmark (Figure 22 ,1), two additional parameters open for setting the upper/lower temperature threshold values. In the course of this, an alarm message is transmitted to the bus via the objects 44 and 45 if the alarm limits are exceeded or fallen below.	
Minimum room temperature ⁵	If the set value is fallen below, an alarm message is transmitted to the bus.	0°C - 7 °C * ... 40°C
Maximum room temperature ⁵	If the set value is exceeded, an alarm message is transmitted to the bus.	0°C - 35°C * ... 40°C

Table 20: Temperature measurement settings

¹ This parameter is only visible if under "Room temperature detection" the value "External sensor + Objekt or internal temperature sensor and room temperature object" is selected.

² These parameters are only visible if under "Room temperature detection" the value "External temperature sensor + Objekt or Via object and via internal temperature sensor and room temperature object" is selected.

³ This parameter is only visible if under "Floor temperature detection" the value "Via object" is selected.

⁴ This parameter is only visible if under "Detection of outside temperature" the value "Via object" is selected.

⁵ This parameter is only visible if under "Room temperature alarm" the checkmark for transmit via object is activated.

The device has an integrated temperature sensor. Alternatively (e.g. if the installation location of the device is unfavourable or under difficult operating conditions such as in humid areas) or additionally (e.g. in large rooms or halls), a second externally attached temperature sensor can be used to determine the actual value or a temperature value via an object (e.g. of a push-button).

 After commissioning, voltage loss or download of the application software it can take up to 30 minutes until the device has adapted to the ambient temperature and the internal temperature sensor delivers correct measured values.

* Default value

Application description

KNX thermostat

KNX room controller

3.5.8 Ventilation



The device in its function as a room thermostat controller and room controller can also control FanCoil actuators. Heating or cooling fans are normally connected to FanCoil actuators. This makes it possible to control the fan driven by heating and cooling systems depending on the control parameters as well as manually via the display.

The actuators mostly implement constant command values of the devices in corresponding switching levels and thus the ventilation level of the connected fans. The greater the command value, the more switching levels activated on the actuator.

FanCoil actuators are able to transmit the current fan speed back to the bus as a response value. The current fan speed is shown in the display.

Firstly, under "Room thermostat → General → Fan available" the checkmark must be set (Figure 23 ,1).

Room thermostat → Ventilation

Thermostat type	By a 2-point control no fan control is foreseen	
+ Display	Polarity	<input checked="" type="radio"/> 0 = automatic mode, 1 = manual mode <input type="radio"/> 1 = automatic mode, 0 = manual mode
- Thermostat	Ventilation object	<input type="radio"/> Object (1 bit) <input checked="" type="radio"/> Value object (1 byte)
General	Number of ventilation steps	3 steps
Basic heating	Start ventilation step 1 by	1 %
Additional heating	Start ventilation step 2 by	20 %
Basic cooling	Start ventilation step 3 by	40 %
Additional cooling	Hysteresis	3 %
Temperature measurement	Timing between ventilation step	2 1/10s
Ventilation	Ventilation step on manual switching	No change
Emission settings	Overrun time heating	0 1/10s
Setpoints	Overrun time cooling	0 1/10s
Setpoint shift	Start ventilation step	Step 3
Scene		
+ Internal temperature sensor		
+ External temperature sensor		
+ Information		

Figure 23: Fan Coil/ventilation function

Parameter	Description	Value
Polarity ¹	This parameter sets which 1-bit signals switch on the automatic/manual operation.	0 = Automatic mode, 1 = Manual mode * 1 = Automatic mode, 0 = Manual mode
Ventilation object	Defines what type of object controls the fan speeds or displays the status. A 1-bit object for each fan speed or a 1-byte object for all speeds together are available for selection.	Value object 1-byte * Switching object 1-bit
Number of fan speeds ²	This parameter sets the number of fans speeds (max. 6).	Inactive Stage 1 Stage 2 Stage 3 * Stage 4 Stage 5 Stage 6
Start of the fan speed X (X = 1 ... 6)	In these parameters, the individual value is set for each fan speed using the sidebar.	0 ... 100 %
Hysteresis	This parameter sets a difference value for all fan speeds (example: fan speed = 40%; hysteresis = 10%; fan speed has an upper threshold value at 44% and a lower threshold value at 36%). If the threshold value (e.g. 44%) is exceeded, the next higher fan speed is switched on.	0 ... 3 * ... 100 %
Time between fan speeds	Determines the minimum period to wait between changing over between two steps so that the fan can first reach its full speed.	0 ... 2 * ... 255 ¹ / _{10s}
Fan speed in manual operation	This defines here which fan speed is active when changing over to manual operation.	Off 1 2 3 4 5 6 No change *
Delay time, heating	This parameter sets the ventilation time in "Heating" operation, i.e. how long the fan is switched on in manual operation.	0 ... 2 * ... 255 ¹ / _{10s}
Delay time, cooling	This parameter sets the ventilation time in "Cooling" operation, i.e. how long the fan is switched on in manual operation.	0 ... 2 * ... 255 ¹ / _{10s}
Start fan speed	This parameter defines start fan speed at which the fan should start.	Off 1 * 2 3 4 5 6

Table 21: Function „Ventilation“

¹ Is only active if the fan is being used for heating and/or cooling.

² Depending on the number of fan speeds selected, a separate setting parameter opens for each individual fan speed (sidebar).

Application description



KNX thermostat

KNX room controller



i Owing to the inertia of a fan motor, the fan speeds cannot be switched over within arbitrary intervals. The fan speed cannot vary arbitrarily.

i The change-over times of the convector fans can be found in the technical data sheets.

In the display two different symbols for heating  or cooling  can be displayed. The fan speed is displayed in the centre of the fan symbol as a number. If a FanCoil actuator is switched off (no fan speed active), a zero is displayed in the centre of the fan symbol.

The device can be switched and reported back according to the status in two ways. Either the FanCoil actuator returns the feedback for up to six different 1-bit communication objects, or the actuator uses a 1-byte object as a combined feedback for all fan speeds.

At the same time, the "fan object" parameter defines the data type.

Setting "Switching object (1-bit)":

A separate 1-bit object is available for each fan speed. As soon as a fan speed is activated (object value "1"), the corresponding fan speed appears in the display as a number. In the course of this, the greatest fan speed is always displayed.















Objekt "Fan speed 1 ... 6"						active speed	Symbol (Heating/ cooling)
1	2	3	4	5	6		
Object no. 55	Object no. 56	Object no. 57	Object no. 58	Object no. 59	Object no. 60		
0	0	0	0	0	0	Off	 
1	0	0	0	0	0	1	 
1	1	0	0	0	0	2	 
1	1	1	0	0	0	3	 
1	1	1	1	0	0	4	 
1	1	1	1	1	0	5	 
1	1	1	1	1	1	6	 

Table 22: Fan speed "Switching object 1-bit"

Application description

KNX thermostat

KNX room controller

Setting "1 byte":

The fan speeds are controlled by a common 1-byte object. The received value decides which level appears in the device display.

















Objekt "Fan speed"	active speed	Symbol (Heating/cooling)
1 ... 6 Object no. 54		
00	Off	 
01	1	 
02	2	 
03	3	 
04	4	 
05	5	 
06	6	 

Table 23: Fan speed "Value object" (1 byte)

Application description

KNX thermostat

KNX room controller

3.5.9 Transmission settings



In this section, the transmission behaviour is set if value changes.

 Room thermostat → Transmission settings

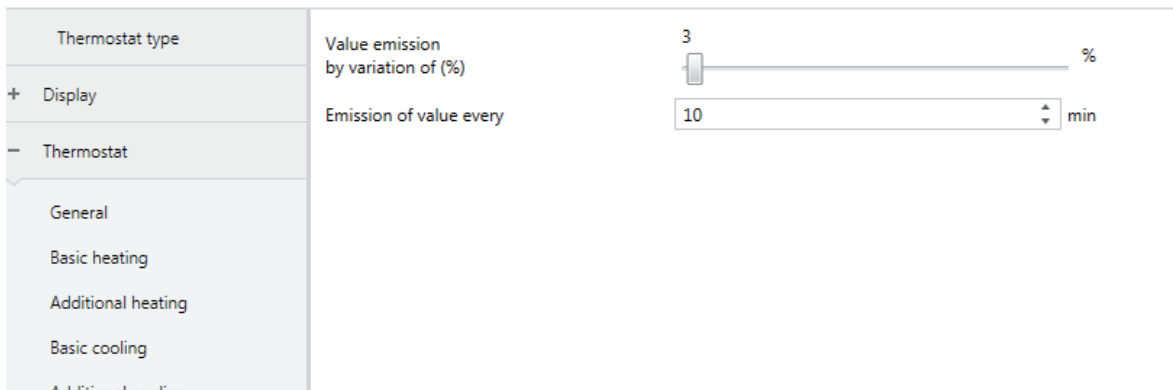

Figure 24: Transmission behaviour if value changes

Parameter	Description	Value
Send value when change is (%)	The hysteresis value from when an output value change should be transmitted is set with this parameter.	0 ... 3 * ... 100 %
Value send all	The cycle time for value transmission is set with this parameter.	0 ... 10 * ... 255 min

Table 24: Transmission settings





* Default value

Application description

KNX thermostat

KNX room controller

3.5.10 Setpoints

The temperature setpoints for heating and/or cooling are set in this section. Temperature setpoints can be assigned for each operating mode in heating and/or cooling operation. It is possible to set setpoints for the operating modes "Comfort , Standby , Night reduction , frost/heat protection  / 

 Room thermostats → Setpoints

 We recommend using the default settings in the ETS.

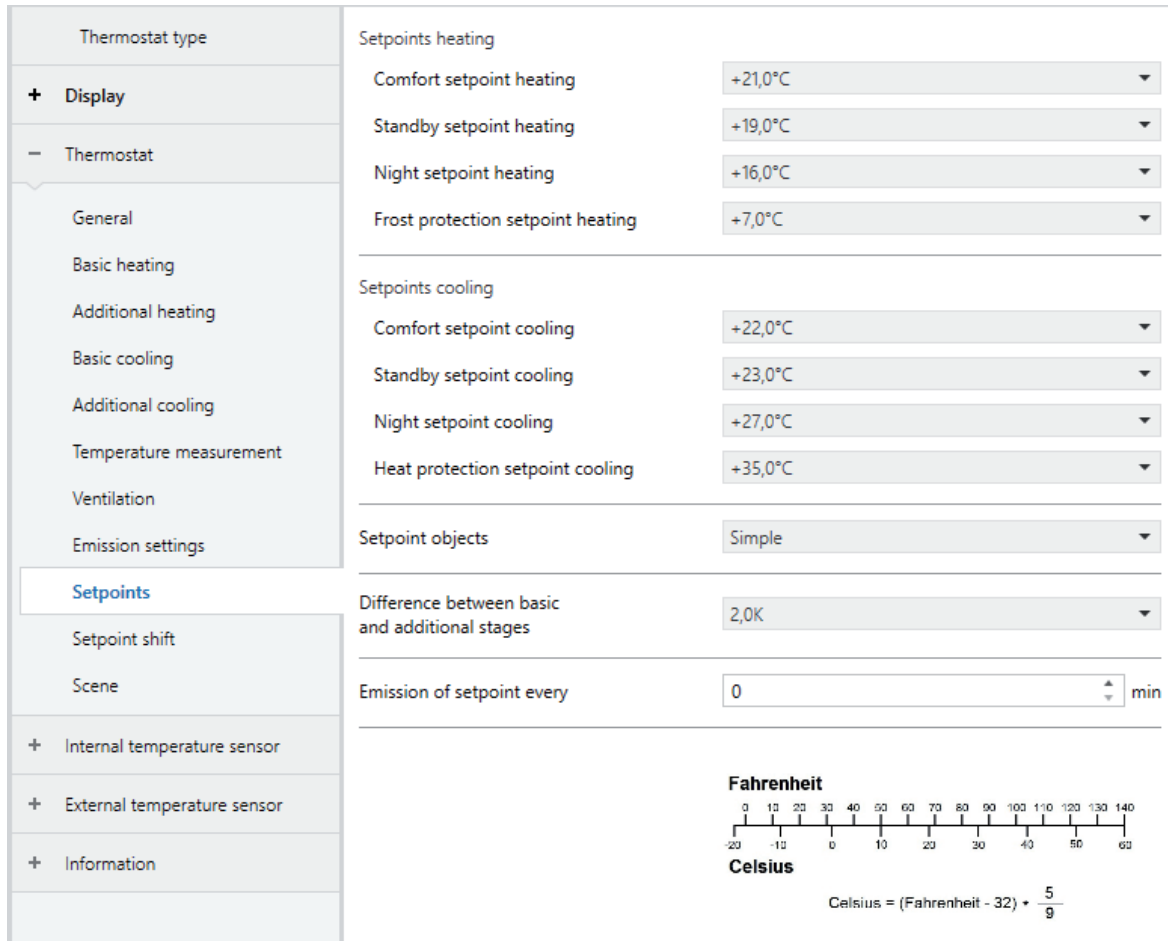

Thermostat type	Setpoints heating
+ Display	Comfort setpoint heating: +21,0°C
- Thermostat	Standby setpoint heating: +19,0°C
General	Night setpoint heating: +16,0°C
Basic heating	Frost protection setpoint heating: +7,0°C
Additional heating	
Basic cooling	Setpoints cooling
Additional cooling	Comfort setpoint cooling: +22,0°C
Temperature measurement	Standby setpoint cooling: +23,0°C
Ventilation	Night setpoint cooling: +27,0°C
Emission settings	Heat protection setpoint cooling: +35,0°C
Setpoints	Setpoint objects: Simple
Setpoint shift	Difference between basic and additional stages: 2,0K
Scene	Emission of setpoint every: 0 min
+ Internal temperature sensor	
+ External temperature sensor	
+ Information	

Fahrenheit
0 10 20 30 40 50 60 70 80 90 100 110 120 130 140
-20 -10 0 10 20 30 40 50 60

Celsius
$$\text{Celsius} = (\text{Fahrenheit} - 32) \cdot \frac{5}{9}$$

Figure 25: Setpoint Settings

The setpoints for the additional stages are derived by a parameterisable interval "difference between basic heating/cooling" of the basic stage.

Application description

KNX thermostat

KNX room controller

If required, the setpoints can be adjusted later during ongoing operation on the display of the device by a local operation or object controlled.



Operating mode	Heating setpoints
Comfort	+21 °C
Standby	+19 °C
Eco/Night	+16 °C
Frost protection	+7 °C

Table 25: Heating setpoints

Operating mode	Cooling setpoints
Comfort	+22 °C
Standby	+23 °C
Eco/Night	+27 °C
Heat protection	+35 °C

Table 26: Cooling setpoints

Parameter	Description	Value
Setpoint comfort (Heating) ¹	The setpoint for comfort operation is set with this parameter.	7 ... 21 * ... 40°C
Setpoint standby (Heating) ¹	The setpoint for standby operation is set with this parameter	7 ... 19 * ... 40°C
Setpoint night reduction (Heating) ¹	The setpoint for night reduction is set with this parameter	7 ... 16 * ... 40°C
Setpoint frost/heat protection (Heating) ¹	The setpoint for frost protection is set with this parameter	7 * ... 40°C
Setpoint comfort (Cooling) ²	The setpoint for comfort operation is set with this parameter	7 ... 22 * ... 40°C
Setpoint standby (Cooling) ²	The setpoint for standby operation is set with this parameter	7 ... 23 * ... 40°C
Setpoint night reduction (Cooling) ²	The setpoint for night reduction is set with this parameter	7 ... 27 * ... 40°C
Setpoint frost/heat protection (Cooling) ²	The setpoint for heat protection is set with this parameter	7 ... 35 * ... 40°C
Objects for setpoint	Defines the objects for changing the setpoints (Heating/Cooling). Single: Here, "2-byte objects" are available for each operating mode. Combined: Here, one "8-byte object" is available for all operating modes. Both: Here, 8-byte - and 2-byte objects are available.	Single * Combined Both
Difference between basic heating and additional heating/cooling ³	Here, the temperature interval between the setpoints of the basic stage to the additional stages is set for heating/cooling.	1 ... 2 * ... 10°K
Setpoint send all	Time until transmission of the setpoint	0 * ... 255 min

Table 27: Setpoint Settings

¹ The setpoints of heating can only be changed if a function is selected with "Heating participation" under parameter "Room thermostat → General → Operating mode".

² The setpoints of cooling can only be changed if a function is selected with "Cooling participation" under parameter "Room thermostat → General → Operating mode".

³ This parameter is only visible if a function is selected with "Basic/additional heating" under parameter "Room thermostat → General → Operating mode".

* Default value

Application description

KNX thermostat

KNX room controller

3.5.11 Setpoint shift



Under "KNX room thermostat → Setpoint shift", the values for the temperature adjustment are to be set on the display for the "Basic display" page. Here, the stage must first be set, i.e. by how many °C the temperature should change per push-button action.

If the customer should or must **not** permanently change the programmed setpoint on the display ("Permanently store setpoint change" is disabled), a reasonable lower and upper settings limit can be specified. The same limit applies in all operating modes.

If customers are permitted to permanently change the setpoint ("Permanently store setpoint change" is activated), they can always use the full settings range and all changes are stored immediately for the active operating mode.

i When operating the device with its display, only the **active** operating mode setpoint (of 8 possible options, see 3.5.10) is changed. When (manually or automatically) changing over the operating mode, either the programmed or last adjusted setpoint of this operating mode is activated.

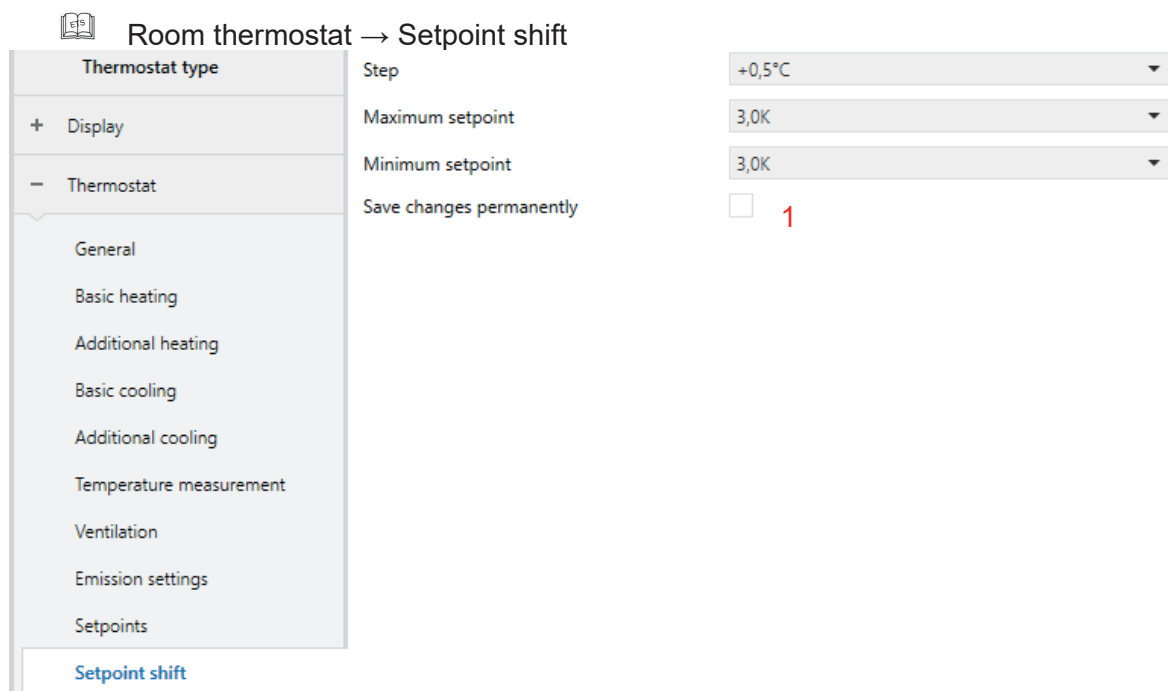

Figure 26: Room thermostat „Setpoint shift“

Parameter	Description	Value
Stage	Defines the increment for each push-button action. The temperature is increased/decreased by the set value with each push-button action.	+ 0.1 °C + 0.5 °C * + 1.0 °C
Maximum setpoint	Limits the possible temporary upward change (setpoint + x K)	+ 1.0 °C ... + 3.0 °C * ... + 10.0 °C
Minimum setpoint	Limits the possible temporary downward change (setpoint - x K)	+ 1.0 °C ... + 3.0 °C * ... + 10.0 °C
Apply change permanently	This function is deactivated as the default situation (Figure 26 ,1). If this function is activated, manual changes of the setpoint are then applied permanently on the display. The entire control range can be set as new setpoint. Any previously set setpoint limits will be ignored. If the function is deactivated, the adjustment of the setpoint is only applied for the duration of the operating mode active during this time. A setpoint change is only possible within the limits of the set limits.	

Table 28: Room thermostat „Setpoint shift“

¹ Only active when changes are **not** permanently stored.

* Default value

Application description

KNX thermostat

KNX room controller

3.5.12 Scene settings



In this section, the basic settings for the scene control must be made. It is possible to depict up to 64 scenes and to assign the operating mode function Auto, Comfort, Standby, Night lowering, Frost protection to the corresponding scenes.

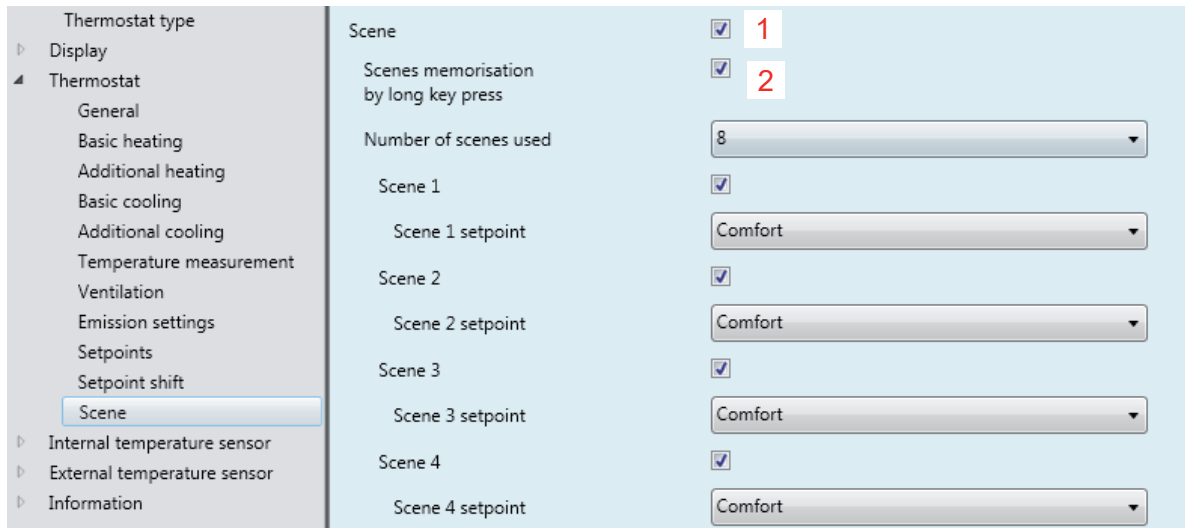

Figure 27: Scene settings

Parameter	Description	Value
Scene	This parameter is active by default (checkmark is set, Figure 27 ,1). The parameter settings can be displayed or hidden with this.	
Store scene by long key-press	This parameter is active by default (checkmark is set, Figure 27 ,2). A changed scene can be saved by a long press of the touch control surface.	
Number of scenes used	Defines how many scenes are needed. A maximum of 64 scenes can be created.	8 *...16...32...48...64
Scene x	If the checkmark is enabled on the corresponding scene x, these scenes can be parameterised.	
Control setpoint for scene x: 1	With this parameter, the corresponding operating mode is assigned to the selected scene.	Auto Comfort * Standby Night Reduction Frost Protection.

Table 29: Scene settings

¹ This parameter is only visible if the corresponding scene is activated.

“Scene” communication objects

No.	Name	Object function	Length	Datentyp
24	Room thermostat	Scene	1 byte	18.001 DPT_Scene control

* Default value

3.6 Temperature sensor settings

In this section, the settings for the internal temperature sensor as well as for an external temperature sensor to be connected additionally have to be made. The "temperature calibration" value, transmission behaviour at a temperature value change of ...°C" and the "transmission behaviour in time" has to be set for both temperature sensors.

3.6.1 Internal temperature sensor

In the "Internal temperature sensor" menu, the values for the temperature calibration are set. Here, a temperature reference measuring device should be for used the current room temperature control. This measured temperature value is compared with the measured temperature in the device and changed if necessary.

i After commissioning, voltage loss or download of the application software it can take up to 30 minutes until the device has adapted to the ambient temperature and the internal temperature sensor delivers correct measured values.



Internal temperature sensor → Internal temperature sensor

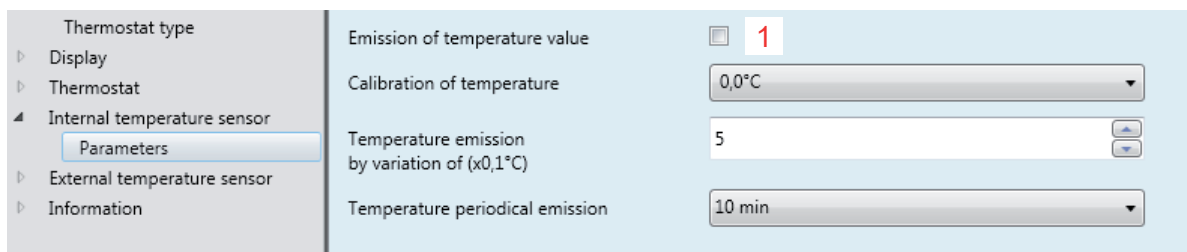

Figure 28: Internal temperature sensor settings

Parameter	Description	Value
Temperature value transmission	Checkmark is disabled by default (Figure 28,1). If this parameter is activated, the "communication object 89 - internal temperature sensor" is visible.	
Temperature calibration	Here, the difference between the temperature value on the device and the measured value e.g. of an external measuring device, is set.	-5°C - 0°C * ... +5°C
Temperature transmission by difference of (x 0.1°C)	Here, you set at what temperature difference the new measured temperature value should be transmitted to the bus. Example: Value=5 -->Temperature value changes by 0.5 K	0 ... 5 * ... 255
Temperature periodical transmission	The parameter determines the cycle time interval in which the measured temperature value is transmitted to the bus.	Inactive 10 s .. 10 min *

Table 30: Internal temperature sensor settings

No.	Name	Object function	Length	Data type
89	Temperature	Internal temperature sensor	2 byte	9.001 DPT_Temperature (°C)

* Default value

Application description

KNX thermostat

KNX room controller

3.6.2 External temperature sensor



In the "External temperature sensor" menu, the values for the temperature calibration are set. Here, a temperature reference measuring device can be used for the current room temperature control. This measured temperature value is compared with the measured temperature on the sensor and changed if necessary.



External temperature sensor → External temperature sensor

Figure 29: External temperature sensor settings

Parameter	Description	Value
Temperature value transmission	Checkmark is disabled by default (Figure 29,1). If this parameter is activated, the "communication object 90 - external temperature sensor" is visible.	
Temperature calibration	Here, the difference between the temperature value on the sensor and the measured value e.g. of an external measuring device, is set.	-5°C - 0°C * ... +5°C
Temperature transmission by difference of (x 0.1°C)	Here, you set at what temperature difference the new measured temperature value should be transmitted to the bus.	0 ... 5 * ... 255
Temperature periodical transmission	The parameter determines the cycle time interval in which the newly measured temperature value is transmitted to the bus.	Inactive 10 s .. 10 min *

Table 31: External temperature sensor settings

No.	Name	Object function	Length	Data type
90	Temperature	External temperature sensor	2 byte	9.001 DPT_Temperature (°C)

* Default value

In this section, the settings of the button functions are to be made. Up to 3 touch control surfaces with the functions Toggle switch, Switch, Dim, Roller shutter/Blind, Timer, Value 1byte/2byte, Priority, Scenes and Automatic functions can be assigned on a maximum of 9 pages.

i These functions are only integrated in the "room controller" device.

i The description of the touch function in the following sections is always carried out for "push-button 1". The settings must be made accordingly for button 2 - 9.

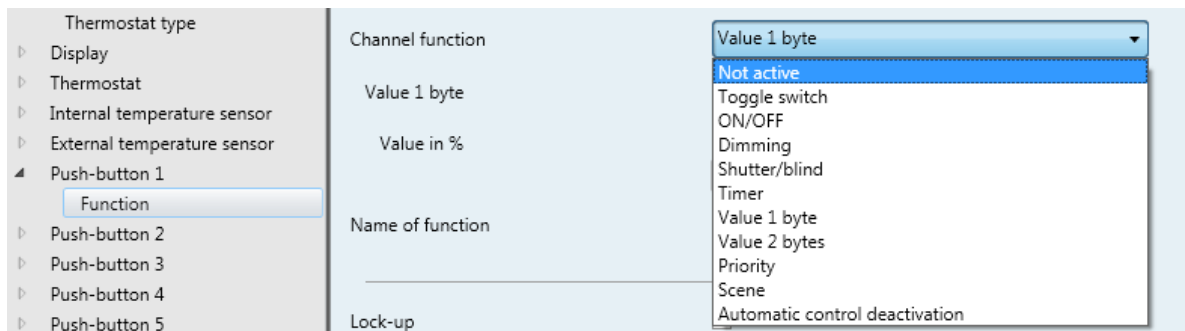

Figure 30: Settings of push-button functions

Parameter	Description	Value
Button x	With this option you assign the required function to the selected button.	Not active * Toggle switch ON/OFF Dimming Shutter/blind Timer Value 1 byte Value 2 bytes Priority Scene Automatic control deactivation
Lamp symbol 1	This parameter enables the selection of a suitable symbol for the push-button function. This symbol is displayed on one of the self-created display pages.	Switching * Ceiling lamp Floor lamp Wall lamp
Function name	In this parameter, a brief description (text field) can be attached to the selected symbol.	Free text, a maximum of 6 characters allowed
Page name, long (full screen) <i>Only as „Switching rocker function“</i>	In this parameter, a brief description (text field) can be attached to the selected symbol.	Free text, a maximum of 10 characters allowed

Table 32: Settings of push-button functions

¹ A maximum of 9 push-button functions can be parameterised

If one of the listed functions is selected, several selection parameters open depending on the function.

Application description

KNX thermostat

KNX room controller



These parameters can be set in each of the following button configurations.

Parameter	Description	Value
Lamp symbol ¹	This parameter enables the selection of a suitable symbol for the push-button function. This symbol is displayed on one of the self-created display pages.	Switching * Ceiling lamp Floor lamp Wall lamp
Function name	In this parameter, a brief description (text field) can be attached to the selected symbol.	Free text, a maximum of 6 characters allowed
Page name, long (full screen) <i>Only as „Switching rocker function“</i>	In this parameter, a brief description (text field) can be attached to the selected symbol.	Free text, a maximum of 10 characters allowed

Table 33: General button parameters

3.7.1 Display mode "Multiple functions" / "Rocker function"

The functions of the "button x" can be displayed in two different modes on the display and configured in the ETS.

The display mode is set in the menu item "Channel function → Operating concept".



Channel function → Operating concept

The screenshot shows a configuration window with a left sidebar and a main settings area. The sidebar contains a tree view with the following items: 'Thermostat type', '+ Display', '+ Thermostat', '+ Internal temperature sensor', and '+ External temperature sensor'. The main settings area is titled 'Channel function' and contains the following fields: 'Channel function' (dropdown menu with 'ON/OFF' selected), 'Lamp symbol' (dropdown menu with 'ON/OFF' selected), 'Using mode' (dropdown menu with 'ON/OFF rocker function' selected), 'Name of page, long (full screen)' (text input field), and 'Lock-up' (checkbox, currently unchecked).

Figure 31: Button "Operating concept"

* Default value

3.7.1.1 Multiple function button

A representation as depicted in Figure 32 is achieved by choosing the option no "rocker function" in the following parameter after selecting the channel function. This variant lists up to a maximum of three button functions beginning from the left on the display page. In the case of three consecutive push-button functions, the fourth push-button function is moved to the next display page. This means that a maximum of three display pages can additionally be configured for a total of 9 push-button functions.

If, however, a push-button function with the operating concept "rocker function" is selected, this "rocker function" will then be placed onto a separate display page on the next new page.

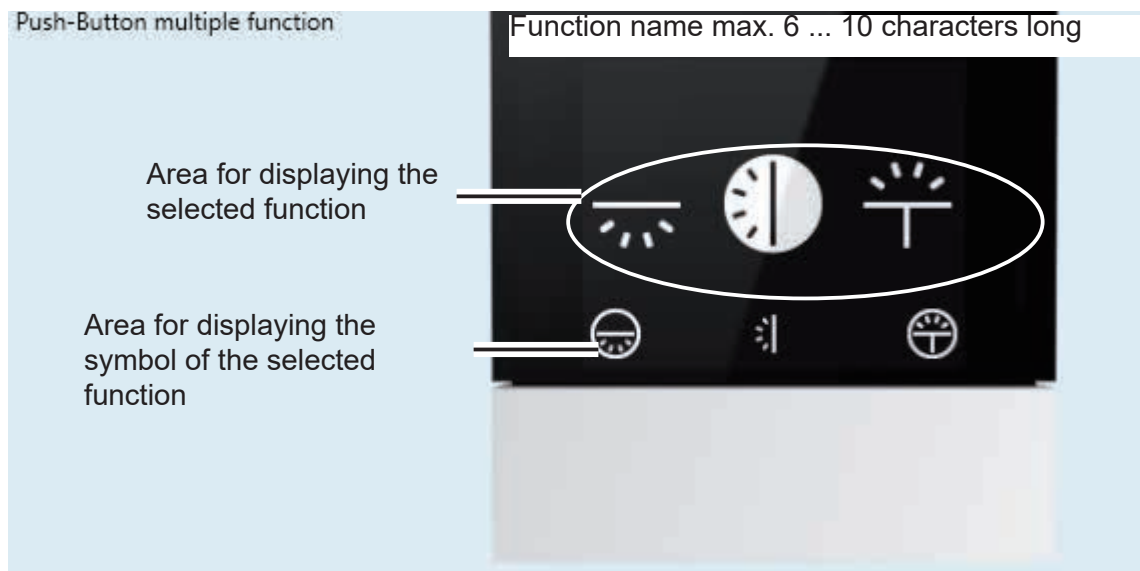

Figure 32: Multiple function button

3.7.1.2 Button Rocker function

A representation as seen in Figure 33 is achieved by selecting the "Rocker function" under Operating concept or Roller shutter function. The "Rocker function" operating concept is only available under the functions "switching, dimming and roller shutter/blind". A dedicated page is generated in the room controller for each button configured as rocker. Thus, up to nine display pages can be configured.

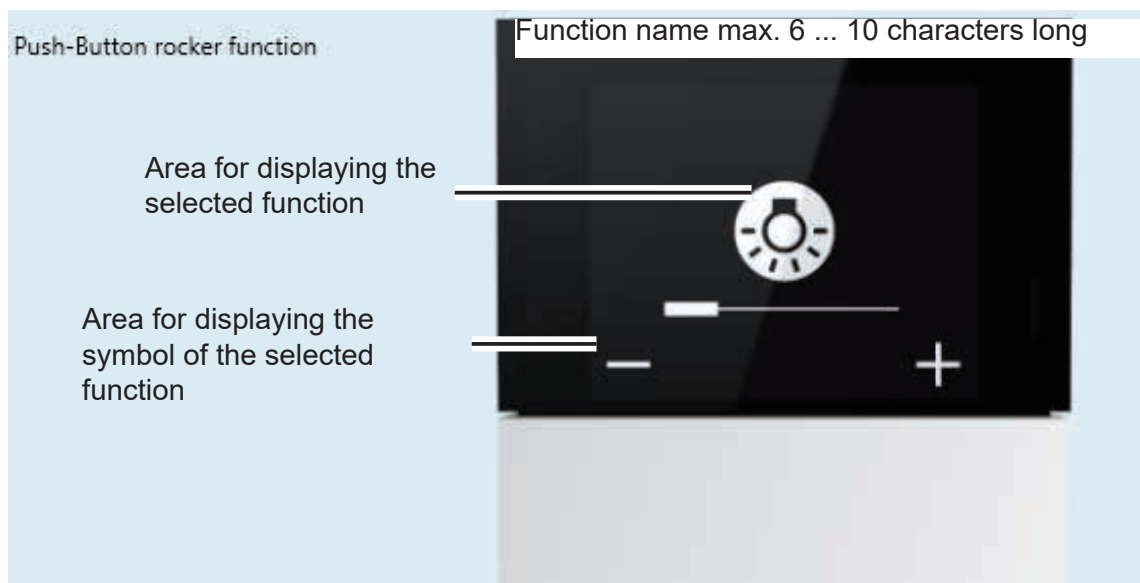

Figure 33: Button Rocker function

Application description

KNX thermostat

KNX room controller

3.7.2 Toggle switch function



In the "Toggle switch" function a new state change of the output is generated each time the touch control surface is pressed. The state changes with each new press.

When the corresponding touch control surface is pressed, an On or Off command is transmitted to the bus via the On/Off object depending on the object state. The inverted state is always sent. Even if the state was changed from another switchpoint:

(last command: On -> transmitted command Off; last command: Off -> transmitted command On).

Figure 34: Toggle switch function

i The two following parameters, "*Lamp symbol and function name*", are described only once here and are also relevant to the additional functions.

Parameter	Description	Value
Lamp symbol ¹	This parameter enables the selection of a suitable symbol for the push-button function. This symbol is displayed on one of the self-created display pages.	Switching * Ceiling lamp Floor lamp Wall lamp
Function name	In this parameter, a brief description (text field) can be attached to the selected symbol.	Free text, a maximum of 6 characters allowed

Table 34: Toggle switch function

¹: An overview of all symbols to be used, including a description, can be found in the Appendix of this document.

No.	Name	Object function	Length	Data type
95.107, 119.131, 143.155, 167.179, 191	Button 1 ... 9	Status indication Switching	1 bit	1.001 DPT_ON/OFF
100.112, 124.136, 148.160, 172.184, 196	Button 1 ... 9	Switching	1 bit	1.001 DPT_ON/OFF

* Default value

Application description

KNX thermostat

KNX room controller

3.7.3 Function switching



In the "Switching" function, depending on the parameterisation, an On or Off switching command is generated when the respective touch control surface is pressed (no change if pressed again) and is sent to the bus via the On/Off object. The transmitted command is independent of the previous output status. You can set which command is transmitted (ON or OFF) in the parameter "Operating concept".

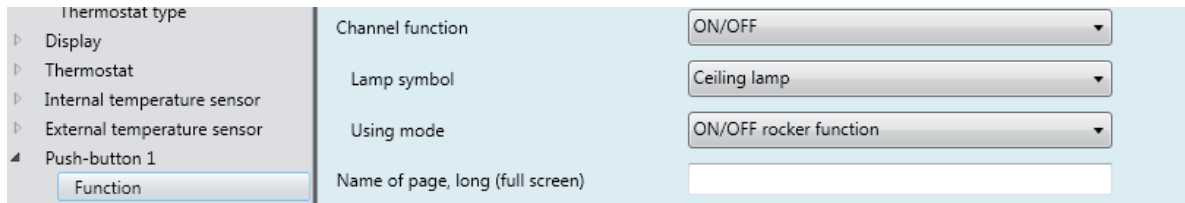

Figure 35: Function switching

Parameter	Description	Value
Operating concept	The function type during operation is set with this parameter.	ON OFF Switching rocker function *

Table 35: Function switching

No.	Name	Object function	Length	Data type
95.107, 119.131, 143.155, 167.179, 191	Button 1 ... 9	Status indication Switching	1 bit	1.001 DPT_ON/OFF
100.112, 124.136, 148.160, 172.184, 196	Button 1 ... 9	Switching	1 bit	1.001 DPT_ON/OFF

If in the function switching, "switching rocker " is selected under operating concept, a dedicated page is generated in the room controller.

Application description

KNX thermostat

KNX room controller

3.7.4 Function Dimming



The "dimming" function is used for dimming/switching light circuits. If a button is pressed for a short time, the device transmits an On or Off command to the bus via the On/Off object, and if a button is pressed for a long time, the push-button transmits a command via the dimming object for dimming up or down.

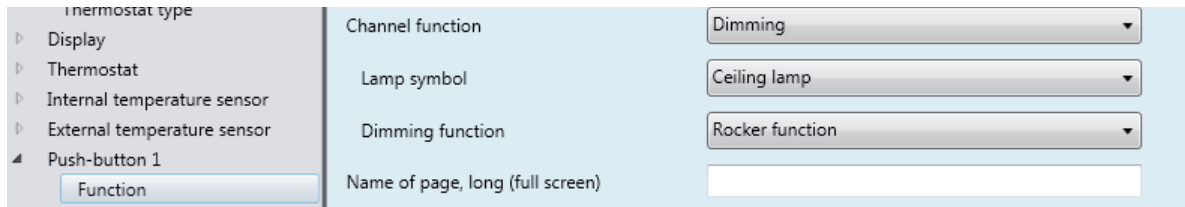

Figure 36: Function Dimming

Parameter	Description	Value
Operating concept	The function type during operation is set with this parameter.	Brighter (ON) Darker (OFF) Brighter (toggle switch) Darker (toggle switch) 1 dimming push-button (brighter/darker, toggle switch) Dimming value Rocker function *
Page name, long (full screen) ¹	In this parameter, a brief description (text field) can be attached to the selected symbol.	Free text, a maximum of 10 characters allowed
Dimming value	This parameter enables a fixed dimming value to be assigned to the lighting and the lamp by means of a fixed dimming value.	0 ... 100 %*

Table 36: Function Dimming

¹ This parameter is only visible if "rocker function" is selected for "dimming function".

i The blocking function can also be activated.

No.	Name	Object function	Length	Data type
95,107,119,131, 143,155,167 179,191	Button 1 ... 9	Status indication Switching	1 bit	1.001 DPT_ON/OFF
100,112,124 136,148,160, 172,184,196	Button 1 ... 9	Switching	1 bit	1.001 DPT_ON/OFF
97,109,121, 133,145,157, 169,181,193	Button 1 ... 9	Status indication Dimming	1 byte	5.001 DPT_Percentage (0-100 %)
103,115,127, 139,151,163 175,187,199	Button 1 ... 9	Dimming	1 bits	3.007 DPT_Dimmer step
104,116,128, 140,152,164, 176,188,200	Button 1 ... 9	Dimming value	1 byte	5.001 DPT_Percentage (0-100 %)

Function 1 Dimming the button (lighter/darker, toggle)

In the "1 Dimming the button (lighter/darker, toggle)" function, the switching state stored internally in the switching object is changed over when briefly pressing the button. When the stored state is ON (OFF), an ON (OFF) telegram is triggered. When pressing a button for longer, a "darker" telegram is sent after a "lighter" telegram and vice versa.

* Default value

Application description

KNX thermostat

KNX room controller

3.7.5 Shutter/blind function



The "Blind/shutter" function allows blinds, shutters, awnings or similar hangings to be opened and closed. Thereby, a distinction is made between long and short key-presses.

If a button is pressed for a long time, the device transmits an Up or Down command to the bus? via the Up/Down object, the shutter/blind moves to the respective end position or until a stop command is transmitted.

If a button is pressed for a short time, the device transmits a stop or a slat adjustment command via the stop object (step) or slat step/stop (step).

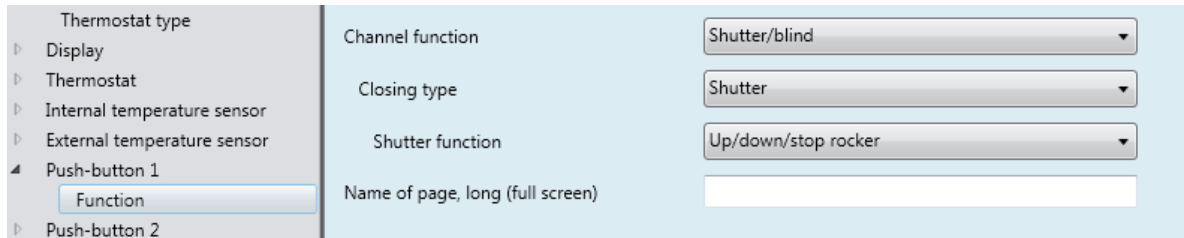

Figure 37: Function shutter

In the blind/roller shutter push-button function the choice must first be made between roller shutter or blind in the "operating mode" parameter. The roller shutter function or blind function parameters change depending on the selection.

3.7.5.1 Shutter function

Shutter		
Parameter	Description	Value
Shutter function	The operating mode is set during operation with this parameter.	Up/Down/Stop button Secured Up/Down/Stop button Up Down Secured Up(while pressed) Secured down (while pressed) Position (0-100%) Up/Down/Stop rocker * Secured Up/Down/Stop rocker
Page name, long (full screen) ¹	In this parameter, a brief description (text field) can be attached to the rocker function button.	Free text, a maximum of 10 characters allowed
Position (0-100 %) ²	This parameter enables a fixed percentage value and defined position to be assigned to the roller shutter by means of a slider.	0 ... 100 %*

Table 37: Function shutter

¹ This parameter is only visible if the value "Up/Down/Stop rocker or Secured Up/Down/Stop rocker" is selected in the parameter "Shutter function".

² This parameter is only visible if the value "Position (0-100%)" is selected in the parameter "Shutter function".

In the "Shutter" operating mode, the communication objects "top final position reached", bottom final position reached, status indication position in %, Up/Down, Stop (step)" can be selected from.

* Default value

Application description

KNX thermostat

KNX room controller



No.	Name	Object function	Length	Data type
95,107,119,131,143,155,167,179,191	Button 1 ... 9	Top final position reached	1 bit	1.002 DPT_Boolesch
96,108,120,132,144,156,168,180,192	Button 1 ... 9	Bottom final position reached	1 bit	1.002 DPT_Boolesch
97,109,121,133,145,157,169,181,193	Button 1 ... 9	Status indication position in %	1 byte	5.001 DPT_Percentage (0-100 %)
100,112,124,136,148,160,172,184,196	Button 1 ... 9	Up/down	1 bits	1.008 DPT_Up/Down
101,113,125,137,149,161,173,185,197	Button 1 ... 9	Stop (step)	1bit	1.017 DPT_Trigger

3.7.5.2 Function blind

Figure 38: Function blind

Blind		
Parameter	Description	Value
Function blind	The operating mode is set during operation with this parameter.	Up Down Secured up (while pressed) Secured down (while pressed) Slat angle (0-100%) Position/Slat angle (0-100%) Up/Down/Stop rocker * Secured up/down/Stop rocker
Page name, long (full screen) 3	In this parameter, a brief description (text field) can be attached to the rocker function.	Free text, a maximum of 10 characters allowed
Position (0-100 %) 4	This parameter enables a fixed percentage value and defined slat position to be assigned to the slat by means of a sidebar.	0 ... 100 % *
Slat angle (0-100%) 4 5	This parameter enables a fixed percentage value and defined position to be assigned to the slat by means of a sidebar.	0 ... 100 % *

Table 38: Function blind

³ This parameter is only visible if the value "Up/Down/Stop rocker or Secured Up/Down/Stop rocker" is selected in the parameter "Blind function".

⁴ These parameters are only visible if the value "Position/Slat angle (0-100%)" is selected in the parameter "Blind function".

⁵ This parameter is only visible if the value "Slat angle (0-100%)" is selected in the parameter "Blind function".

* Default value

Application description

KNX thermostat

KNX room controller



No.	Name	Object function	Length	Data type
95,107,119,131, 143,155,167 179,191	Button 1 ... 9	Top final position reached	1 bit	1.002 DPT_Boolesch
96,108,120, 132,144,156 168,180,192	Button 1 ... 9	Bottom final position reached	1 bit	1.002 DPT_Boolesch
97,109,121, 133,145,157, 169,181,193	Button 1 ... 9	Status indication position in %	1 byte	5.001 DPT_Percentage (0-100 %)
98,110,122, 134,146,158, 170,182,194	Button 1 ... 9	Slat position in %	1 byte	5.001 DPT_Percentage (0-100 %)
100,112,124, 136,148,160 172,184,196	Button 1 ... 9	Up/down	1 bits	1.008 DPT_Up/Down
101,113,125, 137,149,161, 173,185,197	Button 1 ... 9	Slat Step/Stop (step)	1bit	1.007 DPT_Step

Secured up/down/stop button, secured up (while pressed), secured down (while pressed) and secured up/down/stop rocker functions:

The "*Secured up/down/stop button, secured up (while pressed), secured down (while pressed) and secured up/down/stop rocker*" functions are security functions that can only be used in connection with the Hager switching/roller shutters and roller shutters/blinds actuator.

The function is only executed for as long as the button on the device is being pressed (safety gate controllers).

These functions do not have their own communication objects but are processed internally through the activated actuator function (e.g. secured up/down). The actual communication objects, such as Up/DOWN (1.008 DPT_Up/DOWN), must be linked according to the applicable KNX regulations.

Application description

KNX thermostat

KNX room controller

3.7.6 Timer function



In the "Timer" function, when a short key-press occurs, the parameterised switch output is switched for the time set in the switch actuator. When a long key-press occurs, the ongoing timer operation is interrupted and the switch output is switched off.

When a short key-press occurs, a 1-bit switch command is transmitted to the bus and the respective output is switched on. When a long key-press occurs, an OFF command is transmitted by the same 1-bit object.

i This timer function is in the Hager-/Berker system and has been adapted to the Hager TXA/TYA switch actuator.

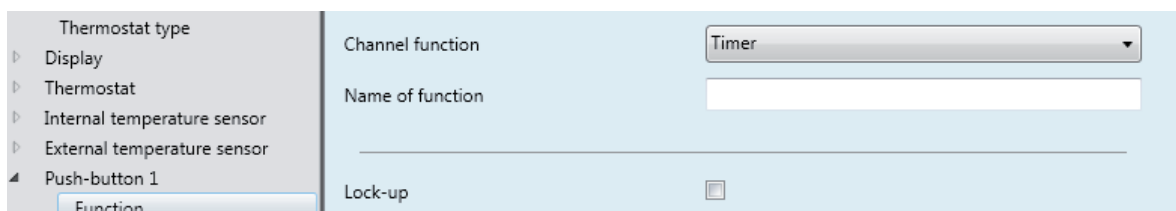

Figure 39: Timer function

i The "timer" function can only be used as a "Multiple function button" i.e. a rocker function is not possible here.

No.	Name	Object function	Length	Data type
95,107,119,131, 143,155,167 179,191	Button 1 ... 9	Status indication Switching	1 bit	1.001 DPT_ON/OFF
100,112,124 136,148,160, 172,184,196	Button 1 ... 9	Timer	1 bit	1.010 DPT_Start/Stop

Application description

KNX thermostat

KNX room controller

3.7.7 "Value 1 byte" function

In the following parameter window, the "Value 1 byte" function is parameterised and set as multiple function button in the using mode.

The application provides a 1-byte communication object for the button. Pressing a button transmits the set value to the bus.



Figure 40: Function value transmitter 1 byte/2 byte

Parameter	Description	Value
Value 1 bytes	The value type is set during operation with this parameter.	Percent (0-100%) Value (0-255) *
Value(0-255)	A fixed value can be assigned to the function with this parameter.	0 * ... 255
Value in %	This parameter enables a fixed percentage value to be assigned to the function by means of a slider.	0 * ... 100 %

Table 39: Value transmitter 1-byte function

i The "value 1 byte" function can only be used as a "Multiple function button" i.e. a rocker function is not possible here.

No.	Name	Object function	Length	Data type
104,116,128, 140,152,164, 176,188,190	Button 1 ... 9	Value(0-255)	1 byte	5.010 DPT_Counting pulses (0-255)
104,116,128, 140,152,164, 176,188,190	Button 1 ... 9	Value(0-100)	1 byte	5.010 DPT_Counting pulses (0..100%)

The "Value 1 byte" parameter defines which value range the device should use.

Relative values ranging from 0...100 % can be transmitted to the bus by means of a slide control for the value in % function.

* Default value

Application description

KNX thermostat

KNX room controller

3.7.8 Value 2 bytes function



In the following parameter window, the “Value 2 bytes” function is parameterised and set as multiple function button in the using mode.

The application provides a 2 bytes communication object for the button. Pressing a button transmits the set value to the bus.

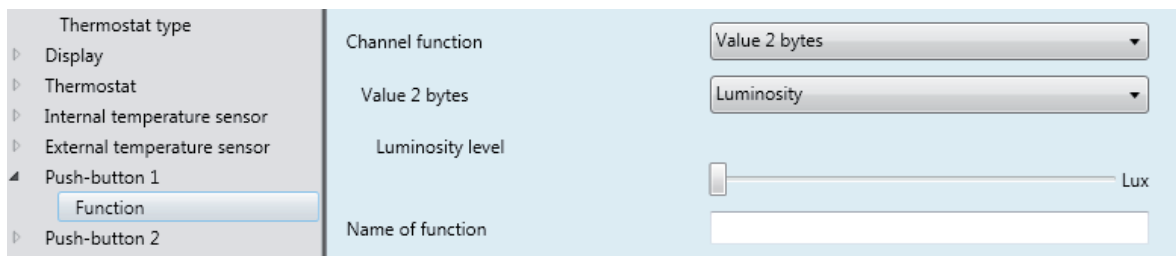

Figure 41: Value 2 bytes function

Parameter	Description	Value
Value 2 bytes	The value type is set during operation with this parameter.	Value (0-255) * Temperature Brightness
Value (0-65535)	A fixed value can be assigned to the function with this parameter.	0 * ... 65535
Temperature	This parameter enables a fixed temperature value to be assigned to the function by means of a slider.	0 * ... 40°C
Brightness	This parameter enables a fixed brightness value to be assigned to the function by means of a slider.	0 * ... 1000 Lux

Table 40: Value 2 bytes function

i The "value 2 byte" function can only be used as a "Multiple function button" i.e. a rocker function is not possible here.

No.	Name	Object function	Length	Date type
106,118,130, 142,154,166, 178,190,202	Button 1 ... 9	Value (0-65535)	2 byte	7.001 DPT_Pulse
106,118,130, 142,154,166, 178,190,202	Button 1 ... 9	Brightness value	2 byte	7.001 DPT_Pulse
106,118,130, 142,154,166, 178,190,202	Button 1 ... 9	Temperature value	2 byte	7.001 DPT_Pulse

* Default value

Application description

KNX thermostat

KNX room controller

3.7.9 Priority function



The "Priority" function is configured in this section. This function allows a switch output to be forced to a switch position by a 2-bit telegram regardless of the ON/OFF object (higher priority). The priority function depends on the parameters set in the actuator.

i For further information, refer to the actuator description.

Figure 42: Priority function

Parameter	Description	Value
Operating concept	This parameter is used for determining the switching state of the actuator output when priority is activated.	Output activated * Output deactivated

Table 41: Priority function

i The "Priority" function can only be used as a "Multiple function button" i.e. a rocker function is not possible here.

Value		Behaviour of the output in the "ON" operating concept
Bit 1	Bit 0	
1	1	Priority ACTIVATED, actuator output activated
0	1	Priority DEACTIVATED, actuator output according to actuator configuration

Table 42: Priority behaviour when priority is "On"

Value		Behaviour of the output in the "OFF" operating concept
Bit 1	Bit 0	
1	0	Priority ACTIVATED, actuator output deactivated
0	0	Priority DEACTIVATED, actuator output according to actuator configuration

Table 43: Priority behaviour when priority is "Off"

No.	Name	Object function	Length	Data type
95,107,119,131, 143,155,167,179,191	Button 1 ... 9	Status indication priority	1 bit	1.011 DPT_Status
102,114,126 138,150,162,174, 186.198	Button 1 ... 9	Priority	2 bit	2.002 DPT_Boolean control

Example priority

The window cleaner function is an application that prevents a manual operation of the blind/roller shutter from being executed during the window cleaning. As a result, the blind/roller shutter operation is disabled from a central point. Blinds that have already been lowered are moved to the upper stop position. The manual blind/roller shutter function is also enabled from a central point.

Application description

KNX thermostat

KNX room controller

3.7.10 Scene function



In the following parameter window, the "Scene" function is parameterised and set as multiple function button in the using mode.

Figure 43: Scene function

The "Scene" function can be used as a scene extension and can be used to call up or save configured light scenes that are stored in other KNX devices. The device can call up and save a maximum of 64 scenes. Through a short key-press, the device transmits a value between 0 and 63 (where value 0 corresponds to scene 1 and value 63 corresponds to scene 64) to the bus via the scene communication object. The scene is called up when the button is released. This function allows scenes to be called up and saved. Up to 64 scenes can be called up by the device and saved by a long press of the button (set to 5 s by default).

Bit number							
7	6	5	4	3	2	1	0
Save	X	Scene number (0 ... 63; bit number 0 corresponds to = Scene1) * 26 = 64 scenes are to be used					

Table 44: Structure of 1-byte scene object

If the scene memorisation function is activated with a long key-press, the scene parameter values can be connected to the device and stored with a long key-press. Scene memorisation can also be deactivated with a long key-press (remove checkmark).

Parameter	Description	Value
Transmission delay	This parameter sets the delay time when the command is transmitted to the bus after pressing the touch control surface.	Immediate emission * 1 s - 5 min
Scene number	The scene number is set with this parameter.	1 * ... 64
Saving the scene by a long press of the button ^N	A changed scene can be saved again by activating this function by ticking the box.	

Table 45: Scene function

i The "scene" function can only be used as a "Multiple function button" i.e. a rocker function is not possible here.

No.	Name	Object function	Length	Data type
104,116,128 140,152,164, 176,190,202	Button 1 ... 9	Scene	1 byte	18.001 DPT_Scene control

* Default value

The "Deactivate automatic functions" function is described and presented in the following section. With this 1-bit communication object, automatic control sequences in the actuators can be deactivated. The actuator does not execute the next automatic switching event following the "Deactivate automatic control" command.

Thermostat type	Channel function	Automatic control deactivation
+ Display	Name of function	
+ Thermostat	Lock-up	<input type="checkbox"/>

Figure 44: deactivate automatic function

The "Automatic control deactivation" function is tested in the Hager/Berker system and is adapted to the switch actuators of the TXAxxx, TXBxxx and TXMxxx series.

No.	Name	Object function	Length	Data type
95,107,119,131,143,155,167,179,191	Button 1 ... 9	Automatic control deactivation status	1 bit	1.003 DPT_Enable
100,112,124,136,148,160,172,184,196	Button 1 ... 9	Automatic control deactivation	1 bit	1.003 DPT_Enable

i The "automatic control deactivation" function can only be used as a "Multiple function button" i.e. a rocker function is not possible here.

Example: Time-dependent outside lighting switching (Figure 45)

The outside lighting is switched on and off at a certain time every day of the week.

However, on certain occasions (garden parties) the outside lighting should stay on for longer. In this case, the "Automatic control deactivation" function is used to prohibit the time-dependent switching off of the outside lighting. To do so, a 1-bit command is transmitted to the bus.

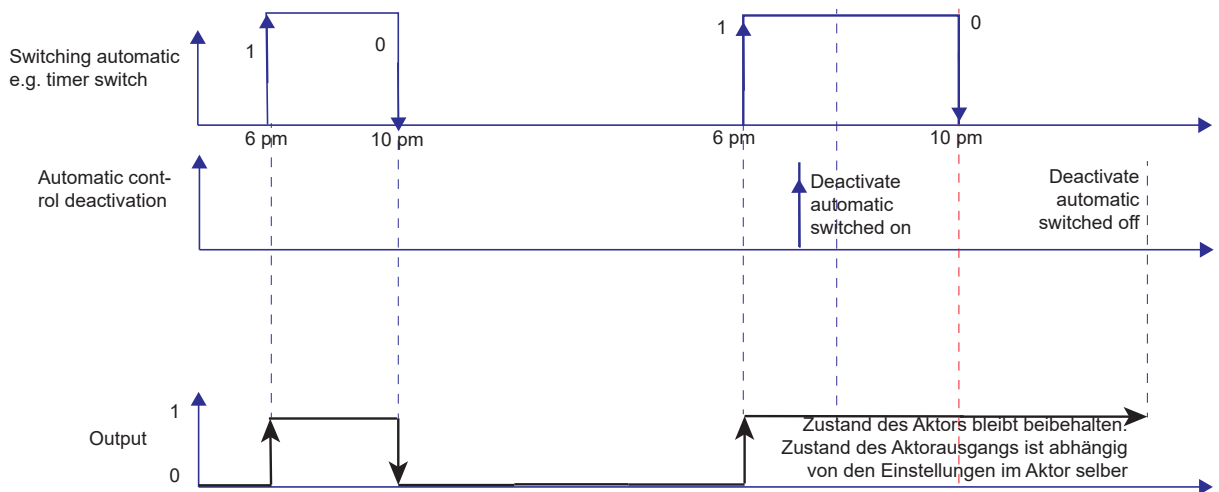

Figure 45: Automatic control function with switching/toggle commands

Application description

KNX thermostat

KNX room controller

3.7.12 Blocking function

The device has a blocking function (as described in section 3.4.6), that can be used to block individual push-button functions. To activate the blocking function for each button, the "blocking function" must be explicitly activated (checkmark set) in the "button x" parameter branch for each button.

The screenshot shows the configuration interface for a KNX thermostat. On the left, a tree view lists the configuration options: Thermostat type, Display, Thermostat, Internal temperature sensor, External temperature sensor, Push-button 1 (selected), Push-button 2, Push-button 3, Push-button 4, Push-button 5, and Push-button 6. The 'Function' sub-menu for 'Push-button 1' is active. The main configuration area on the right includes: 'Channel function' set to 'Shutter/blind', 'Closing type' set to 'Blind', 'Blind function' set to 'Up/down/stop rocker', and 'Name of page, long (full screen)' with an empty text field. At the bottom, the 'Lock-up' checkbox is checked and labeled with a red '1'.

Figure 46: Button - Blocking function

After bus voltage recovery, a lock-up remains active if it was activated before the bus voltage failed. The lock-up is always deactivated after a programming process by the ETS.

3.8 Info

The system information of the device, such as manufacturer, software version, date of last ETS download and the physical address are displayed in the Info menu.



In the ETS, the relevant device information can be viewed in the Info parameter.

The application version, database version and version of the translation file are displayed in the application software.

The screenshot shows the 'Info' menu in the ETS configuration software. It displays the following information:

Thermostat type	Application software version	1.2.0
+ Display	Version of translation file	1
+ Thermostat		
+ Internal temperature sensor		
+ External temperature sensor		
+ Push-button 1		
+ Push-button 2		
+ Push-button 3		

Figure 47: Info

4. Settings on the display

Once the devices have been parameterised via the ETS and put into operation, settings can also be changed on the display. For example, the setpoint temperature for heating/cooling can be changed or a new screen saver can be selected.

4.1 Basic display

The following information is displayed when the device is in standby mode

- the current room temperature,
- the current outside temperature,
- date or time,
- screen saver (analogue/digital clock, company logo, etc.)

In the "Display - General" parameter branch the settings must be set for the "basic display" page and standby operation.

The possible display information is described in more detail in the following sections.

4.1.1 Display of temperatures

The following temperatures can be displayed:

- current room temperature (determined via internal temperature sensor, or alternatively, via the connected, external temperature sensor in the case of larger rooms or also via an object)
- current outside temperature (determined via external temperature sensor)

The temperature display has a resolution of 0.5 °C and covers a range from - 30 °C to + 80 °C.

 After commissioning, voltage loss or download of the application software it can take up to 30 minutes until the device has adapted to the ambient temperature and the internal temperature sensor delivers correct measured values.

4.1.2 Display of date and time

The product has an internal clock. Time and date have to be set once in the settings during the initial setup. The time and data can also be set via the bus (weather station/ external timer). If the time is controlled via the internal clock, the parameter must still be set for changing to daylight serving time. Furthermore, the time format, 24h or 12 AM/PM, can be freely selected in both cases.

An external time signal should be transmitted regularly, e.g. hourly, in order to keep the rate deviation of the clock as small as possible. As long as no time and date information has been received via the objects, "--:--" appears in the display.

Application description

KNX thermostat

KNX room controller

4.2 Page Status

The page "Status" can only be parameterised via the ETS.

The state of the house can be displayed on the "Status" page. These status messages can be freely parameterised in the ETS. Messages can also be displayed via window contact query, overload, alarm messages and predefined user messages.

On the "Status" display page, a maximum of 3 status/user messages can be displayed simultaneously. The messages are displayed here by means of the priority list (Table 46).

Priority	Description
Priority 1 (highest priority)	State of the house (object 11)
Priority 2	Window open/close (object 22)
Priority 3	Overload (object 23)
Priority 4	Alarm message (object 6)
Priority 5	User message 1 (object 3)
Priority 6	User message 2 (object 4)
Priority 7 (lowest priority)	User message 3 (object 5)

Table 46: Priority Status message/User message

Page Status → display of the set status

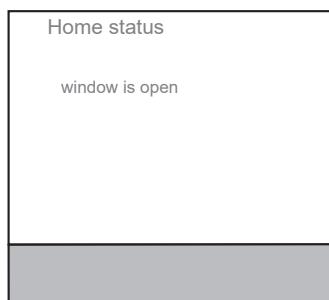

In the display, the status messages created in the ETS, such as "window open", are displayed.

Figure 48: Page Status messages

In Figure 48, an individually created status messages (window opened) is shown by way of example.

4.2.1 Display of user message

It is possible to display three in ETS predefined user messages with a maximum length of 20 characters on the display of the device. General information on the property management or text messages from alarm central units are possible, for example.

4.2.2 Display of status messages - State of the house

In the "State of the house" function, a data value can be displayed as text on the "Status" display page, such as CO2 value and temperature. The displayed value and type of display are defined in the ETS.

Status messages				
	1-Bit switching	1-Byte value	2-byte value	4-byte value
Example	Frontdoor open	TV 100 W	Cooker 2.4 kWh	Light 200000 Lx
Description	Frontdoor open	TV	Cooker	Light
Value	---	100	2.4	20000
Decimal place	---	---	1	0
Measuring unit	---	W	kWh	lx

Table 47: Examples of the display of possible "State of the house" configurations

Application description
KNX thermostat
KNX room controller
4.3 Page No problem

The "No Problem" page allows you to reset the device to one of the two last parameter settings saved. When the device is reset, the previous state is saved automatically.

Page No problem → Reset to settings of JJJJ/MM/DD

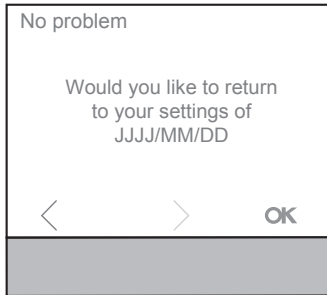

On the No Problem page, it is possible to reset the device to a setting variant that was parameterised previously. Firstly, the created ETS variant and the settings last changed on the display are saved.

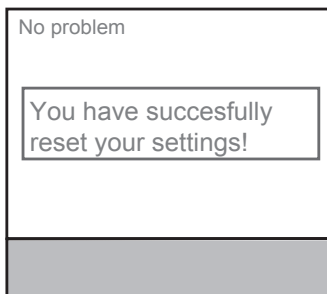
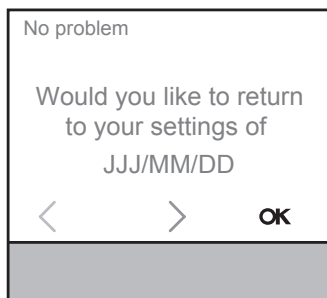

Confirmation after successful reset to the settings of YYYY/MM/DD.

Figure 49: Page No problem, display

Application description

KNX thermostat

KNX room controller

4.4 Page Settings





On the "Settings" page, the basic functions and parameters of the device are to be set/changed manually. The following parameters are to be configured under Settings:

4.4.1 Setpoint heating

On the display, the temperature setpoints are set for the Comfort, Standby and Night lowering operating modes.

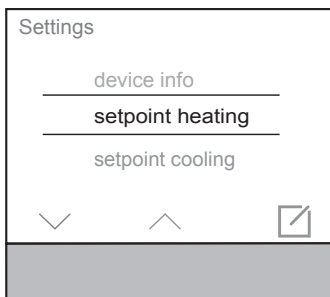
Settings page → Setpoint heating → Selecting operating mode



On the Settings page, select the "Setpoint heating" parameter using the arrow buttons \wedge / \vee and confirm with .

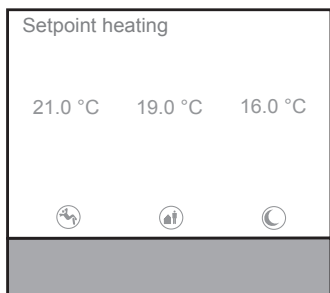



Under "Setpoint heating" select the operating mode whose assigned temperature setpoint should be changed. Night mode as an example.

- Swiping over the touch control surface. Return to the previous level.

 Presence

 Absence/Standby

 Night lowering

 Frost/heat protection

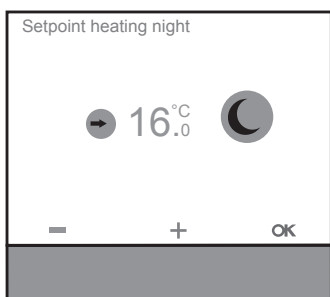

In the "Setpoint night heating" parameter, set the temperature setpoint using the + / - buttons and then confirm with **OK**.

- Swiping over the touch control surface. Return to the previous level.

Figure 50: Setpoint heating, operating mode night



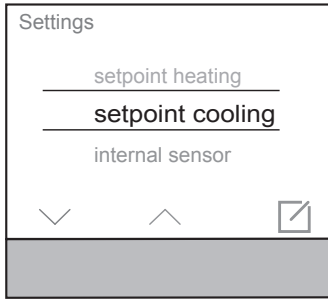

Application description
KNX thermostat
KNX room controller
4.4.2 Setpoint cooling

☐ Settings page → Setpoint heating → Selecting operating mode

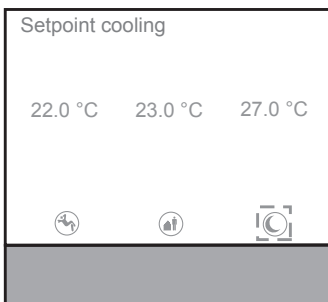

On the Settings page, select the "Setpoint cooling" parameter using the arrow buttons \wedge / \vee and confirm with .



- Under "Setpoint cooling" select the operating mode whose assigned temperature setpoint "Cooling" should be changed. Night mode as an example.
- Swiping over the touch control surface. Return to the previous level.
-  Presence
-  Absence/Standby
-  Night lowering
-  Frost/heat protection

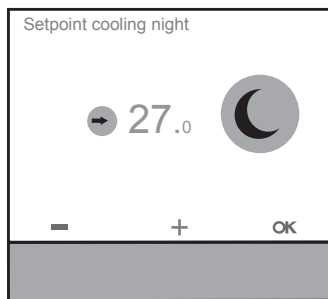

- In the "Setpoint night cooling" parameter, set the temperature setpoint using the + / - buttons and then confirm with OK.
- Swiping over the touch control surface. Return to the previous level.

Figure 51: Setpoint cooling, operating mode Night

Application description

KNX thermostat

KNX room controller

4.4.3 Internal sensor

Temperature adjustment of the internal sensor on the device.

- i** After approx. two days of operation at a constant room temperature, measure the room temperature again with a thermometer and adjust the temperature parameters accordingly on the device.

Page Settings → Internal sensor

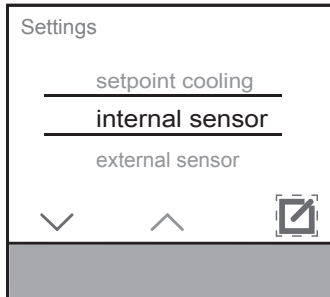

On the Settings page, select the "Internal temperature sensor" parameter using the arrow buttons \wedge / \vee and confirm with

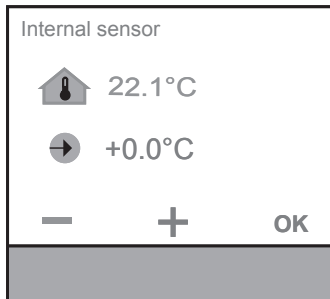

In the "Internal temperature sensor" parameter, set the temperature adjustment using the + / - buttons and then confirm with **OK**.

Figure 52: Internal temperature sensor, temperature adjustment

4.4.4 External sensor

Temperature adjustment of the external sensor on the device.

- i** After approx. two days of operation at a constant room temperature, measure the room temperature again with a thermometer and adjust the temperature parameters accordingly on the device.

Page settings → External temperature sensor

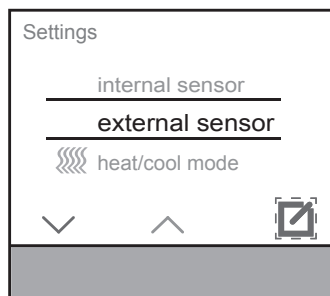

On the Settings page, select the "External temperature sensor" parameter using the arrow buttons \wedge / \vee and confirm with

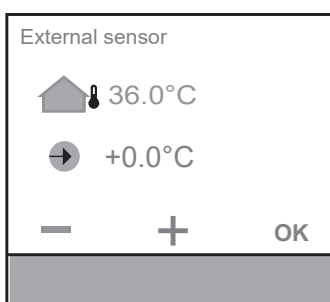

In the "External temperature sensor" parameter, set the temperature adjustment using the + / - buttons and then confirm with **OK**.

Figure 53: External temperature sensor, temperature adjustment



Application description

KNX thermostat

KNX room controller

4.4.5 Heating or cooling mode

In the Heating/cooling operation menu, the type of control for heating or cooling can be changed.

- Settings page → Heating/cooling operation → Heating operation  / Cooling operation 

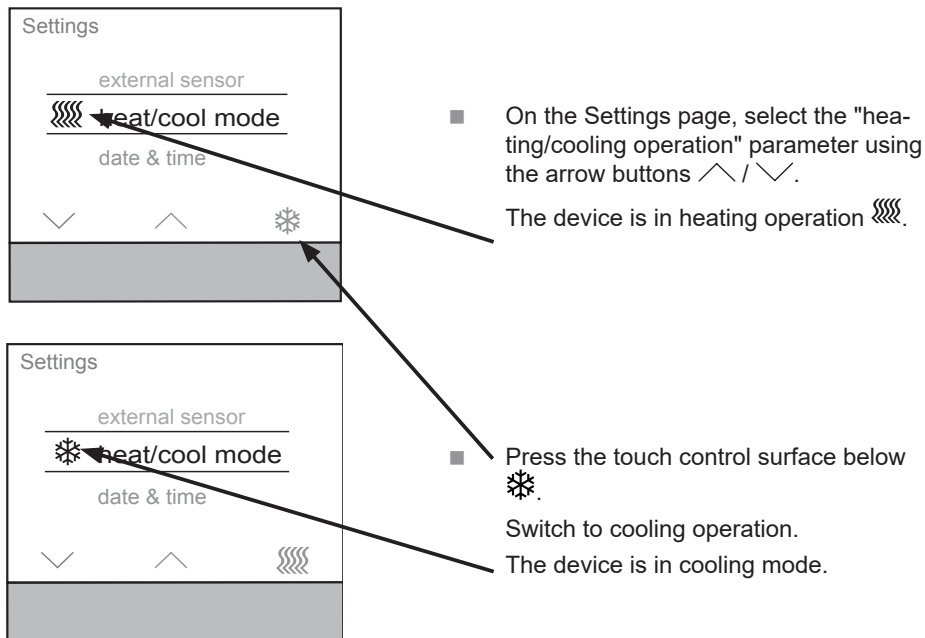

Figure 54: Heating or cooling mode

- i** If the "Automatic change-over between heating and cooling" was selected in the ETS, this menu item is hidden!

4.4.6 Date/time

In the Date/Time menu, the current date and time can be set manually. If the time is to be controlled internally, the time and date are set on the product. To do this, change to the "Settings" page by swiping your finger over the user interface and select the "Date / Time" menu item

- i** The current date and time are not set in the default state.

- Page Settings → Date/Time

Application description

KNX thermostat

KNX room controller

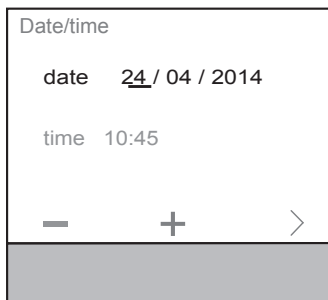

- In the Date/Time menu, first increase/decrease the respective underlined numerical value using + / - buttons in the "Date" parameter.
- Change to the next adjustable value with >.
- ⓘ To cancel the operation, simply swipe your finger over the user interface.
- ⓘ At the last value to be set, the display changes from > to **OK**.

Confirm inputs with **OK**.

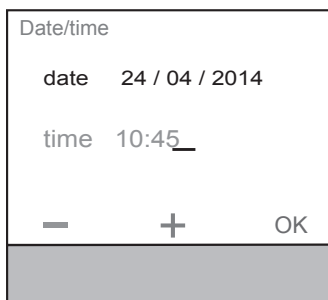
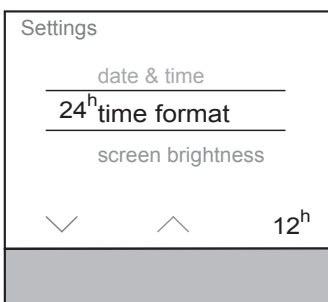

Figure 55: Date/time

4.4.7 24h/12h Time format

In the 24h/12h menu under Settings, the time can be displayed in 24h time format or 12h (AM/PM) time format.

Settings menu → Time format



- On the Settings page, select the "Time format" parameter using the arrow buttons ^ / v
- ⓘ The time is set in 24h time format in the default state.
- Press touch control surface below the display of **12^h**.

The time format changes from the 24h to 12h display.

In the function line appears **24^h**

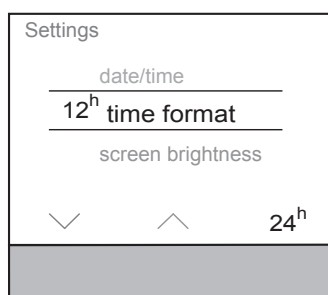

Figure 56: 24h/12h Time format

Application description

KNX thermostat

KNX room controller

4.4.8 Screen brightness



The display brightness can also be adjusted on the product itself. On the "Settings" page the brightness value can be readjusted via the "Brightness value" entry.

i The readjusted value is linked to the operation currently active (day / or night operation).

Settings page → Screen brightness

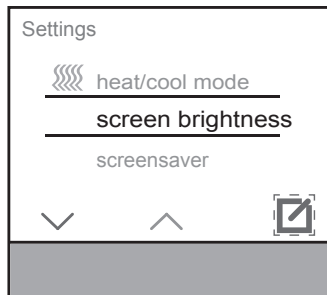

- In the Settings menu, select "Screen brightness" parameter using the arrow buttons \wedge / \vee and confirm with .



- Use + / -buttons to set the brightness value.
- Press **OK** or swipe your finger over the control surface to confirm.

Figure 57: Screen brightness

4.4.9 Screen saver

In the Screen Saver menu you can switch the function on/off and configure the display.

Settings menu → Screen saver

The screen saver display can be selected from six different display types.

- Analogue clock
- Digital clock
- Manufacturer logo
- Outdoor Temperature/time
- Room temperature/time
- Operation help
- Deactivated

Application description
KNX thermostat
KNX room controller

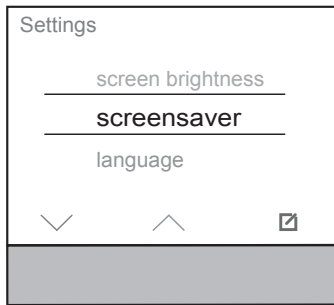

- On the Settings page, select the "Screen saver" parameter using the arrow buttons \wedge / \vee and confirm with \boxtimes .
The "Screen saver" menu opens.

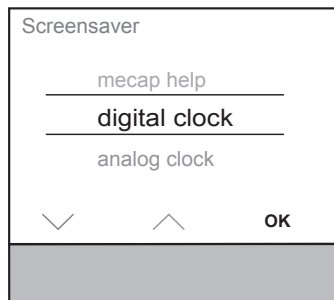

- In the "Screen saver" menu, select the "screen saver type" using the arrow buttons \wedge / \vee .
- Confirm with **OK**.

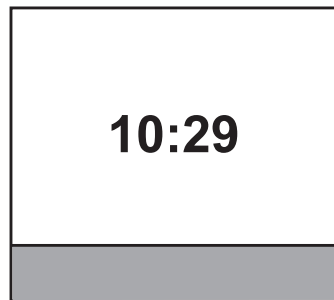

Example:

Screen saver has been selected as digital clock

The current time is displayed.

Figure 58: Screen saver

Application description

KNX thermostat

KNX room controller

4.4.10 Language

The language is selected under this setting.

Settings menu → Language

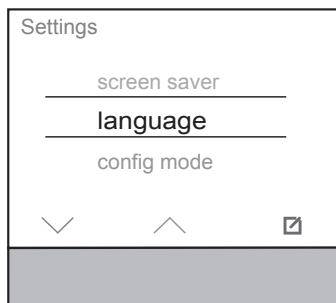

- On the Settings page, select the "Language" parameter using the arrow buttons \wedge / \vee and confirm with . Menu switches.



- In the Language menu, select the desired system language using the arrow buttons \wedge / \vee and confirm with **OK**. The selected system language is set.

Figure 59: Choice of language

4.4.11 Programming mode

On the Settings page after selecting the "Programming mode" menu item, you can load the physical address via the ETS.

At the factory this is 15.15.255

Menu setting → Programming mode

- Do not use the programming mode any longer after initial setup. The programming mode is used by qualified electricians/system administrators.

Application description

KNX thermostat

KNX room controller

4.4.12 Reset

In the Reset menu, the device can be reset to the factory settings. Any settings made will be lost. The parameter settings must be set once again and the device must be reprogrammed with the physical address.

Menu setting → Reset

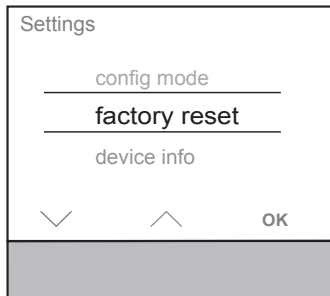

- In the Settings menu, select the "Reset" parameter using the arrow buttons \wedge / \vee and confirm with **OK**.
Menu switches.

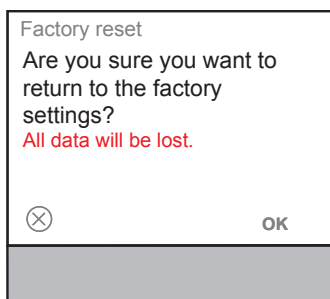

- The reset is performed by pressing the **OK** button > 10 seconds.
- You can exit the page without performing a reset by pressing \otimes .
The view switches back to the Settings menu.

Figure 60: Reset

4.4.13 Info

The system information of the device, such as manufacturer, software version, date of last ETS download and the physical address are displayed in the Info menu.

Menu setting → Info

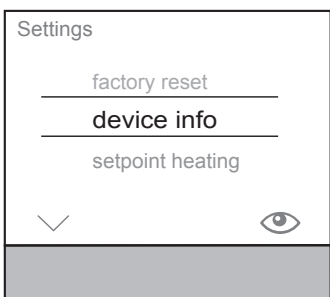

In the Settings menu, select the "Reset" parameter using the arrow buttons \wedge / \vee and confirm with \odot .

Menu switches.

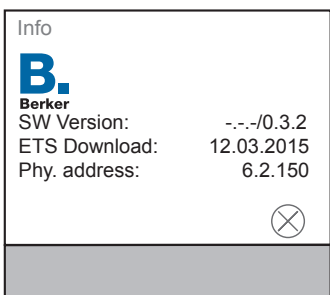

The following details are displayed on the Info menu page:

Manufacturer

Software version

Date last ETS download

Physical address

Exit the menu by pressing the press touch control surface \otimes .

Figure 61: Info

Application description

KNX thermostat

KNX room controller

4.5 Timer

On the "Timer" page you have to set on which weekdays or sections of the week and at what times the operating modes Comfort, Standby or Night mode (Night Reduction) are automatically switched.

Timer menu

i When delivered, the timer is switched off.

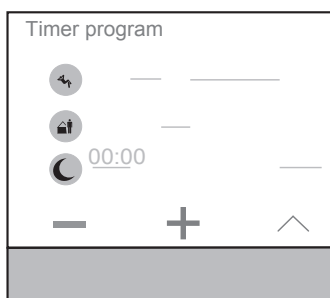
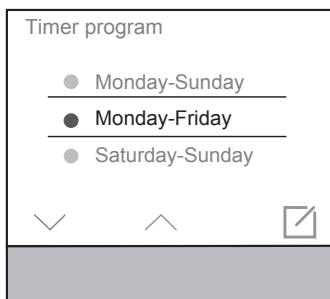
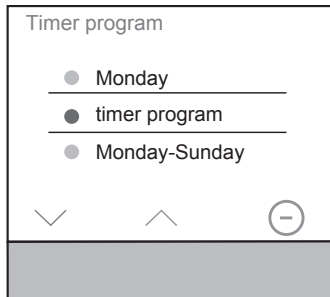

Select the timer parameter with \wedge / \vee .

Switch timer on/off using \ominus / \bullet .

f If the timer is activated, the set programming block is automatically executed once a week recurrently. If the timer is deactivated, adjustments to the temperature setpoint or operating mode must be set manually.

■ Select a section of the week or weekday with \wedge / \vee .

■ Confirm with

The display changes for setting the switching time.

The night operating mode is selected automatically.

If necessary change with \wedge to select another operating mode.

■ Set the switch-on/switch-off time with + / -

f The operation should be repeated for additional switching times.

■ Swipe your finger over the touch control surface.

The confirmation prompt is displayed. The display returns to the Timer submenu. The coloured circle next to the weekday or section of the week changes colour. Weekdays or sections of the week with the same coloured circles are configured with the switching times.

Figure 62: Timer

i The "self-learning heating curve" can be activated/deactivated on the timer in the "Optimisation" parameter. If the function is deactivated, the heating or cooling system will only be active at the set times.

The autonomously learning heating curve recognises the lead time required for reaching the desired room temperature. This saves a lot of energy, particularly in the transition period.

Thanks to "autonomous learning", the user settings are also saved and the heating/cooling system is controlled autonomously.

Application description

KNX thermostat

KNX room controller

4.6 Holiday mode

On the "Holiday mode" page, the set temperature can be lowered for periods of absence via the selected operating mode.

The holiday mode prevents heating/cooling during a long absence in order to save energy costs and to protect the environment. In the course of this, the number of days are first set on the holiday mode page and then the operating mode that should solely be active during this period.

If holiday mode is switched on, a suitcase symbol is displayed, the function of the timer is cancelled and any changes to the operating mode via the bus are not implemented. You can choose between three operating modes:

- Standby
 - Night operation (Economy)
 - Frost/heat protection mode
- Page Holiday mode



- On the holiday mode page, start the automatic control of the holiday mode with .

OR:

- on the holiday mode page, confirm the control surface . The menu switches to the Select operating mode menu.

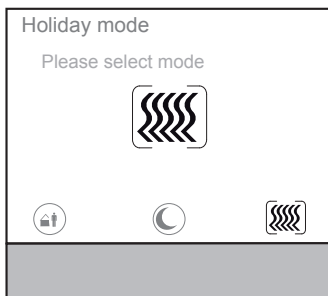

- On the holiday mode – operating mode page, select the required operating mode for the planned absence by pressing the touch control surface below the symbols. View switches.

- Standby
- Night operation (Economy)
- Heat protection mode
- Frost protection mode

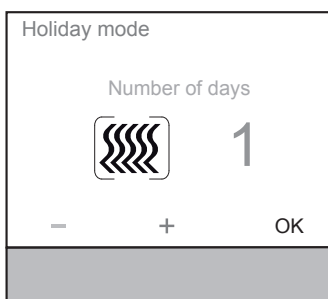

- Use the + / - buttons to set the number of days of the absence.
- As of firmware version 1.1.5, up to 255 days can be set for seasonal absence.
- Confirm with **OK**. View switches.

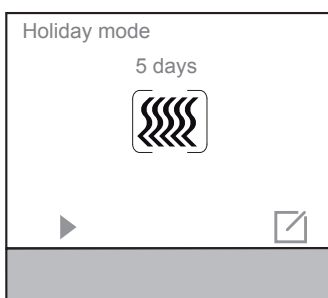

- On the holiday mode page, start the holiday mode with . Menu switches.

Application description

KNX thermostat

KNX room controller



- On the holiday mode page, stop the holiday mode with . The menu switches as shown in the previous figure.

Figure 63: Holiday mode

4.7 Page Operating mode

On the "Operating mode" page, you can select between three operating modes.

- Comfort
- Standby
- Night operation Economy

Operating mode changeover on display

The three operating modes comfort, standby and night operation are selected on the operating mode page.

Operating mode:

- Comfort (presence)
The Comfort operating mode sets the room temperature to a temperature value predefined in the thermostat e.g. comfort temperature 21°C for comfort (presence).
- Standby (absence)
The Standby operating mode reduces the room temperature after leaving the room to a value predefined in the thermostat (19°C, for example).
- Night operation
The night operation operating mode reduces the heating circuit temperature at night.

 With underfloor heatings, the change-over from is only noticeable after a certain period of time due to the sluggishness of the underfloor heating system with each setpoint adjustment.

Operating mode menu

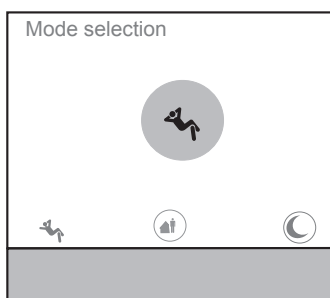

- On the operating mode page, select the required operating mode by pressing the touch control surface below the symbol.

The active operating mode is...

- displayed in the centre of the display highlighted in colour
- displayed without a border
- displayed in the status line of the basic display.

 Comfort (presence)

 Standby (absence)

 Night operation

Figure 64: Operating mode

Application description
KNX thermostat
KNX room controller
4.8 Page Extractor fan

Fan motors and extractor motors can be controlled manually or automatically on the "Extractor fan" page. In the case of manual control, fan speeds from 0 ... 6 can be set.

Fan speed page

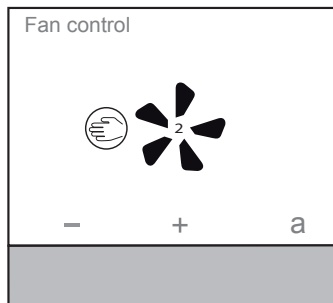

- On the fan speed page, increase/decrease the fan speed with + / -.
The number in the extractor fan symbol indicates the set stage.
- Press touch control surface a.
The fan function switches to automatic operation.
The  symbol provides the option of returning back to manual operation.

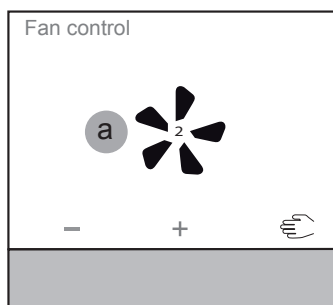

Figure 65: FanCoil/ventilation function

5. Room controller/push-button function

The touch control surface can be divided into two different functions.

- Touch operating surface as "Rocker" function
- Touch operating surface as "Multiple function button" function

An overview of all symbols displayed in the device is provided at [Appendix](#).

5.1 Function switching

In the "Switching" function, depending on the parameterisation an On or Off switching command is generated when the respective touch control surface is pressed (long or short press of the button).

5.1.1 Switching in "Rocker" function

The view shown in Figure 66 is displayed in the "Rocker, function, switching" function. Only one "Switchpoint" is displayed in this setting. Briefly press the button on the control surface beneath the symbol to switch on the lighting and briefly press the button beneath the symbol to switch it off.

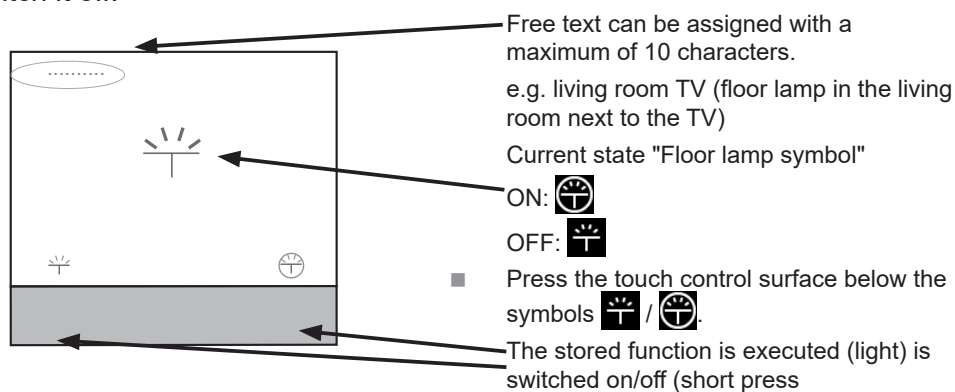

Figure 66: Switching, rocker function

5.1.2 Switching in "Button" function

In the "Rocker, function, switching" function, the view shown in Figure 67 is displayed. Up to three "Switchpoints" can be displayed in this setting. Briefly press the button on the control surface beneath the symbol to switch on the lighting and briefly press the button beneath the symbol to switch it off.

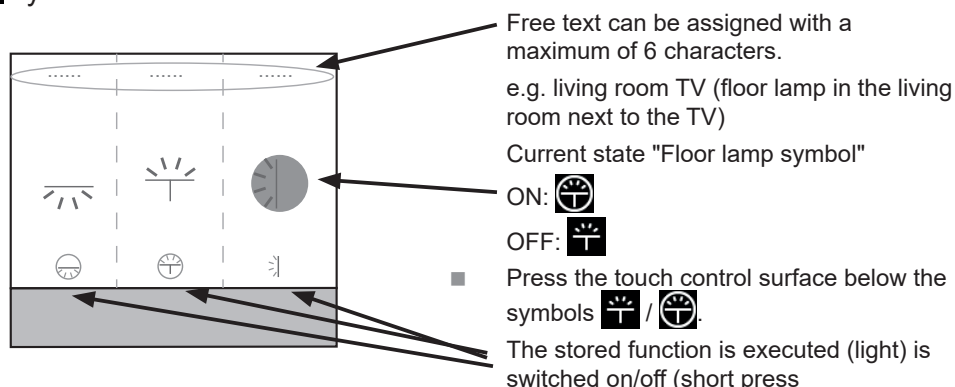

Figure 67: Switching button function

As shown in this example, the functions

- Light 1 ON (left)
- Light 1 off (middle)
- Light 2 on (right)

are permanently stored. This means that contrary to the toggle switch function, only the lighting switch on or off command is executed.

Application description

KNX thermostat

KNX room controller

Alternatively to the switching function in the rocker function, a maximum of three independent functions can be shown and switched on one display page.



Application description

KNX thermostat



KNX room controller

5.2 Toggle switch function



In the "Toggle switch" function a new state change of the output is generated each time the touch control surface is pressed. The state changes with each new press.

5.2.1 Switching in "Toggle switch" function

In the "Toggle switch" function, the view shown in Figure 68 is displayed. Up to three "Switchpoints" can be displayed in this setting. Briefly press the button on the control surface beneath the  symbol to switch on the lighting and briefly press the button beneath the  symbol to switch it off.

This function is different to simple switching as the same switchpoint switches ON or OFF, depending on the current state. The symbols change, depending on the current switching state. Only one switchpoint is needed for ON / OFF.

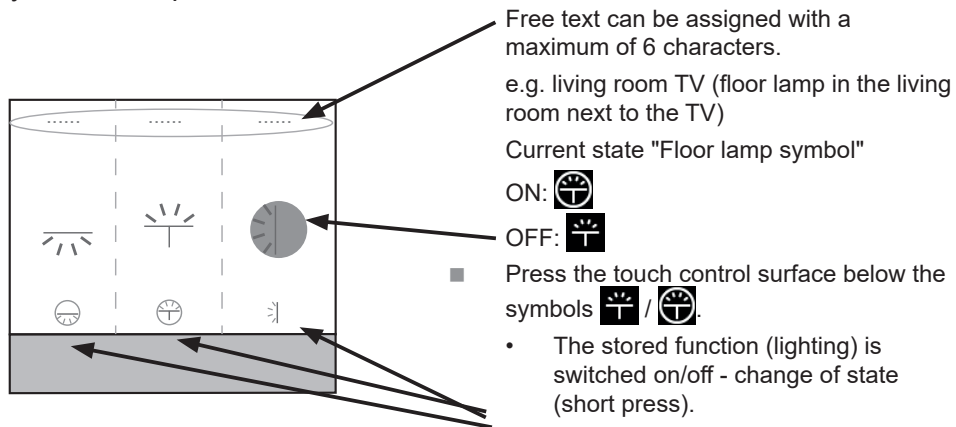

Figure 68: "Toggle switch" function

The "Dimming" function enables the device to increase and decrease the dimming in lighting circuits. This function can either be used as a rocker or as a button (during toggle mode).

5.3.1 Dimming in "Rocker" function

The view shown in Figure 69 is displayed in the "Rocker, function, switching" function. Only one "Switchpoint" is displayed in this setting.

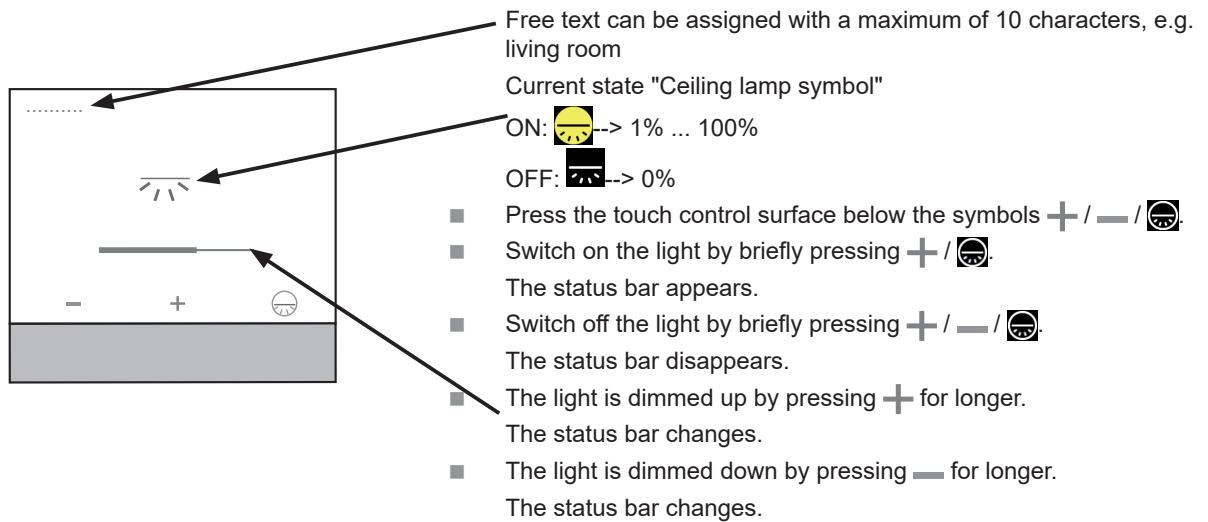

Figure 69: Dimmer rocker function

5.3.2 Dimming in "Button" function

The view shown in Figure 70 is displayed in the "Button - dimming function" function.

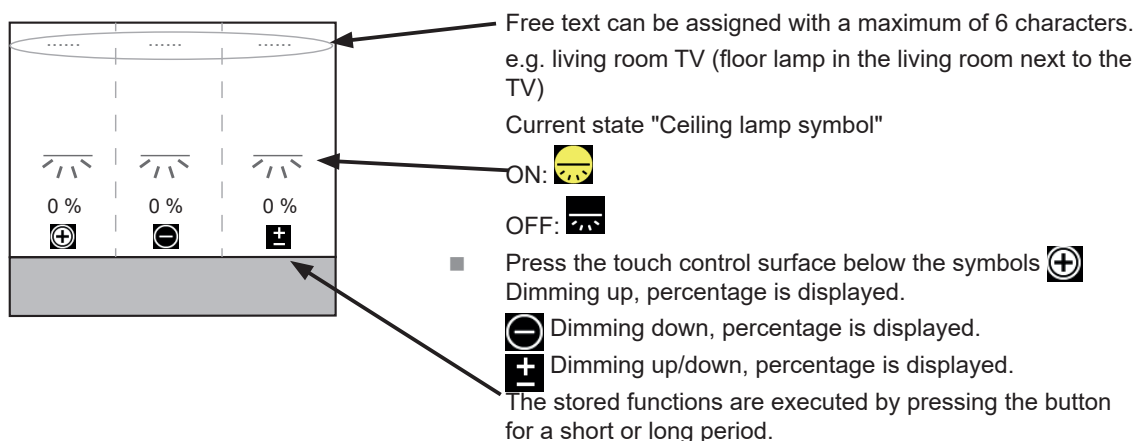

Figure 70: Dimming button function

Application description

KNX thermostat

KNX room controller

5.4 "Roller shutter/blind" function



You can control roller shutters, blinds, curtains or similar technical components with the "Roller shutter/blind" function.

5.4.1 Roller shutter/blind in "Rocker" function

The view shown in Figure 71 is displayed in the "Rocker - roller shutter/blind function" function. Only one "Switchpoint" is displayed in this setting. Press the button on the control surface beneath the \wedge / \vee symbol for longer to raise/lower the roller shutter/blind and stop the movement by briefly pressing the button beneath the symbols.

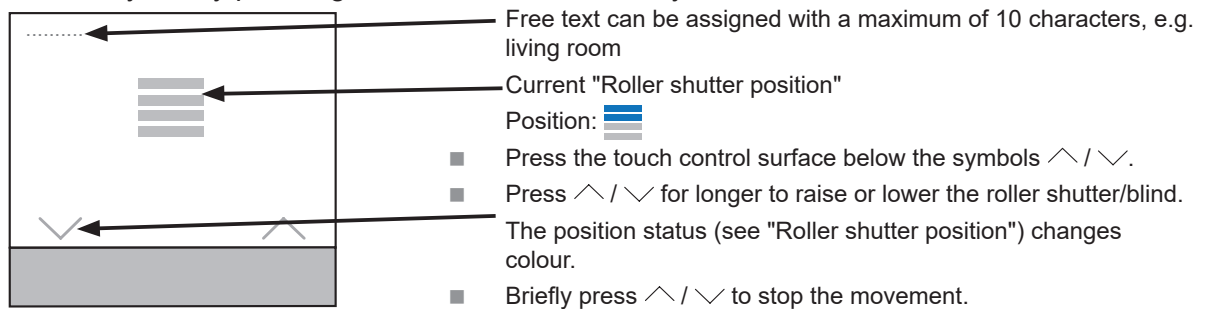

Figure 71: "Roller shutter/blind rocker" function

In inching mode, by briefly pressing the button, the

- roller shutter can be inched up/down
- slat position can be changed step by step.

Application description

KNX thermostat

KNX room controller

5.4.2 Roller shutter/blind in "Button" function



The view shown in Figure 72 is displayed in the "Button - roller shutter/blind function" function.

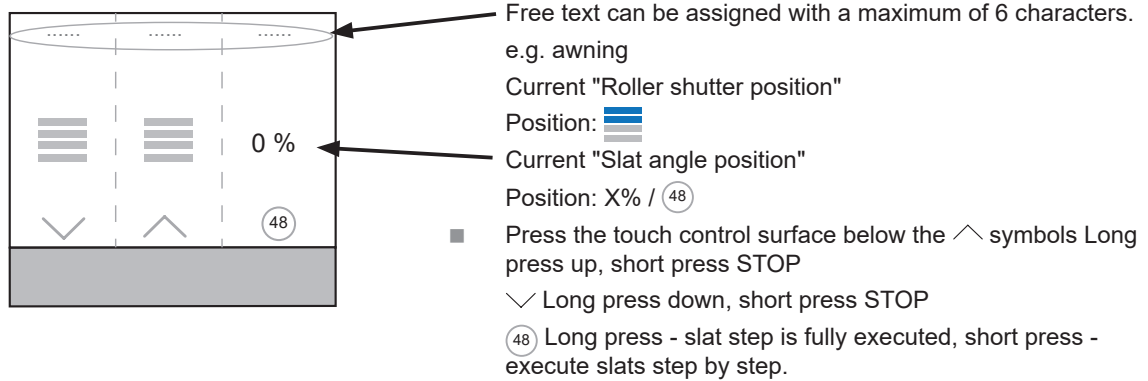
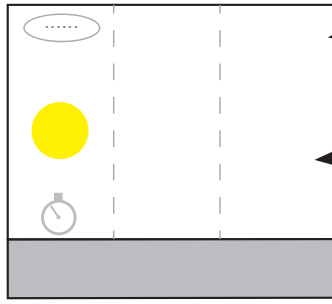



Figure 72: Roller shutter/blind button function

5.5.1 Timer in "Button" function

The view shown in Figure 73 is displayed in the "Button - timer function" function. The timer function can only be used as a "Button" function.

Free text can be assigned with a maximum of 6 characters.
e.g. cellar door light
Current "Lighting status"
Status: ● - Light on / ■ - Light off



- Press the touch control surface below the symbol . The time function set in the actuator is started with a short press.
By repeatedly and briefly pressing the button, the set time is added up and the interval extended (a maximum of 6 steps / 6 interval extensions are possible).
By pressing the button for longer, the time function set in the actuator can be terminated early.

A The "Maximum duplication of the switching interval (extend interval)" function can only be used with the actuators of the TYA... series.

Figure 73: Roller shutter/blind button function

5.6 Additional functions

Additional function to those described are available in the device.

- Value 1 byte / value 2 bytes
With these two functions, you can send a specified 1 Byte/2 Byte value to a switchpoint and trigger and action by pressing the button.
- Priority
The Priority function makes it possible to specify a defined state or to force a defined state of the function. (see also chapter 3.7.9).
- Scene
With this function, a light scene can be called up in a KNX device. A scene can have various functions e.g. light circuit 1 dimming, lower shutter 1, TV lighting ON, merge into a group (see also 3.7.10).
- Automatic control deactivation
This function can be used to interrupt and deactivate ongoing operations (time-controlled lighting) (see also chapter 3.7.11).

Application description

KNX thermostat

KNX room controller

6. ETS software characteristics



Product	Room thermostat	Room controller
Max. number of group addresses	254	254
Max. number of assignments	255	255
Objects	90	198

Table 48: ETS software characteristics

7. Technical data

KNX medium	TP 1
Configuration mode	S-Mode, E-Controller
Rated voltage KNX	24 V \pm +/- 6 % SELV
Auxiliary voltage	24 V \pm +/- 6 % SELV
KNX	max. current consumption 10 mA
Current consumption 24 V auxiliary voltage	25 mA
Connection mode KNX	KNX connecting terminal
Power reserve battery	\approx 4 h
Operating altitude	< 2000 m
Operating temperature	-5 to +45 °C
Storage/transport temperature	-25 ... +70 °C
Humidity	max. 60%<45°C, 90% at 45°C, no condensation
Screen diagonal	1.93"
Screen size	38.28 x 30.26 mm
Cable length ext. temperature sensor	max. 10 m
Degree of protection	IP21C
Impact protection	IK 04
Protection class	III
Test mark	KNX, CE
Electric strength	4 KV
Overvoltage category	III
Degree of contamination	2
Control function	class A
Mode of action	type 2
Ball pressure test	at 75 °C
Standards	EN 60730-2-9, EN 50491-3 EN 50491-5-2

8. Accessories

Cover for KNX thermostat with display	WKT960X
Temperature sensor	EK090, EK089, EK088
KNX power supply 320 mA + 24 V \pm , 640 mA	TXA114
Power supply 24 V \pm	TGA200

9.1 Heating and cooling control types

The control types are designed for heating and cooling. The temperature setpoints are freely configurable in the software for both systems.

If the setpoints are exceeded or undershot, a reaction is caused in the connected heating actuator or the connected valve drive.

Device type	Cycle time [min]	Proportional range [K]	Integration time [min]	Differential time [min]
Hot water heating	10	3	20	20
Warm water underfloor heating	20	2	30	20
Electric heating	10	4	10	10
Electric underfloor heating	20	2	30	20
Convactor fan	10	5	10	10
split unit	10	5	10	10
Cooling ceiling	20	2	30	20
Convactor fan	10	5	10	10
split unit	10	5	10	10

Table 49: Predefined control parameters

9.1.1 Automatic change-over heating/cooling

During the automatic change-over from heating to cooling, temperature ranges are defined for the different heating and cooling devices. In the Near the thresholds (proportional range), no change-over takes place yet to the other control type. However, if the value exceeds and/or falls below this range, the device only changes over to the other control type if "automatic change-over" is activated.

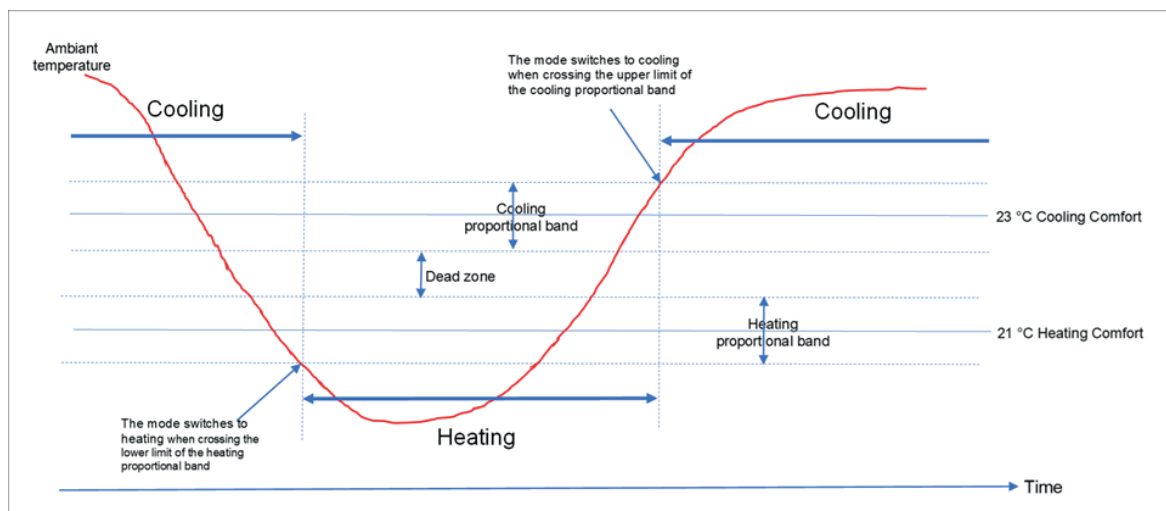

Figure 74: Automatic change-over heating/cooling

The 2-point control or the 2-point controller is the simplest of the two controller types in terms of operation. The controller can only switch the heating/cooling on or off. The controller switches the output value on if the setpoint is undershot, or turns it off if the setpoint is exceeded (heating) (Figure 75).

The controller is equipped with an in-built hysteresis in order to prevent the it from constantly switching the output value on and off. The controller calculates the switch-on and switch-off points using the hysteresis and the current setpoint. The hysteresis value is also stored permanently and cannot be changed.

The 2-point controller should be used where the output value can only accept the two states ON or OFF and the actual temperature does not have to be controlled precisely to the setpoint.

Due to the inertia of the heating system, the actual temperature swings slightly below the set switch-on point and exceeds the set switch-off point slightly. The actual temperature therefore always fluctuates in the 2-point controller within a range which is slightly greater than the set hysteresis.

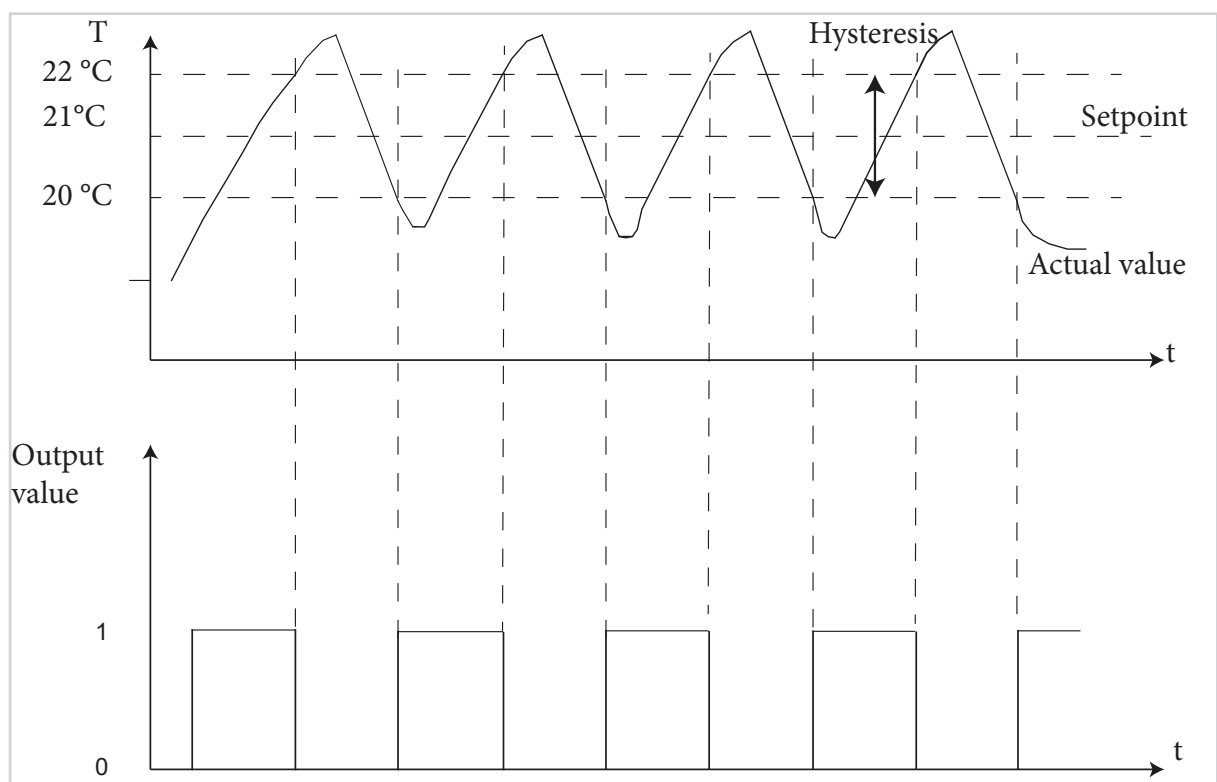

Figure 75: 2-point control

9.1.3 Continuous PID control

In the steady PID control, the output signal (0 ... 100%) of the PID control is forwarded directly as command value. It is suitable for drives that can set a variable command value of 0-100%.

9.1.4 Switching PID control (PWM)

The switching PID control (PWM), pulse wide modulation control, also has continuous PID control. However, with such control the output signal (0 ... 100%) of the PID control is not forwarded to the command value, but is processed internally only. The PWM control subsequently converts the output value from the output signal of the PI control into a switch on/off pulse. However, this switch on/off pulse does not have a fixed switch on/off point as with the 2-point control, but the length of the pulses is determined by means of the output value calculated by the PID control (cycle time). The larger the calculated output value of the PID control, the greater is the ratio of the switch on/off times.

Application description

KNX thermostat

KNX room controller



In the PWM control, the cycle time can be set with the "Through control parameter" parameter. The cycle time is the time which comprises a cycle, that is to say the duration of a switch on/off pulse (Figure 76). The duration of the switch-on pulse is calculated from the product of the calculated output value and cycle time, e.g. if the cycle time is 10 min and the calculated output value is 70%, the switch-on pulse is $0.7 \cdot 10 \text{ min} = 7 \text{ min}$. The remaining three minutes of the cycle therefore remain for the switch-off pulse. A short cycle time causes the switch-on pulses to occur at short intervals. This prevents the temperature from sinking too much and the actual value remains largely stable. However, this can also lead to frequent switching pulses, which can adversely affect the system or can overload the bus.

The application area of the PWM control is where the advantages of the continuous PID control are required, but the heating system used can assume only the two states ON and OFF. The PWM control provides fairly good control results because it retains the advantages of continuous PID control (control to desired setpoint, no overshoot) in spite of limited switching states. One area of application is, for example, electro-thermal drives.

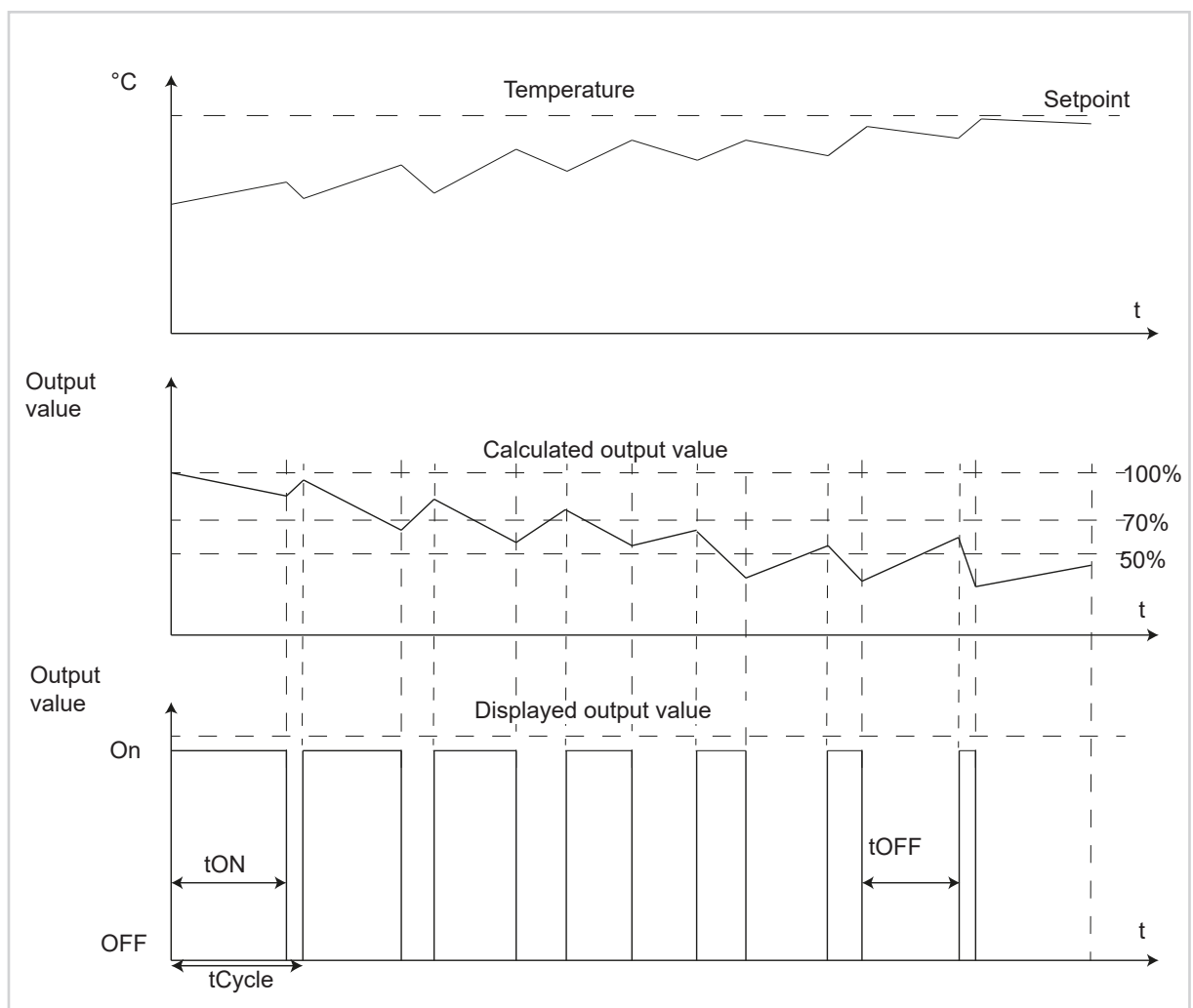

Figure 76: Switching PI-control (PWM)

Application description

KNX thermostat

KNX room controller

Table of Figures

Figure 1: System overview	6
Figure 2: Display elements	7
Figure 3: Operating concept "Push-button operation"	7
Figure 4: Operating concept "Slider operation"	8
Figure 5: Selection device variant	12
Figure 6: General settings	15
Figure 7: User messages	17
Figure 8: Time	18
Figure 9: Basic display	19
Figure 10: State of the house	20
Figure 11: Overview "Configuration status message"	22
Figure 12: Blocking function	23
Figure 13: Time setting for long push-button action	24
Figure 14: Overview heating/cooling variants	25
Figure 15: Settings "General - room thermostat"	26
Figure 16: Overview diagram "Operating mode change-over via object with presence object" (4x1 bit)	31
Figure 17: Overview diagram "Operating mode change-over via object with presence detector" (4x1bit)	32
Figure 18: Room thermostat - Basic heating	36
Figure 19: Room thermostat - Additional heating	37
Figure 20: Room thermostat - Basic cooling	38
Figure 21: Room thermostat - Additional cooling	39
Figure 22: Temperature measurement settings	40
Figure 23: Fan Coil/ventilation function	43
Figure 24: Transmission behaviour if value changes	47
Figure 25: Setpoint Settings	48
Figure 26: Room thermostat „Setpoint shift“	51
Figure 27: Scene settings	52
Figure 28: Internal temperature sensor settings	53
Figure 29: External temperature sensor settings	54
Figure 30: Settings of push-button functions	55
Figure 31: Button "Operating concept"	56
Figure 32: Multiple function button	57
Figure 33: Button Rocker function	57
Figure 34: Toggle switch function	58
Figure 35: Function switching	59
Figure 36: Function Dimming	60
Figure 37: Function shutter	61
Figure 38: Function blind	62
Figure 39: Timer function	64
Figure 40: Function value transmitter 1 byte/2 byte	65
Figure 41: Value 2 bytes function	66
Figure 42: Priority function	67

Application description

KNX thermostat

KNX room controller

Figure 43: Scene function	68
Figure 44: deactivate automatic function	69
Figure 45: Automatic control function with switching/toggle commands	69
Figure 46: Button - Blocking function	70
Figure 47: Info	70
Figure 48: Page Status messages	72
Figure 49: Page No problem, display	73
Figure 50: Setpoint heating, operating mode night	74
Figure 51: Setpoint cooling, operating mode Night	75
Figure 52: Internal temperature sensor, temperature adjustment	76
Figure 53: External temperature sensor, temperature adjustment	76
Figure 54: Heating or cooling mode	77
Figure 55: Date/time	78
Figure 56: 24h/12h Time format	78
Figure 57: Screen brightness	79
Figure 58: Screen saver	80
Figure 59: Choice of language	81
Figure 60: Reset	82
Figure 61: Info	82
Figure 62: Timer	83
Figure 63: Holiday mode	85
Figure 64: Operating mode	85
Figure 65: FanCoil/ventilation function	86
Figure 66: Switching, rocker function	87
Figure 67: Switching button function	87
Figure 68: "Toggle switch" function	89
Figure 69: Dimmer rocker function	90
Figure 70: Dimming button function	90
Figure 71: "Roller shutter/blind rocker" function	91
Figure 72: Roller shutter/blind button function	92
Figure 73: Roller shutter/blind button function	93
Figure 74: Automatic change-over heating/cooling	95
Figure 75: 2-point control	96
Figure 76: Switching PI-control (PWM)	97

Application description

KNX thermostat

KNX room controller

List of Tables

Table 1: ETS Software version	9
Table 2: ETS Application designations	9
Table 3: Selection device variant	12
Table 4: General Settings	16
Table 5: User messages	17
Table 6: Time	18
Table 7: Page "Basic display"	19
Table 8: State of the house	21
Table 9: Priority Status message/User message	22
Table 10: Examples Status messages	22
Table 11: Blocking function	23
Table 12: Time setting for long push-button action	24
Table 13: Settings "General - room thermostat"	27
Table 14: Settings "General - Room thermostat - Heating"	28
Table 15: Operating mode change-over via object with presence object	31
Table 16: Operating mode change-over via object with presence object with presence detector	32
Table 17: Operating mode switch-over via object (1 byte) with priority of 2-bit object	32
Table 18: Room thermostat - Basic heating	36
Table 19: Room thermostat - Basic cooling	38
Table 20: Temperature measurement settings	42
Table 21: Function „Ventilation“	44
Table 22: Fan speed "Switching object 1-bit"	45
Table 23: Fan speed "Value object" (1 byte)	46
Table 24: Transmission settings	47
Table 25: Heating setpoints	49
Table 26: Cooling setpoints	49
Table 27: Setpoint Settings	50
Table 28: Room thermostat „Setpoint shift“	51
Table 29: Scene settings	52
Table 30: Internal temperature sensor settings	53
Table 31: External temperature sensor settings	54
Table 32: Settings of push-button functions	55
Table 33: General button parameters	56
Table 34: Toggle switch function	58
Table 35: Function switching	59
Table 36: Function Dimming	60
Table 37: Function shutter	61
Table 38: Function blind	62
Table 39: Value transmitter 1-byte function	65
Table 40: Value 2 bytes function	66
Table 41: Priority function	67
Table 42: Priority behaviour when priority is "On"	67

Application description

KNX thermostat

KNX room controller

Table 43: Priority behaviour when priority is "Off"	67
Table 44: Structure of 1-byte scene object	68
Table 45: Scene function	68
Table 46: Priority Status message/User message	72
Table 47: Examples of the display of possible "State of the house" configurations	72
Table 48: ETS software characteristics	94
Table 49: Predefined control parameters	95



ATC Main area, big icons (88x88px)



Fan stopped



Fan stopped



Fan running



Fan running

ATC Main area, normal (62x62px)



Output status on



Output status off



Ceiling lamp status on



Ceiling lamp status off



Standing lamp status on



Standing lamp status off



Wall lamp status on



Wall lamp status off

value = line

value = % value

Dimming brightness value

Dimming brightness value



Shutter bar (filled)



Slat bar (filled)

value

Value transmitter



Forced on active



Forced on inactive



Forced off active

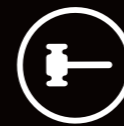

Forced off inactive



Scene (learn or play)



Automatism active



Automatism inactive



Comfort mode



Standby mode



Eco mode



Frost protection mode



Heat protection mode



Screen brightness

value = line

Screen brightness level



Config on

hager

Hager logo

**B.
Berker**

Berker logo

ATC Main area, small (28x28px)



Setpoint temperature comfort



Setpoint temperature comfort up



Setpoint temperature comfort down



Setpoint temperature comfort standby



Setpoint temperature comfort standby up



Setpoint temperature comfort standby down



Setpoint temperature eco



Setpoint temperature Eco Up



Setpoint temperature Eco down



Setpoint temperature Protection



Setpoint temperature protection up



Setpoint temperature protection down



Outdoor temperature



Fan Auto Active



Fan Auto Active



Forced active



Comfort lenthening



Vacation active



Window open



Comfort mode small



Standby mode small



Eco Mode small



Comfort mode small not selected



Standby mode small not selected



Eco mode small not selected



Room temperature / Internal sensor



Floor temperature / External sensor



Temperature offset



Cooling small



Heating small

12^h

AM/PM format small

24^h

24h format small



Enable



Disable



ETS : Easy backup settings



User backup settings



Comfort lenthening on (Presence)



Comfort lenthening off (Absence)



Switch on



Switch off



Switch ceiling lamp on



Switch ceiling lamp off



Switch standing lamp on



Switch standing lamp off



Switch wall lamp on



Switch wall lamp off



Switch off / dim down



Switch off / dim up



Switch toggle / dim down



Switch toggle / dim up



Switch toggle / dim toggle



Move up (safety)



Move down (safety)



Timed on (start)



Timed toggle (start)



Value transmitter



Forced on active



Forced on inactive



Forced off active



Forced off inactive



Scene (learn or play)



Automatism active



Automatism inactive



Fan mode auto



Fan mode manual



Comfort mode



Standby mode



Eco mode



Comfort mode selected



Standby mode selected



Eco mode selected



Start



Stop



Frost protection mode



Heat protection mode



Decrease a value



Increase a value



Select previous value



Select next value



Select upper value



Select lower value



Enable



Disable



Edit



View



Next page (in sequence)



OK (save and exit sequence)



back (exit sequence)



close (close popup message)



Heat mode



Cool mode



AM/PM format



24h format



Config mode on



Config mode off



Lock mode



Comfort mode



Standby mode



Eco mode



Frost protection mode



Heat protection mode



Forced active



Timer active



Dew point active



setpoint modified



cooling



Heating



Cooling active



Heating Active



Locked



Vacation active



Window Open