

	<h2 style="margin: 0;">application software</h2>	
<ul style="list-style-type: none"> ▲ Manufacturers ▲ Hager Electro ▲ Lighting <li style="background-color: #e0f0e0; padding: 2px;">▲ Dimmer 	<p style="margin: 0;">Dimmer KNX: 1, 3 and 4-fold</p> <p style="margin: 0;"><i>Electrical/Mechanical characteristics: see product user manual</i></p>	

	Product reference	Product designation	Application software ref	TP device Radio device
	<p>TYA661A</p> <p>TYA661B</p>	<p>1-fold dimming actuator 300W, universal</p> <p>1-fold dimming actuator 600W, universal</p>	<p>STYA661 1.x Version</p>	
	<p>TYA663A</p>	<p>3-fold dimming actuator 300W, universal</p>	<p>STYA663 1.x Version</p>	
	<p>TYA664A</p>	<p>4-fold dimming actuator 300W, universal</p>	<p>STYA664A 1.x Version</p>	

Content

1. General	4
1.1 About this guide	4
1.2 About the program	4
1.2.1 ETS compatibility	4
1.2.2 Application descriptions	4
2. General Description	5
2.1 Installation of the device	5
2.1.1 Overview presentation	5
2.1.2 Connection	6
2.1.3 Physical addressing	7
2.2 Function modules of the application	8
2.2.1 Primary functions	9
2.2.2 Additional functions	10
3. Parameters	11
3.1 Definition of the general parameters	11
3.1.1 Manual mode	11
3.1.2 Activation of the Status indication	12
3.1.3 Activation of the logic blocks	12
3.1.4 Activation of the Device diagnosis object	12
3.1.5 Restore ETS-Parameters	13
3.1.6 Status during bus power cut or download	14
3.1.7 LED display	15
3.2 Manual mode	16
3.2.1 Duration of manual mode activation	16
3.2.2 Deactivation of manual mode	16
3.2.3 Status indication manual mode	17
3.2.4 Status after manual mode	18
3.3 Status indication	19
3.4 Logic block	22
3.4.1 Configuration of the Logic function	24
3.4.2 Logic block authorization	25
3.4.3 Logic result	27
3.5 Diagnosis	30
3.6 Function selection	32
3.6.1 Definition	33
3.6.2 ON/OFF timings function	41
3.6.2.1 Delays for ON/OFF objects	41
3.6.2.2 Timer/toggle switch changeover for ON/OFF object	43
3.6.2.3 Time limited toggle switch	44
3.6.3 Timer	45
3.6.3.1 Timer operation	45
3.6.3.2 Cut-OFF pre-warning	48
3.6.3.3 Configuration	49
3.6.4 Scene	50
3.6.5 Preset	56
3.6.6 Lock-up	62
3.6.7 Priority	67
3.6.8 Hours counter	70
3.6.9 Notifications	73
3.6.9.1 Dimming mode	73
3.6.9.2 Overload	74
3.6.9.3 Short circuit	75
3.6.9.4 Over voltage	75
3.6.9.5 Over temperature	76
3.6.9.6 Load default	77

4. Communication objects.....	78
4.1 Communication objects General	78
4.1.1 Manual mode	78
4.1.2 Logic block	79
4.1.3 Behaviour of the device.....	80
4.1.4 Diagnosis	81
4.2 Output communication objects	82
4.2.1 ON/OFF.....	85
4.2.2 Dimming	85
4.2.3 Load memorisation.....	86
4.2.4 ON/OFF timings function.....	87
4.2.5 Status indication.....	88
4.2.6 Timer.....	88
4.2.7 Scene	89
4.2.8 Preset.....	90
4.2.9 Lock-up	91
4.2.10 Priority	92
4.2.11 Hours counter.....	93
4.2.12 Notifications.....	94
5. Appendix	96
5.1 Specifications	96
5.1.1 TYA661A/B	96
5.1.2 TYA663A.....	97
5.1.3 TYA664A.....	97
5.2 Table of logical operations.....	98
5.3 Characteristics	98

1. General

1.1 About this guide

The purpose of this manual is to describe the operation and configuration of the KNX-devices using the ETS program. It consists of 4 parts:

- General information.
- Parameter description.
- Overview of KNX objects.
- Technical characteristics.

1.2 About the program

1.2.1 ETS compatibility

The application programs are compatible with ETS4 and ETS5. They can be downloaded from our website under the order number.

ETS Version	File extension of compatible files
ETS4 (V4.1.8 or higher)	*.knxprod
ETS5	*.knxprod

1.2.2 Application descriptions

Application	Product reference
STYA661	TYA661A/B
STYA663	TYA663A
STYA664A	TYA664A

2. General Description

2.1 Installation of the device

2.1.1 Overview presentation

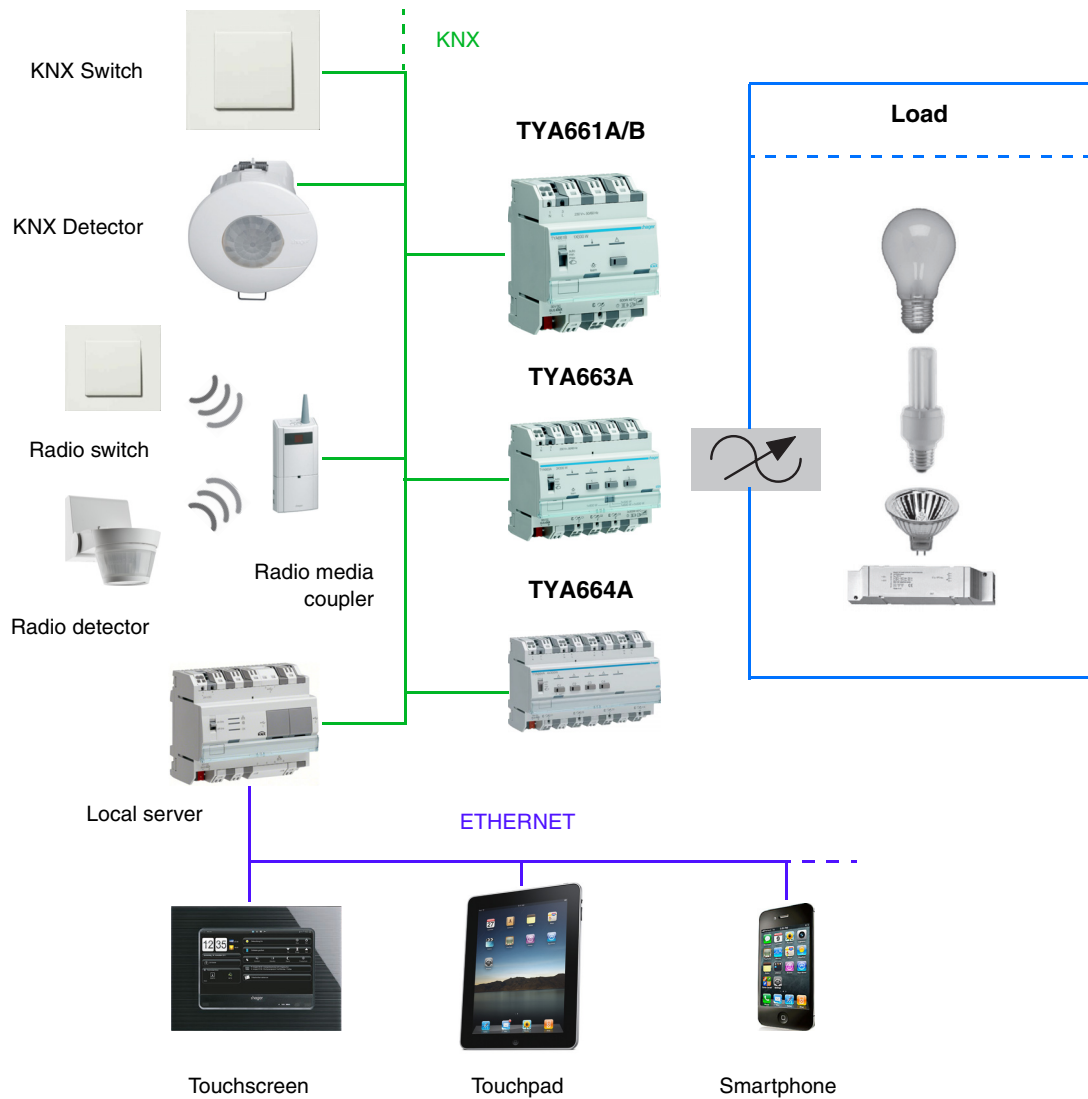

2.1.2 Connection

TYA661A/B

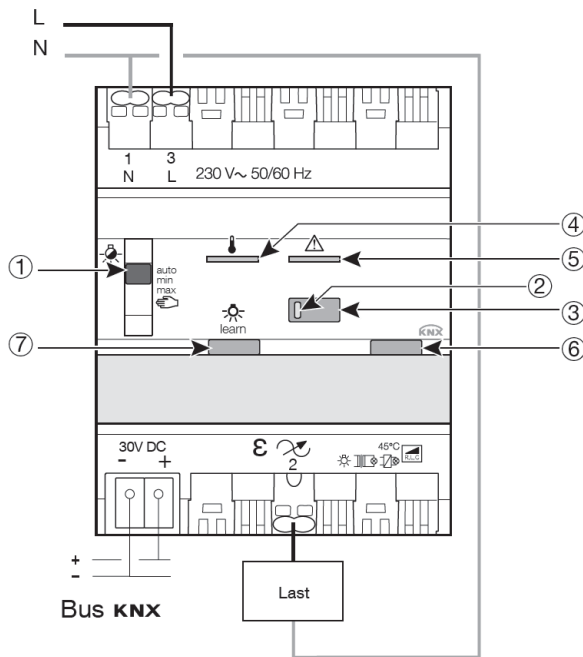

- ① • auto/min/max/manu switch
- ② • Indicator state
- ③ • Local command pushbutton
- ④ • Overheating indicator
- ⑤ • Short circuit and overload indicator
- ⑥ • Physical addressing lighted push button
- ⑦ • Dimming mode override push button

TYA663A

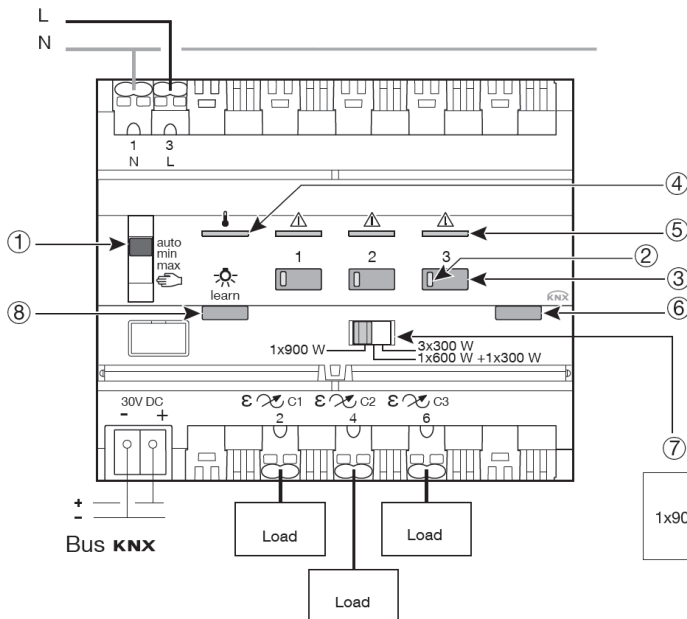

- ① • auto/min/max/manu switch
- ② • Indicator state
- ③ • Local command pushbuttons
- ④ • Overheating indicator
- ⑤ • Short circuit and overload indicator
- ⑥ • Physical addressing lighted push button
- ⑦ • Selection of the number of outputs
- ⑧ • Dimming mode override push button

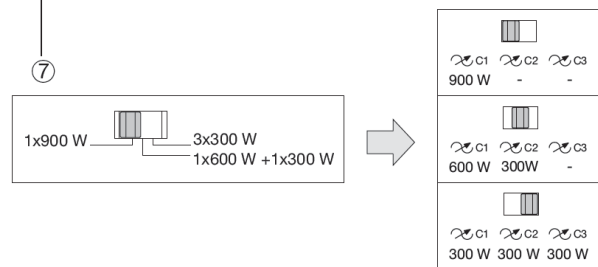

TYA664A

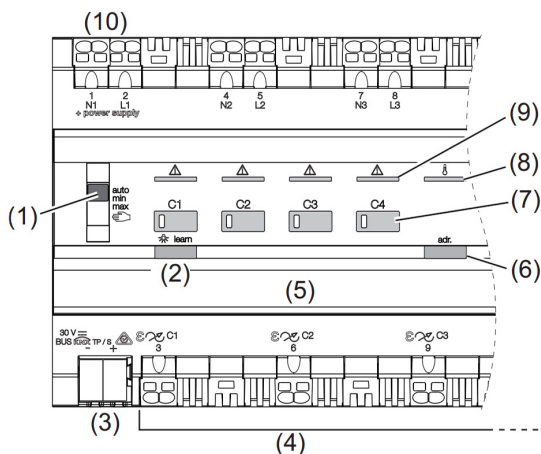

- (1) Slide switch **auto/min/max**
- (2) Illuminated button for dimming mode
- (3) KNX bus connection terminal
- (4) Connection of load
- (5) Labelling field with cover
- (6) Illuminated programming button
- (7) Operation button for manual operation with status LED
- (8) Control LED overheating protection
- (9) Control LED short-circuit and overload protection per output
- (10) Mains connection

Note: The Min and Max settings are used to set the lowest and highest lighting levels for the outputs. These settings are achieved by storing the current output values through a long press on the relevant buttons next to the output on the front of the device.

2.1.3 Physical addressing

In order to perform the physical addressing or to check whether or not the bus is connected, press the lighted push button (6) on the right-hand side above the identification plates on the front of the device.

Light on = bus connected and ready for physical addressing.

Programming mode is activated, until the physical address is transferred from ETS. Pressing the button again, exits programming mode. Physical addressing can be carried out in automatic or manual mode.

2.2 Function modules of the application

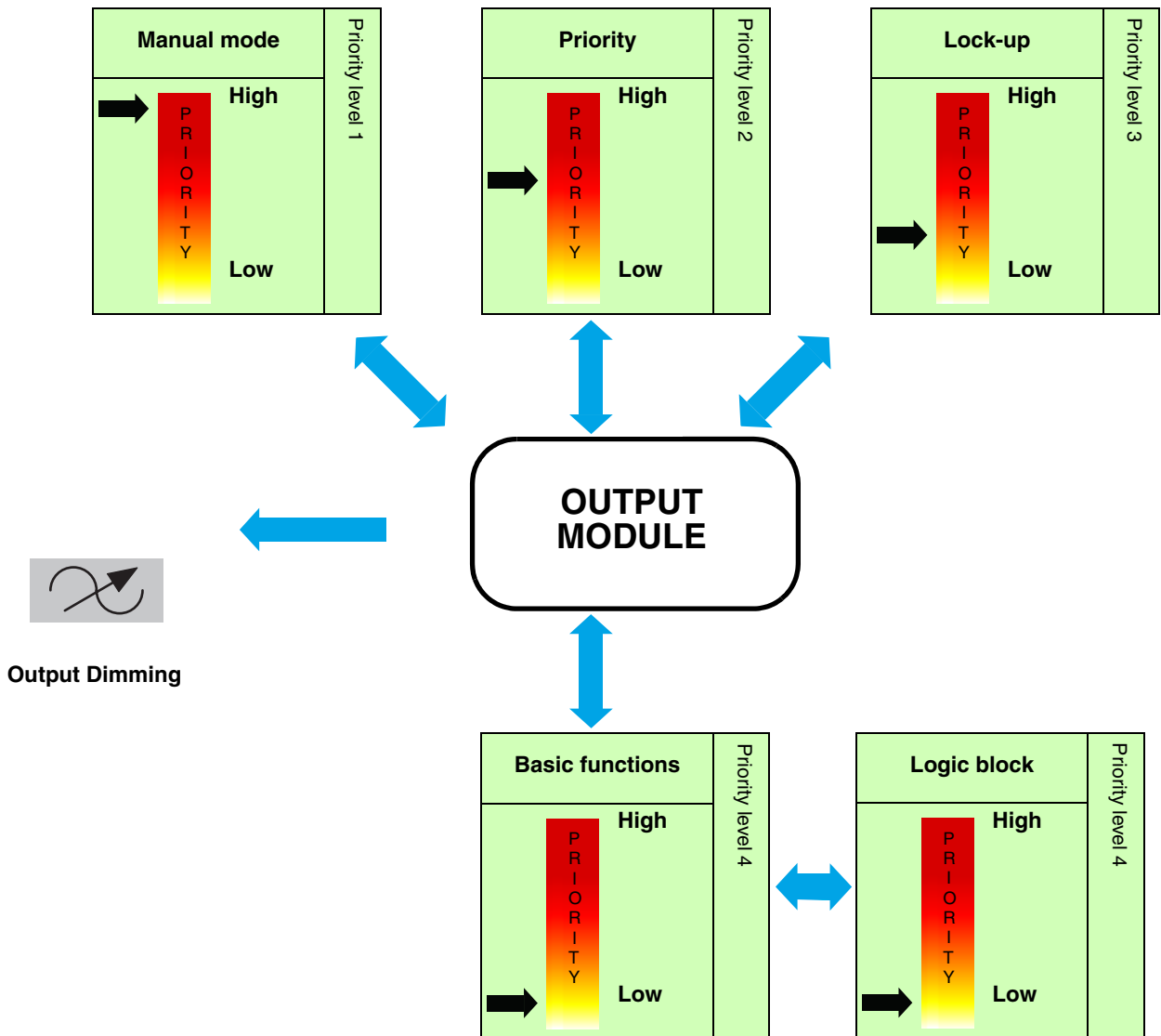

2.2.1 Primary functions

The applications allow individual configuration of the device outputs. The most important functions are:

■ ON/OFF

An output can be switched on or off using the ON/OFF function. The command can come from switches, buttons or other control inputs.

■ Relative or absolute dimming (Brightness value)

With relative dimming, the brightness value is raised or lowered with respect to the current brightness value. This is achieved, for example, by a long press on a sensor button. The dimming speed is configurable. With absolute dimming, the brightness value to be achieved is set on the dimmer as a % value.

■ Timer

The Timer function can switch a lighting circuit on or off for a configurable period. The output can be switched to a desired brightness level for a specified period. The timer may be interrupted before expiry of the delay time. A programmable Cut-OFF pre-warning announces the end of the delay time by halving the present brightness value of the output.

■ Time limited toggle switch

The Time-limited OFF function is a switching function that automatically switches off after a configurable delay time.
Application: Lighting of store rooms, cellars, sheds etc.

■ Priority

The Priority function is used to force the output into a defined state. The Priority function is controlled with a 2-bit command.
Priority: Manual mode > **Priority** > Lock-up > Basic function.
Only a Priority OFF command authorizes the output for control.
Application: Keeping lighting on for security reasons.

■ Lock-up

The Lock-up function is used to lock the output in a predefined state.
Priority: Manual mode > Priority > **Lock-up** > Basic function.
The Lock-up prevents actuation until an unlock command has been received. The Lock-up duration can be set.

■ Scene

The Scene function is used to switch groups of outputs into a configurable predefined state. A scene is activated by receipt of a 1-byte command. Each output can be included in 64 different scenes.

■ Preset

The Preset function is used to switch an output into various predefined states. The Preset function is activated via an object in 1-bit format. Each output can be controlled via 2 Preset objects.

■ Delay

The Delay functions are used to activate the outputs with a switching or tripping delay or with a switching and tripping delay.

■ Timer/toggle switch changeover

The Timer/toggle switch changeover function is used to switch between a Timer and a Toggle switch function applied to the communication object ON/OFF.

■ Hours counter

The Hours Counter function is used to count the overall operating time of an output in the ON or OFF state. The counter setpoint can be programmed and altered via an object.

■ Setting of the minimum and maximum brightness value

This function is used to set the minimum and maximum values for relative dimming for each output. These limits can be set using ETS parameter setting or locally on the front of the device.

■ Number of used outputs selection (Reference TYA663A only)

1, 2 or 3 lighting circuits can be controlled using this device. The maximum available power per output depends on the number of outputs used. The total power output is limited to 900W:

- 1 output uses: 900W
- 2 outputs use: C1 = 600W and C2 = 300W
- 3 outputs use: C1-C3 with 300W per output

2.2.2 Additional functions

The applications configure the general functions of the devices. The following functions apply to the entire device:

■ Manual mode

Manual mode allows the device to be disconnected from the bus. In this mode, each output can be priority controlled locally. This command has the highest priority. No other command is considered when manual mode is active. Only after ending manual mode are other types of control again permitted. The duration of the manual control can be configured. Manual mode can be locked-up via the KNX bus.

■ Status indication

The behaviour of the status indication of each switching channel can be configured for the entire device. The Status indication sends the switching status of the individual output contact on the KNX bus.

■ Logic block

The Logic function is used to control an output depending on the result of a logic operation. This command has the lowest priority. The result of the function can be output on the KNX bus and can directly control one or more outputs. There are 2 logic blocks per device with up to 4 inputs available.

■ Diagnosis

The Device diagnosis function allows notifications about the operating state of the device to be sent via the KNX bus. This information is sent periodically and/or on status change.

■ Selecting expert mode or dimming mode

The dimming mode for each dimming output can be specified as Expert mode using the controls on the front of the device or via the ETS dimming mode parameter.

3. Parameters

The function of the different devices only differs in the number of outputs. For this reason, only one device or one output will ever be described.

3.1 Definition of the general parameters

This configuration window is used for general configuration of the device.

Device: 1.1.4 3-fold dimming actuator 300W, universal

Outputs 1-3: Function selection

- O1-3: Manual mode
- O1-3: Status indications
- Output 1: Function selection
- Output 2: Function selection
- Output 3: Function selection
- Information

!!! The number of dimming channels has to be set on the device !!!

Manual mode	Active
Status indication	Active
Logic block 1	Not active
Logic block 2	Not active
Device diagnosis object	Not active
Activ. of restore ETS-parameters object (scenes, timer, setpoints)	Not active
Parameters overwrite at next download (scenes)	Active
Brightness value during bus power cut (0-100%), last value (101)	0
Brightness value at bus return (0-100%), last value (101)	Maintain status
Brightness value after ETS download (0-100%), last value (101)	Maintain status
Brightness val.at supply return(0-100%), last value (101)	0
Device LED switch off object	Not active

3.1.1 Manual mode

Parameter	Description	Value
Manual mode	Switching to manual mode is not possible. Switching to manual mode is possible without time limit. Manual mode can be activated for a duration that is configurable via the ETS parameters. After expiry of the time limit, manual mode is no longer active.	Not active Active* Time limited

For configuration see section: [Manual mode](#).

* Default value

3.1.2 Activation of the Status indication

Parameter	Description	Value
Status indication	The Status indications parameter register is hidden.	Not active
	The Status indications parameter register is displayed.	Active*

For configuration see section: [Status indication](#).

3.1.3 Activation of the logic blocks

Parameter	Description	Value
Logic block 1	Communication object and parameter register Logic block 1 are hidden.	Not active*
	Communication object and parameter register Logic block 1 are displayed.	Active

For configuration see section: [Logic block](#).

Note: The parameters and objects are identical for block 2 ; Only the terms will be adjusted.

For logic block 1

Communication objects: **96 - Logic block 1 - Input 1** (1 bit - 1.002 DPT_Bool)
 100 - Logic block 1 - Logic result (1 bit - 1.002 DPT_Bool)

For logic block 2

Communication objects: **102 - Logic block 2 - Input 1** (1 bit - 1.002 DPT_Bool)
 106 - Logic block 2 - Logic result (1 bit - 1.002 DPT_Bool)

3.1.4 Activation of the Device diagnosis object

Parameter	Description	Value
Device diagnosis object	The Device diagnosis parameter register and the associated communication object is hidden.	Not active*
	The Device diagnosis parameter register and the associated communication object are displayed.	Active

Communication object: **109 - Outputs 1-3 - Diagnosis** (6 byte - Specific)

For configuration see section: [Diagnosis](#).

* Default value

3.1.5 Restore ETS-Parameters

There are 2 types of parameters in the device:

- Parameters that can only be changed via ETS.
- Parameters that can be changed via ETS or via the KNX bus.

For parameters that can be changed via ETS and via the KNX bus, 2 values are stored in the device memory: The value corresponding to the ETS-parameter and the currently used value.

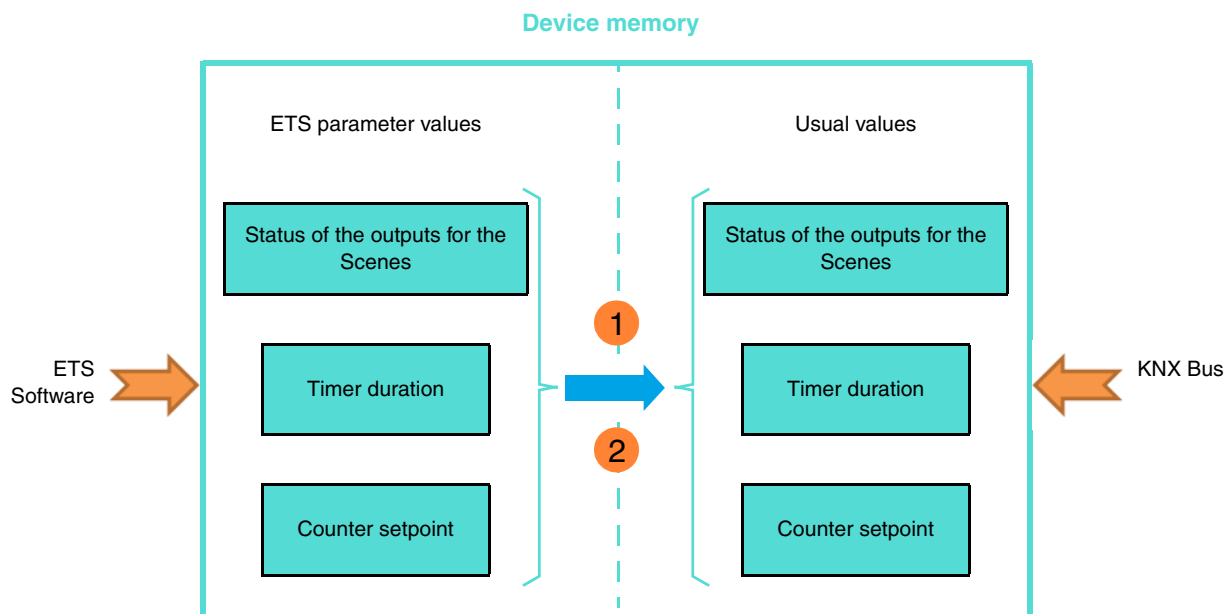

1 Receipt of the value 1 on the object, Resets the ETS parameter values: Current parameter values are replaced by the ETS-parameter values.

2 Download of the ETS application: Current parameter values are replaced by the ETS parameter values on download.

Parameter	Description	Value
Activ. of restore ETS-parameters object (scenes, timer, setpoints)	The Restore ETS-params settings communication object is hidden.	Not active*
	The Restore ETS-params settings communication object is displayed.	Active
	On receipt of a 1 on this object, the parameters** that are adjustable via the bus are overwritten with values set in the ETS before the last download.	

** Output status for scene X, Timer duration, Hours counter setpoint.

Communication object: [107 - Outputs 1-3 - Restore ETS-params settings \(1 bit - 1.015 DPT_Reset\)](#)

Parameter	Description	Value
Parameters overwrite at next download (scenes)	The parameter values stored in the device will remain in the device at the next download.	Not active
	The parameter values stored in the device will be overwritten with the ETS configured values at the next download.	Active*

* Default value

3.1.6 Status during bus power cut or download

Parameter	Description	Value
Brightness value during bus power cut (0-100%), last value (101)	On bus failure the output is set to the entered brightness value.	0* ... 100%
	The output status remains unchanged during a bus power cut.	101

Parameter	Description	Value
Brightness value at bus return (0-100%)	The output status remains unchanged during at bus return.	Maintain status*
	The output is switched on at bus return.	ON
	The output is switched off at bus return.	OFF
	The output is targeted on the stored brightness value set.	Value %

Note: The device will reboot on bus return. The Priority functions that were present before the bus power cut, are no longer active (Priority, Lock-up).

Parameter	Description	Value
Brightness value at bus return (0-100%)	This parameter defines the brightness value that is set on the output after return of the KNX bus.	0 ... 100%*

*Note: This parameter is only visible if the **Brightness value at bus return (0-100%)** return parameter has the following value: **Value %**.*

Parameter	Description	Value
Dimming speed for brightness value at bus return	This parameter defines the dimming speed for attaining the brightness value after return of the KNX bus.	0 hours: 0 to 23 h
		0 minutes: 0 to 59 min
		0 seconds: 0 to 59 s

*Note: This parameter is only visible if the **Brightness value at bus return (0-100%)** return parameter has the following value: **Value %**.*

Parameter	Description	Value
Brightness value after ETS download (0-100%)	The output status remains unchanged after ETS download.	Maintain status*
	The output is switched on after ETS download.	ON
	The output is switched off after ETS download.	OFF
	The output is targeted on the stored brightness value set.	Value %

Note: During ETS-parameters download, the outputs remain unchanged.

Parameter	Description	Value
Brightness value after ETS download (0-100%)	This parameter defines the brightness value that is set on the output after download of the ETS parameters.	0 ... 100%*

*Note: This parameter is only visible if the **Brightness value after ETS download (0-100%)** parameter has the following value: **Value %**.*

* Default value

Parameter	Description	Value
Dimming speed for brightness value after ETS download	This parameter defines the dimming speed for attaining the brightness value after download of the ETS parameters.	0 hours: 0 to 23 h 0 minutes: 0 to 59 min 0 seconds: 0 to 59 s

*Note: This parameter is only visible if the **Brightness value after ETS download (0-100%)** parameter has the following value: **Value %**.*

Parameter	Description	Value
Brightness val.at supply return (0-100%), last value (101)	After a return of power, the output is set to the stored brightness value.	0* ... 100%
	After a return of power, the output status is set to the last brightness value.	101

3.1.7 LED display

Parameter	Description	Value
Device LED switch off object	The Device LEDs lock-up communication object is hidden.	Not active*
	The Device LEDs lock-up communication object is displayed.	Active

This function is used to reduce the overall power consumption of the device. It allows the LEDs on the front of the device to be switched off.

Communication object: [108 - Outputs 1-3 - Device LED switch off \(1 bit - 1.001 DPT_Switch\)](#)

Parameter	Description	Value
Polarity	Object Device LED lock receives: 0 = The LED display is activated 1 = The LED display is deactivated 0 = The LED display is deactivated 1 = The LED display is activated	0 = Status indication, 1 = Always OFF* 0 = Always OFF, 1 = Status indication

*Note: This parameter is only visible if the parameter **Device LED switch off object** has the following value: **Active**.*

* Default value

3.2 Manual mode

In manual mode the device is disconnected from the KNX bus.

The function of the connected load can be checked using the manual mode button. Manual mode can only be activated using the switch on the front of the device. In this mode, telegrams arriving from the KNX bus are ignored.

When manual mode is activated, the status of the relays initially remains unchanged. Each time the manual mode button of an output is pressed, its status is switched over.

The behaviour is determined by the following parameters:

Device: 1.1.4 3-fold dimming actuator 300W, universal

- Outputs 1-3: Function selection
 - O1-3: Manual mode
 - O1-3: Status indications
- Output 1: Function selection
- Output 2: Function selection
- Output 3: Function selection
- Information

Object deactivation of manual mode: Active

Polarity: 0=Manual mode authorized, 1=Manual mode locked

Object status indication manual mode: Active

Polarity: 0=Manual mode deactivated, 1=Manual mode activated

Emission: On status change

Status after manual mode: Value %

Brightness value after manual mode (0-100%), last value (101): 100

Dimming speed for brightness value after manual mode (h): 1

Dimming speed for brightness value after manual mode (min): 0

Dimming speed for brightness value after manual mode (s): 0

3.2.1 Duration of manual mode activation

Parameter	Description	Value
Duration of manual mode activation	This parameter defines the amount of time for which manual mode remains activated.	0 hours: 0 to 23 h 30 minutes: 0 to 59 min 0 seconds: 0 to 59 s

Note: The smallest executable time is 1 second.

*Note: This parameter is only visible if the **Manual mode** parameter has the following value: **Time limited**.*

3.2.2 Deactivation of manual mode

Parameter	Description	Value
Object deactivation of manual mode	The Deactivation of manual mode communication object is hidden. The Deactivation of manual mode communication object is displayed.	Not active* Active

Communication object: [93 - Outputs 1-3 - Deactivation of manual mode \(1 bit - 1.001 DPT_Switch\)](#)

* Default value

Parameter	Description	Value
Polarity	The Deactivate manual mode object receives: 0 = Manual mode is activated 1 = Manual mode is not activated 0 = Manual mode is not activated 1 = Manual mode is activated	0 = Manual mode authorized, 1 = Manual mode locked-up* 0 = Manual mode locked-up, 1 = Manual mode authorized

Note: This parameter is only visible if the **Object deactivation of manual mode** parameter has the following value: **Active**.

3.2.3 Status indication manual mode

Parameter	Description	Value
Object status indication manual mode	The Status indication manual mode communication object is hidden. The Status indication manual mode communication object is displayed.	Not active* Active

Communication object: [94 - Outputs 1-3 - Status indication manual mode \(1 bit - 1.011 DPT_State\)](#)

Parameter	Description	Value
Polarity	The Status indication manual mode communication object sends: 0 = When manual mode is switched on 1 = When manual mode is switched off 0 = When manual mode is switched off 1 = When manual mode is switched on	0 = Manual mode active, 1 = Manual mode not active 0 = Manual mode not active, 1 = Manual mode active*

Note: This parameter is only visible if the **Object status indication manual mode** parameter has the following value: **Active**.

Parameter	Description	Value
Emission	The Status indication manual mode communication object is sent: On switching manual mode on or off. Periodically after a configurable time. On switching manual mode on or off and periodically after a configurable time.	On status change* Periodically On status change and periodically

Note: This parameter is only visible if the **Object status indication manual mode** parameter has the following value: **Active**.

Parameter	Description	Value
Hours (h)	This parameter determines the time between the individual transmissions of the Status indication manual mode object.	0 hours: 0 to 23 h
Minutes (min)		30 minutes: 0 to 59 min
Seconds (s)		0 seconds: 0 to 59 s

Note: This parameter is only visible if the **Emission** parameter has the following value: **Periodically** or **On status change and periodically**.

* Default value

3.2.4 Status after manual mode

Parameter	Description	Value
Status after manual mode	At the end of manual mode, the output status is: Not changed. Is switched to the opposite status. Selectively switched on. Selectively switched off. Set to the stored value. Switched back to the status before manual mode was activated. Switched to the status which would be active according to other communication objects if the manual mode had not taken place.	Maintain status* Inversion ON OFF Value % Status before manual mode Theoretical status without manual mode

Note: The application of this parameter depends on the priority of the other active functions. If a function with higher priority is active, this parameter will not be enacted. In the case where two functions with the same priority are active, the parameter of the most recently switched off function is enacted.

Note on inversion: If the brightness value is greater than or equal to 1%, the value goes to 0%. If the brightness value is less than 1%, the value goes to 100%.

Parameter	Description	Value
Brightness value after manual mode (0-100%)	This parameter defines the brightness value that is applied on the output after the end of manual mode.	0 ... 100%*

*Note: This parameter is only visible if the **Status after manual mode** parameter has the following value: **Value %**.*

Parameter	Description	Value
Dimming speed for brightness value after manual mode	This parameter defines the dimming speed for attaining the brightness value after the use of manual mode.	1 hours: 0 to 23 h 0 minutes: 0 to 59 min 0 seconds: 0 to 59 s

*Note: This parameter is only visible if the **Status after manual mode** parameter has the following value: **Value %**.*

* Default value

3.3 Status indication

The status Indication function specifies the status of the output contact.

Device: 1.1.4 3-fold dimming actuator 300W, universal

Outputs 1-3: Function selection

- O1-3: Manual mode
- O1-3: Status indications
- Output 1: Function selection
- Output 2: Function selection
- Output 3: Function selection
- Information

Status indication ON/OFF	Active
Polarity	0 = OFF, 1 = ON
Emission during manual mode	Not active
Emission	On status change
Emission after bus power return (h)	0
Emission after bus power return (min)	0
Emission after bus power return (s)	20
Status ind. brightness value	Active
Brightness value emission during manual mode	Not active
Brightness value emission	On status change
Emission brightness value after bus power return (h)	0
Emission brightness value after bus power return (min)	0
Emission brightness value after bus power return (s)	20

Parameter	Description	Value
Object status indication ON/OFF	The associated parameters are hidden.	Not active
	The associated parameters are displayed.	Active*

Parameter	Description	Value
Polarity	The Status indication ON/OFF communication object sends: 0 = For an open output contact 1 = For a closed output contact	0 = OFF, 1 = ON*
	0 = For a closed output contact 1 = For an open output contact	0 = ON, 1 = OFF

*Note: If the Blinking function is activated, the above parameter is ignored and replaced by the **Output status during Blinking function** parameter.*

Parameter	Description	Value
Emission during manual mode	The Status indication ON/OFF communication object sends: Values if the output status is switched in manual mode.	Active*
	No values if the output status is switched in manual mode.	Not active

* Default value

Parameter	Description	Value
Emission	The Status indication ON/OFF communication object is sent: On each output change. Periodically after a configurable time. On output change and periodically after a configurable time.	On status change* Periodically On status change and periodically

Parameter	Description	Value
Hours (h)	This parameter determines the time between the individual transmissions of the Status indication ON/OFF object.	0 hours: 0 to 23 h
Minutes (min)		10 minutes: 0 to 59 min
Seconds (s)		0 seconds: 0 to 59 s

Note: The smallest executable time is 1 second.

Note: This parameter is only visible if the **Emission** parameter has the following value: **Periodically** or **On status change and periodically**.

Parameter	Description	Value
Emission after bus power return	This parameter determines the delay for emission of the Status indication ON/OFF object on return of the KNX bus after a power cut.	0 hours: 0 to 23 h 0 minutes: 0 to 59 min 20 seconds: 0 to 59 s

Note: The smallest executable time is 1 second.

Note: This parameter can be used to optimize the bus load after the return of the KNX bus voltage.

Parameter	Description	Value
Status ind. brightness value	The associated parameters are hidden. The associated parameters are displayed.	Not active* Active

Parameter	Description	Value
Brightness value emission during manual mode	The Status ind. brightness value communication object sends Values if the output status is switched in manual mode. No values if the output status is switched in manual mode.	Not active* Active

Parameter	Description	Value
Brightness value emission	The Status ind. brightness value communication object is sent: On each output change. Periodically after a configurable time. On output change and periodically after a configurable time.	On status change* Periodically On status change and periodically

* Default value

Parameter	Description	Value
Periodical emission delay brightness value	This parameter determines the time between the individual transmissions of the Status ind. brightness value .	0 hours: 0 to 23 h 10 minutes: 0 to 59 min 0 seconds: 0 to 59 s

*Note: This parameter is only visible if the **Brightness value emission** parameter has the following value: **Periodically** or **On status change and periodically**.*

Parameter	Description	Value
Emission brightness value after bus power return	This parameter determines the delay for emission of the Status ind. brightness value object on return of the KNX bus after a power cut.	0 hours: 0 to 23 h 0 minutes: 0 to 59 min 20 seconds: 0 to 59 s

This parameter can be used to optimize the bus load after the return of the KNX bus voltage.

3.4 Logic block

The Logic function is used to control an output depending on the result of a logic operation. This command has the lowest priority. The result of the function can be output on the KNX bus and may directly relate to the status of one or more outputs. 2 logic blocks are available for each device.

The behaviour is determined by the following parameters:

Note: The description of the parameters is given for logic block 1. The parameters and objects are identical for logic block 2 ; Only the terms will be adjusted.

Device: 1.1.4 3-fold dimming actuator 300W, universal

<ul style="list-style-type: none"> Outputs 1-3: Function selection - O1-3: Manual mode - O1-3: Status indications <li style="border: 1px solid #ccc;">- O1-3: Logic block 1 - O1-3: Logic block 2 Output 1: Function selection Output 2: Function selection Output 3: Function selection Information 	Logic function type	OR
	Number of logic input	1
	Inverting value of logic input 1	Maintain status
	Value at initialization logic input 1	Value before initialization
	Authorization object logic block	Active
	Value at initialization	Value before initialization
	Polarity	0 = Locked-up , 1 = Authorized
	Logic result after autorisation	Immediate emission when authorization
	Emission of logic result	By logic result value change
	Logic result acts on outputs	Active
	Output 1	Yes
	Output 2	Yes
	Output 3	Yes
	Action if logic result = 0	OFF
Action if logic result = 1	ON	

Operating principle of the logic block:

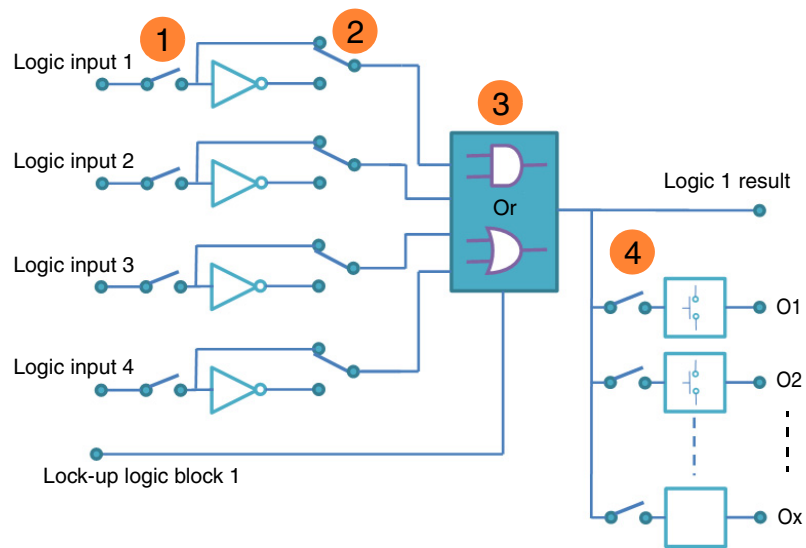

- ① Logic input number: Allows authorization of the logic input
- ② Logic input value: Inverted, yes or no
- ③ Type of logic function (AND or OR): Selection of the logic function
- ④ The logic result is applied to outputs: Selection of the outputs concerned by the logic operation

3.4.1 Configuration of the Logic function

Parameter	Description	Value
Logic function type	The input objects are: OR linked. AND linked.	Or* And

For logic table see: [Appendix](#).

Parameter	Description	Value
Number of logic inputs	This parameter determines the number of inputs of the logic block. Up to 4 inputs can be used.	1* 2 3 4

Communication objects:

- Block 1
 - 97 - Logic block 1 - Input 2 (1 bit - 1.002 DPT_Boot)
 - 98 - Logic block 1 - Input 3 (1 bit - 1.002 DPT_Boot)
 - 99 - Logic block 1 - Input 4 (1 bit - 1.002 DPT_Boot)
- Block 2
 - 103 - Logic block 2 - Input 2 (1 bit - 1.002 DPT_Boot)
 - 104 - Logic block 2 - Input 3 (1 bit - 1.002 DPT_Boot)
 - 105 - Logic block 2 - Input 4 (1 bit - 1.002 DPT_Boot)

Parameter	Description	Value
Inverting value of logic input x	The value of logic input x works on the logic block: With its object value (0=0, 1=1). With inverted object value (0=1, 1=0).	Maintain status* Status inversion

x = 1 to 4

Parameter	Description	Value
Value at initialization of logic input x	On initialization of the device after a download or after return of the bus power, the value of the logic input is: Set to 0. Set to 1. Set according to the value of the logic input before the initialization occurred.	0 1 Value before initialization*

x = 1 to 4

* Default value

3.4.2 Logic block authorization

Principle of logic block authorization:

The parameters are set as follows:

- Logic block authorization: 0 = Locked-up, 1 = Authorized.
- Action if logic result = 0 : Scene 1.
- Action if logic result = 1 : Scene 2.
- Logic input 1 and 2 are AND-linked.
- Emission of logic result: By input value change.

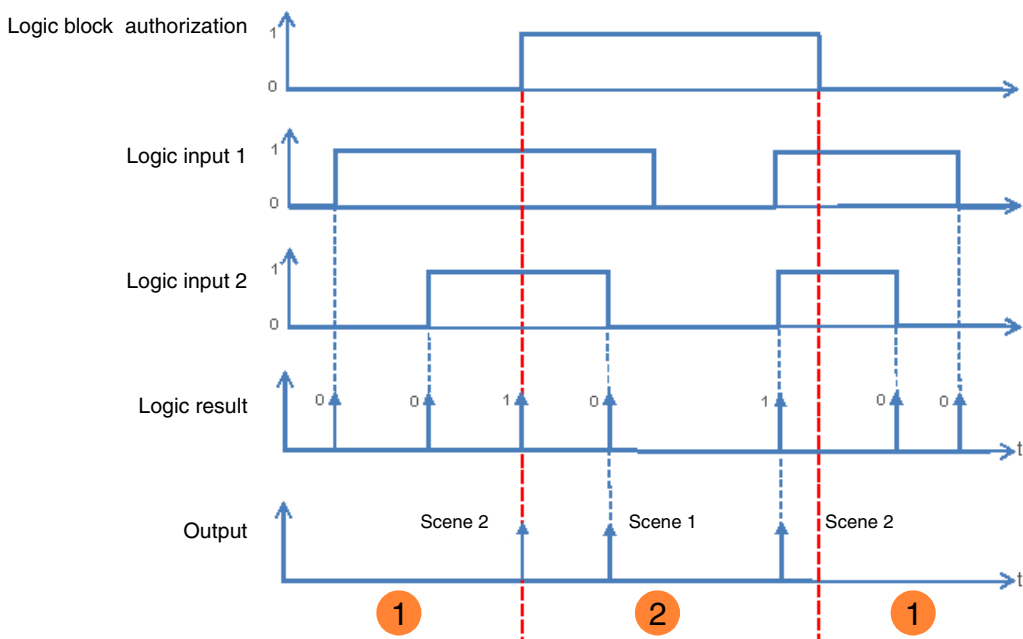

- ① The logic result has no influence on the outputCurrent values.
- ② The commands from the logic result are executed.

*Note: The commands from the logic result are executed immediately after authorization, according to the **Logic result after authorization** parameter.*

Parameter	Description	Value
Authorization object logic block	The Logic block 1 – Authorization communication object and related parameters are hidden.	Not active*
	The Logic block 1 – Authorization communication object and related parameters are displayed.	Active

Note: If the logic block is locked the logic operation is not processed.

- Communication objects:
- Block 1 **95 - Logic block 1 - Authorization (1 bit - 1.003 DPT_Enable)**
 - Block 2 **101 - Logic block 2 - Authorization (1 bit - 1.003 DPT_Enable)**

* Default value

Parameter	Description	Value
Value at initialization	On initialization of the device after a download or after return of the bus power, the value of the Logic block 1 – Authorization object is: Set to 0. Set to 1. Set according to the value that the object had before initialization.	0 1 Value before initialization*

*Note: This parameter is only visible if the **Authorization object logic block** parameter has the following value: **Active**.*

Parameter	Description	Value
Polarity	On receipt of a value on the Logic block 1 – Authorization object, this is: Locked-up on object value 1. Locked-up on object value 0.	0 = Authorized, 1 = Locked-up 0 = Locked-up, 1 = Authorized*

*Note: This parameter is only visible if the **Authorization object logic block** parameter has the following value: **Active**.*

Parameter	Description	Value
Logic result after autorisation	On authorization of the logic block: The value of the Logic result is immediately determined. The value of the logic result is first determined after receipt of a value on a logic input.	Immediate emission when authorization* No immediate emission

*Note: This parameter is only visible if the **Authorization object logic block** parameter has the following value: **Active**.*

* Default value

3.4.3 Logic result

Parameter	Description	Value
Emission of logic result	The Logic result object will be sent on: Each receipt of a telegram on one of the logic inputs. A change in the value of the logic result.	By input value change By logic result value change*

Parameter	Description	Value
Logic result acts on outputs	The logic results acts: Only on the Logic result communication object. On the Logic result communication object and directly on one or more outputs.	Not active* Active

The status of the affected outputs is determined by the parameter **action on logic result = x**.

Parameter	Description	Value
Output 1 ... x	The output relationship with the Logic result is: Directly dependent. Independent.	Yes* No

*Note: This parameter is only visible if the **Logic result acts on outputs** parameter has the following value: **Active**.*

Parameter	Description	Value
Action if logic result = 0	On the outputs that are directly dependent on Logic result, if the output value = 0, the status: Not changed. Is switched to the opposite status. Selectively switched on. Selectively switched off. Set to the stored value. Starts timer mode. Stops timer mode. Starts one of the 64 scenes. Adopts the default value given by the parameter Status if preset 1 object = 0 . Adopts the default value given by the parameter Status if preset 2 object = 0 .	Maintain status Inversion ON OFF* Value % Timer start Timer stop Scene number Preset 1 Preset 2

Note on inversion: If the brightness value is greater than or equal to 1%, the value goes to 0%. If the brightness value is less than 1%, the value goes to 100%.

Note: The Timer mode, Scene function or Preset function of the selected output must be configured. If this is not the case, the status remains unchanged.

* Default value

Parameter	Description	Value
Brightness val.logic result=0 (0-100%)	This parameter determines the brightness value that is applied if the logic result is 0 after the re-evaluation.	0 ... 100%*

Note: This parameter is only visible if the **Action if logic result = 0** parameter has the following value: **Value %**.

Parameter	Description	Value
Dimming speed for brightness value during logic result = 0	This parameter determines the dimming speed to attain the brightness value if the logic result is 0 after re-evaluation.	0 hours: 0 to 23 h 0 minutes: 0 to 59 min 0 seconds: 0 to 59 s

Note: This parameter is only visible if the **Action if logic result = 0** parameter has the following value: **Value %**.

Parameter	Description	Value
Scene if logic result = 0	This parameter determines the scene number that is activated if the logic result is 0 after re-evaluation.	Scene 1 ... 64 Default value: 1

The outputs respond according to the scene numbers and associated parameters.

Note: This parameter is only visible if the **Action if logic result = 0** parameter has the following value: **Scene number**.

Parameter	Description	Value
Action if logic result = 1	On the outputs that are directly dependent on Logic result, if the output value = 1, the status: Not changed. Is switched to the opposite status. Selectively switched on. Selectively switched off. Set to the stored value. Starts timer mode. Stops timer mode. Starts one of the 64 scenes. Adopts the default value given by the parameter Status if preset 1 object = 0 . Adopts the default value given by the parameter Status if preset 2 object = 0 .	Maintain status Inversion ON* OFF Value % Timer start Timer stop Scene number Preset 1 Preset 2

Note on inversion: If the brightness value is greater than or equal to 1%, the value goes to 0%. If the brightness value is less than 1%, the value goes to 100%.

Note: The Timer mode, Scene function or Preset function of the selected output must be configured. If this is not the case, the status remains unchanged.

* Default value

Parameter	Description	Value
Brightness val.logic result=1 (0-100%)	This parameter determines the brightness value that is applied if the logic result is 1 after the re-evaluation.	0 ... 100%*

*Note: This parameter is only visible if the **Action if logic result = 1** parameter has the following value: **Value %**.*

Parameter	Description	Value
Dimming speed for brightness value during logic result = 1	This parameter determines the dimming speed to attain the brightness value if the logic result is 0 after re-evaluation.	0 hours: 0 to 23 h 0 minutes: 0 to 59 min 0 seconds: 0 to 59 s

*Note: This parameter is only visible if the **Action if logic result = 1** parameter has the following value: **Value %**.*

Parameter	Description	Value
Scene if logic result = 1	This parameter determines the scene number that is activated if the logic result is 1 after re-evaluation.	Scene 1 ... 64 Default value: 2

The outputs respond according to the scene numbers and associated parameters.

*Note: This parameter is only visible if the **Action if logic result = 1** parameter has the following value: **Scene number**.*

* Default value

3.5 Diagnosis

The **Device diagnosis** object allows notifications about the operating status of the device to be sent via the KNX bus. This information is sent periodically and/or on status change.

The **Device diagnosis** object allows reporting of current faults according to the device and application. It also allows sending of the position of the switch on the front of the device and the number of the output that is affected by the fault(s).

The **Device Diagnosis** object is a 6-byte object that is composed as described below:

Byte number	6 (MSB)	5	4	3	2	1 (LSB)
Use	Switch position	Application type	Output number	Error codes		

Details of the byte:

- **Bytes 1 to 4:** Correspond to the error codes.

b31	b30	b29	b28	b27	b26	b25	b24	b23	b22	b21	b20	b19	b18	b17	b16	b15	b14	b13	b12	b11	b10	b9	b8	b7	b6	b5	b4	b3	b2	b1	b0
X	X	X	X	28	27	26	X	X	X	22	21	20	19	18	17	X	X	X	X	X	11	X	9	X	X	X	X	X	X	X	X

N°	Faults
26	Interruption to the power supply: The supply voltage of 230V is not available. The device continues to run thanks to the supply on the KNX bus.
27	Wrong context: The user's parameters are not transferable. The standard parameters are restored.
28	TP communication out of operation: Communication via the KNX bus was not available on the previous start.
17	Overload at the output: The output current flowing through the output contact is too high.
18	Short circuit on the output: The dimmer automatically reduces the available power and no longer controls the load.
19	Over temperature on the output: The available power is reduced as long as the overtemperature is present.
20	Load default on output: The load on the corresponding output is non-existent or defective.
21	Malfunction of the device switch: The position of the AUTO/MIN/MAX/MANU switch can not be determined (e.g. because of a fault with the internal contact).
22	Fault with the output number selection switch: (Concerns product reference TYA663A only) The position of the channel number selection switch can not be determined (e.g. because of a fault with the internal contact) (e.g. because of a fault with the internal contact).
9	Excessive number of restarts: This bit is use for notification of repeated restarts and/or a restart triggered by a Watch-Dog. Such a restart is not necessarily apparent to the user from the function, rather it is manifest as a disturbed environment or a bad contact of the power supply.
11	Over voltage at the output: The dimmer automatically reduces the available power and no longer controls the load.

Note: The use of the standard bit depends on the type of device used (switch actuator, dimmer, shutter/blind, etc.). Certain bit are same for all devices and others are application-specific.

- **Byte 5:** Corresponds to the application type and the number of the output affected by the error.

MSB				LSB			
b7	b6	b5	b4	b3	b2	b1	b0
Application type				Output number			
0 = Not defined				0 = Device error			
1 = Switch actuator				1 = Output 1			
2 = Shutter/blind				2 = Output 2			
3 = Dimmer						
				Y = Output Y			

Note: Y is the placeholder for the maximum number of outputs.

- **Byte 6:** Switch position.

MSB							LSB
b7	b6	b5	b4	b3	b2	b1	b0
X	X	X	X	X	X	X	1

1: 0 = Automatic mode / 1 = Manual mode

Note: Bit marked with an x are not used.

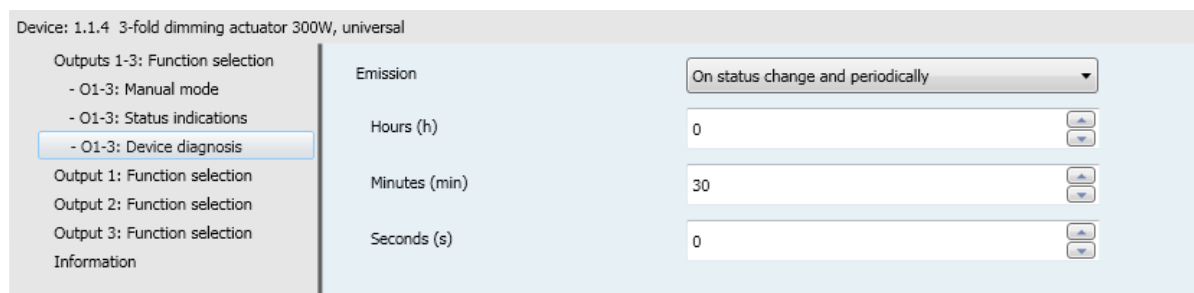

Parameter	Description	Value
Emission	The Device diagnosis communication object is sent to bus: On each change. Periodically after a configurable time. On change and periodically after a configurable time.	On status change* Periodically On status change and periodically

Parameter	Description	Value
Hours (h)	This parameter determines the time between the individual transmissions of the Device diagnosis object.	0 hours: 0 to 23 h
Minutes (min)		30 minutes: 0 to 59 min
Seconds (s)		0 seconds: 0 to 59 s

Note: The smallest executable time is 1 second.

Note: This parameter is only visible if the **Emission** parameter has the following value: **Periodically** or **On status change and periodically**.

* Default value

3.6 Function selection

This parameter window is used to set the device outputs. These parameters are available individually for each output.

Device: 1.1.4 3-fold dimming actuator 300W, universal

Outputs 1-3: Function selection

- O1-3: Manual mode
- O1-3: Status indications
- Output 1: Function selection
- Output 2: Function selection
- Output 3: Function selection
- Information

Local min/max relative dimming limit settings		Not active
Apply relative min/max values after download		Active
Dimming mode after download		Values set on product
Authorization of the expert button		Active
Load memorisation		Not active
Relative diming speed (h)	0	<input type="button" value="↑"/> <input type="button" value="↓"/>
Relative dimming speed (min)	0	<input type="button" value="↑"/> <input type="button" value="↓"/>
Relative dimming speed (s)	4	<input type="button" value="↑"/> <input type="button" value="↓"/>
Switch ON speed (soft ON) (h)	0	<input type="button" value="↑"/> <input type="button" value="↓"/>
Switch ON speed (soft ON) (min)	0	<input type="button" value="↑"/> <input type="button" value="↓"/>
Switch ON speed (soft ON) (s)	4	<input type="button" value="↑"/> <input type="button" value="↓"/>
Switch OFF speed (soft OFF) (h)	0	<input type="button" value="↑"/> <input type="button" value="↓"/>
Switch OFF speed (soft OFF) (min)	0	<input type="button" value="↑"/> <input type="button" value="↓"/>
Switch OFF speed (soft OFF) (s)	2	<input type="button" value="↑"/> <input type="button" value="↓"/>
Brightness value at switch ON (0-100%), last value (101)	101	<input type="button" value="↑"/> <input type="button" value="↓"/>
Minimum relative dimming value (1 - 50%)	1	<input type="button" value="↑"/> <input type="button" value="↓"/>
Maximum relative dimming value (51-100%)	100	<input type="button" value="↑"/> <input type="button" value="↓"/>
Switching ON by long press		Active
Switching OFF by long press		Active
Manual mode active for output 1		Yes
Status indication		Yes
Status indication ON/OFF		Active
Status ind. brightness value		Active
ON/OFF timings function		Not active
Timer		Not active
Scene		Not active
Preset		Not active
Lock-up		Not active
Priority		Not active
Hours counter		Not active
Notifications		Not active

3.6.1 Definition

Dimmer and switch principle:

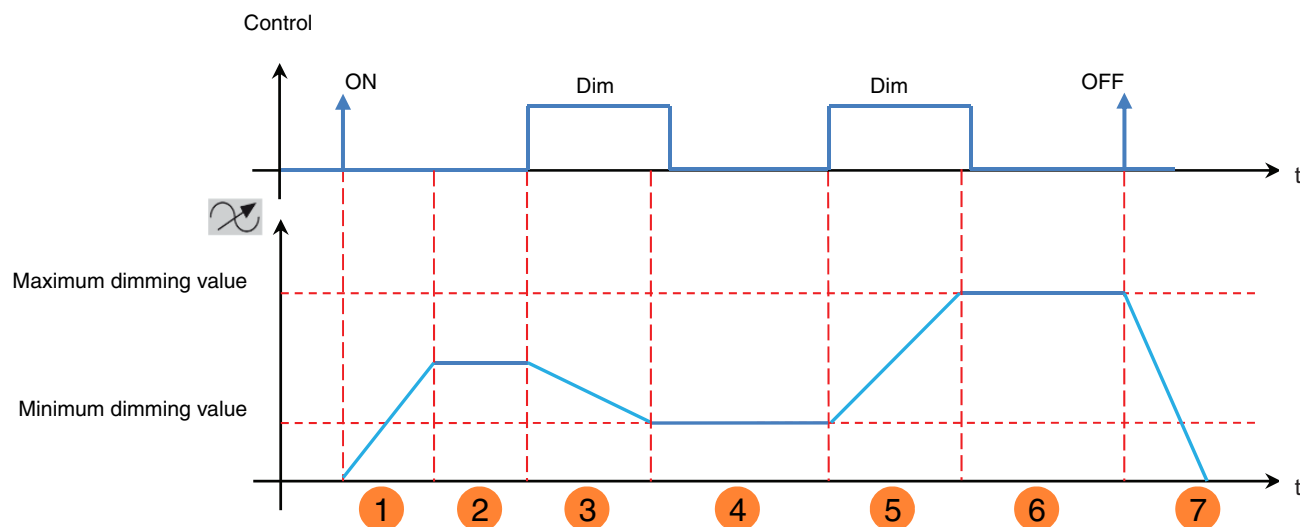

- ① Switch ON speed (soft ON)
- ② Brightness value at switch ON (0-100%), last value (101)
- ③ Relative dimming speed
- ④ Minimum relative dimming value (1 - 50%)
- ⑤ Relative dimming speed
- ⑥ Maximum relative dimming value (51-100%)
- ⑦ Switch OFF speed (soft OFF)

Upper and lower values can be set for the relative dimming for each output of the device. This configuring can be carried out over the KNX bus or locally using the buttons on the front of the device. The following parameters are used to configure the device for local settings.

Parameter	Description	Value
Local min/max relative dimming limit settings	The setting of a min/max value for relative dimming using the controls on the front of the device Is not possible. Is possible.	Not active* Active

Parameter	Description	Value
Apply relative min/max values after download	After an ETS download the local min/max dimming value settings are Maintained. Replaced by the ETS configured values.	Not active Active*

Note: To manually save the minimum values for the relative dimming, the input range must be between 1% and 50%. To manually save the maximum values for the relative dimming, the input range must be between 51% and 100%.

On restarting after a download or using the ETS configuration tool, the limits for relative dimming are restored according to the value of the following parameter:

* Default value

Parameter	Description	Value
Dimming mode after download	<p>The dimming mode (inductive, capacitive, LED, etc.) after an ETS download, involves.</p> <p>The dimming mode configured using the controls on the front of the device.</p> <p>The dimming mode set using the ETS configuration.</p>	<p>Values set on product*</p> <p>Values settings in ETS</p>

The dimmers have a load memorisation function in order to control dimmable fluocompact lamps and LED lamps more effectively. It is also possible to set the dimming mode intended for the connected load type.

The learning procedure can be initiated in various ways:

- Receipt of a 1 on the **Load memorisation** communication object enables the start of the learning proces.
- Load memorisation can also be started by a specific operating sequence of a KNX button.
 - Give KNX short presses on the 5 button configured for dimming (5 x ON, 5 x OFF or 5 x ON/OFF) and then one long press, until the load switches itself off.
 - Give a short press of the button to start the memorisation (Give a brief press on the push button to launch memorisation (two presses to return to factory dimming mode)).

This process lasts around 30 seconds and results in varying brightness.

After the memorisation, the load is activated on the highest step and blinks once, to report that the learning is completed.

The minimum brightness can depend on the connected load.

This learning process can be authorized or disabled using the **Load memorisation** parameter.

This learning process can also be started using the controls on the front of the device; See product user manual.

If a normal load is connected again, the device can be reset to the factory settings as follows:

After the 5 button press sequence (see section on learning the load) give two further short presses. The device acknowledges the restoration of the factory settings by blinking the load twice.

If there are no further presses of the buttons in the 10 seconds after the button pressing sequence, the device returns to the previous dimming mode.

This mode is ideal for conventional loads.

It is also possible to set the dimming mode intended for the connected load type via the ETS.

* Default value

Parameter	Description	Value
Dimming mode selection	<p>After the next ETS download, the dimming mode of the device is set as follows:</p> <p>Automatic load recognition of inductive and capacitive loads.</p> <p>Optimized dimming behaviour for energy saving lamps.</p> <p>Optimized dimming behaviour for LEDs.</p> <p>Phase control for inductive loads.</p> <p>Phase control for capacitive loads.</p> <p>When the load is first switched ON after the ETS download, the learning procedure for LEDs and energy saving lamps is started.</p>	<p>Factory setting*</p> <p>CFL</p> <p>LED</p> <p>Inductive†load</p> <p>Capacitive load</p> <p>Load memorisation</p>

Note: This parameter is only visible if the **Dimming mode after download** parameter has the following value: **Values settings in ETS**.

Parameter	Description	Value
Authorization of the expert button	<p>Setting of the dimming mode using the expert button on the front of the device is</p> <p>Is not possible.</p> <p>Is possible.</p>	<p>Not active</p> <p>Active*</p>

Parameter	Description	Value
Load memorisation	<p>The learning of the load via KNX commands is</p> <p>Is not possible.</p> <p>Is possible.</p>	<p>Not active</p> <p>Active*</p>

Parameter	Description	Value
Relative dimming speed	This parameter determines the dimming speed for the brightness steps from 0% to 100% (Long press of the dimmer switch).	<p>0 hours: 0 to 23 h</p> <p>0 minutes: 0 to 59 min</p> <p>4 seconds: 0 to 59 s</p>

Parameter	Description	Value
Switch ON speed (soft ON)	This parameter defines the switch ON speed for attaining the brightness value after input of an ON command.	<p>0 hours: 0 to 23 h</p> <p>0 minutes: 0 to 59 min</p> <p>4 seconds: 0 to 59 s</p>

Parameter	Description	Value
Switch OFF speed (soft OFF)	This parameter defines the switch OFF speed for attaining brightness value 0% after input of an OFF command.	<p>0 hours: 0 to 23 h</p> <p>0 minutes: 0 to 59 min</p> <p>2 seconds: 0 to 59 s</p>

* Default value

Parameter	Description	Value
Brightness value at switch ON (0-100%), last value (101)	On receipt of an ON command on the ON/OFF communication object, the output is set to the following value To the stored brightness value. To the last brightness value.	0 ... 100% 101*

Parameter	Description	Value
Minimum relative dimming value (1 - 50%)	This parameter specifies a minimum brightness value for the dimming.	1* ... 50

Parameter	Description	Value
Maximum relative dimming value (51-100%)	This parameter specifies a maximum brightness value for the dimming.	51 ... 100*

Parameter	Description	Value
Switching ON by long press	Switching ON the output by relative dimming (long button press or 4-bit command) Is not possible. Is possible.	Not active Active*

Parameter	Description	Value
Switching OFF by long press	Switching OFF the output by relative dimming (long button press or 4-bit command) Is not possible. Is possible.	Not active Active*

Parameter	Description	Value
Manual mode active for output 1	This output can be controlled in manual mode. This output is excluded from manual mode.	Yes* No

Parameter	Description	Value
Status indication	The Status indication communication objects and the associated parameters are hidden. The Status indication communication objects and the associated parameters are displayed.	No Yes*

* Default value

Parameter	Description	Value
Status indication ON/OFF	The Status indication ON/OFF communication object is: Hidden. Displayed, the status indication can be transmitted over the bus.	Not active Active*

Communication objects: [7 - Output 1 - Status indication ON/OFF](#) (1 bit - 1.001 DPT_Switch)
 [38 - Output 2 - Status indication ON/OFF](#) (1 bit - 1.001 DPT_Switch)
 [69 - Output 3 - Status indication ON/OFF](#) (1 bit - 1.001 DPT_Switch)

*Note: The transmission conditions for the Status indication objects must be set in the parameter Register **O1-Ox: Status indication**.*

Parameter	Description	Value
Status ind. brightness value	The Status ind. brightness value communication object is: Hidden. Displayed, the status indication can be transmitted over the bus.	Not active Active*

Communication objects: [7 - Output 1 - Status ind. brightness value](#) (1 bit - 1.001 DPT_Scaling)
 [38 - Output 2 - Status ind. brightness value](#) (1 bit - 1.001 DPT_Scaling)
 [69 - Output 3 - Status ind. brightness value](#) (1 bit - 1.001 DPT_Scaling)

*Note: The transmission conditions for the Status indication objects must be set in the parameter Register **O1-Ox: Status indication**.*

Parameter	Description	Value
ON/OFF timings function	The ON/OFF timings function tab and the associated parameters and objects are: Hidden. Displayed.	Not active* Active

For configuration see section: [ON/OFF timings function](#).

Parameter	Description	Value
Timer	The Timer tab and the associated parameters and objects are: Hidden. Displayed.	Not active* Active

Communication objects: [9 - Output 1 - Timer](#) (1 bit - 1.001 DPT_Switch)
 [40 - Output 2 - Timer](#) (1 bit - 1.001 DPT_Switch)
 [71 - Output 3 - Timer](#) (1 bit - 1.001 DPT_Switch)

For configuration see section: [Timer](#).

* Default value

Parameter	Description	Value
Scene	The Scenes tab and the associated parameters and objects are: Hidden. Displayed.	Not active* Active

Communication objects: **11 - Output 1 - Scene** (1 byte - 17.001 DPT_SceneNumber)
 42 - Output 2 - Scene (1 byte - 17.001 DPT_SceneNumber)
 73 - Output 3 - Scene (1 byte - 17.001 DPT_SceneNumber)

For configuration see section: [Scene](#).

Parameter	Description	Value
Preset	The Preset tab and the associated parameters and objects are: Hidden. Displayed for 1 Preset object. Displayed for 2 Preset objects.	Not active* Active with preset 1-level object Active with preset 2-level objects

Note: When the value of this parameter changes, the associated parameters and group addresses are deleted.

Preset 1 communication **7 - Output 1 - Preset 1** (1 bit - 1.022 DPT_Scene_AB)
 Objets **43 - Output 2 - Preset 1** (1 bit - 1.022 DPT_Scene_AB)
 74 - Output 3 - Preset 1 (1 bit - 1.022 DPT_Scene_AB)

Preset 2 communication **8 - Output 1 - Preset 2** (1 bit - 1.022 DPT_Scene_AB)
 Objets **44 - Output 2 - Preset 2** (1 bit - 1.022 DPT_Scene_AB)
 75 - Output 3 - Preset 2 (1 bit - 1.022 DPT_Scene_AB)

For configuration see section: [Preset](#).

Parameter	Description	Value
Lock-up	The Lock-up tab and the associated parameters and objects are: Hidden. Displayed for 1 lock-up object. Displayed for 2 lock-up objects.	Not active* 1 lock-up object 2 lock-up objects

* Default value

Lock-up 1 communication objects

- [16 - Output 1 - Lock-up 1](#) (1 bit - 1.003 DPT_Enable)
- [47 - Output 2 - Lock-up 1](#) (1 bit - 1.003 DPT_Enable)
- [78 - Output 3 - Lock-up 1](#) (1 bit - 1.003 DPT_Enable)

Lock-up 2 communication objects

- [17 - Output 1 - Lock-up 2](#) (1 bit - 1.003 DPT_Enable)
- [48 - Output 2 - Lock-up 2](#) (1 bit - 1.003 DPT_Enable)
- [79 - Output 3 - Lock-up 2](#) (1 bit - 1.003 DPT_Enable)

For configuration see section: [Lock-up](#).

Parameter	Description	Value
Priority	The Priority tab and the associated parameters and objects are: Hidden. Displayed.	Not active* Active

The device responds to telegrams received via the **Priority** object, as given in the following table:

Telegram received by the priority operation object		Status of the outputs
Bit 1	Bit 2	
0	0	End of the priority
0	1	End of the priority
1	0	Priority OFF
1	1	Priority ON

Communication objects:

- [19 - Output 1 - Priority](#) (2 bit - 2.002 DPT_Bool_Control)
- [50 - Output 2 - Priority](#) (2 bit - 2.002 DPT_Bool_Control)
- [81 - Output 3 - Priority](#) (2 bit - 2.002 DPT_Bool_Control)

For configuration see section: [Priority](#).

Parameter	Description	Value
Hours counter	The Hours counter tab and the associated parameters and objects are: Hidden. Displayed.	Not active* Active

A telegram can be transmitted via the **Hours counter setpoint reached** object, in accordance with a programmable setpoint.

It is also possible to reset the count value via a 1 signal on the **Reset hours counter value** object.

* Default value

Communication objects:

21 - Output 1 - Hours counter value (2 byte - 7.001 DPT_16_bit_Counter)

52 - Output 2 - Hours counter value (2 byte - 7.001 DPT_16_bit_Counter)

83 - Output 3 - Hours counter value (2 byte - 7.001 DPT_16_bit_Counter)

22 - Output 1 - Reset hours counter value (1 bit - 1.015 DPT_Reset)

53 - Output 2 - Reset hours counter value (1 bit - 1.015 DPT_Reset)

84 - Output 3 - Reset hours counter value (1 bit - 1.015 DPT_Reset)

23 - Output 1 - Hours counter setpoint reached (1 bit - 1.002 DPT_Bool)

54 - Output 2 - Hours counter setpoint reached (1 bit - 1.002 DPT_Bool)

85 - Output 3 - Hours counter setpoint reached (1 bit - 1.002 DPT_Bool)

For configuration see section: [Hours counter](#).

Parameter	Description	Value
Notifications	The Notification tab and the associated parameters and objects are: Hidden. Displayed.	Not active* Active

For configuration see section: [Notifications](#).

* Default value

3.6.2 ON/OFF timings function

Device: 1.1.4 3-fold dimming actuator 300W, universal

Outputs 1-3: Function selection

- O1-3: Manual mode
- O1-3: Status indications

Output 1: Function selection

- O1: ON/OFF object timings

Output 2: Function selection

Output 3: Function selection

Information

Delays for ON/OFF objects

Switching and tripping delay ▾

Switching delay (h) ▴ ▾

Switching delay (min) ▴ ▾

Switching delay (s), minimum value 1s ▴ ▾

Tripping delay (h) ▴ ▾

Tripping delay (min) ▴ ▾

Tripping delay (s), minimum value 1s ▴ ▾

Timer/toggle switch changeover for object ON/OFF

Active ▾

Hours (h) ▴ ▾

Minutes (min) ▴ ▾

Seconds (s), minimum value 1s ▴ ▾

Additional time limited toggle switch function

Active ▾

Hours (h) ▴ ▾

Minutes (min) ▴ ▾

Seconds (s), minimum value 1s ▴ ▾

3.6.2.1 Delays for ON/OFF objects

Parameter	Description	Value
Delays for ON/OFF objects	<p>The parameters for time-delayed switching of the outputs are:</p> <p>Hidden.</p> <p>Displayed for Switching delay.</p> <p>Displayed for Tripping delay.</p> <p>Displayed for Switching and tripping delay.</p>	<p>Not active*</p> <p>Switching delay</p> <p>Tripping delay</p> <p>Switching and tripping delay</p>

* Default value

Switching delay: Allows the configuration of a delay between the switch-on command and the switching of the output contact.

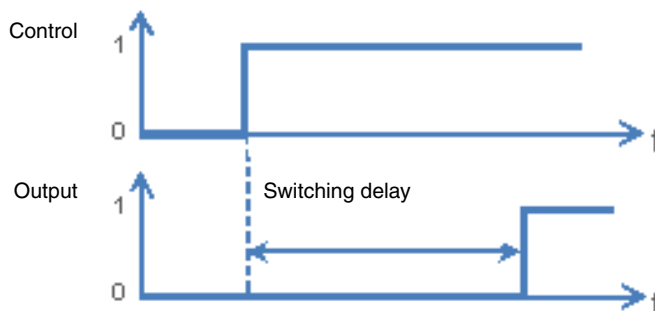

Tripping delay: Allows the configuration of a delay between the switch-off command and the switching of the output contact.

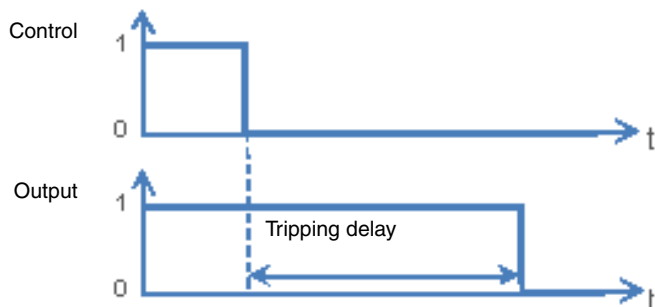

Switching and tripping delay: Allows the configuration of a delay between the switch-on command and the switching of the output contact, as well as between the switch-off command and the switching of the output contact.

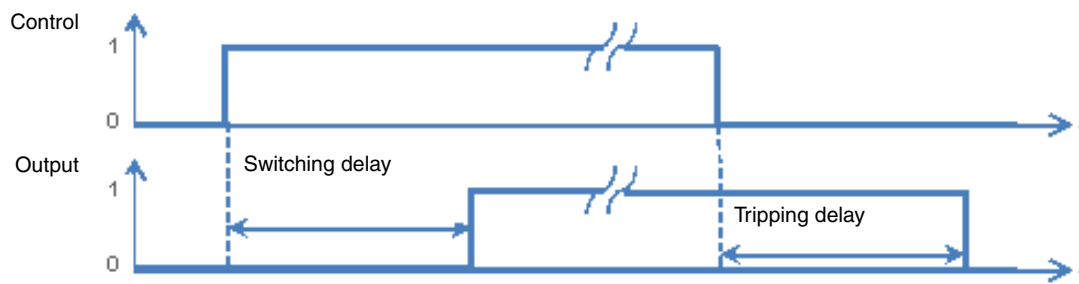

Parameter	Description	Value
Switching delay	This parameter defines the delay between the switch-on command and the switching of the output contact.	0 hours: 0 to 23 h 3 minutes: 0 to 59 min 0 seconds: 0 to 59 s

Note: The smallest executable time is 1 second.

*Note: This parameter is only visible if the **Delays for ON/OFF** objects parameter has the following value: **Switching delay** or **Switching and tripping delay**.*

Parameter	Description	Value
Tripping delay	This parameter defines the delay between the switch-off command and the switching of the output contact.	0 hours: 0 to 23 h 3 minutes: 0 to 59 min 0 seconds: 0 to 59 s

Note: The smallest executable time is 1 second.

*Note: This parameter is only visible if the **Delays for ON/OFF** objects parameter has the following value: **Tripping delay** or **Switching and tripping delay**.*

3.6.2.2 Timer/toggle switch changeover for ON/OFF object

This function switches the output channels between toggle switch and timer mode for the **ON/OFF** object.

Example: Switching function daytime and Time-limited OFF function at night.

During the day, the button is used as a switch. In the evenings, the button is used as a time-limited OFF switch, so that the light will turn off automatically.

Parameter	Description	Value
ON/OFF	The parameters for a switch-over between toggle switch and timer modes for the ON/OFF object are: Hidden. Displayed.	Not active* Active

- If the **Timer/toggle switch changeover** object receives the value 1, the Toggle-switch mode function is activated. The ON/OFF switching of the output is performed as usual via the **ON/OFF** object.
- If the **Timer/toggle switch changeover** object receives the value 0, the Timer mode function is activated.
 - If the **ON/OFF** object receives the value 1, the output is switched ON. After expiry of a configurable time, the output is automatically switched OFF.
 - If the **ON/OFF** object receives the value 0, the output is switched OFF.

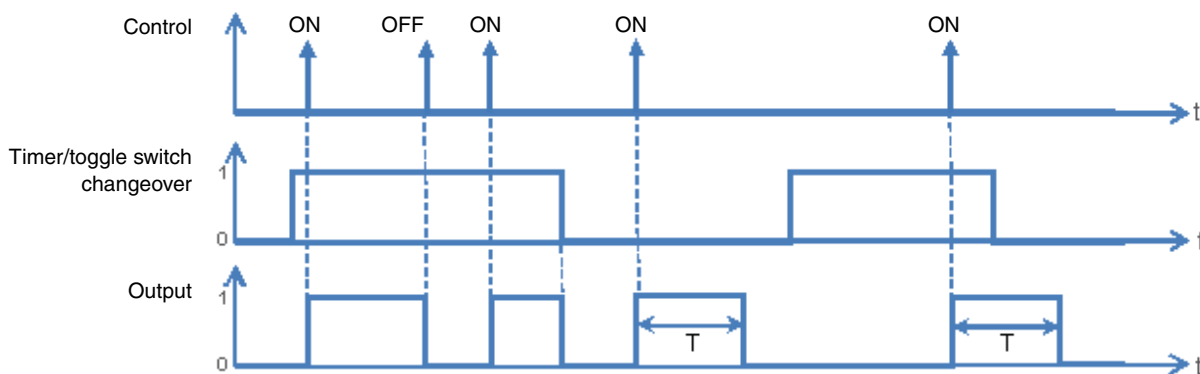

- Communication objects:
- [5 - Output 1 - Timer/toggle switch changeover \(1 bit - 1.001 DPT_Switch\)](#)
 - [36 - Output 2 - Timer/toggle switch changeover \(1 bit - 1.001 DPT_Switch\)](#)
 - [67 - Output 3 - Timer/toggle switch changeover \(1 bit - 1.001 DPT_Switch\)](#)

Parameter	Description	Value
Hours (h)	This parameter sets the length of the timer operation, if this is activated.	1 hours: 0 to 23 h
Minutes (min)		0 minutes: 0 to 59 min
Seconds (s)		0 seconds: 0 to 59 s

Note: The smallest executable time is 1 second.

*Note: This parameter is only visible if the **Timer/toggle switch changeover** parameter for the **ON/OFF** object has the following value: **Active**.*

* Default value

3.6.2.3 Time limited toggle switch

The Time-limited OFF function enables automatic switch off after a programmable Time-limited OFF time. The output works as a normal switch actuator but is switched off after a given time for security.

Example: Attic, the lighting can be switched normally but switches off after not more than 3 hours.

Parameter	Description	Value
Additional time limited toggle switch function	The parameters for setting the Time-limited OFF time are: Hidden. Displayed.	Not active* Active

Function diagram

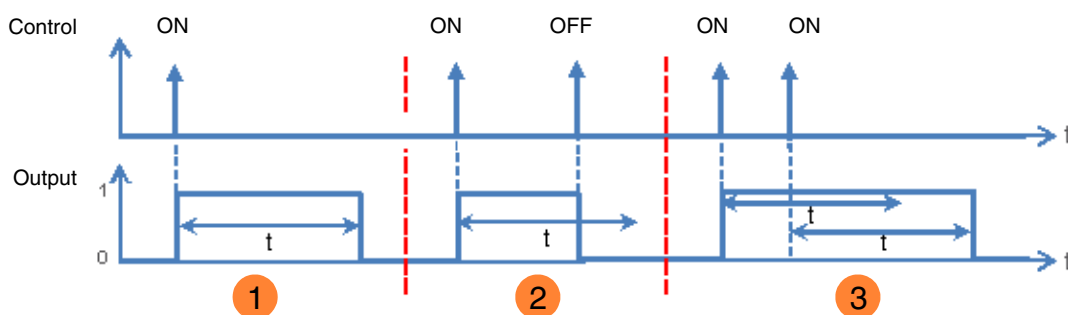

- 1** Emission of an ON command: The output which is at ON will switch to OFF on expiry of the Time-limited OFF time.
- 2** Emission of an ON command: The output switches to ON.
Emission of an OFF command before expiry of the Time-limited OFF time, t: The output switches to OFF.
- 3** Emission of an ON command: The output switches to ON.
Emission of an ON command before expiry of the Time-limited OFF time, t: The output remains at ON and the Time-limited OFF time, t, is re-started.

Communication objects:

- [6 - Output 1 - Time limited toggle switch object \(1 bit - 1.001 DPT_Switch\)](#)
- [37 - Output 2 - Time limited toggle switch object \(1 bit - 1.001 DPT_Switch\)](#)
- [68 - Output 3 - Time limited toggle switch object \(1 bit - 1.001 DPT_Switch\)](#)

Parameter	Description	Value
Hours (h)	This parameter sets the length of the timer operation for the Time-limited toggle switch, if this is activated.	1 hours: 0 to 23 h
Minutes (min)		0 minutes: 0 to 59 min
Seconds (s)		0 seconds: 0 to 59 s

Note: The smallest executable time is 1 second.

*Note: This parameter is only visible if the **Additional time limited toggle switch function** parameter has the following value: **Active**.*

* Default value

3.6.3 Timer

The Timer function can switch a lighting circuit on or off for a configurable period. According to the selected operating mode of the timer, the output can be turned ON or OFF for a determined period of time. The timer may be interrupted before expiry of the delay time. A programmable Cut-OFF pre-warning announces the end of the delay time by a 1-second inversion of the output status.

Device: 1.1.4 3-fold dimming actuator 300W, universal

Outputs 1-3: Function selection

- O1-3: Manual mode
- O1-3: Status indications

Output 1: Function selection

- O1: Timer

Output 2: Function selection

Output 3: Function selection

Information

Timer operation Value %

Timer duration (h) 0

Timer duration (min) 3

Timer duration (s), minimum value 1s 0

Brightness value during timer (0-100%), last value (101) 101

Dimming speed for brightness value during timer (h) 0

Dimming speed for brightness value during timer (min) 0

Dimming speed for brightness value during timer (s) 0

Cut-OFF pre-warning Active

Hours (h) 0

Minutes (min) 0

Seconds (s) 30

Timer interruption Yes

Timer retriggerability Yes

Timer duration extension (10 first seconds) Unlimited

Timer duration modifiable through object Not active

3.6.3.1 Timer operation

Parameter	Description	Value
Timer operation	When the timer is active, the output for the Timer duration is: Set to the stored value. Alternates between 2 brightness values.(Blink time is configurable via additional parameters.)	Value %* Blinking

* Default value

Parameter	Description	Value
Timer duration	This parameter determines the timer duration.	0 hours: 0 to 23 h 2 minutes: 0 to 59 min 0 seconds: 0 to 59 s

Note: The smallest executable time is 1 second.

Parameter	Description	Value
Brightness value during timer (0-100%), last value (101)	During the timer duration, the output is set to the following value To the stored brightness value. To the last brightness value.	0 ... 100% 101*

Note: This parameter is only visible if the **Timer operation** parameter has the following value: **Value** %.

Parameter	Description	Value
Dimming speed for brightness value during timer	This parameter defines the dimming speed for attaining the brightness value on activation of the timer function.	0 hours: 0 to 23 h 0 minutes: 0 to 59 min 0 seconds: 0 to 59 s

Note: This parameter is only visible if the **Timer operation** parameter has the following value: **Value** %.

Operating principle of the blink function:

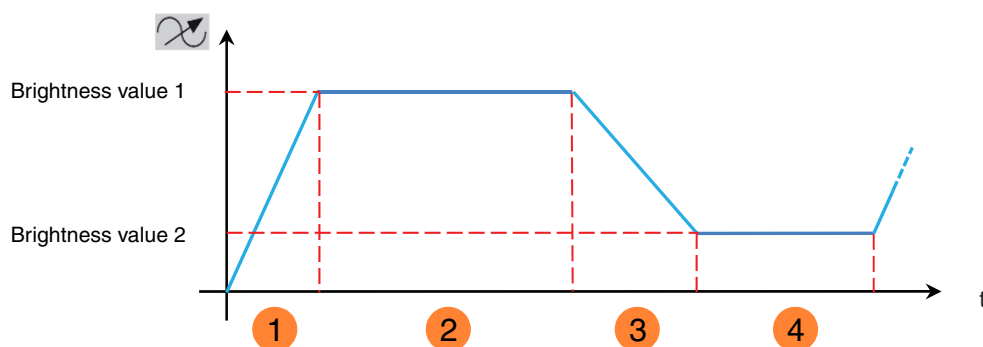

- 1 Dimming speed for brightness value 1
- 2 Brightness value 1 duration
- 3 Dimming speed for brightness value 2
- 4 Brightness value 2 duration

* Default value

Parameter	Description	Value
Brightness val. 1 during blink. (0-100%), last value (101)	Brightness value 1 during Blinking corresponds To the stored brightness value. To the last brightness value.	0 ... 100% 101*

Note: This parameter is only visible if the **Timer operation** parameter has the following value: **Blinking**.

Parameter	Description	Value
Duration brightness value 1 during blinking (s)	Brightness value 1 during blinking is set for the following time.	5 seconds: 5 to 240 s

Note: This parameter is only visible if the **Timer operation** parameter has the following value: **Blinking**.

Parameter	Description	Value
Dimming speed for brightness value * during blinking	This parameter defines the dimming speed for attaining brightness value 1 during blinking.	0 seconds: 0 to 240 s

Note: This parameter is only visible if the **Timer operation** parameter has the following value: **Blinking**.

Parameter	Description	Value
Brightness val. 2 during blink. (0-100%), last value (101)	Brightness value 2 during Blinking corresponds To the stored brightness value. To the last brightness value.	0 ... 100% 101*

Note: This parameter is only visible if the **Timer operation** parameter has the following value: **Blinking**.

Note: If Brightness value 1 and Brightness value 2 are set to maintain the output value at 101, no blinking will be detectable.

Parameter	Description	Value
Duration brightness value 2 during blinking (s)	Brightness value 2 during blinking is set for the following time.	5 seconds: 5 to 240 s

Note: This parameter is only visible if the **Timer operation** parameter has the following value: **Blinking**.

Parameter	Description	Value
Dimming speed for brightness value 2 during blinking	This parameter defines the dimming speed for attaining brightness value 2 during blinking.	0 seconds: 0 to 240 s

Note: This parameter is only visible if the **Timer operation** parameter has the following value: **Blinking**.

* Default value

Parameter	Description	Value
Output status during blinking function	<p>When the switch actuator is blinking, the Status indication ON/OFF object sends:</p> <p>The value, 1 = ON.</p> <p>The value, 0 = OFF.</p> <p>Alternating values depending on the current brightness value. Brightness value = 0, Status indication = 0 Brightness value > 0, Status indication = 1</p>	<p>ON*</p> <p>OFF</p> <p>ON/OFF</p>

*Note: This parameter is only visible if the **Timer operation** parameter has the following value: **Blinking**.*

3.6.3.2 Cut-OFF pre-warning

Parameter	Description	Value
Cut-OFF pre-warning	<p>Before expiry of the timer delay there is:</p> <p>No warning.</p> <p>A warning by dividing the lighting level by 2 during 1 s.</p> <p>The lead time of this warning can be set.</p>	<p>Not active</p> <p>Active*</p>

Parameter	Description	Value
Hours (h)	This parameter determines the lead time of the cut-OFF pre-warning.	0 hours: 0 to 23 h
Minutes (min)		0 minutes: 0 to 59 min
Seconds (s)		30 seconds: 0 to 59 s

Note: The smallest executable time is 1 second.

*Note: This parameter is only visible if the **Cut-OFF pre-warning** parameter has the following value: **Active**.*

Note: If the lead time of the cut-OFF pre-warning is greater than the duration of the timer, the cut-OFF pre-warning is not triggered.

* Default value

3.6.3.3 Configuration

Parameter	Description	Value
Timer interruption	On receiving the value 0 on the Timer communication object, the timing is: Interrupted. Not interrupted.	Yes* No

Parameter	Description	Value
Timer retriggerability	The parameter Timer duration extension (10 first seconds) is: Hidden. Displayed.	No Yes*

Parameter	Description	Value
Timer duration extension (10 first seconds)	If, during the first 10 seconds of the timer duration, multiple commands with the value 1 are received on the Timer communication object, it is: Multiplied unlimited times. Multiplied a maximum of 1x. Multiplied a maximum of 2x. Multiplied a maximum of 3x. Multiplied a maximum of 4x. Multiplied a maximum of 5x.	Unlimited* 1-time duration extension 2-time duration extension 3-time duration extension 4-time duration extension 5-time duration extension

Parameter	Description	Value
Timer duration modifiable through object	The Timer duration communication object is: Hidden. Displayed, the timer duration can be transmitted via the bus.	Not active* Active

Communication objects:

- [10 - Output 1 - Timer duration \(3 byte - 10.001 DPT_TimeOfDay\)](#)
- [41 - Output 2 - Timer duration \(3 byte - 10.001 DPT_TimeOfDay\)](#)
- [72 - Output 3 - Timer duration \(3 byte - 10.001 DPT_TimeOfDay\)](#)

* Default value

3.6.4 Scene

Device: 1.1.4 3-fold dimming actuator 300W, universal

<ul style="list-style-type: none"> Outputs 1-3: Function selection - O1-3: Manual mode - O1-3: Status indications Output 1: Function selection - O1: Scenes Output 2: Function selection Output 3: Function selection Information 	Number of scenes used	8
	Scenes memorisation by long key press	Active
	Scenes memorisation acknowledgment (Output status inverted for 3s)	Not active
	Output status for scene 1	Not active
	Output status for scene 2	Not active
	Output status for scene 3	Not active
	Output status for scene 4	Not active
	Output status for scene 5	Not active
	Output status for scene 6	Not active
	Output status for scene 7	Not active
	Output status for scene 8	Not active
	Brightness val. 1 during blink.(0-100%), last value (101)	100
	Duration brightness value 1 during blinking (s)	5
	Dimming speed for brightness value 1 during blinking (s)	0
	Brightness val. 2 during blink.(0-100%), last value (101)	101
Duration brightness value 2 during blinking (s)	5	
Dimming speed for brightness value 2 during blinking (s)	0	
Output status during blinking function	ON	

Operating principle of the scenes:

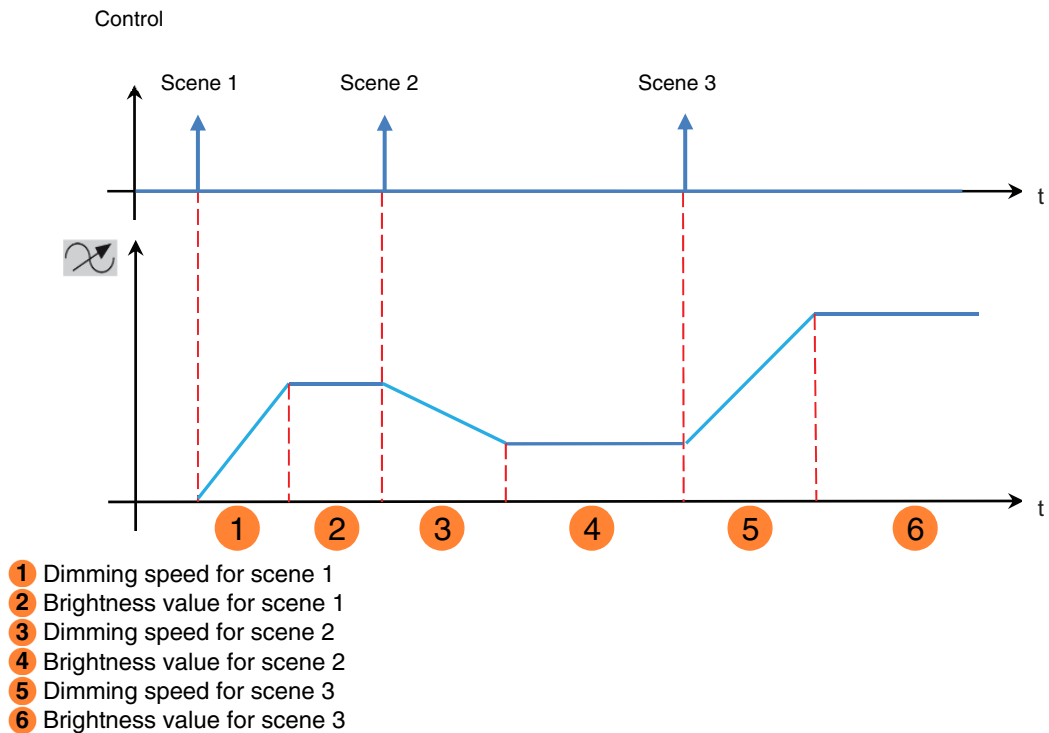

Parameter	Description	Value
Number of scenes used	This parameter determines the number of scenes used.	8* - 16 - 24 - 32 - 48 - 64

Note: If the Scene number received on the Scene object is greater than the maximum number of scenes, the status of the output remains unchanged.

Parameter	Description	Value
Scenes memorisation by very long key press	This parameter allows learning and storing of a scene by, for example, a long press (> 5 seconds) of the corresponding push button.	Not active Active*

Learning and storing scenes

This process is used to change and store a scene. For example, by locally pressing the key in the room or by emission of the values from a visualization.

* Default value

To access and store scenes, the following values must be sent:

Scene number	Access scene (Object value: 1 byte)	Store scene (Object value: 1 byte)
1 - 64	= Scene number - 1	= Scene number + 128
Example		
1	0	128
2	1	129
3	2	130
...	...	
64	63	191

Here is the scene memorisation for local switches, for example.

- Activate scene by briefly pressing the transmitter that starts it.
- The outputs (lights, shutters, etc.) are set in the desired state using the usual local control devices (buttons, remote control, etc.).
- Memorise the status of the outputs with a press greater than 5 seconds long on the transmitter that starts the scene. The memorisation can be displayed by short-term activation of the outputs.

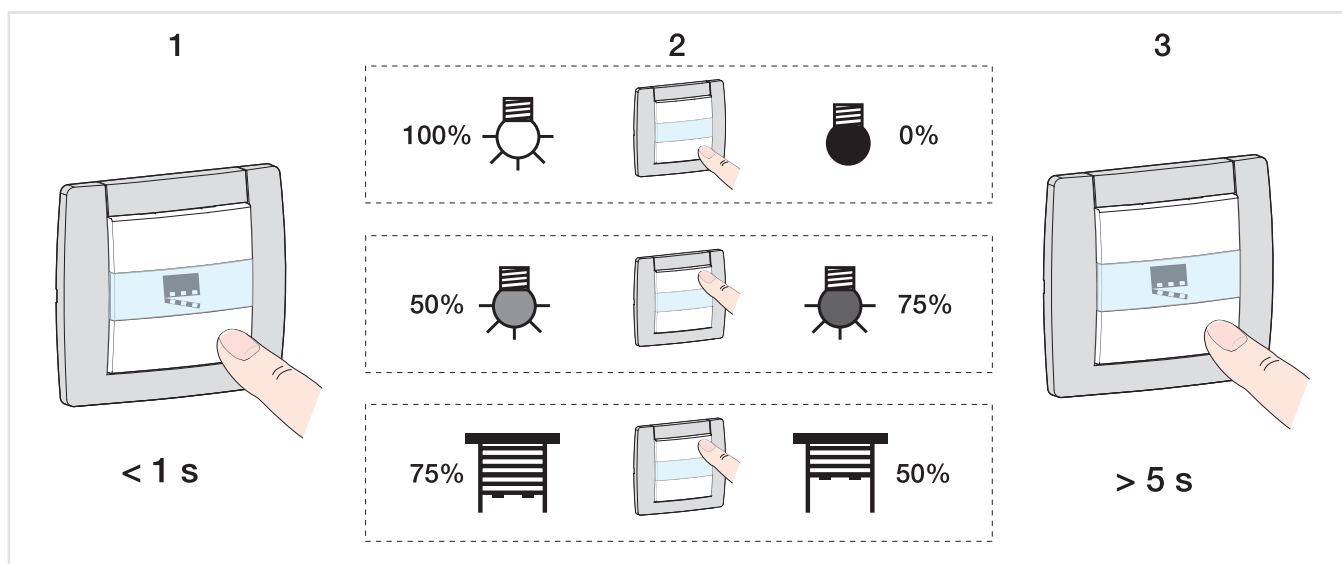

Parameter	Description	Value
Scenes memorisation acknowledgment	Memorisation of a scene is: Not acknowledged. Acknowledged by the output by a 3 second long inversion of the output status.	Not active* Active

* Default value

Parameter	Description	Value
Output status for scene X	On activation of Scene X, the output is: Not changed. Selectively switched on. Selectively switched off. Alternated according to the Blink function. (Blink time is configurable via additional parameters.) Set to the stored value.	Not active* ON OFF Blinking Value %

X = 1 to 64

Note: Each output has up to 64 scenes available, in accordance with the **Number of scenes used** parameter.

Parameter	Description	Value
Brightness value for scene X (0-100%)	This parameter defines the brightness value that is applied to the output when Scene X is selected.	0 ... 100*

X = 1 to 64

Note: This parameter is only visible if the **Output status for scene X** parameter has the following value: **Value %**.

Parameter	Description	Value
Dimming speed for scene X	This parameter defines the dimming speed for attaining the brightness value when Scene X is selected.	0 hours: 0 to 23 h 0 minutes: 0 to 59 min 0 seconds: 0 to 59 s

X = 1 to 64

Note: The smallest executable time is 1 second.

Note: This parameter is only visible if the **Output status for scene X** parameter has the following value: **Value %**.

* Default value

Operating principle of the blink function:

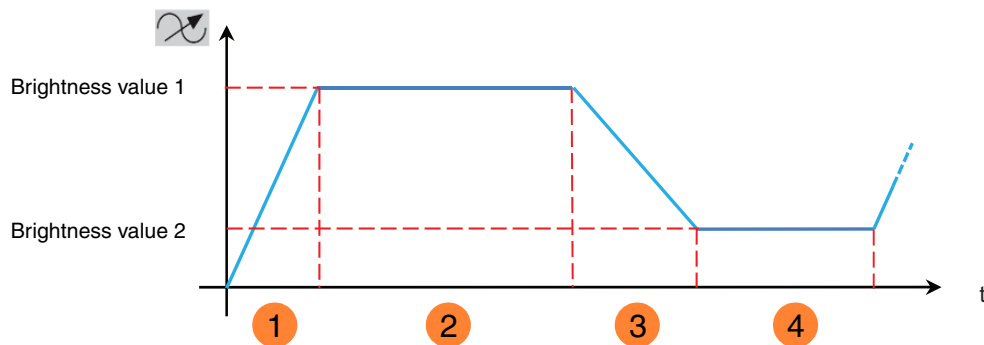

- ① Dimming speed for brightness value 1
- ② Brightness value 1 duration
- ③ Dimming speed for brightness value 2
- ④ Brightness value 2 duration

Parameter	Description	Value
Brightness val. 1 during blink. (0-100%), last value (101)	Brightness value 1 during Blinking corresponds To the stored brightness value. To the last brightness value.	0 ... 100% 101*

Note: This parameter applies to all scenes involving the respective output, which has the following value: **Blinking**.

Parameter	Description	Value
Duration brightness value 1 during blinking (s)	Brightness value 1 during blinking is set for the following time.	5 seconds : 5 to 240 s

Note: This parameter applies to all scenes involving the respective output, which has the following value: **Blinking**.

Parameter	Description	Value
Dimming speed for brightness value 1 during blinking (s)	This parameter defines the dimming speed for attaining brightness value 1 during blinking.	0 seconds : 0 to 240 s

Note: This parameter applies to all scenes involving the respective output, which has the following value: **Blinking**.

Parameter	Description	Value
Brightness val. 2 during blink. (0-100%), last value (101)	Brightness value 2 during Blinking corresponds To the stored brightness value. To the last brightness value.	0 ... 100% 101*

Note: This parameter applies to all scenes involving the respective output, which has the following value: **Blinking**.

* Default value

Parameter	Description	Value
Duration brightness value 2 during blinking (s)	Brightness value 2 during blinking is set for the following time.	5 seconds: 5 to 240 s

*Note: This parameter applies to all scenes involving the respective output, which has the following value: **Blinking**.*

Parameter	Description	Value
Dimming speed for brightness value 2 during blinking (s)	This parameter defines the dimming speed for attaining brightness value 2 during blinking.	0 seconds: 0 to 240 s

*Note: This parameter applies to all scenes involving the respective output, which has the following value: **Blinking**.*

Parameter	Description	Value
Output status during blinking function	When the switch actuator is blinking, the Status indication ON/OFF object sends: The value, 1 = ON. The value, 0 = OFF. Alternating values depending on the current brightness value. Brightness value = 0, Status indication = 0 Brightness value > 0, Status indication = 1	ON* OFF ON/OFF

*Note: This parameter applies to all scenes involving the respective output, which has the following value: **Blinking**.*

* Default value

3.6.5 Preset

Device: 1.1.4 3-fold dimming actuator 300W, universal

<ul style="list-style-type: none"> Outputs 1-3: Function selection - O1-3: Manual mode - O1-3: Status indications Output 1: Function selection - O1: Preset Output 2: Function selection Output 3: Function selection Information 	<p>Preset authorization objects</p> <p>Value of authorization preset 1 at initialization</p> <p>Value of authorization preset 2 at initialization</p> <p>Polarity of Preset 1 authorization object</p> <p>Polarity of Preset 2 authorization object</p> <p>Status if preset 1 object = 0</p> <p>Scene for preset 1 = 0</p> <p>Status if preset 1 object = 1</p> <p>Brightness val. 1 during blink.(0-100%), last value (101)</p> <p>Duration brightness value 1 during blinking (s)</p> <p>Dimming speed for brightness value 1 during blinking (s)</p> <p>Brightness val. 2 during blink.(0-100%), last value (101)</p> <p>Duration brightness value 2 during blinking (s)</p> <p>Dimming speed for brightness value 2 during blinking (s)</p> <p>Output status during blinking function</p> <p>Status if preset 2 object = 0</p> <p>Status if preset 2 object = 1</p>	<p>Active</p> <p>Value before initialization</p> <p>Value before initialization</p> <p>0 = Locked-up , 1 = Authorized</p> <p>0 = Locked-up , 1 = Authorized</p> <p>Scene number</p> <p>1</p> <p>Blinking</p> <p>100</p> <p>5</p> <p>0</p> <p>100</p> <p>5</p> <p>0</p> <p>ON</p> <p>Maintain status</p> <p>Maintain status</p>
--	---	--

The Preset function is used to switch an output into various predefined states. The Preset function is activated via an object in 1-bit format.

Principle of Preset authorization:

The parameters are set as follows:

- Polarity of Preset 1 authorization object: 0 = Locked-up, 1 = Authorized.
- Polarity of Preset 2 authorization object: 0 = Locked-up, 1 = Authorized.
- Status if preset 1 object = 0: ON.
- Status if preset 1 object = 1: OFF.
- Status if preset 2 object = 0: Scene 1.
- Status if preset 2 object = 1: Scene 2.

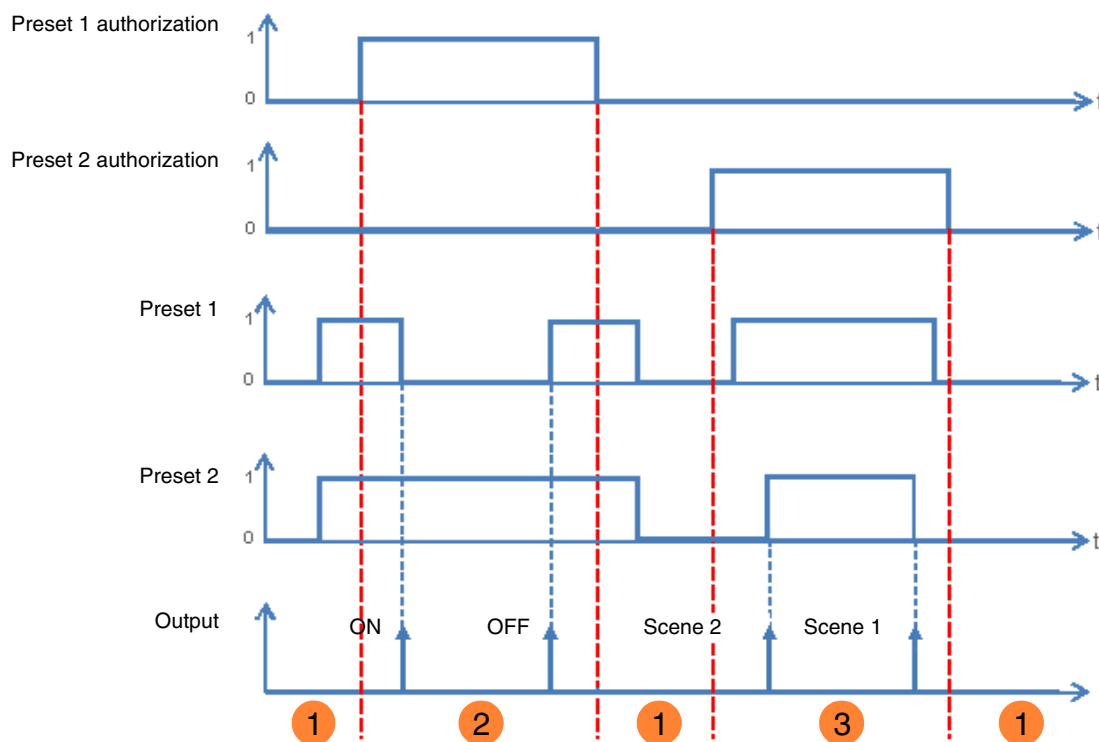

- ❶ The preset inputs have no influence on the output.
- ❷ The commands from Preset 1 are executed.
- ❸ The commands from Preset 2 are executed.

Note: The commands from the Preset will not be executed immediately after authorization, but only when the value of the Preset changes.

Parameter	Description	Value
Preset authorization objects	The Preset 1 authorization communication object and the related parameters are: Hidden. Displayed. This object allows the authorization or lock-up of the Preset 1 function via a KNX telegram.	Not active* Active

Note: The number of available Preset objects is dependent on the **Preset** parameter. A maximum of two of these objects can be available.

Communication objects: [14 - Output 1 - Preset 1 authorization](#) (1 bit - 1.003 DPT_Enable)
[45 - Output 2 - Preset 1 authorization](#) (1 bit - 1.003 DPT_Enable)
[76 - Output 3 - Preset 1 authorization](#) (1 bit - 1.003 DPT_Enable)

Communication objects: [15 - Output 1 - Preset 2 authorization](#) (1 bit - 1.003 DPT_Enable)
[46 - Output 2 - Preset 2 authorization](#) (1 bit - 1.003 DPT_Enable)
[77 - Output 3 - Preset 2 authorization](#) (1 bit - 1.003 DPT_Enable)

Note: The parameters and objects are identical for Preset 2 ; Only the terms will be adjusted.

* Default value

Parameter	Description	Value
Value of authorization preset 1 at initialization	On initialization of the device after a download or after return of the bus power, the value of the Preset 1 authorization object is: Set to 0. Set to 1. Set according to the value of the logic input before the initialization occurred.	0 1 Value before initialization*

Note: This parameter is only visible if the **Preset authorization objects** parameter has the following value: **Active**.

Parameter	Description	Value
Polarity of Preset 1 authorization object	On receipt of a value on the Preset 1 authorization object, Preset 1 : Locked-up on object value 1. Locked-up on object value 0.	0 = Locked-up, 1 = Authorized* 0 = Authorized, 1 = Locked-up

Note: This parameter is only visible if the **Preset authorization objects** parameter has the following value: **Active**.

Parameter	Description	Value
Status if preset 1 object = 0	On receipt of the value 0 on the Preset 1 object, the output is: Not changed. Is switched to the opposite status. Selectively switched on. Selectively switched off. Set to the stored value. Set to a scene value. Set in blinking mode. Switched to the status that was active before last receiving the value 1 on the Preset 1 object.	Maintain status* Inversion ON OFF Value % Scene number Blinking Status before preset 1 = 1

Parameter	Description	Value
Brightness value if object preset 1=0 (0-100%)	This parameter determines the brightness value which will be applied to the respective output if the Preset 1 object receives the value 0.	0 ... 100*

Note: This parameter is only visible if the **Status if preset 1 object = 0** parameter has the following value: **Value %**.

Parameter	Description	Value
Dimming speed for the brightness value during Preset 1 = 0	This parameter determines the dimming speed to attain the brightness value of the respective output if the Preset 1 object receives the value 0.	1 hours: 0 to 23 h 0 minutes: 0 to 59 min 0 seconds: 0 to 59 s

Note: This parameter is only visible if the **Status if preset 1 object = 0** parameter has the following value: **Value %**.

* Default value

Parameter	Description	Value
Scene for preset 1 = 0	This parameter determines the value of the scene if: The Preset 1 object has value 0. The Status if preset 1 object = 0 object has the scene value.	Scene 1 ... 64 Default value: 1

Note: This parameter is only visible if the **Status if preset 1 object = 0** parameter has the following value: **Scene number**.

Parameter	Description	Value
Status if preset 1 object = 1	On receipt of the value 1 on the Preset 1 object, the output is: Not changed. Is switched to the opposite status. Selectively switched on. Selectively switched off. Set to the stored value. Set to a scene value. Set in blinking mode. Switched to the status that was active before last receiving the value 1 on the Preset 1 object.	Maintain status* Inversion ON OFF Value % Scene number Blinking Status before preset 1 = 0

Parameter	Description	Value
Brightness value if object preset 1=1 (0-100%)	This parameter determines the brightness value which will be applied to the respective output if the Preset 1 object receives the value 1.	0 ... 100*

Note: This parameter is only visible if the **Status if preset 1 object = 1** parameter has the following value: **Value %**.

Parameter	Description	Value
Dimming speed for the brightness value during Preset 1 = 1	This parameter determines the dimming speed to attain the brightness value of the respective output if the Preset 1 object receives the value 1.	0 hours: 0 to 23 h 0 minutes: 0 to 59 min 0 seconds: 0 to 59 s

Note: This parameter is only visible if the **Status if preset 1 object = 1** parameter has the following value: **Value %**.

Parameter	Description	Value
Scene number for preset 1 = 1	This parameter determines the value of the scene if: The Preset 1 object has value 1. The Status if preset 1 object = 1 object has the scene value.	Scene 1 ... 64 Default value: Scene 1

Note: This parameter is only visible if the **Status if preset 1 object = 1** parameter has the following value: **Scene number**.

If the **Status on preset 1 object = 0** parameter, **Status on preset 1 = 1 object**, **Status on preset 2 = 0 object** and **Status on preset 2 = 1 object** have the value **Blinking**, the Blink parameter is configured as follows.

* Default value

Operating principle of the blink function:

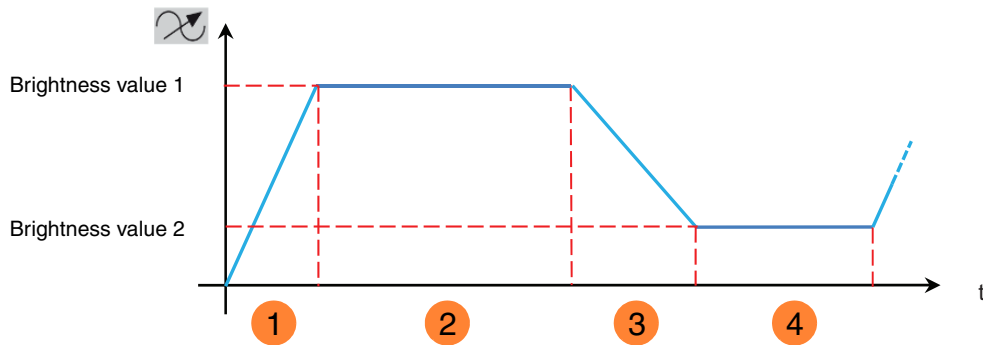

- ① Dimming speed for brightness value 1
- ② Brightness value 1 duration
- ③ Dimming speed for brightness value 2
- ④ Brightness value 2 duration

Parameter	Description	Value
Brightness val. 1 during blink. (0-100%), last value (101)	Brightness value 1 during Blinking corresponds To the stored brightness value. To the last brightness value.	0 ... 100% 101*

*Note: This parameter is only visible if the **Status if preset 1 object = 0** parameter or the **Status if preset 1 object = 1** parameter has the following value: **Blinking**.*

Parameter	Description	Value
Duration brightness value 1 during blinking (s)	Brightness value 1 during blinking is set for the following time.	5 seconds: 5 to 240 s

*Note: This parameter is only visible if the **Timer operation** parameter has the following value: **Blinking**.*

Parameter	Description	Value
Dimming speed for brightness value 1 during blinking (s)	This parameter defines the dimming speed for attaining brightness value 1 during blinking.	0 seconds: 0 to 240 s

This parameter is only visible if the **Status if preset 1 object = 0** parameter or the **Status if preset 1 object = 1** parameter has the following value: **Blinking**.

Parameter	Description	Value
Brightness val. 2 during blink. (0-100%), last value (101)	Brightness value 2 during Blinking corresponds To the stored brightness value. To the last brightness value.	0 ... 100% 101*

*Note: This parameter is only visible if the **Status if preset 1 object = 0** parameter or the **Status if preset 1 object = 1** parameter has the following value: **Blinking**.*

* Default value

Parameter	Description	Value
Duration brightness value 2 during blinking (s)	Brightness value 2 during blinking is set for the following time.	5 seconds: 5 to 240 s

*Note: This parameter is only visible if the **Status if preset 1 object = 0** parameter or the **Status if preset 1 object = 1** parameter has the following value: **Blinking**.*

Parameter	Description	Value
Dimming speed for brightness value 2 during blinking (s)	This parameter defines the dimming speed for attaining brightness value 2 during blinking.	0 seconds: 0 to 240 s

This parameter is only visible if the **Status if preset 1 object = 0** parameter or the **Status if preset 1 object = 1** parameter has the following value: **Blinking**.

Parameter	Description	Value
Output status during blinking function	When the switch actuator is blinking, the Status indication ON/OFF object sends: The value, 1 = ON. The value, 0 = OFF. Alternating values depending on the current brightness value. Brightness value = 0, Status indication = 0 Brightness value > 0, Status indication = 1	ON* OFF ON/OFF

*Note: This parameter is only visible if the **Status if preset 1 object = 0** parameter or the **Status if preset 1 object = 1** parameter has the following value: **Blinking**.*

* Default value

3.6.6 Lock-up

Device: 1.1.4 3-fold dimming actuator 300W, universal

<ul style="list-style-type: none"> Outputs 1-3: Function selection - O1-3: Manual mode - O1-3: Status indications Output 1: Function selection <li style="background-color: #e0e0e0;">- O1: Lock-up Output 2: Function selection Output 3: Function selection Information 	<p>Lock-up type: <input type="text" value="Output lock-up"/></p> <p>Lock-up duration: <input type="text" value="Permanently"/></p> <p>Polarity of lock-up object 1: <input type="text" value="0 = Lock-up deactivated, 1 = Lock-up activated"/></p> <p>Polarity of lock-up object 2: <input type="text" value="0 = Lock-up deactivated, 1 = Lock-up activated"/></p> <p>Priority between lock-up 1 and lock-up 2: <input type="text" value="Lock-up 1 > Lock-up 2"/></p> <p>Status during lock-up 1: <input type="text" value="Maintain status"/></p> <p>Status during lock-up 2: <input type="text" value="Maintain status"/></p> <p>Status after lock-up function 1: <input type="text" value="Maintain status"/></p> <p>Status after lock-up function 2: <input type="text" value="Maintain status"/></p> <p>Activation of lock-up status object: <input type="text" value="Active"/></p> <p>Polarity: <input type="text" value="0 = Lock-up deactivated, 1 = Lock-up activated"/></p> <p>Emission: <input type="text" value="On status change and periodically"/></p> <p>Hours (h): <input type="text" value="0"/></p> <p>Minutes (min): <input type="text" value="10"/></p> <p>Seconds (s): <input type="text" value="0"/></p>
---	--

The Lock-up function is used to lock the output in a predefined state.
 Priority: Manual mode > Priority > **Lock-up** > Basic function.
 The Lock-up prevents actuation until an unlock command has been received.
 The Lock-up duration can be set.

Parameter	Description	Value
Lock-up type	The Lock-up acts: Directly on the switch actuator. As long as the Lock-up is active, the output can only be controlled by higher priority commands. On selected communication objects. As long as the Lock-up is active, the output can only be controlled via specific selectable objects.	Output lock-up* Object lock-up

* Default value

Parameter	Description	Value
Lock-up duration	The duration of the Lock-up is Not time limited, the lock-up is only authorized by means of a telegram on Lock-up 1 object. Is active for a limited time, the control of the output is authorized after expiry of this time.	Permanently* Time limited

Parameter	Description	Value
Hours (h)	This parameter determines the activation time of the Lock-up.	0 hours: 0 to 23 h
Minutes (min)		15 minutes: 0 to 59 min
Seconds (s)		0 seconds: 0 to 59 s

Note: The smallest executable time is 1 second.

Note: This parameter is only visible if the **Lock-up duration** parameter has the following value: **Time limited**.

Parameter	Description	Value
Polarity of lock-up object 1	On receipt of a value on the Lock-up 1 object, the lock-up: Locked-up on object value 1. Is deactivated on object value 0. Locked-up on object value 0. Is deactivated on object value 1.	0 = Lock-up deactivated, 1 = Lock-up activated* 0 = Lock-up activated, 1 = Lock-up deactivated

Note: The parameters and objects are identical for Lock-up 2 ; Only the terms will be adjusted.

Parameter	Description	Value
Priority between lock-up 1 and lock-up 2	The priority between lock-up 1 and lock-up 2 is set as follows: Lock-up 1 has priority over lock-up 2. Lock-up 2 has priority over lock-up 1. Lock-up 1 and lock-up 2 have the same priority.	Lock-up 1 > Lock-up 2* Lock-up 1 < Lock-up 2 Lock-up 1 = Lock-up 2

Note: This parameter is only visible if the **Lock-up** parameter has the following value: **Active with 2 lock-up objects**.

Note: The priority of the Lock-up always functions in the same way, independently of the lock-up type (Output lock-up or object lock-up).

* Default value

Operating principle of the priorities:
If Lock-up 1 > Lock-up 2

Active lock-up	Activation order of Lock-up 1	Activation order of Lock-up 2
None	Lock-up 1 is activated	Lock-up 2 is activated
Lock-up 1	Lock-up 1 remains active	Despite the activation order of Lock-up 2, Lock-up 1 remains activated
Lock-up 2	Lock-up 1 is activated	Lock-up 2 remains active

If Lock-up 1 = Lock-up 2

Active lock-up	Activation order of Lock-up 1	Activation order of Lock-up 2
None	Lock-up 1 is activated	Lock-up 2 is activated
Lock-up 1	Lock-up 1 remains active	Lock-up 2 is activated
Lock-up 2	Lock-up 1 is activated	Lock-up 2 remains active

If Lock-up 1 < Lock-up 2

Active lock-up	Activation order of Lock-up 1	Activation order of Lock-up 2
None	Lock-up 1 is activated	Lock-up 2 is activated
Lock-up 1	Lock-up 1 remains active	Lock-up 2 is activated
Lock-up 2	Despite the activation order of Lock-up 1, Lock-up 2 remains activated	Lock-up 2 remains active

Parameter	Description	Value
Status during lock-up 1	If the Lock-up type is set to Output lock-up , on activation of the lock-up the output will: Not changed. Switch to the opposite status. Selectively switched on. Selectively switched off. Set to the stored value.	Maintain status* Inversion ON OFF Value %

Note on inversion: If the brightness value is greater than or equal to 1%, the value goes to 0%. If the brightness value is less than 1%, the value goes to 100%.

Note: The parameters and objects are identical for Lock-up 2 ; Only the terms will be adjusted.

Lock-up 1 authorizes object:

The parameters listed below allow the selection of the objects for controlling the output via the nevertheless active Lock-up.

*Note: These parameters are only visible if the **Lock-up type** parameter has the following value: **Object lock-up**.*

* Default value

Parameter	Objects concerned	Value
ON/OFF	ON/OFF	Yes No*
Scene	Scene	Yes No*
Timer	Timer	Yes No*
Timer/toggle switch changeover	Timer/toggle switch changeover	Yes No*
Time limited toggle switch	Time limited toggle switch	Yes No*
Preset 1	Preset 1	Yes No*
Preset 2	Preset 2	Yes No*

Note: The parameters and objects are identical for Lock-up 2 ; Only the terms will be adjusted.

Parameter	Description	Value
Status after lock-up function 1	<p>If the Lock-up type is set to Output lock-up, on cancellation of the lock-up the output will:</p> <p>Not changed.</p> <p>Switch to the opposite status.</p> <p>Selectively switched on.</p> <p>Selectively switched off.</p> <p>Set to the stored value.</p> <p>Return to the status that was active before the lock-up.</p> <p>Set to the status which would be active according to other communication objects had no lock-up taken place.</p>	<p>Maintain status*</p> <p>Inversion</p> <p>ON</p> <p>OFF</p> <p>Value %</p> <p>Status before lock-up 1</p> <p>Theoretical status without lock-up function 1</p>

Note on inversion: If the brightness value is greater than or equal to 1%, the value goes to 0%. If the brightness value is less than 1%, the value goes to 100%.

Note: The application of this parameter depends on the priority of the other active functions. If a function with higher priority is active, this parameter will not be enacted. In the case where two functions with the same priority are active, the parameter of the most recently switched off function is enacted.

Note: The parameters and objects are identical for Lock-up 2 ; Only the terms will be adjusted.

Parameter	Description	Value
Activation of lock-up status object	<p>The Status indication lock-up communication object is hidden.</p> <p>The Status indication lock-up communication object is displayed.</p>	<p>Not active*</p> <p>Active</p>

Communication objects:

- [13 - Output 1 - Status indication lock-up \(1 bit - 1.011 DPT_State\)](#)
- [45 - Output 2 - Status indication lock-up \(1 bit - 1.011 DPT_State\)](#)
- [77 - Output 3 - Status indication lock-up \(1 bit - 1.011 DPT_State\)](#)

* Default value

Parameter	Description	Value
Polarity	The Status indication Lock-up communication object sends: 0 on deactivation of the lock-up. 1 on activation of the lock-up. 0 on activation of the lock-up. 1 on deactivation of the lock-up.	0 = Lock-up deactivated, 1 = Lock-up activated* 0 = Lock-up activated, 1 = Lock-up deactivated

Parameter	Description	Value
Emission	The Status indication lock-up communication object is sent: On activation and deactivation of the lock-up. Periodically after a configurable time. On activation and deactivation of the lock-up and periodically after a configurable time.	On status change* Periodically On status change and periodically

*Note: This parameter is only visible if the **Activation of Lock-up status object** parameter has the following value: **Active**.*

Parameter	Description	Value
Hours (h)	This parameter determines the time between the individual transmissions of the Status indication lock-up object.	0 hours: 0 to 23 h
Minutes (min)		10 minutes: 0 to 59 min
Seconds (s)		0 seconds: 0 to 59 s

Note: The smallest executable time is 1 second.

*Note: This parameter is only visible if the **Emission** parameter has the following value: **Periodically** or **On status change and periodically**.*

* Default value

3.6.7 Priority

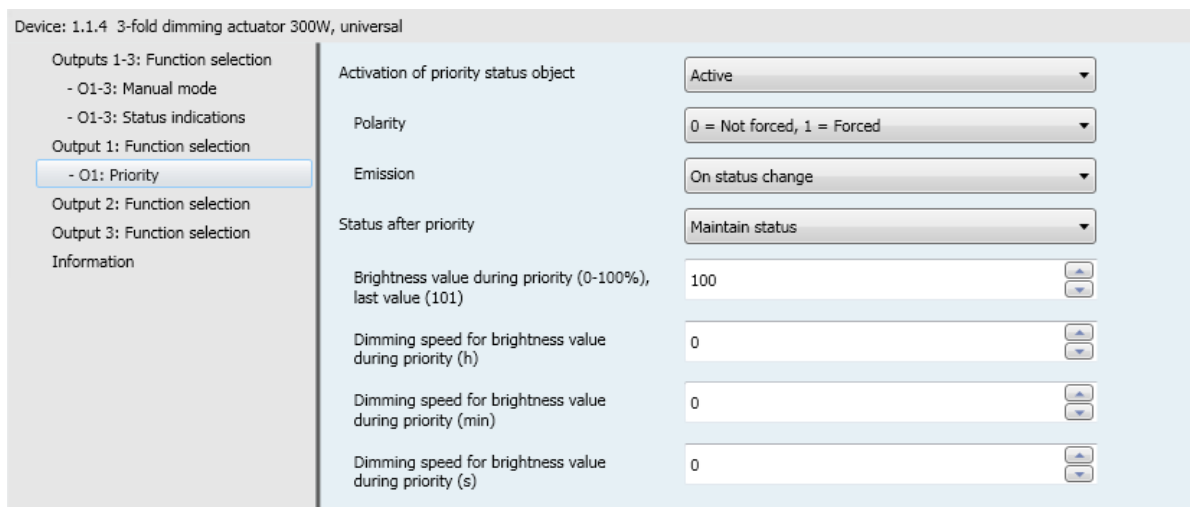

The Priority is used to force the output into a predefined state.

Priority: Manual mode > **Priority** > Lock-up > Basic function.

No other command is taken into account when the Priority is active. Only by ending the Priority are other commands again permitted.

Parameter	Description	Value
Activation of priority status object	The Status indication priority communication object and related parameters are hidden.	Not active*
	The Status indication priority communication object and related parameters are displayed.	Active

- Communication objects:
- [20 - Output 1 - Status indication priority \(1 bit - 1.011 DPT_State\)](#)
 - [51 - Output 2 - Status indication priority \(1 bit - 1.011 DPT_State\)](#)
 - [82 - Output 3 - Status indication priority \(1 bit - 1.011 DPT_State\)](#)

Parameter	Description	Value
Polarity	The Status indication priority communication object sends: 0 on deactivation of the Priority. 1 on activation of the Priority. 0 on activation of the Priority. 1 on deactivation of the Priority.	0 = Not forced, 1 = Forced* 0 = Forced, 1 = Not forced

Note: This parameter is only visible if the **Activation of priority status object** parameter has the following value: **Active**.

* Default value

Parameter	Description	Value
Emission	The Status indication priority communication object is sent: On activation and deactivation of the Priority. Periodically after a configurable time. On activation and deactivation of the Priority and periodically after a configurable time.	On status change* Periodically On status change and periodically

Note: This parameter is only visible if the **Activation of priority status object** parameter has the following value: **Active**.

Parameter	Description	Value
Hours (h)	This parameter determines the time between the individual transmissions of the Status indication priority object.	0 hours: 0 to 23 h
Minutes (min)		10 minutes: 0 to 59 min
Seconds (s)		0 seconds: 0 to 59 s

Note: The smallest executable time is 1 second.

Note: This parameter is only visible if the **Emission** parameter has the following value: **Periodically** or **On status change and periodically**.

Parameter	Description	Value
Status after priority	At the end of the priority, the output is: Not changed. Switch to the opposite status. Selectively switched on. Selectively switched off. Set to the stored value. Switched back to the status before priority was activated. Switched to the status which would be active according to other communication objects if the priority had not taken place.	Maintain status* Inversion ON OFF Value % Status before priority Theoretical status without priority

Note on inversion: If the brightness value is greater than or equal to 1%, the value goes to 0%. If the brightness value is less than 1%, the value goes to 100%.

Note: The application of this parameter depends on the priority of the other active functions. If a function with higher priority is active, this parameter will not be enacted. In the case where two functions with the same priority are active, the parameter of the most recently switched off function is enacted.

Parameter	Description	Value
Brightness value after priority (0-100%)	This parameter defines the brightness value that is applied on the output after the end of priority.	0 ... 100*

Note: This parameter is only visible if the **Status after priority** parameter has the following value: **Value %**.

* Default value

Parameter	Description	Value
Dimming speed for brightness value after priority	This parameter defines the dimming speed for attaining the brightness value of the output after ending of the priority.	0 hours: 0 to 23 h 0 minutes: 0 to 59 min 0 seconds: 0 to 59 s

Note: This parameter is only visible if the **Status after priority** parameter has the following value: **Value %**.

Parameter	Description	Value
Brightness value during priority (0-100%), last value (101)	During the priority, the brightness value corresponds to. To the stored brightness value. To the last brightness value.	0 ... 100* 101

Parameter	Description	Value
Dimming speed for brightness value during priority	This parameter defines the dimming speed for attaining the brightness value of the output during the priority.	0 hours: 0 to 23 h 0 minutes: 0 to 59 min 0 seconds: 0 to 59 s

* Default value

3.6.8 Hours counter

The Hours Counter function is used to count the overall operating time of an output in the ON or OFF state. The operating hours counter setpoint can be programmed and altered via an object.

Device: 1.1.4 3-fold dimming actuator 300W, universal

Outputs 1-3: Function selection

- O1-3: Manual mode
- O1-3: Status indications

Output 1: Function selection

- O1: Hours counter

Output 2: Function selection

Output 3: Function selection

Information

Relay status for operating hours counter Closed ▾

Hours counter direction Increment ▾

Operating h. counter setpoint 10000

Counter setpoint value modifiable through object Not active ▾

Emission hours counter value On status change and periodically ▾

Value interval (h) 100

Periodical emission delay (h) 1

Periodical emission delay (min) 0

Periodical emission delay (s) 0

Object emission counter setpoint reached Periodically ▾

Periodical emission delay (h) 1

Periodical emission delay (min) 0

Periodical emission delay (s) 0

Parameter	Description	Value
Relay status for operating hours counter	The hours counter runs if: The brightness value is > 0. The brightness value = 0.	Closed* Opened

Parameter	Description	Value
Hours counter direction	The hours counter counts: Growing. Decreasing.	Increment* Countdown

* Default value

Increment:

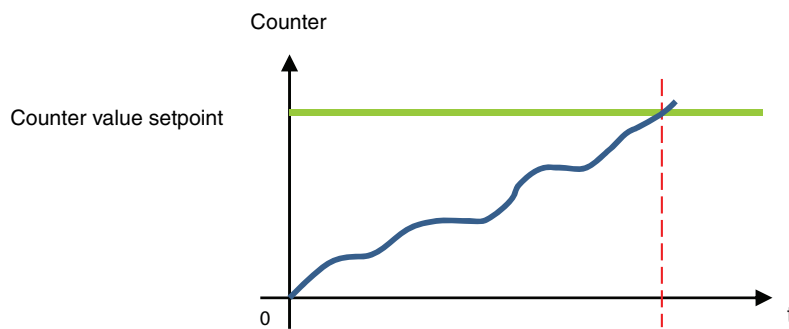

The counter starts to count up from the value 0. As soon as the counter setpoint (**Hours counter setpoint** object) is reached, the **Hours counter setpoint reached** object is set to 1 and sent to the bus.

Countdown:

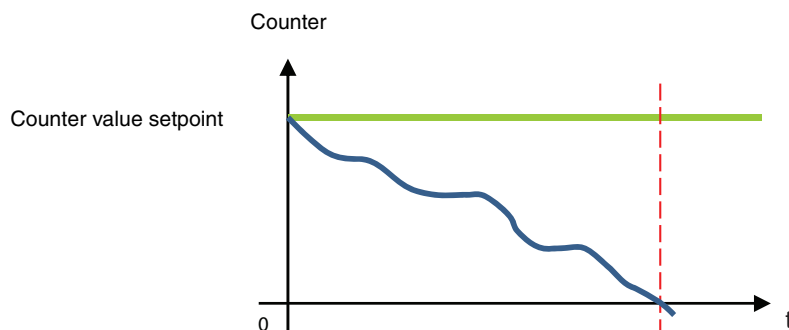

The counter starts to count down from the operating hours counter setpoint (**Hours counter setpoint** object). As soon as the counter reaches 0, the **Hours counter setpoint reached** is set to 1 and sent to the bus.

Parameter	Description	Value
Hours counter setpoint	This parameter determines the value of the hours counter.	1 ... 10000* ... 65535

An incrementing counter starts at 0 and counts up until it reaches the setpoint value.
A countdown counter starts to count at the setpoint value and counts down until it has arrived at 0.

Parameter	Description	Value
Counter setpoint value modifiable through object	The Hours counter setpoint communication object is hidden.	Not active*
	The Hours counter setpoint communication object is displayed. The value can be changed via the KNX bus.	Active

- Communication objects:
- [24 - Output 1 - Hours counter setpoint \(2 byte - 7.001 DPT_16_bit_Counter\)](#)
 - [55 - Output 2 - Hours counter setpoint \(2 byte - 7.001 DPT_16_bit_Counter\)](#)
 - [86 - Output 3 - Hours counter setpoint \(2 byte - 7.001 DPT_16_bit_Counter\)](#)

* Default value

Parameter	Description	Value
Emission hours counter value	The Hours counter value communication object is sent: On each change. Periodically after a configurable time. On change and periodically after a configurable time.	On status change* Periodically On status change and periodically

Parameter	Description	Value
Value interval (h)	This parameter specifies the value interval (in hours) for the sending frequency of the Hours counter setpoint object.	1 ... 100* ... 65535 (hours)

*Note: If the value interval is 200 hours, then the **Hours counter setpoint** object is sent each time the Operating h. counter value is increased by 200 hours.*

*Note: This parameter is only visible if the **Emission hours counter value** parameter has the following value: **Periodically** or **On status change and periodically**.*

Parameter	Description	Value
Periodical emission delay	This parameter determines the time between the individual transmissions of the Hours counter setpoint object.	1 hours: 0 to 23 h 0 minutes: 0 to 59 min 0 seconds: 0 to 59 s

Note: The smallest executable time is 1 second.

*Note: This parameter is only visible if the **Emission hours counter value** parameter has the following value: **Periodically** or **On status change and periodically**.*

Parameter	Description	Value
Emission object counter setpoint reached	The Hours counter setpoint reached communication object is sent: On reaching the counter setpoint. Periodically after a configurable time. On reaching the counter setpoint and periodically after a configurable time.	On status change Periodically* On status change and periodically

Parameter	Description	Value
Periodical emission delay	This parameter determines the time between the individual transmissions of the Hours counter setpoint reached object.	1 hours: 0 to 23 h 0 minutes: 0 to 59 min 0 seconds: 0 to 59 s

Note: The smallest executable time is 1 second.

*Note: This parameter is only visible if the Object **Emission counter setpoint reached** parameter has the following value: **Periodically** or **On status change and periodically**.*

* Default value

3.6.9 Notifications

Device: 1.1.4 3-fold dimming actuator 300W, universal

Outputs 1-3: Function selection

- O1-3: Manual mode
- O1-3: Status indications

Output 1: Function selection

- O1: Notification

Output 2: Function selection

Output 3: Function selection

Information

Object dimming mode	Active	
Emission	Periodically	
Periodical emission delay (h)	0	▲ ▼
Periodical emission delay (min)	15	▲ ▼
Periodical emission delay (s)	0	▲ ▼
Object overload	Active	
Emission	On status change	
Object shortcircuit	Active	
Emission	On status change	
Object over voltage	Active	
Emission	On status change	
Object over temperature	Active	
Emission	On status change	
Object load default	Active	
Emission	On status change	

3.6.9.1 Dimming mode

Parameter	Description	Value
Object dimming mode	This parameter is used to authorize the Dimming mode object . This object enables the dimming mode to be sent.	Not active* Active

Parameter	Description	Value
Emission	The Dimming mode communication object is sent: On switching manual mode on or off. Periodically after a configurable time. On switching manual mode on or off and periodically after a configurable time.	On status change* Periodically On status change and periodically

*Note: This parameter is only visible if the **Object Dimming mode** parameter has the following value: **Active**.*

* Default value

Parameter	Description	Value
Periodical emission delay	This parameter determines the time between the individual transmissions of the Dimming mode object.	0 hours: 0 to 23 h 15 minutes: 0 to 59 min 0 seconds: 0 to 59 s

Note: The smallest executable time is 1 second.

Note: This parameter is only visible if the **Emission** parameter has the following value: **Periodically** or **On status change and periodically**.

3.6.9.2 Overload

Parameter	Description	Value
Object overload	This parameter is used to authorize the Overload object . This object is used for notification of an overload on the output concerned, via the KNX bus. An overload arises, for example, when several lamps are connected to the output, exceeding its rated power.	Not active* Active

Communication objects:

[26 - Output 1 - Overload \(1 bit - 1.005 DPT_Alarm\)](#)

[57 - Output 2 - Overload \(1 bit - 1.005 DPT_Alarm\)](#)

[88 - Output 3 - Overload \(1 bit - 1.005 DPT_Alarm\)](#)

Parameter	Description	Value
Emission	The Overload communication object is sent: On switching manual mode on or off. Periodically after a configurable time. On switching manual mode on or off and periodically after a configurable time.	On status change* Periodically On status change and periodically

Note: This parameter is only visible if the **Object Overload** parameter has the following value: **Active**.

Parameter	Description	Value
Periodical emission delay	This parameter determines the time between the individual transmissions of the Overload object.	0 hours: 0 to 23 h 15 minutes: 0 to 59 min 0 seconds: 0 to 59 s

Note: The smallest executable time is 1 second.

Note: This parameter is only visible if the **Emission** parameter has the following value: **Periodically** or **On status change and periodically**.

* Default value

3.6.9.3 Short circuit

Parameter	Description	Value
Objet shortcircuit	This parameter is used to authorize the Short circuit object. This object is used for notification of a short circuit on the output concerned, via the KNX bus.	Not active* Active

Communication objects:

- [27 - Output 1 - Short circuit \(1 bit - 1.005 DPT_Alarm\)](#)
- [58 - Output 2 - Short circuit \(1 bit - 1.005 DPT_Alarm\)](#)
- [89 - Output 3 - Short circuit \(1 bit - 1.005 DPT_Alarm\)](#)

Parameter	Description	Value
Emission	The Short circuit communication object is sent: On switching manual mode on or off. Periodically after a configurable time. On switching manual mode on or off and periodically after a configurable time.	On status change* Periodically On status change and periodically

*Note: This parameter is only visible if the **Short circuit** parameter has the following value: **Active**.*

Parameter	Description	Value
Periodical emission delay	This parameter determines the time between the individual transmissions of the Short circuit object.	0 hours: 0 to 23 h 15 minutes: 0 to 59 min 0 seconds: 0 to 59 s

Note: The smallest executable time is 1 second.

*Note: This parameter is only visible if the **Emission** parameter has the following value: **Periodically** or **On status change and periodically**.*

3.6.9.4 Over voltage

Parameter	Description	Value
Object over voltage	This parameter is used to authorize the Over voltage object. This object is used for notification of a short circuit on the output concerned, via the KNX bus.	Not active* Active

Communication objects:

- [28 - Output 1 - Over voltage \(1 bit - 1.005 DPT_Alarm\)](#)
- [59 - Output 2 - Over voltage \(1 bit - 1.005 DPT_Alarm\)](#)
- [90 - Output 3 - Over voltage \(1 bit - 1.005 DPT_Alarm\)](#)

* Default value

Parameter	Description	Value
Emission	The Over voltage communication object is sent: On switching manual mode on or off. Periodically after a configurable time. On switching manual mode on or off and periodically after a configurable time.	On status change* Periodically On status change and periodically

Note: This parameter is only visible if the **Object Dimming mode** parameter has the following value: **Active**.

Parameter	Description	Value
Periodical emission delay	This parameter determines the time between the individual transmissions of the Short circuit object.	0 hours: 0 to 23 h 15 minutes: 0 to 59 min 0 seconds: 0 to 59 s

Note: The smallest executable time is 1 second.

Note: This parameter is only visible if the **Emission** parameter has the following value: **Periodically** or **On status change and periodically**.

3.6.9.5 Over temperature

Parameter	Description	Value
Object over temperature	This parameter is used to authorize the Over temperature object. This object is used for notification of an over temperature on the output concerned, via the KNX bus. An over temperature arises when a load is connected to the output that results in a temperature increase in the output current circuit.	Not active* Active

Communication objects:

- [29 - Output 1 - Over temperature \(1 bit - 1.005 DPT_Alarm\)](#)
- [60 - Output 2 - Over temperature \(1 bit - 1.005 DPT_Alarm\)](#)
- [91 - Output 3 - Over temperature \(1 bit - 1.005 DPT_Alarm\)](#)

Parameter	Description	Value
Emission	The Over temperature communication object is sent: On switching manual mode on or off. Periodically after a configurable time. On switching manual mode on or off and periodically after a configurable time.	On status change* Periodically On status change and periodically

Note: This parameter is only visible if the **Object over temperature** parameter has the following value: **Active**.

* Default value

Parameter	Description	Value
Periodical emission delay	This parameter determines the time between the individual transmissions of the Over temperature object.	0 hours: 0 to 23 h 15 minutes: 0 to 59 min 0 seconds: 0 to 59 s

Note: The smallest executable time is 1 second.

Note: This parameter is only visible if the **Emission** parameter has the following value: **Periodically** or **On status change and periodically**.

3.6.9.6 Load default

Parameter	Description	Value
Object load default	This parameter is used to authorize the object load default . This object is used for notification of a load default on the output concerned, via the KNX bus. Load default means that the output has no load or a defective load.	Not active* Active

Communication objects:

- [30 - Output 1 - Load default \(1 bit - 1.005 DPT_Alarm\)](#)
- [61 - Output 2 - Load default \(1 bit - 1.005 DPT_Alarm\)](#)
- [92 - Output 3 - Load default \(1 bit - 1.005 DPT_Alarm\)](#)

Parameter	Description	Value
Emission	The Load default communication object is sent: On switching manual mode on or off. Periodically after a configurable time. On switching manual mode on or off and periodically after a configurable time.	On status change* Periodically On status change and periodically

Note: This parameter is only visible if the **Object load default** parameter has the following value: **Active**.

Parameter	Description	Value
Periodical emission delay	This parameter determines the time between the individual transmissions of the Load default object.	0 hours: 0 to 23 h 15 minutes: 0 to 59 min 0 seconds: 0 to 59 s

Note: The smallest executable time is 1 second.

Note: This parameter is only visible if the **Emission** parameter has the following value: **Periodically** or **On status change and periodically**.

* Default value

4. Communication objects

4.1 Communication objects General

	Number	Name	Function of the object	Length	C	R	W	T
	93	Outputs 1-3	Deactivation of manual mode	1 bit	C	R	W	-
	94	Outputs 1-3	Status indication manual mode	1 bit	C	R	-	T
	95	Logic block 1	Authorization	1 bit	C	R	W	-
	96	Logic block 1	Input 1	1 bit	C	R	W	-
	97	Logic block 1	Input 2	1 bit	C	R	W	-
	98	Logic block 1	Input 3	1 bit	C	R	W	-
	99	Logic block 1	Input 4	1 bit	C	R	W	-
	100	Logic block 1	Logic result	1 bit	C	R	-	T
	101	Logic block 2	Authorization	1 bit	C	R	W	-
	102	Logic block 2	Input 1	1 bit	C	R	W	-
	103	Logic block 2	Input 2	1 bit	C	R	W	-
	104	Logic block 2	Input 3	1 bit	C	R	W	-
	105	Logic block 2	Input 4	1 bit	C	R	W	-
	106	Logic block 2	Logic result	1 bit	C	R	-	T
	107	Outputs 1-3	Restore ETS-params settings	1 bit	C	R	W	-
	108	Outputs 1-3	Device LED switch off	1 bit	C	R	W	-
	109	Outputs 1-3	Diagnosis	6 byte	C	R	-	T

4.1.1 Manual mode

No.	Name	Function of the object	Data type	Flags
93	Outputs 1-3	Deactivation of manual mode	1 bit - 1.001 DPT_Switch	C, R, W
<p>This object is activated if the Manual mode parameter and the Deactivation of manual mode object are active. This object is used to control the manual mode via the KNX bus. Object value: Depends on the Polarity parameter.</p> <p>0 = Manual mode locked-up, 1 = Manual mode authorized:</p> <ul style="list-style-type: none"> - If the object receives the value 1, manual mode is activated. - If the object receives the value 0, manual mode is deactivated. <p>0 = Manual mode authorized, 1 = Manual mode locked-up:</p> <ul style="list-style-type: none"> - If the object receives the value 1, manual mode is deactivated. - If the object receives the value 0, manual mode is activated. <p>For further information, see: Manual mode.</p>				

No.	Name	Function of the object	Data type	Flags
94	Outputs 1-3	Status indication manual mode	1 bit - 1.011 DPT_State	C, R, T
<p>This object is activated if the Manual mode parameter and the Object status indication manual mode are active. This object is used to send the manual mode status of the device via the KNX bus. Object value: Depends on the Polarity parameter.</p> <p>0 = Manual mode activated, 1 = Manual mode deactivated:</p> <ul style="list-style-type: none"> - If manual mode is deactivated, a telegram is sent with logic value 1. - If manual mode is activated, a telegram is sent with logic value 0. <p>0 = Manual mode deactivated, 1 = Manual mode activated:</p> <ul style="list-style-type: none"> - If manual mode is activated, a telegram is sent with logic value 1. - If manual mode is deactivated, a telegram is sent with logic value 0. <p>This object is sent periodically and/or on status change. For further information, see: Manual mode.</p>				

4.1.2 Logic block

No.	Name	Function of the object	Data type	Flags
95	Logic block 1	Authorization	1 bit - 1.003 DPT_Enable	C, R, W
<p>This object is activated if the Logic block 1 parameter and the Lock-up logic block object are active. This object makes it possible to activate or deactivate the logic blocks of the device via the KNX bus. Object value: Depends on the Polarity parameter.</p> <p>0 = Locked-up, 1 = Authorized:</p> <ul style="list-style-type: none"> - If the object receives the value 0, logic block 1 is deactivated. - If the object receives the value 1, logic block 1 is activated. <p>0 = Authorized, 1 = Locked-up:</p> <ul style="list-style-type: none"> - If the object receives the value 0, logic block 1 is activated. - If the object receives the value 1, logic block 1 is deactivated. <p>The value of this object can be initialized at start-up of the device. For further information, see: Logic block.</p>				

No.	Name	Function of the object	Data type	Flags
96	Logic block 1	Input 1	1 bit - 1.002 DPT_Bool	C, R, W
97	Logic block 1	Input 2	1 bit - 1.002 DPT_Bool	C, R, W
98	Logic block 1	Input 3	1 bit - 1.002 DPT_Bool	C, R, W
99	Logic block 1	Input 4	1 bit - 1.002 DPT_Bool	C, R, W
<p>These objects are activated in accordance with the value of the Number of logic inputs parameter. There may be up to a maximum of 4 of these objects. These objects are used to produce the status of a logic input for processing of the logic operation. The value of these objects can be initialized at start-up of the device. For further information, see: Logic block.</p>				

No.	Name	Function of the object	Data type	Flags
100	Logic block 1	Logic result	1 bit - 1.002 DPT_Bool	C, R, T
<p>This object is activated when the Logic block 1 parameter is active. This object enables output of the results of the logic operation via the bus. The value of the object is the result of a logic AND or OR operation, according to the status of the logic inputs. There may be up to a maximum of 4 of these objects. This result can also be directly assigned to the status of the output contact.</p> <p>For further information, see: Logic block.</p>				

No.	Name	Function of the object	Data type	Flags
101	Logic block 2	Authorization	1 bit - 1.003 DPT_Enable	C, R, W
See object No. 95				

No.	Name	Function of the object	Data type	Flags
102	Logic block 2	Input 1	1 bit - 1.002 DPT_Bool	C, R, W
103	Logic block 2	Input 2	1 bit - 1.002 DPT_Bool	C, R, W
104	Logic block 2	Input 3	1 bit - 1.002 DPT_Bool	C, R, W
105	Logic block 2	Input 4	1 bit - 1.002 DPT_Bool	C, R, W
See object No. 96				

No.	Name	Function of the object	Data type	Flags
106	Logic block 2	Logic result	1 bit - 1.002 DPT_Bool	C, R, T
See object No. 100				

4.1.3 Behaviour of the device

No.	Name	Function of the object	Data type	Flags
107	Outputs 1-3	Restore ETS-params settings	1 bit - 1.015 DPT_Reset	C, R, W
<p>This object is activated if the Activ. of restore ETS-parameters object (scenes, timer, setpoints) parameter is active. This object enables the current parameter value to be replaced at any time with the ETS parameter value. If the object receives value 1, then the output status values for the scenes, the timer duration specifications and all the counter setpoints are reset to the values sent by the last download.</p> <p>For further information, see: Restore ETS-Parameters.</p>				

No.	Name	Function of the object	Data type	Flags
108	Outputs 1-3	Device LED switch off	1 bit - 1.001 DPT_Switch	C, R, W
<p>This object is activated if the Device LEDS lock-up object parameter is active.</p> <p>This function is used to reduce the overall power consumption of the device. It allows the LEDs on the front of the device to be switched off.</p> <p>Object value: Depends on the Polarity parameter.</p> <p>0 = Status indication, 1 = Always OFF:</p> <ul style="list-style-type: none"> - If the object receives value 0, the LED display is activated. - If the object receives value 1, the LED display is deactivated. <p>0 = Always OFF, 1 = Status indication:</p> <ul style="list-style-type: none"> - If the object receives value 0, the LED display is deactivated. - If the object receives value 1, the LED display is activated. <p>For further information, see: LED display.</p>				

4.1.4 Diagnosis

No.	Name	Function of the object	Data type	Flags														
109	Outputs 1-3	Diagnosis	6 byte - Specific	C, R, T														
<p>This object is activated when the Device diagnosis object parameter is active.</p> <p>The object enables reporting of current faults according to the device and the application used. It also allows sending of the position of the switch on the front of the device and the number of the output that is affected by the fault(s).</p> <table border="1" data-bbox="142 1003 1445 1099"> <thead> <tr> <th>Byte number</th> <th>6 (MSB)</th> <th>5</th> <th>4</th> <th>3</th> <th>2</th> <th>1(LSB)</th> </tr> </thead> <tbody> <tr> <td>Use</td> <td>Switch position</td> <td>Application type</td> <td>Output number</td> <td colspan="3">Error codes</td> </tr> </tbody> </table> <p>This object is sent periodically and/or on status change.</p> <p>For further information, see: Diagnosis.</p>					Byte number	6 (MSB)	5	4	3	2	1(LSB)	Use	Switch position	Application type	Output number	Error codes		
Byte number	6 (MSB)	5	4	3	2	1(LSB)												
Use	Switch position	Application type	Output number	Error codes														

4.2 Output communication objects

	Number	Name	Function of the object	Length	C	R	W	T
	0	Output 1	ON/OFF	1 bit	C	R	W	-
	1	Output 1	Dimming	1 bit	C	R	W	-
	2	Output 1	Brightness value	1 byte	C	R	W	-
	3	Output 1	Load memorisation	1 bit	C	R	W	-
	4	Output 1	Default memorisation	1 bit	C	R	-	T
	5	Output 1	Timer/toggle switch changeover	1 bit	C	R	W	-
	6	Output 1	Time limited toggle switch	1 bit	C	R	W	-
	7	Output 1	Status indication ON/OFF	1 bit	C	R	-	T
	8	Output 1	Status ind. brightness value	1 byte	C	R	-	T
	9	Output 1	Timer	1 bit	C	R	W	-
	10	Output 1	Timer duration	3 byte	C	R	W	-
	11	Output 1	Scene	1 byte	C	R	W	-
	12	Output 1	Preset 1	1 bit	C	R	W	-
	13	Output 1	Preset 2	1 bit	C	R	W	-
	14	Output 1	Preset 1 authorization	1 bit	C	R	W	-
	15	Output 1	Preset 2 authorization	1 bit	C	R	W	-
	16	Output 1	Lock-up 1	1 bit	C	R	W	-
	17	Output 1	Lock-up 2	1 bit	C	R	W	-
	18	Output 1	Status indication lock-up	1 bit	C	R	-	T
	19	Output 1	Priority	2 bit	C	R	W	-
	20	Output 1	Status indication priority	1 bit	C	R	-	T
	21	Output 1	Hours counter value	2 byte	C	R	-	T
	22	Output 1	Reset hours counter value	1 bit	C	R	W	-
	23	Output 1	Hours counter setpoint reached	1 bit	C	R	-	T
	24	Output 1	Hours counter setpoint	2 byte	C	R	W	-
	25	Output 1	Dimming mode	1 bit	C	R	-	T
	26	Output 1	Overload	1 bit	C	R	-	T
	27	Output 1	Short circuit	1 bit	C	R	-	T
	28	Output 1	Over voltage	1 bit	C	R	-	T
	29	Output 1	Over temperature	1 bit	C	R	-	T
	30	Output 1	Load default	1 bit	C	R	-	T

	Number	Name	Function of the object	Length	C	R	W	T
	31	Output 2	ON/OFF	1 bit	C	R	W	-
	32	Output 2	Dimming	1 bit	C	R	W	-
	33	Output 2	Brightness value	1 byte	C	R	W	-
	34	Output 2	Load memorisation	1 bit	C	R	W	-
	35	Output 2	Default memorisation	1 bit	C	R	-	T
	36	Output 2	Timer/toggle switch changeover	1 bit	C	R	W	-
	37	Output 2	Time limited toggle switch	1 bit	C	R	W	-
	38	Output 2	Status indication ON/OFF	1 bit	C	R	-	T
	39	Output 2	Status ind. brightness value	1 byte	C	R	-	T
	40	Output 2	Timer	1 bit	C	R	W	-
	41	Output 2	Timer duration	3 byte	C	R	W	-
	42	Output 2	Scene	1 byte	C	R	W	-
	43	Output 2	Preset 1	1 bit	C	R	W	-
	44	Output 2	Preset 2	1 bit	C	R	W	-
	45	Output 2	Preset 1 authorization	1 bit	C	R	W	-
	46	Output 2	Preset 2 authorization	1 bit	C	R	W	-
	47	Output 2	Lock-up 1	1 bit	C	R	W	-
	48	Output 2	Lock-up 2	1 bit	C	R	W	-
	49	Output 2	Status indication lock-up	1 bit	C	R	-	T
	50	Output 2	Priority	2 bit	C	R	W	-
	51	Output 2	Status indication priority	1 bit	C	R	-	T
	52	Output 2	Hours counter value	2 byte	C	R	-	T
	53	Output 2	Reset hours counter value	1 bit	C	R	W	-
	54	Output 2	Hours counter setpoint reached	1 bit	C	R	-	T
	55	Output 2	Hours counter setpoint	2 byte	C	R	W	-
	56	Output 2	Dimming mode	1 bit	C	R	-	T
	57	Output 2	Overload	1 bit	C	R	-	T
	58	Output 2	Short circuit	1 bit	C	R	-	T
	59	Output 2	Over voltage	1 bit	C	R	-	T
	60	Output 2	Over temperature	1 bit	C	R	-	T
	61	Output 2	Load default	1 bit	C	R	-	T

	Number	Name	Function of the object	Length	C	R	W	T
	62	Output 3	ON/OFF	1 bit	C	R	W	-
	63	Output 3	Dimming	1 bit	C	R	W	-
	64	Output 3	Brightness value	1 byte	C	R	W	-
	65	Output 3	Load memorisation	1 bit	C	R	W	-
	66	Output 3	Default memorisation	1 bit	C	R	-	T
	67	Output 3	Timer/toggle switch changeover	1 bit	C	R	W	-
	68	Output 3	Time limited toggle switch	1 bit	C	R	W	-
	69	Output 3	Status indication ON/OFF	1 bit	C	R	-	T
	70	Output 3	Status ind. brightness value	1 byte	C	R	-	T
	71	Output 3	Timer	1 bit	C	R	W	-
	72	Output 3	Timer duration	3 byte	C	R	W	-
	73	Output 3	Scene	1 byte	C	R	W	-
	74	Output 3	Preset 1	1 bit	C	R	W	-
	75	Output 3	Preset 2	1 bit	C	R	W	-
	76	Output 3	Preset 1 authorization	1 bit	C	R	W	-
	77	Output 3	Preset 2 authorization	1 bit	C	R	W	-
	78	Output 3	Lock-up 1	1 bit	C	R	W	-
	79	Output 3	Lock-up 2	1 bit	C	R	W	-
	80	Output 3	Status indication lock-up	1 bit	C	R	-	T
	81	Output 3	Priority	2 bit	C	R	W	-
	82	Output 3	Status indication priority	1 bit	C	R	-	T
	83	Output 3	Hours counter value	2 byte	C	R	-	T
	84	Output 3	Reset hours counter value	1 bit	C	R	W	-
	85	Output 3	Hours counter setpoint reached	1 bit	C	R	-	T
	86	Output 3	Hours counter setpoint	2 byte	C	R	W	-
	87	Output 3	Dimming mode	1 bit	C	R	-	T
	88	Output 3	Overload	1 bit	C	R	-	T
	89	Output 3	Short circuit	1 bit	C	R	-	T
	90	Output 3	Over voltage	1 bit	C	R	-	T
	91	Output 3	Over temperature	1 bit	C	R	-	T
	92	Output 3	Load default	1 bit	C	R	-	T

4.2.1 ON/OFF

No.	Name	Function of the object	Data type	Flags
0, 31, 62	Output x	ON/OFF	1 bit - 1.001 DPT_Switch	C, R, W

These objects are always activated. They enable switching of the output contact in accordance with the value that is sent via the KNX bus.

Object value: Object value: depends on the **Output contact** parameter.

Normally open:

- On input of an OFF command, the output relay contact opens.
- On input of an ON command, the output relay contact closes.

Normally closed:

- On input of an OFF command, the output relay contact closes.
- On input of an ON command, the output relay contact opens.

For further information, see: [Definition](#).

4.2.2 Dimming

No.	Name	Function of the object	Data type	Flags
1, 32, 63	Output x	Dimming	4 bit - 3.007 DPT_DPT_Control_Dimming	C, R, W

These objects are always activated. They enable relative dimming of the output in accordance with the value that is sent on the KNX bus.

The output is dimmed in accordance with the 4-bit format value that arrives.

Object value:

b3	b2	b1	b0
C	Steps		

Data fields	Description	Code
C	Increase or reduction in brightness	0: Decrease 1: Increase
Steps	Brightness between 0% and 100% divided into steps	0: Stop 1: 100% 2: 50% 3: 25% 4: 12% 5: 6% 6: 3% 7: 1%

For further information, see: [Definition](#).

No.	Name	Function of the object	Data type	Flags
2, 33, 64	Output x	Brightness value	1 byte - 5.001 DPT_Scaling	C, R, W
<p>These objects are always activated. They enable absolute dimming of the output in accordance with the value that is sent on the KNX bus.</p> <p>The output is dimmed according to the value that arrives in 1-byte format and corresponds in % to the brightness value to be attained.</p> <p>Object value: 0 to 255: 0 = 0%, 255 = 100%</p> <p>Resolution: Approx. 0.4%</p> <p>For further information, see: Definition.</p>				

4.2.3 Load memorisation

No.	Name	Function of the object	Data type	Flags
3, 34, 65	Output x	Load memorisation	1 bit - 1.003 DPT_Enable	C, R, W
<p>These objects are always activated. They are used to start the memorisation process in accordance with the value that is sent on the KNX bus.</p> <p>This process lasts around 30 seconds and results in varying brightness.</p> <p>After the memorisation, the load is activated on the highest step and blinks once, to report that the learning is completed.</p> <p>If the object receives the value 1, the Load memorisation is started.</p> <p>For further information, see: Definition.</p>				

No.	Name	Function of the object	Data type	Flags
4, 35, 66	Output x	Default memorisation	1 bit - 1.005 DPT_Alarm	C, R, T
<p>These objects are always activated. They are used for notification of a default memorisation.</p> <p>If the load is not recognised at the end of the learning process, the device automatically selects the Factory setting for the dimming mode.</p> <p>If learning of the load has failed, a telegram with logic value 1 is sent to the object.</p> <p>For further information, see: Definition.</p>				

4.2.4 ON/OFF timings function

No.	Name	Function of the object	Data type	Flags
5, 36, 67	Output x	Timer/toggle switch changeover	1 bit - 1.001 DPT_Switch	C, R, W
<p>This object is activated if the Timer/toggle switch changeover for ON/OFF object parameter is active.</p> <p>This object is used to switch between a toggle switch and timer switch operation on the same pushbutton.</p> <ul style="list-style-type: none"> - If the Timer/toggle switch changeover object receives the value 1, the Toggle-switch mode function is activated. The ON/OFF switching of the output is performed as usual via the ON/OFF object. - If the Timer/toggle switch changeover object receives the value 0, the Timer mode function is activated. <ul style="list-style-type: none"> - If the ON/OFF object receives the value 1, the output is switched ON. After expiry of a configurable time, the output is automatically switched OFF. - If the ON/OFF object receives the value 0, the output is switched OFF. <p><i>Example: Switching function daytime and Time-limited OFF function at night. During the day, the button is used as a switch. In the evenings, the button is used as a time-limited OFF switch, so that the light will turn off automatically.</i></p> <p>For further information, see: ON/OFF timings function.</p>				

No.	Name	Function of the object	Data type	Flags
6, 37, 68, 98, 130, 162	Output x	Time limited toggle switch object	1 bit - 1.001 DPT_Switch	C, R, W
<p>This object is activated when the Additional time limited toggle switch function parameter is active.</p> <p>This object combines a timer function with a tripping Delay function.</p> <ul style="list-style-type: none"> - If the object receives the value 1, the output switches to ON for a configurable time period. After that period expires, the output switches to OFF. - If the object receives the value 0, the output switches to OFF. <p><i>Note: The time-limited OFF function is generally used for lighting in cellars, attics and sheds.</i></p> <p>For further information, see: ON/OFF timings function.</p>				

4.2.5 Status indication

No.	Name	Function of the object	Data type	Flags
7, 38, 69	Output x	Status indication ON/OFF	1 bit - 1.001 DPT_Switch	C, R, T
<p>This object is activated when the Status indication ON/OFF parameter is active. This object allows the status of the output contact to be sent from the device over the KNX bus. Object value: Depends on the Polarity parameter.</p> <p>0 = ON, 1 = OFF</p> <ul style="list-style-type: none"> - If the output relay is open, a telegram with logic value 1 is sent on the KNX bus. - If the output relay is closed, a telegram with logic value 0 is sent on the KNX bus. <p>0 = OFF, 1 = ON</p> <ul style="list-style-type: none"> - If the output relay is open, a telegram with logic value 0 is sent on the KNX bus. - If the output relay is closed, a telegram with logic value 1 is sent on the KNX bus. <p>This object is sent periodically and/or on status change.</p> <p>For further information, see: Status indication.</p>				

No.	Name	Function of the object	Data type	Flags
8, 39, 70	Output x	Status ind. brightness value	1 byte - 5.001 DPT_Scaling	C, R, T
<p>This object is activated when the Status ind. brightness value parameter is active. This object allows the status of the brightness value of the Output to be sent over the KNX bus. Object value: 0 to 255: 0 = 0%, 255 = 100%</p> <p>For further information, see: Status indication.</p>				

4.2.6 Timer

No.	Name	Function of the object	Data type	Flags
9, 40, 71	Output x	Timer	1 bit - 1.001 DPT_Switch	C, R, W
<p>This object is activated when the Timer parameter is active. This object is used to activate the Timer function of the device via the KNX bus. Object value:</p> <ul style="list-style-type: none"> - If a rising edge (0 to 1) arrives at this object, the output switches for a configurable period. - If a falling edge (1 to 0) arrives at this object, the output remains in its current state. <p><i>Note: Depending on the configuration, the timer switching can be interrupted on the timer by a long press of the control button.</i> <i>Note: Depending on the configuration, the timer duration may be reset by input of a start command during timer operation.</i></p> <p>For further information, see: Timer.</p>				

No.	Name	Function of the object	Data type	Flags
10, 41, 72	Output x	Timer duration	3 byte - 10.001 DPT_TimeOfDay	C, R, W

This object is activated if the **Timer duration modifiable through object** object parameter is active.
 This object can be used to configure the timer duration. The timer duration can thus be configured in accordance with a time of day.

Byte 3 (MSB)							Byte 2							Byte 1 (LSB)									
			Hours						Minutes							Seconds							
0	0	0	H	H	H	H	H	0	0	M	M	M	M	M	M	0	0	S	S	S	S	S	S

Fields	Code	Value	Units
Hours	Binary	0 to 23 (5 bit)	Hours
Minutes	Binary	0 to 59 (6 bit)	Minutes
Seconds	Binary	0 to 59 (6 bit)	Seconds

For further information, see: [Timer](#).

4.2.7 Scene

No.	Name	Function of the object	Data type	Flags
11, 42, 73	Output x	Scene	1 byte - 17.001 DPT_SceneNumber	C, R, W

This object is activated when the **Scene** parameter is active.
 This object is used to recall or save a scene.
 Details on the format of the object are given below.

7	6	5	4	3	2	1	0
Learning	Not used	Scene number					

Bit 7: 0: The scene is called / 1: The scene is saved.
 Bit 6: Not used.
 Bit 5 to Bit 0: Scene numbers from 0 (Scene 1) to 63 (Scene 64).

For further information, see: [Scene](#).

4.2.8 Preset

No.	Name	Function of the object	Data type	Flags
12, 43, 74	Output x	Preset 1	1 bit - 1.022 DPT_Scene_AB	C, R, W
<p>This object is activated if the Preset has value Active with preset 1-level object or Active with preset 2-level objects. With this object, several outputs can be set to a configurable predefined status. Object value: - If the object receives value 0, the values of the parameters for Preset 1 = 0 are used. - If the object receives value 1, the values of the parameters for Preset 1 = 1 are used.</p> <p>For further information, see: Preset.</p>				

No.	Name	Function of the object	Data type	Flags
13, 44, 75	Output x	Preset 2	1 bit - 1.022 DPT_Scene_AB	C, R, W
<p>This object is activated if the Preset parameter has value Active with preset 2-level objects.</p> <p>See object No. 12</p>				

No.	Name	Function of the object	Data type	Flags
14, 45, 76	Output x	Preset 1 authorization	1 bit - 1.003 DPT_Enable	C, R, W
<p>This object is activated if the Preset authorization objects parameter is active. This object allows the authorization or lock-up of the Preset 1 function via a KNX telegram. Object value: This is dependent on the Polarity of autorisation object Preset 1 parameter. 0 = Locked-up, 1 = Authorized: - If the object receives the value 0, Preset 1 is deactivated. - If the object receives the value 1, Preset 1 is activated.</p> <p>0 = Authorized, 1 = Locked-up: - If the object receives the value 0, Preset 1 is activated. - If the object receives the value 1, Preset 1 is deactivated.</p> <p>For further information, see: Preset.</p>				

No.	Name	Function of the object	Data type	Flags
10, 42, 74, 106, 138, 170	Output x	Preset 2 authorization	1 bit - 1.003 DPT_Enable	C, R, W
<p>See object No. 14</p>				

4.2.9 Lock-up

No.	Name	Function of the object	Data type	Flags
16, 47, 78	Output x	Lock-up 1	1 bit - 1.003 DPT_Enable	C, R, W
<p>This object is activated if the Lock-up has value Active with 1 lock-up object or Active with 2 lock-up objects. This object is used to control the activation of the lock-up via the KNX bus. Object value: This is dependent on the Polarity of lock-up object 1 parameter. 0 = Lock-up activated, 1 = Lock-up deactivated:</p> <ul style="list-style-type: none"> - If the object receives value 0, the Lock-up is activated. - If the object receives value 1, the Lock-up is deactivated. <p>0 = Lock-up deactivated, 1 = Lock-up activated:</p> <ul style="list-style-type: none"> - If the object receives value 0, the Lock-up is deactivated. - If the object receives value 1, the Lock-up is activated. <p>For further information, see: Lock-up.</p>				

No.	Name	Function of the object	Data type	Flags
17, 48, 79	Output x	Lock-up 2	1 bit - 1.003 DPT_Enable	C, R, W
<p>This object is activated if the Lock-up parameter has value Active with 2 lock-up objects.</p> <p>See object No. 16.</p>				

No.	Name	Function of the object	Data type	Flags
18, 49, 80	Output x	Status indication lock-up	1 bit - 1.011 DPT_State	C, R, T
<p>This object is activated when the Activation of lock-up status object parameter is active. This object allows the status of the lock-up to be sent from the device over the KNX bus. Object value: Depends on the Polarity parameter. 0 = Lock-up deactivated, 1 = Lock-up activated:</p> <ul style="list-style-type: none"> - If the lock-up is deactivated, a telegram with logic value 0 is sent on the KNX bus. - If the lock-up is activated, a telegram with logic value 1 is sent on the KNX bus. <p>0 = Lock-up activated, 1 = Lock-up deactivated:</p> <ul style="list-style-type: none"> - If the lock-up is activated, a telegram with logic value 0 is sent on the KNX bus. - If the lock-up is deactivated, a telegram with logic value 1 is sent on the KNX bus. <p>This object is sent periodically and/or on status change. For further information, see: Lock-up.</p>				

4.2.10 Priority

No.	Name	Function of the object	Data type	Flags
19, 50, 81	Output x	Priority	2 bit - 2.002 DPT_Bool_Control	C, R, W

This object is activated if the **Priority** parameter is active.
 The status of the output contact is determined directly by this object.
 Details on the format of the object are given below.

Telegram received by the priority operation object		Status of the outputs
Bit 1	Bit 2	
0	0	End of the priority
0	1	End of the priority
1	0	Priority OFF
1	1	Priority ON

The first bit of this object (Bit 0) determines the status of the output contact, which should be priority controlled. The second bit activates or deactivates the Priority.

For further information, see: [Priority](#).

No.	Name	Function of the object	Data type	Flags
20, 51, 82	Output x	Status indication priority	1 bit - 1.011 DPT_State	C, R, T

This object is activated if the **Activation of priority status object** parameter is active.
 This object allows the status of the Priority to be sent from the device on the KNX bus.
 Object value: Depends on the **Polarity** parameter.

0 = Not forced, 1 = Forced:

- If Priority is deactivated, a telegram is sent with logic value 0.
- If Priority is activated, a telegram is sent with logic value 1.

0 = Forced, 1 = Not forced:

- If Priority is activated, a telegram is sent with logic value 0.
- If Priority is deactivated, a telegram is sent with logic value 1.

This object is sent periodically and/or on status change.

For further information, see: [Priority](#).

4.2.11 Hours counter

No.	Name	Function of the object	Data type	Flags
21, 52, 83	Output x	Hours counter value	2 byte - 7.001 DPT_16_bit_Counter	C, R, T

This object is activated when the **Hours counter** parameter is active.
 This object allows the value of the operating hours to be sent from the device on the KNX bus.
 The count value is saved during a power cut on the KNX bus. It is submitted after return of power to the bus or after an ETS download.
 Object value: 0 to 65535 hours.

This object is sent periodically and/or on status change.
 For further information, see: [Hours counter](#).

No.	Name	Function of the object	Data type	Flags
22, 53, 84	Output x	Reset hours counter value	1 bit - 1.015 DPT_Reset	C, R, W

This object is activated when the **Hours counter** parameter is active.
 This object enables the hours counter value to be reset.
 Object value:

- If the object receives the value 0, the counter is not reset.
- If the object receives the value 1, the counter is reset.

For further information, see: [Hours counter](#).

No.	Name	Function of the object	Data type	Flags
23, 54, 85	Output x	Hours counter setpoint reached	1 bit - 1.002 DPT_Bool	C, R, T

This object is activated when the **Hours counter** parameter is active.
 This object reports that the hours counter has reached its setpoint.

- Incrementing counter: Counter = Counter value setpoint.
- Countdown counter: Counter = 0.

Object value: If the setpoint is reached, a telegram with logic value 1 is sent on the KNX bus.
 The count value is saved during a power cut on the KNX bus. It is submitted after return of power to the bus or after an ETS download.

This object is sent periodically and/or on status change.
 For further information, see: [Hours counter](#).

No.	Name	Function of the object	Data type	Flags
24, 55, 86	Output x	Counter value setpoint	2 byte - 7.001 DPT_16_bit_Counter	C, R, W

This object is activated if the **Counter setpoint value modifiable through object** object parameter is active. This object is used to initialize the counter setpoint of the hours counter via the KNX bus.
 Object value: 0 to 65535 hours.

This object is sent periodically and/or on status change.
 For further information, see: [Hours counter](#).

4.2.12 Notifications

No.	Name	Function of the object	Data type	Flags
26, 57, 88	Output x	Overload	1 bit - 1.005 DPT_Alarm	C, R, T

This object is activated when the **Overload** parameter is active.
 This object is used for notification of an overload on the output concerned, via the KNX bus. An overload arises, for example, when several lamps are connected to the output, exceeding its rated power.
 Object value: If an overload is detected on the output concerned, a telegram with logic value 1 is sent to the object.

This object is sent periodically and/or on status change.
 For further information, see: [Notifications](#).

No.	Name	Function of the object	Data type	Flags
27, 58, 89	Output x	Short circuit	1 bit - 1.005 DPT_Alarm	C, R, T

This object is activated when the **Short circuit** parameter is active.
 This object is used for notification of a short circuit on the output concerned, via the KNX bus.
 Object value: If a short circuit is detected on the output concerned, a telegram with logic value 1 is sent to the object.

This object is sent periodically and/or on status change.
 For further information, see: [Notifications](#).

No.	Name	Function of the object	Data type	Flags
28, 59, 90	Output x	Over voltage	1 bit - 1.005 DPT_Alarm	C, R, T

This object is activated when the **Over voltage** parameter is active.
 This object is used for notification of an over voltage on the output concerned, via the KNX bus.
 Object value: If an over voltage is detected on the output concerned, a telegram with logic value 1 is sent to the object.

This object is sent periodically and/or on status change.
 For further information, see: [Notifications](#).

No.	Name	Function of the object	Data type	Flags
29, 60, 91	Output x	Over temperature	1 bit - 1.005 DPT_Alarm	C, R, T

This object is activated when the **Over temperature** parameter is active.
 This object is used for notification of an over temperature on the output concerned, via the KNX bus. An over temperature arises when a load is connected to the output that results in a temperature increase in the output current circuit.
 Object value: If an overload is detected on the output concerned, a telegram with logic value 1 is sent to the object.

This object is sent periodically and/or on status change.
 For further information, see: [Notifications](#).

No.	Name	Function of the object	Data type	Flags
30, 61, 92	Output x	Load default	1 bit - 1.005 DPT_Alarm	C, R, T
<p>This object is activated if the Load default parameter is active.</p> <p>This object is used for notification of a load default on the output concerned, via the KNX bus. Load default means that the output has no load or a defective load.</p> <p>Object value: If a load default is detected on the output concerned, a telegram with logic value 1 is sent to the object.</p> <p>This object is sent periodically and/or on status change.</p> <p>For further information, see: Notifications.</p>				

5. Appendix

5.1 Specifications

5.1.1 TYA661A/B

Supply voltage	30 V DC SELV 230 V ~ 50/60 Hz
Busline max consumption	2,3 mA
Zero-load mains consumption	350 mW
Power dissipation	4 W (TYA661A) 7,5 W (TYA661B)
Dimensions	4 x 17,5 mm
Protection class	IP 30
Operating temperature	-5 °C → + 45 °C
Storage temperature	- 25 °C → + 70 °C
Electrical connection	 0,75 mm ² → 2,5 mm ²
Installation mode	Din-rail
Operating altitude	< 2000 m
Pollution level	2
Surge voltage	4kV
Protection rating	IP 20 (housing) / IP30 (housing under faceplate)
IK	04
Overvoltage category	III
Standard	EN 60669-2-1, EN 50491-3, EN 50428

Load type	TYA661A	TYA661B
Incandescent, halogen 230V	300 W	600 W
Halogen ELV (12 or 24V) via ferromagnetic transformer suitable for dimming. The transformer shouldn't be used with less than 75 % of its nominal load.	300 VA	600 VA
Halogen ELV (12 or 24V) via electronic transformer.	300 W	600 W
Dimmable fluocompact lamps	60 W	120 W
Dimmable LED lamps	60 W (8 lampes/lamps)	120 W (10 lampes/lamps)

5.1.2 TYA663A

Supply voltage	30 V DC
	230 V~ 50/60 Hz
Busline max consumption	2,3 mA
Consumption without load	600 mW
Power dissipation	8,9 W
Dimensions	6 x 17,5 mm
Protection class	IP20/ IP30 faceplate in place
Operating temperature	-5 °C → + 45 °C
Storage temperature	-20 °C → + 70 °C
Norms	EN 60669-2-1, EN 50491-3, EN 50428
Electrical connection	→ 0,75 mm ² → 2,5 mm ²

Type de charges / Load type				
Incandescent, halogen 230V	C1 C2 C3	1x 900 W - -	1x 600 W 1x 300 W -	1x 300 W 1x 300 W 1x 300 W
Halogen ELV (12 or 24V) via ferromagnetic transformer suitable for dimming. The transformer shouldn't be used with less than 75 % of its nominal load.	C1 C2 C3	1x 900 W - -	1x 600 W 1x 300 W -	1x 300 W 1x 300 W 1x 300 W
Halogen ELV (12 or 24V) via electronic transformer.	C1 C2 C3	1x 900 W - -	1x 600 W 1x 300 W -	1x 300 W 1x 300 W 1x 300 W
Dimmable fluocompact lamps	C1 C2 C3	1x 210 W - -	1x 120 W 1x 60 W -	1x 60 W 1x 60 W 1x 60 W
Dimmable LED lamps	C1 C2 C3	210 W - (15 lampes/ lamps)	1x 120 W 1x 60 W - (8 et/and 15 lampes/lamps)	1x 60 W 1x 60 W 1x 60 W 8 lampes/lamps/ sortie/output

5.1.3 TYA664A

Supply voltage via mains	230 V AC, + 10 % .. - 15 % 240 V AC, + 6 % .. - 6%
Supply voltage KNX/EIB	DC 21...32 V TBTS
Current consumption KNX/EIB	2,3 mA
Consumption without load	600 mW
Operating altitude max	2000 m.
Pollution degree	2
Power dissipation per output	2 W
Surge voltage	4 kV
Degree of protection of housing	IP 20
Degree of protection of housing under front panel	IP30
IK (impact protection)	4
Overvoltage class	III
Dimension	8 TE, 8 x 17,5 mm
Connection capacity	0,75 mm ² ...2,5 mm ²
Operating temperature	-5 ...+45 °C
Storage temperature	- 20 ...+ 70 °C
Standards	EN50491-3 EN60669-2-1 EN50428
Load that can be connected per output	
230 V incandescent lamps, halogen lamps	300 W
12 V / 24 V halogen lamps with conventional transformer	300 VA
12 V / 24 V halogen lamps with electronic transformer	300 W
Dimmable energy-saving lamps (CFL)/LED lamps (max. of lamps)	60 W (8)

5.2 Table of logical operations

Input 4	Input 3	Input 2	Input 1	OR	AND
-	-	0	0	0	0
-	-	0	1	1	0
-	-	1	0	1	0
-	-	1	1	1	1
-	0	0	0	0	0
-	0	0	1	1	0
-	0	1	0	1	0
-	0	1	1	1	0
-	1	0	0	1	0
-	1	0	1	1	0
-	1	1	0	1	0
-	1	1	1	1	1
0	0	0	0	0	0
0	0	0	1	1	0
0	0	1	0	1	0
0	0	1	1	1	0
0	1	0	0	1	0
0	1	0	1	1	0
0	1	1	0	1	0
0	1	1	1	1	0
1	0	0	0	1	0
1	0	0	1	1	0
1	0	1	0	1	0
1	0	1	1	1	0
1	1	0	0	1	0
1	1	0	1	1	0
1	1	1	0	1	0
1	1	1	1	1	1

5.3 Characteristics

Device	TYA661	TYA663	TYA664
Max. number of group addresses	254	254	254
Max. number of allocations	255	255	255
Objects	48	109	141

