







- ▲ Manufacturers
- ▲ Berker
- ▲ Physical sensors
- Presence detectors

application software

S75241003 Presence detector with relay

	Product reference	Product designation	TP device  RF devices 
	7524 10 03	Presence detector with relay	

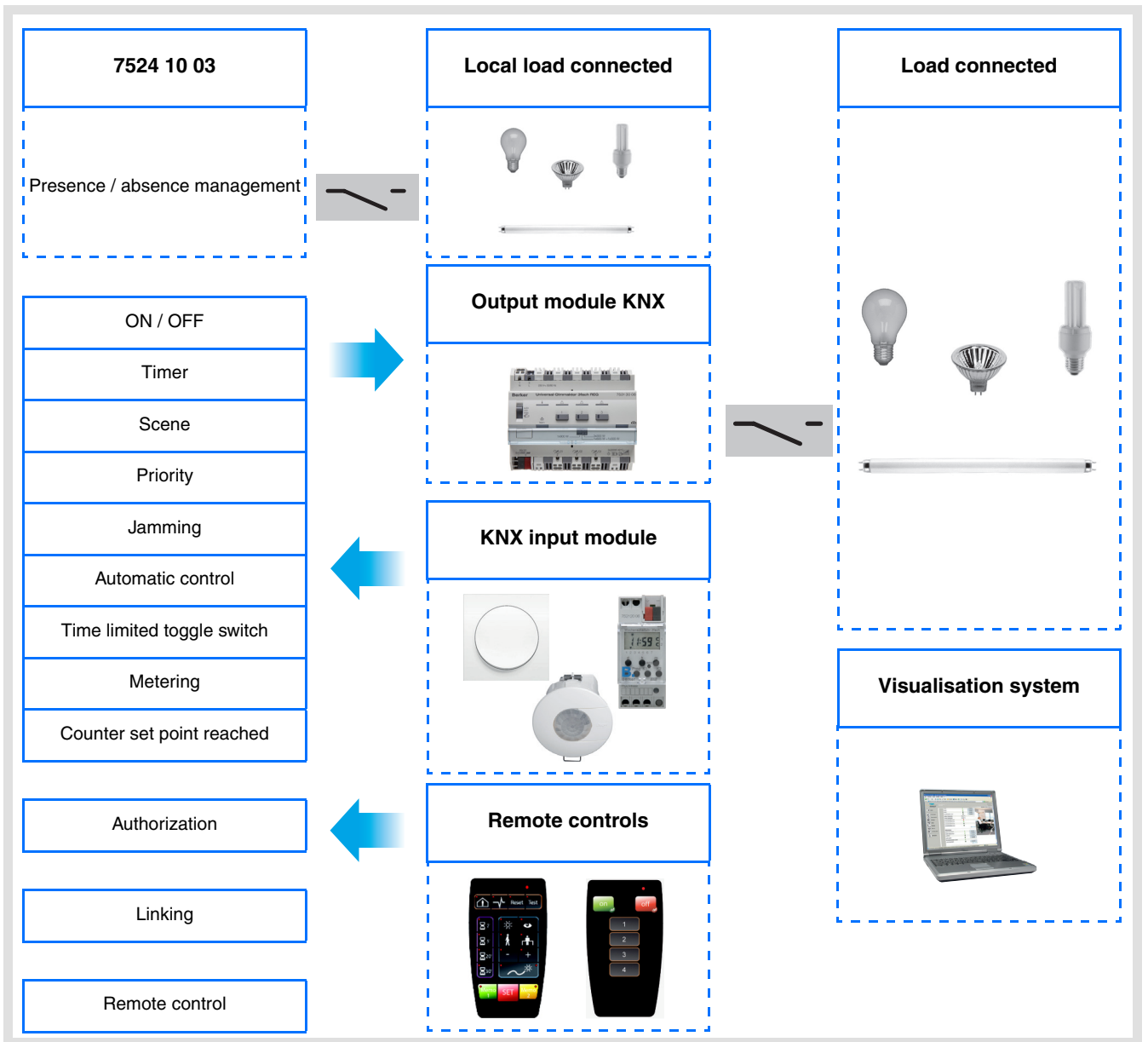

Summary

1. Function Description	3
2. Configuration and General parameters.....	5
2.1 Objects List.....	5
2.2 General parameters.....	5
2.2.1 Relay output control and scene recreation.....	5
2.2.2 Presence channels 1 and 2.....	6
2.2.3 Status at bus return when switched via detector.....	7
2.2.4 Setup IR remote control	7
2.2.5 Linking Master / Slave.....	8
3. Configuration and parameters of the lighting channel	9
3.1 Objects List.....	9
3.2 Value of the brightness threshold	10
3.3 Time delay	10
3.4 Override operation.....	10
3.5 Light cell use.....	12
3.6 Lighting channel functions.....	12
3.6.1 Function ON / OFF.....	12
3.6.2 Timer function	13
3.6.3 Brightness value and Brightness value in case of Presence / Absence functions	14
3.6.4 Scene and Scene Presence / Absence functions	15
3.6.5 Actions in the case of Authorisation = ON and Lighting channel = OFF.....	16
3.6.6 Emission after initialization.....	17
4. Configuration and parametering of the integrated relay output: Control by the KNX.....	18
4.1 Main functions overview	18
4.2 Objects List.....	20
4.3 Function Description.....	20
4.3.1 ON / OFF functions and Status indication.....	20
4.3.2 Timer functions.....	20
4.3.3 Time limited toggle switch function	22
4.3.4 Priority function	23
4.3.5 Jamming function	24
4.3.6 Scene function	26
4.3.7 Timer and Automatic controls	28
4.3.8 Metering (Working duration counter).....	33
5. Configuration of Presence Channels 1 and 2	34
5.1 Objects List.....	34
5.2 Value in %	35
5.3 Lighting function	36
5.4 Timer function.....	36
5.5 Scene function.....	36
5.6 Shutter/Blind function	37
5.7 Priority function.....	37
5.8 Heating function.....	37
5.9 Heating Activation function	38
5.10 Time delay	38
5.11 Emission time delay.....	38
5.12 Surveillance sensitivity	39
5.13 Emission after initialization	39
6. Physical addressing	40
7. Main characteristics	41
8. Appendix.....	41

1. Function Description

The software application is used to configure the presence detector.

The 7524 10 03 is a presence detector which detects the slightest movement (e.g. that of a person working in an office). A pyroelectric sensor located under the detection lens is used for detection. The presence sensor constantly measures the brightness in the room and compares it to the brightness level setting.

The brightness level can be set either with an installer remote control or with the ETS or a rotating potentiometer on the device. According to the settings, different reactions may occur on the KNX bus and the local control output depending on the measured brightness and presence.

The main functions are the following:

■ Presence detection and brightness measurement

The presence detector includes a relay output. This output is triggered if a presence is detected and if the ambient brightness is lower than an adjustable threshold value.

■ Output control by the KNX bus (lighting channel)

In addition to the local control output, the detector can control a lighting output by the KNX bus. The output can be controlled in different ways.

The possible functions are:

- Timer activation,
- Brightness value (%) presence,
- Brightness value (%) presence and absence,
- Activation of the presence scene,
- Activation of the presence and absence scene.

■ Brightness measurement

The ambient brightness level value can be set by ETS, the installer remote control or directly on the presence detector using a rotating potentiometer. This threshold value will be used to determine from which ambient brightness (darkness) a message will be sent by the **lighting channel** object on the bus in case of movement and the local output will be activated.

■ Time delay

The time delay is started when switching from presence to absence (no presence) taking into account the ambient brightness. Once the time delay has expired, the movement detector switches to absent mode (no presence). If the brightness level is sufficient, the time delay may be reduced. According to the function selected, a telegram is sent on the bus in case of Presence or of Presence and Absence. The time delay can be set by ETS, an installer remote control or via a setting potentiometer directly on the product.

■ Remote control of the Lighting channel

The remote control is used to trigger the presence detector via the KNX bus or a user remote control (e.g. start it).

The detector can be used in automatic or semi-automatic mode. When semi-automatic mode is selected, the remote control is used for activation (presence), whereas the detector controls deactivation (e.g. switches OFF).

Automatic mode is used to obtain an automatic action according to presence and the brightness conditions (e.g. ON or OFF). Here, the remote control is used to switch from presence mode (e.g. switch on the lights) to absence mode (e.g. switch off the lights).

■ Infrared remote control using the user remote control

The occupancy sensor embeds an infra red receiver. The infra red remote control offers the same functionalities as the KNX push button input (**Remote control** object).

■ Infrared settings adjustment using the installer remote control

Some settings (Remote control, Control type: automatic/semi-automatic, ambient brightness threshold value, Lighting time delay) are possible with the installer remote control. The possibility of using the remote control to adjust settings can be defined or locked by the ETS.

■ Authorization

The presence detector can be locked or unlocked thanks to authorisation (e.g. with a clock at specific times). If presence detection is deactivated, no control will be sent on the bus by the **lighting channel** object and the relay output will only be activated by the KNX bus.

■ Linking Master / Slave (Aera Linking)

This function extends the presence detector's detection zone by combining it with other detectors.

Two different relations are possible for this purpose:

- Master
The detector operates in its own detection zone according to presence and the level of light,
- Slave
The detector operates in its own detection zone according to presence and transmits the presence information to a master,
- Master / Slave
According to the brightness and presence, the detector activates its own detection area and can take into account up to 25 others. Moreover, it transmits the presence information for its own detection area to the master detector, taking into account the ambient brightness.

Operation of the presence detector is defined by an ETS parameter.

■ Relay output control

The integrated relay output can be controlled by the presence detector or in addition directly by the KNX bus. When the output is controlled by the KNX bus, it can also be controlled by the presence function if this is authorised (unlocked).

When the output is controlled by the bus, the relay output can be controlled by the usual functionality on our control outputs.

The possible functions are:

- ON / OFF
- Timer
- Time limited toggle switch
- Priority
- Jamming
- Scene
- Timer and Automatic controls
- Working duration counter

■ Surveillance channel 1 and 2

In addition to the lighting control channel, the detector can also activate a control linked just to presence or absence. Luminosity is not taken into account for these 2 channels. These channels are used to control the ventilation or heating circuits according to the presence of people in the rooms.

2. Configuration and General parameters

2.1 Objects List

N°	Name	Function of the object	Length	C	R	W	T
6	Lighting channel	Authorization	1 bit	C	R	W	-
7	Lighting channel	Remote control	1 bit	C	R	W	-
23 - 47	Slave input 1 to 25	Linking	1 bit	C	R	W	-
48	Output	Linking	1 bit	C	R	-	T

2.2 General parameters

The main settings of the presence detector operating mode can be configured in the Common settings area.

→ Parameter Setting screen

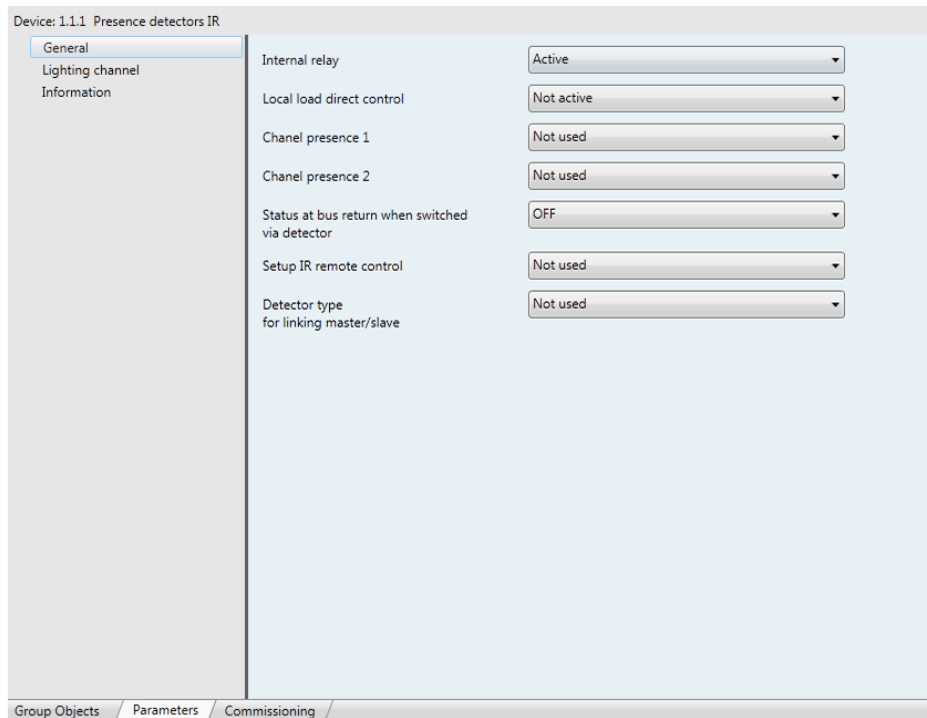

Screen 1

2.2.1 Relay output control and scene recreation

The integrated relay output can be activated according to presence or in addition, directly by the KNX bus. The relay output is controlled directly by the presence detector and can also be controlled by the KNX bus. If control by the presence function is not desirable, it can be deactivated **completely** by the Authorisation function.

If control by the KNX is unlocked (activated), the usual functions of our control outputs are possible for the relay (ON / OFF, Timer, Time limited toggle switch, Priority, Jamming, Scene, Timer and Automatic controls, Working duration counter).

Designation	Description	Value
Local load direct control	This parameter is used to determine if the relay output of the presence detector can be directly activated by the KNX bus. Control of the relay output by the bus is particularly useful for central control of the output.	Active, Not active Default value: Not active
Scenes restore object*	If the value is Active, when a 1 is received on the Output 1 - Basic scene setting object, the output statuses predefined in ETS will be re-established by all the scenes.	Not active, Active Default value: Not active

* This parameter is only visible if the **Direct control of the relay output by KNX** parameter has the following value: Active.

The following presentation shows the most important communication channels:

- Control of the integrated relay and activation of the KNX players depending on presence and absence,
- Direct control of the integrated relay by KNX control (keys, sensors, timers, etc.).

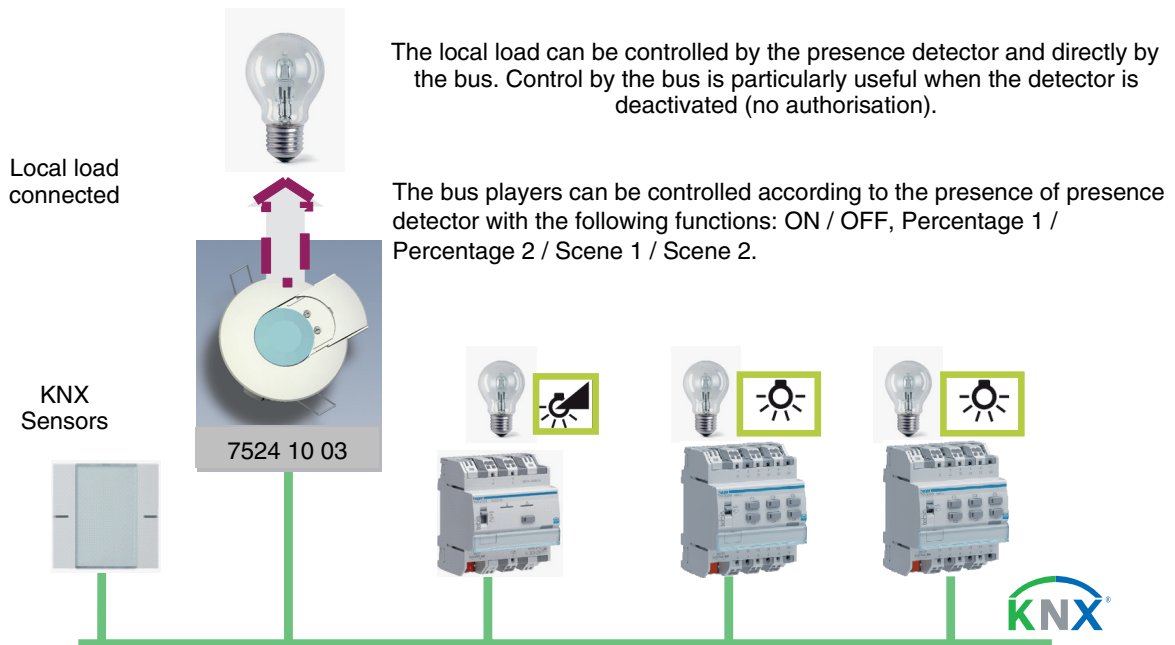

2.2.2 Presence channels 1 and 2

The presence detector has 2 presence channels which are solely controlled according to presence (luminosity is not taken into account). These parameters are used to define if Presence channels 1 and 2 are used or not.

Designation	Description	Value
Presence channel*	Used to define if the presence channel is used or not.	Not used, Used Default value: Not used

*1 or 2

2.2.3 Status at bus return when switched via detector

The changeover status of the integrated relay after the bus is powered up can be configured to ON or OFF. This parameter can be set by ETS or by a remote control.

Designation	Description	Value
Status at bus return when switched via detector	This parameter determines the changeover status of the presence detector when the bus is powered up. With the ON setting, the relay output will be activated when the bus is powered up and the presence status of the lighting channel will be sent on the bus (e.g. ON). With the OFF setting, the relay output will be deactivated when the bus is powered up and no message will be sent on the Lighting channel bus.	ON, OFF Default value: OFF

2.2.4 Setup IR remote control

The functional parameters linked to the presence detector application can be determined via the ETS parameters or using the remote control.

Setting the parameters by the remote control can be activated or deactivated. When parameter setting is activated by the remote control, it is possible to define whether the settings are overwritten by ETS or not.



Installer remote control

Designation	Description	Value
Setup IR remote control	The possibility to set the parameters by a remote control can be activated or deactivated.	Used, Not used Default value: Not used
ETS setting overwrite IR remote control data*	This parameter is used to define whether the parameter set by the remote control can be overwritten or not by the parameter set in the ETS.	Used, Not used Default value: Not used

* This parameter is only visible if the **Setting parameters by IR remote control** parameter has the following value: Used.

2.2.5 Linking Master / Slave

There are three possibilities here. You can select them with the ETS **Type of detector for master/slave links** parameter.

■ **Master detector**

The master detector activates according to the brightness and presence in its own detection area and also always activates (independently of the brightness) if a presence is detected in one of the 25 possible detection areas.

A master detector is installed preferably in a corridor (or a fictive corridor). With a master detector, we wish to ensure that if a presence is detected in the detection area, the lighting will be simultaneously activated in the circulation areas (corridors, WC, etc.).

■ **Slave detector**

The slave detector informs the master detector of a presence in its zone.

■ **Master / slave detector**

The master/slave detector activates according to the brightness and presence in its own detection area and can take into account up to 25 other detection areas. Moreover, it transmits the presence information for its own detection area to the master detector, taking into account the ambient brightness.

Designation	Description	Value
Detector type for linking master / Slave	This parameter defines the working way of the linking master / slave functionality.	Not used, Master detector, Slave detector, Master / slave detector Default value: Not used

The following example of Master / slave function demonstrates its application in an open office. There are presence detectors in working areas 1 to 5 and in the circulation area (notional corridor). Presence detectors P1, P2, P5 and P6 are defined as slave detectors. The presence detectors in the circulation area are master/slave detectors. The light in the circulation area comes on if a presence is detected in one of the working areas, independently of the measured brightness in the circulation area.

The light will also come on in the circulation area if a presence is detected only by the P3 or P4 presence detector. In this example, a presence is detected by P1, following which the lighting is activated in working area 1 and in the circulation area.

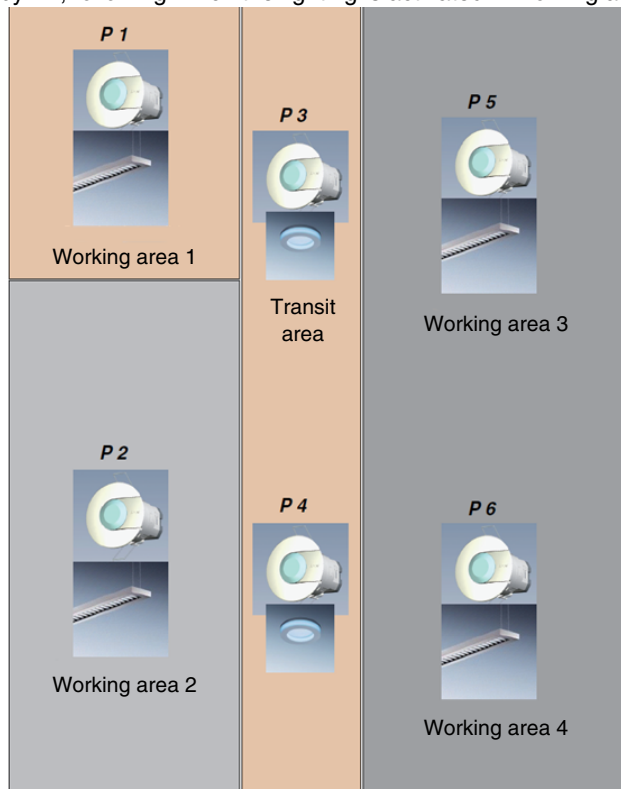

3. Configuration and parameters of the lighting channel

3.1 Objects List

Parameters	No	Name	Function of the object	Length	C	R	W	T
ON / OFF, Timer, Priority, Brightness value, Brightness value Presence / Absence	0	Lighting channel	Info ON / OFF	1 bit	C	R	W	-
ON / OFF	1	Lighting channel	ON / OFF	1 bit	C	R	-	T
Timer	2	Lighting channel	Timer	1 bit	C	R	-	T
Brightness value	4	Lighting channel	Absolute dimming	1 byte	C	R	-	T
Brightness value Presence / Absence	4	Lighting channel	Absolute dimming	1 byte	C	R	-	T
Scene	5	Lighting channel	Scene	1 byte	C	R	-	T
Scene Presence / Absence	5	Lighting channel	Scene	1 byte	C	R	-	T

→ Parameter Setting screen

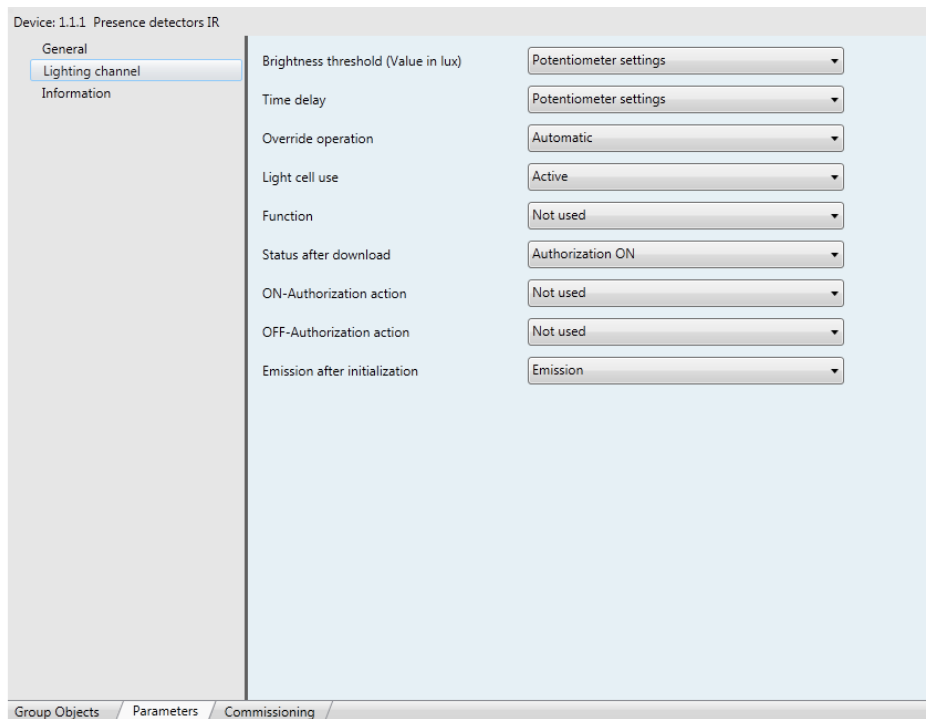

Screen 2

3.2 Value of the brightness threshold

Setting the value of the brightness threshold allows the ambient brightness (darkness) to be defined based on which recognition of a movement is analysed as a presence by the presence detector. A bus control is sent and/or the local relay output is controlled.

The brightness threshold value can be set by the ETS, the rotating potentiometer on the detector or by the remote controls .

Designation	Description	Value
Brightness threshold (Value in lux)	<p>This operating threshold defines the ambient brightness (darkness) from which the detection of a movement is analysed as a presence, a control is sent by the Lighting channel object.</p> <p>The switching OFF threshold is defined by the detector itself, it takes into account daylight filtering and brightness variation.</p>	<p>Potentiometer settings, Brightness measurement inactive, 5 lux, 50 lux, 100 lux, 200 lux, 300 lux, 400 lux, 500 lux, 600 lux, 700 lux, 800 lux, 900 lux, 1000 lux</p> <p>Default value: Potentiometer settings</p>

3.3 Time delay

The time delay is triggered when the lighting channel switches from absence (no movement) to presence (movement) by the lighting channel (**Bus** object). On this occasion, the ambient brightness is also taken into account (see the value of the brightness threshold).

The presence sensor switches to absence mode either when the time delay expires or when the ambient brightness is sufficient (no movement). According to the function set for this channel, a telegram is sent on the bus in case of Presence and / or Absence. If presence is detected, the time delay is automatically restarted. The duration of the time delay can be set by ETS, a remote control or via a setting potentiometer directly on the product.

Designation	Description	Value
Time delay	<p>The time delay determines the time the output requires to switch on (presence) after a presence is detected (brightness less than the threshold value).</p>	<p>Potentiometer settings, 5 s, 15 s, 30 s, 1 min, 2 min, 3 min, 4 min, 5 min, 10 min, 15 min, 30 min, 1 h, 2 h, 3 h, 4 h, 8 h</p> <p>Default value: Potentiometer settings</p>

3.4 Override operation

The **Remote control** object is used to control the lighting channel without taking into account either movement or the brightness threshold value.

The type of function (automatic or semi-automatic) is selected by an ETS parameter or by the remote control .

■ Semi-automatic - manual switching

In this mode, the sensor must be set to Presence by an infrared remote control or by a KNX message (**Remote control** object). As long as the presence detector recognises a presence and for the duration of the time delay, it switches on the lighting. When the presence detector switches back to Absence, it must be reactivated by a KNX message or the remote control. In this mode, a KNX message or a control by IR remote control is always required to switch on the lighting or activate the detector. Maximum energy savings can be achieved with this control type. With an ON control on the **Remote control** object, the presence detector switches to the current presence status (presence/absence).

If it is used with the remote control, an ON control during the time delay restarts it (re-triggering).

■ Automatic (If Authorisation=ON)

In this mode, the lighting is controlled according to presence and the ambient brightness. If a presence is detected and if the ambient brightness is less than the setpoint threshold value, the presence detector switches to Presence (the lighting switches on). As long as a presence is detected and the time delay has not expired (Lighting channel parameter, Time delay), the lighting stays on.

When the presence detector switches off the lighting, a new presence detection is necessary, taking into account the ambient brightness, to switch back to Presence. The mode used by the IR remote control can be modified (the default mode is Automatic).

The remote control is used here (by KNX message or IR remote control) to switch from Presence to Absence.

By an ON control on the **Remote control** object, you switch from:

- Absence to Presence and from,
- Presence to Absence.

With an OFF control on the **Remote control** object, the presence detector switches to automatic mode.

■ Remote control (If Authorisation=OFF)

In this case, the lighting channel is switched on by the KNX remote control object with an ON control on a timer (time delay duration) and is directly switched off by an OFF control. This function does not depend on presence or the ambient brightness.

Designation	Description	Value
Override operation	This parameter allows you to define the remote changeover function on the presence detector. This concerns both the Remote control KNX object and the remote control.	Automatic, Semi-automatic - manual switching. Default value: Automatic



User remote control

3.5 Light cell use

The presence detector can control the ambient brightness in two different ways.

The Active cell setting is mainly used for presence detector applications (offices). In this type of project, the brightness is measured continuously; the brightness threshold value defines the conditions for switching on the light, whereas the brightness threshold value for switching the light off (natural and artificial light filters) is defined by calculation. With this setting, in spite of Presence, the presence detector switches the light OFF if the ambient brightness exceeds the brightness setpoint during presence.

The Passive cell setting is particularly useful for corridors. Switching on the light is defined according to the brightness threshold value, and switching off depends on presence and the duration of the disconnection time delay. In this mode, the occupancy detector works like a classical motion detector. With this setting, the presence detector **does not switch off** if the ambient brightness exceeds the brightness setpoint threshold value during presence.

Designation	Description	Value
Light cell use	Use of the brightness sensor can be defined using this parameter.	Active, Passive Default value: Active

3.6 Lighting channel functions

When movement is detected, the Presence control is sent on the bus according to the ambient brightness. If no more movement is detected, the Absence control is sent on the bus at the end of the time delay (if it is set). The **Function** parameter can be used to chose which controls or values can be sent on the bus in case of presence or absence.

3.6.1 Function ON / OFF

The ON / OFF function is used to set a control output (for the lighting cycle) to a value (ON or OFF) which is predefined in the parameters in case of presence and respectively in case of absence.

ON / OFF function sends controls by the **ON / OFF** object on the bus.

Description:

Depending on the parameter settings, an ON or OFF control is sent on the bus by the **ON / OFF** object when Absence switches to Presence. At the end of the time delay, no OFF or ON control will be sent.

→ Parameter Setting screen

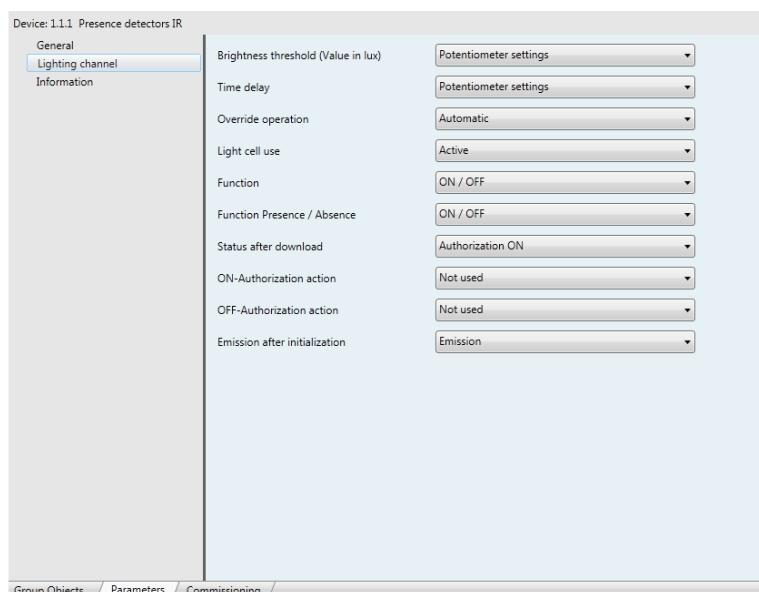

Screen 3

Designation	Description	Value
Function Presence / Absence	This parameter defines the control sent after presence or absence detection. The control in case of absence is sent at the end of the time delay.	OFF, ON, OFF / ON ON / OFF Default value: ON / OFF

3.6.2 Timer function

The Timer function is used to trigger an output (lighting) for an adjustable duration in case of presence. The Timer function sends controls by the **Timer** object.

Description:

After presence detection, the movement detector sends an ON control by the **Timer** object on the bus. Then sending of controls is locked for the time set in the **Control limitation time delay** parameter.

This means that no control will be sent even if presence is detected during this period. At the end of this period, the movement detector will send an ON control again on the bus if presence is detected and the locked period will restart. This limits the number of controls sent on the bus or allows the lighting delay to be multiplied.

Remark:

In the case of control outputs, when another ON control is received on the **Timer** object in the first 10 seconds, the lighting time delay is multiplied.

→ [Parameter Setting screen](#)

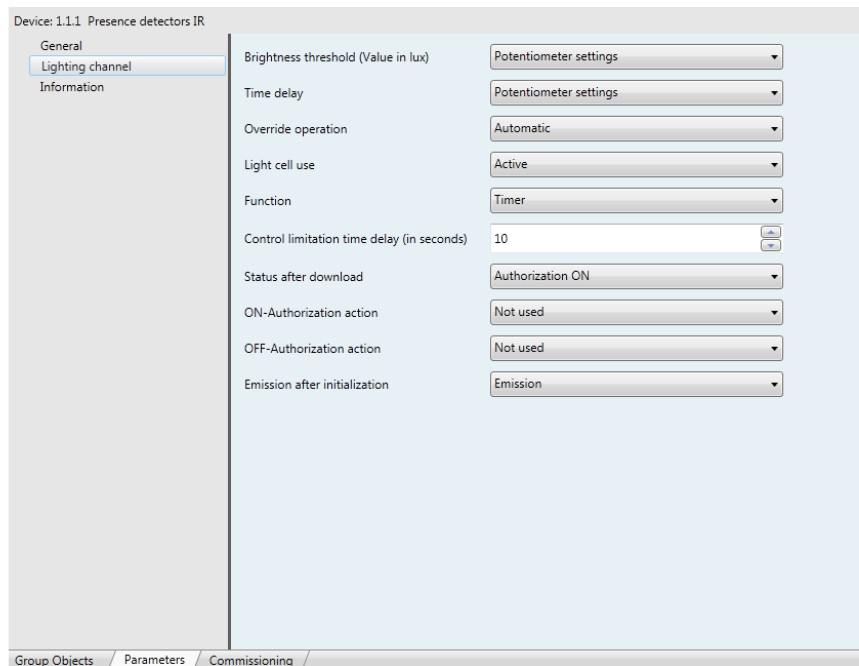

Screen 4

Designation	Description	Value
Control limitation time delay (in seconds)	This parameter is used to predetermine the minimum possible time between two Timer object messages.	From 1 to 30 in intervals of 1 Default value: 10 s

3.6.3 Brightness value and Brightness value in case of Presence / Absence functions

The Brightness value Presence function sets a dimming output to a predefined value (%) in the case of a presence.

The Brightness value Presence/Absence function sets a dimming output to a value in the case of a presence and to another level value in the case of an absence.

The Dimming in case of presence and Dimming in case of presence and absence functions send controls by the **Dimming value** object.

Description:

When switching from absence to presence, an **absolute value** (Presence) in % is sent on the bus by the **Absolute value** object. Presence and ambient brightness are taken into account for presence detection. If the time delay has expired (or if the ambient brightness is sufficient), no control or the lighting value in % is sent on the bus.

→ Parameter Setting screen

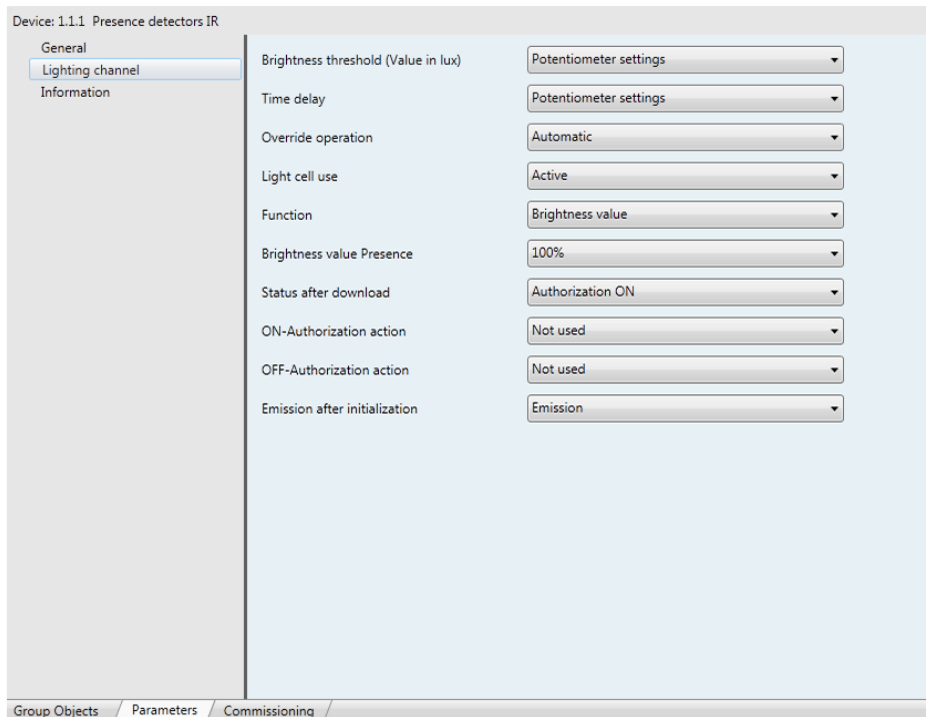

Screen 5

Designation	Description	Value
Brightness value Presence	This parameter defines the Brightness value in case of Presence.	0% to 100% in 1% steps Default value: 100%
Brightness value Absence*	This parameter defines the Brightness value in case of absence (at the end of the time delay or if the ambient brightness is sufficient).	0% to 100% in 1% steps Default value: 0%

* This parameter is only visible if the **Function** parameter has following value: Brightness value Presence / Absence.

3.6.4 Scene and Scene Presence / Absence functions

The Scene function is used to call a scene in case of presence (e.g. various ON lighting cycles, other dimming, heating ON).

The Presence/Absence scene function is used to call one scene in case of presence and another scene in case of absence.

The Scene in Presence and Scene in Presence/Absence functions send controls by the **Scene** object both in case of presence and absence.

Description:

According to the configuration, the scene number for Presence is sent on the bus by the scene object when absence switches to presence. At the end of the time delay (or if the ambient light is sufficient), no control or the scene number for Absence is sent on the bus.

→ Parameter Setting screen

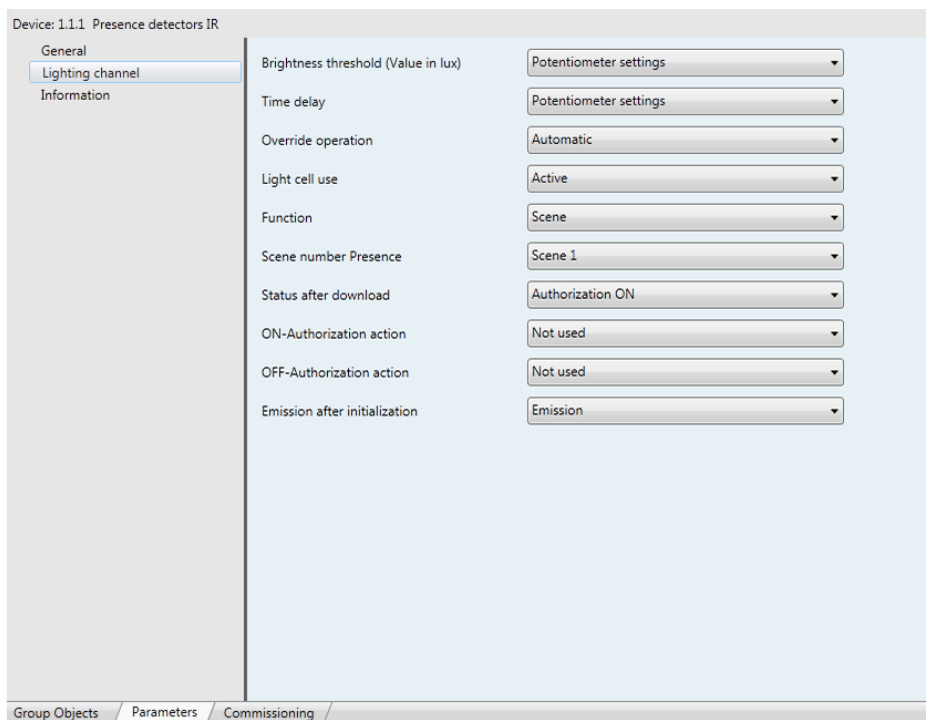

Screen 6

Designation	Description	Value
Scene number Presence	This parameter defines the scene in Presence mode.	Scene 1 to Scene 32 Default value: Scene 1
Scene number Absence*	This parameter defines the scene in Absence mode.	Scene 1 to Scene 32 Default value: Scene 2

* This parameter is only visible if the **Function** parameter has following value: Scene Presence / Absence.

3.6.5 Actions in the case of Authorisation = ON and Lighting channel = OFF

The Action for Authorisation ON and Action for Authorisation OFF parameters are used to determine how the presence detector should behave on the Lighting channel after unlocking (Authorisation = ON) or after locking (Authorisation = OFF).

Activation:

With the Activation choice, when the authorisation control (unlocking or locking) is received, the movement detector sends the movement control (Presence) on the bus.

The control sent depends on the function set.

Examples:

- The function selected is ON/OFF and the control for Presence/Absence is ON/OFF. In this case, the movement detector sends an ON control on the bus by the **ON / OFF** object after input of the Authorisation control (**Authorisation** Object).
- The selected function is Scene Presence / Absence and the scene number for Presence is scene 1. In this case, the movement detector sends the call for scene 1 by the Scene object on the bus when the Authorisation command is received (**Authorisation** object).

Deactivation:

With the Deactivation choice, when the Authorisation control (unlocking or locking) is received, the movement detector sends the no movement control (Absence) on the bus.

The control sent depends on the function set.

Examples:

- The function selected is ON/OFF and the control for Presence/Absence is ON/OFF. In this case, the movement detector sends an OFF control on the bus by the **ON / OFF** object when the Authorisation control is received (**Authorisation** object).
- The selected function is Scene Presence / Absence and the scene number for Presence is scene 2. In this case, the movement detector sends the call for scene 2 by the Scene object on the bus when the Authorisation command is received (**Authorisation** object).

Not used:

When No emission is selected, the motion detector sends, after having received the authorization command (authorization or inhibition), neither the command for motion (Presence), nor the command for no motion (Absence) on the bus.

Designation	Description	Value
ON-Authorization action	This parameter determines how the movement detector should behave when the Authorisation control = ON (unlocking) is received.	Not used, Activation, Deactivation Default value: Not used
OFF-Authorization action	This parameter determines how the movement detector should behave when the Authorisation = OFF control (locking) is received.	Not used, Activation, Deactivation Default value: Not used

3.6.6 Emission after initialization

The **Send the status after the bus is powered up** parameter is used to determine if the movement detector sends the current status or not (according to the configured function: ON/OFF, scene No. or absolute dimming) by the lighting channel after the bus is powered up. Sending the status can be useful e.g. to synchronise a visualisation.

→ Parameter Setting screen

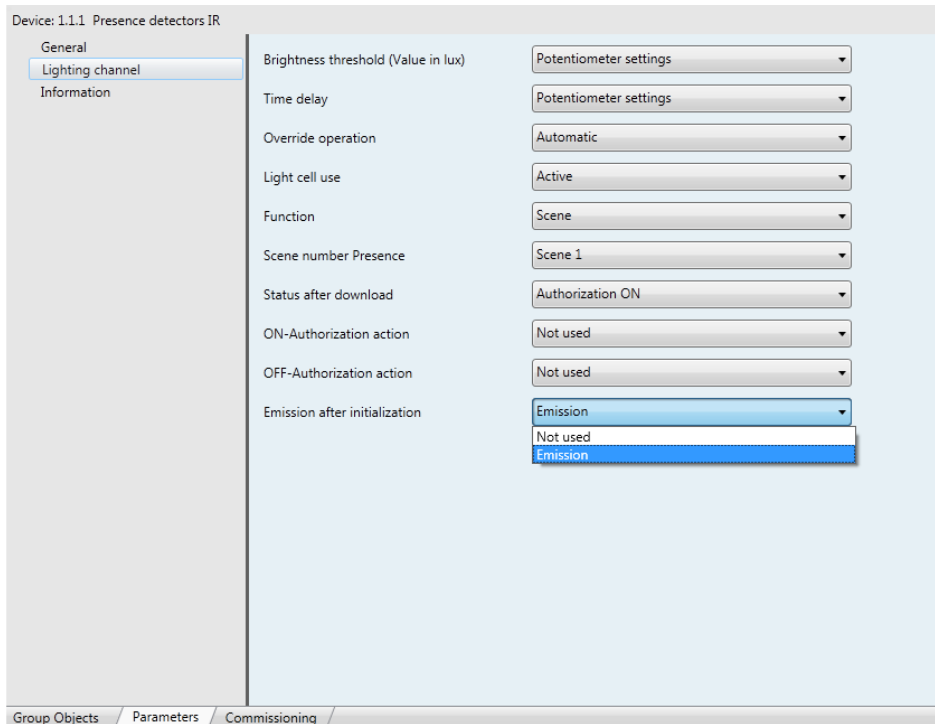

Screen 7

Designation	Description	Value
Emission after initialization	This parameter defines whether the current status will be sent after a bus failure.	Not used, Emission Default value: Emission

4. Configuration and parametering of the integrated relay output: Control by the KNX

4.1 Main functions overview

If the integrated relay output for the control by KNX bus is activated (Direct Changeover Authorisation: Active parameter), the relay output has the usual functionality of our control outputs (ON / OFF, Timer, Time limited toggle switch, Priority, Jamming, Scene, Timer and Automatic controls, Working duration counter).

Caution:

If the presence function is deactivated (Lighting channel Authorisation = ON), the relay output is always controlled by the presence detector.

If the **Relay authorisation control** parameter is deactivated, the relay is no longer controlled by the presence detector.

The main functions for control of the relay output by the KNX bus are:

■ ON / OFF

The ON/OFF function is used to switch the output on and off by the bus. The control can be communicated by switch, key, etc...

■ Status indication

The Status indication function displays the current status of the output contact. It can be used for example as status feedback for the sensor (changeover function) or for display on a viewing system.

■ Timer

The Timer function is used to switch a lighting circuit ON or OFF for an adjustable time.

For Timer = ON mode, the relay output is activated for a predetermined time and then cuts off. For Timer = OFF mode, the relay output is cut off for a predetermined time and is then reactivated.

Timer mode can be interrupted before the setpoint duration has expired. A configurable disconnection warning indicates that the end of the function is approaching by inversion of the status of the output for 1 s.

■ Time limited toggle switch

The Time delayed switch function is a combination of the ON/OFF functions by button and by staircase lighting timer. A short press on a button causes the output to switch over. If the output is on ON, it will automatically switch to OFF at the end of a programmable delay (to prevent it being forgotten).

Application:

Lighting in warehouses, cellars, store rooms, etc....

■ Priority

The Priority function forces the output to a determined status, ON or OFF.

This command has the highest priority. No other command is taken into account if a priority is active. Other controls will only be taken into account once this priority has ended.

As long as the priority is in force on the relay output, no other control will be sent on the bus by the Lighting channel (KNX object).

The lighting channel is not forced to ON or OFF status.

Application:

Maintains the lighting on for safety reasons.

■ Jamming

The Jamming function is used to freeze the current output status. This function takes priority but less than the Priority. Only once the Jamming has ended will other controls be taken into account. A time limit can be placed on the priority.

■ Scene

A scene is used to control a group of outputs. These outputs can be set to an adjustable predefined status. A scene is activated by pressing on a single button.

Each output can be incorporated in 32 different scenes.

■ Timer and Automatic controls

The Timer and Automatic controls function is used to control the output with:

- Time delay: Timer / toggle switch change over, Switching delay, Tripping delay, Switching and tripping delay, Timer,
- Automatic control functions: Authorization, AND or OR.

■ Metering

The Working duration counter is used to count the total amount of time an output has been operating in ON or OFF status. An alarm setpoint value can be programmed.

4.2 Objects List

No	Name	Function of the object	Length	C	R	W	T
18	Output 1	ON / OFF	1 bit	C	R	W	-
19	Output 1	Timer	1 bit	C	R	W	-
20	Output 1 and Lighting channel	Priority	2 bit	C	R	W	-
21	Output 1	Scene	1 byte	C	R	W	-
22	Output 1	Status indication	1 bit	C	R	-	T
51	Output 1	Jamming	1 bit	C	R	W	-
52	Output 1	Automatic control	1 bit	C	R	W	-
53	Output 1	Scene 1 bit	1 bit	C	R	W	-
54	Output 1	Metering	4 bytes	C	R	W	-
55	Output 1	Counter set point reached	1 bit	C	R	-	T
56	Output 1	Time limited toggle switch	1 bit	C	R	W	-
57	Output 1	Reset of hours counter	1 bit	C	R	W	-
58	All lighting outputs	Restore scenes	1 bit	C	R	W	-

4.3 Function Description

4.3.1 ON / OFF functions and Status indication

The ON/OFF function is used to set the output to ON or OFF using the **ON / OFF** object.

The status of the output depends on other objects and parameters: Priority, Output type, Automatic control, Scene, etc.

The real output status is indicated by the bus using the **Status indication** object.

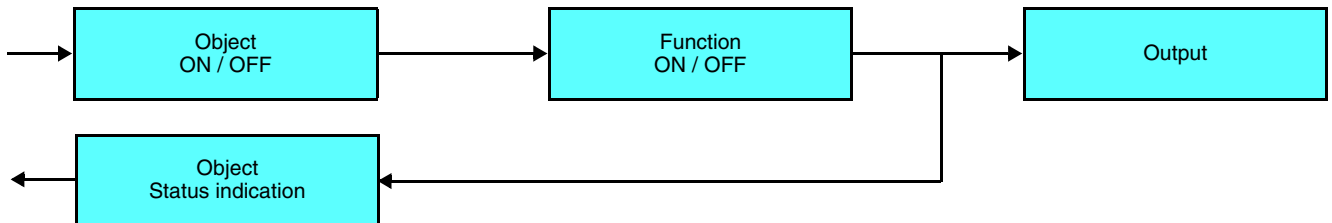

4.3.2 Timer functions

The function is launched by the **Timer** object.

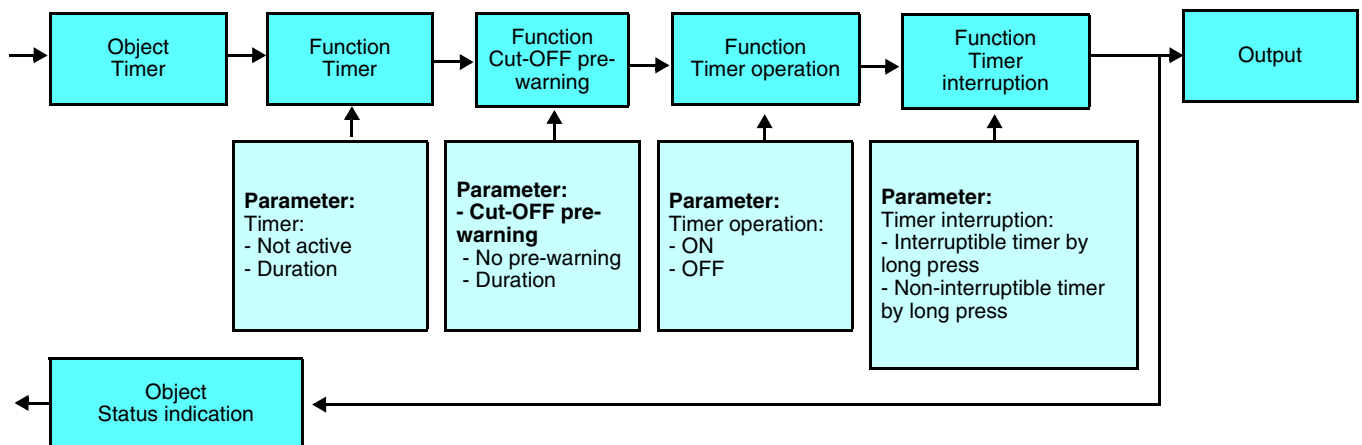

→ Parameter Setting screen

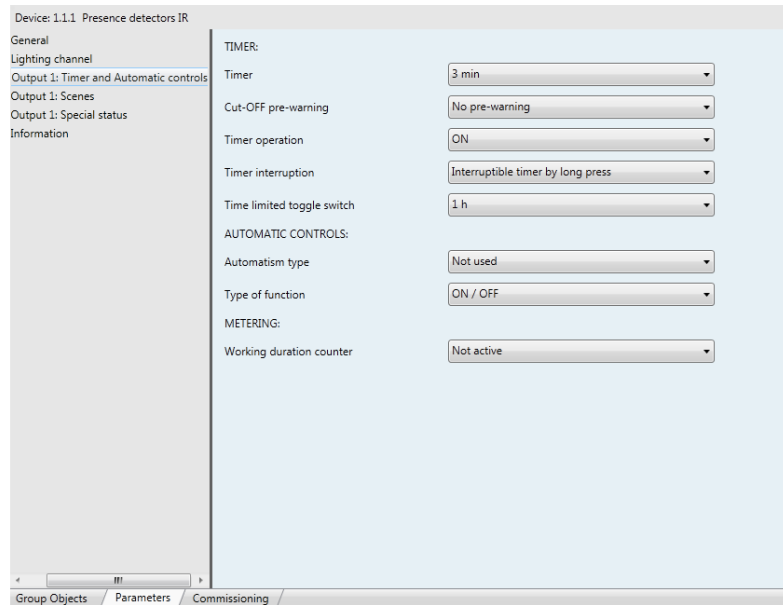

Screen 8

Designation	Description	Value
Timer	This parameter is used to set the duration that the light is switched on or off.	Not active, Range [0.5 s - 24 h]* Default value: 3 min
Cut-OFF pre-warning (for ON mode)	If the cut-off pre-warning is active, the output switches off for 1 s. This parameter determines how long the pre-warning will be triggered before the timer function expires.	No pre-warning, 15 s, 30 s, 1 min Default value: No pre-warning
Timer operation	This parameter is used to determine if the output is activated or deactivated during timer mode. In Timer = ON mode, the output goes off at the end of the time delay. In Timer = OFF mode, the output switches on at the end of the time delay.	ON, OFF Default value: ON
Timer interruption	This parameter is used to allow (or prevent) the interruption of Timer mode by the reception of an OFF control from the Timer object. The OFF control can be triggered by a long press on a button with the Timer function, for example.	Interruptible by long press, Non-interruptible timer by long press Default value: Interruptible by long press

* Setting range [0.5 s - 24 h]

0.5 s, 1 s, 2 s, 3 s, 5 s, 10 s, 15 s, 20 s, 30 s, 40 s, 45 s, 50 s, 1 min, 1 min 15 s, 1 min 30 s, 2 min, 2 min 30 s, 3 min, 4 min, 5 min, 6 min, 7 min, 8 min, 9 min, 10min, 11min, 12min, 13 min, 14 min, 15 min, 20 min, 30 min, 40 min, 50 min, 1 h, 1 h 30 min, 2 h, 2 h 30 min, 3 h, 3 h 30 min, 4 h, 5 h, 6 h, 12 h, 24 h.

Remark:

- If other ON controls are received on the **Timer** object within 10 seconds after the start of the Timer function, the ON duration will be extended by the duration configured for each ON control. For example, if a new control is received, the duration is doubled. Two more will cause it to triple,
- An ON control on the **Timer** object more than 10 s after the start of the Timer mode restarts Timer mode.

4.3.3 Time limited toggle switch function

The Time delayed switch function is a combination of the ON/OFF functions by button and the Timer (energy saving) function. If the output is activated, it automatically switches off at the end of a predetermined time (to prevent it being forgotten. The function is used by the **Time delayed switch** object. A new ON control on the object resets this duration to 0. It is impossible to extend this duration in the first 10 seconds, as for the time delay function.

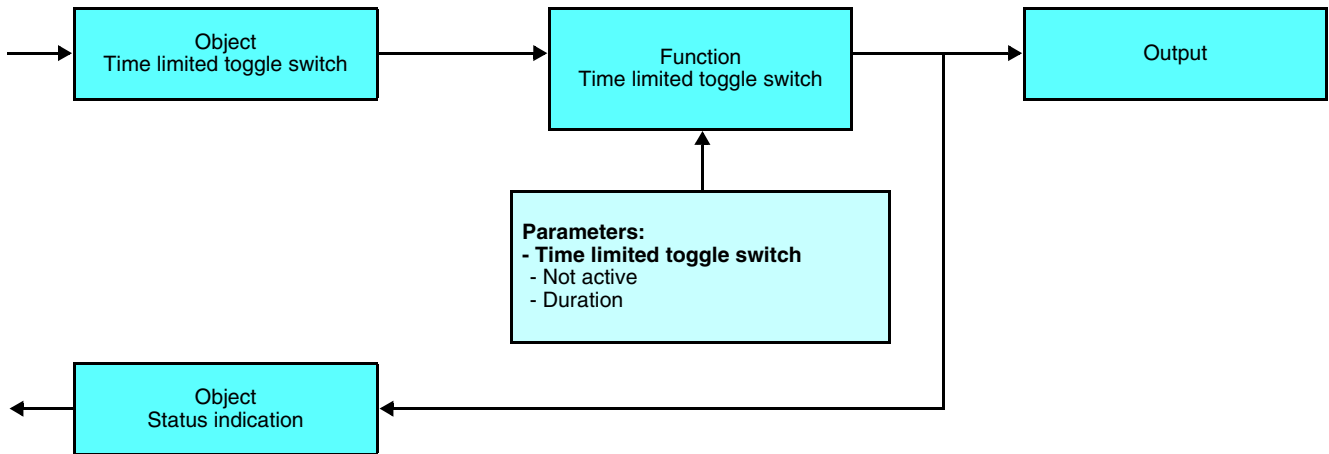

Designation	Description	Value
Time limited toggle switch	This parameter sets the changeover duration.	Not active, Range [0.5 s - 24 h]* Default value: 1 h

* Setting range [0.5 s - 24 h]

0.5 s, 1 s, 2 s, 3 s, 5 s, 10 s, 15 s, 20 s, 30 s, 40 s, 45 s, 50 s, 1 min, 1 min 15 s, 1 min 30 s, 2 min, 2 min 30 s, 3 min, 4 min, 5 min, 6 min, 7 min, 8 min, 9 min, 10min, 11min, 12min, 13 min, 14 min, 15 min, 20 min, 30 min, 40 min, 50 min, 1 h, 1 h 30 min, 2 h, 2 h 30 min, 3 h, 3 h 30 min, 4 h, 5 h, 6 h, 12 h, 24 h.

4.3.4 Priority function

The Priority function allows the outputs to be forced and maintained at a definite ON or OFF status imposed by the input. This function is started by the **Priority** object. Priority is the function with the highest priority. Only a cancellation command for the priority can end the priority and authorise the bus commands to be followed again.

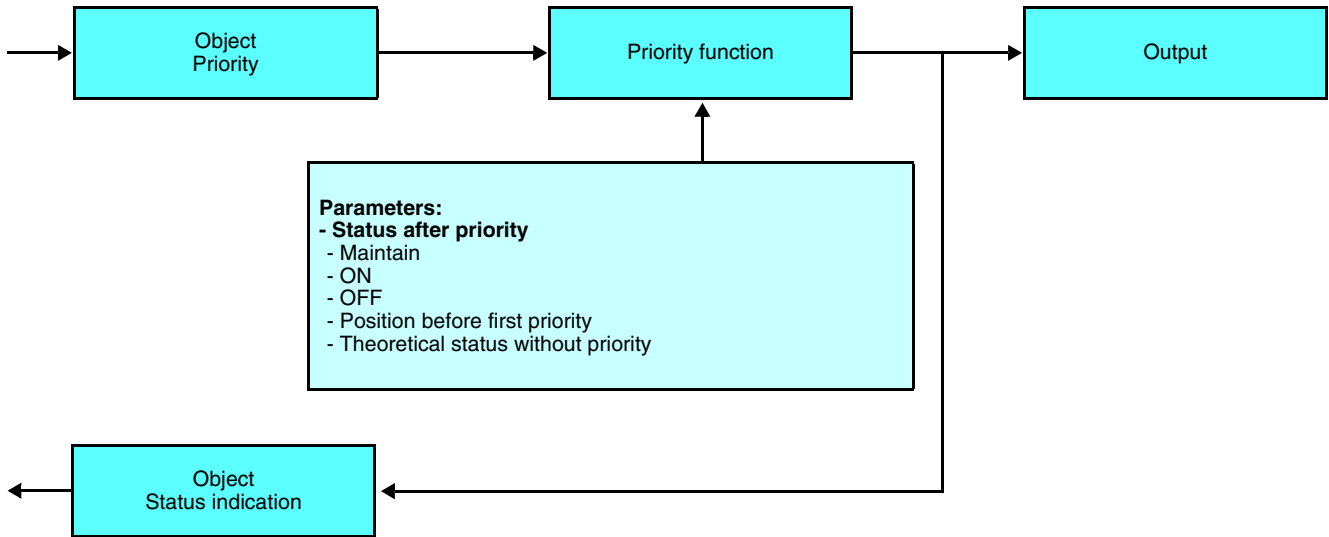

Parameters:
 - Status after priority
 - Maintain
 - ON
 - OFF
 - Position before first priority
 - Theoretical status without priority

→ Description of the **Priority** object

Bit 1	Bit 0
Output behaviour	
Output behaviour	00 = Priority end 01 = Priority end 10 = Priority OFF 11 = Priority ON

→ Parameter Setting screen

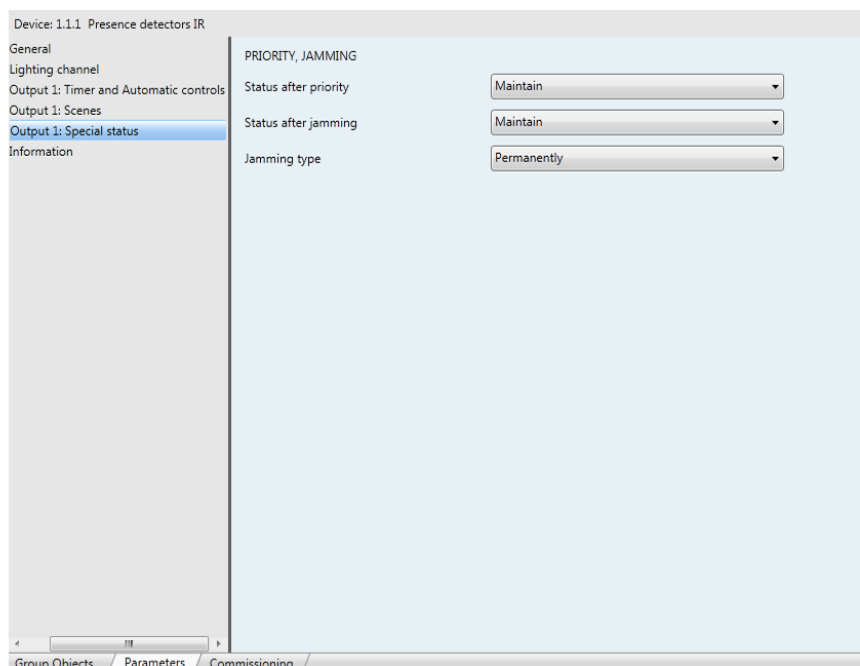

Screen 9

Designation	Description	Value
Status after priority	This parameter defines the output status to be applied at the end of the Priority.	Maintains the position, Inversion, ON, OFF. Status before priority, Theoretical status without priority. <ul style="list-style-type: none"> - Maintains the position: With this setting, the status consigned by the priority (ON/OFF) will be maintained after the end of the priority. - Inversion: Inverses the output value which was present during the priority (ON switches to OFF, OFF switches to ON). - ON: Sets the output to ON. - OFF: Sets the output to OFF. - Theoretical status without priority: This value places the output in the status which would have prevailed if the priority had not occurred. Default value: Maintain

4.3.5 Jamming function

The Jamming function allows the outputs to be locked in their current status.

This function is started by the **Jamming** object. The Jamming function is the function with the second highest priority after Priority. A **Jamming Cancellation** control ends the jamming and authorises controls from the bus and detector to be taken into account once more.

A **Priority** command ends the **Jamming**.

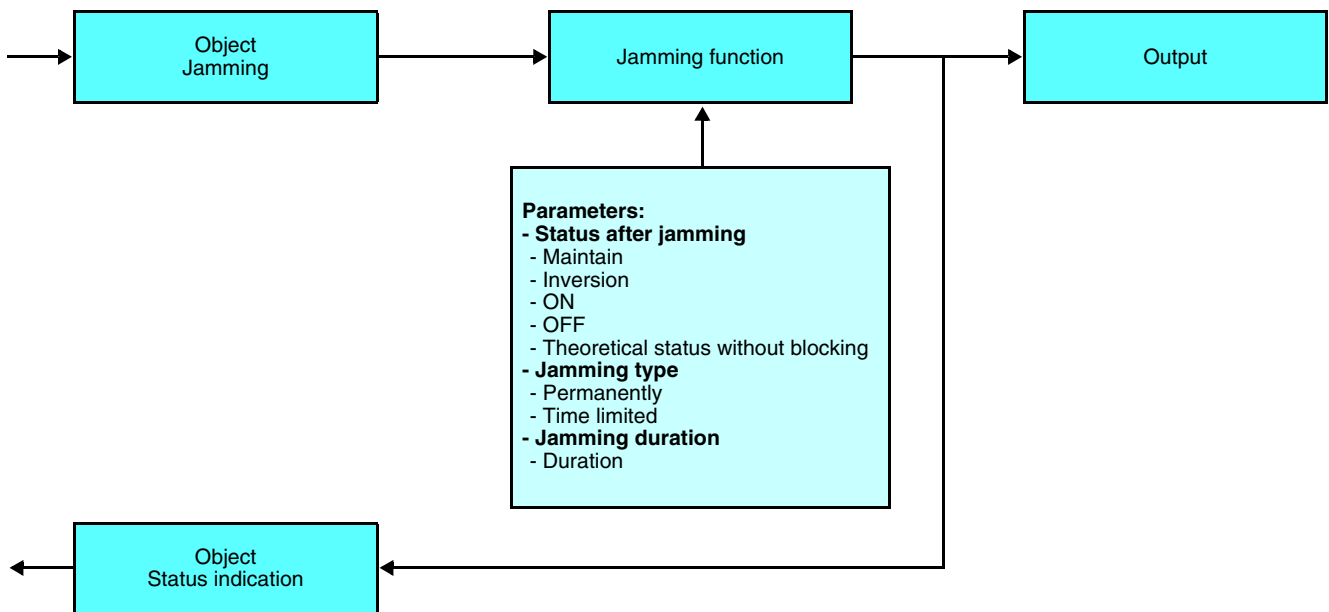

Designation	Description	Value
Status after jamming	This parameter defines the output status to be applied at the end of the Jamming.	Maintains the position, Inversion, ON, OFF, Theoretical status without blocking. <ul style="list-style-type: none"> - Maintains the position: Maintains the output value in force in jammed status. - Inversion: Inverses the output value in force during jammed status (ON switches to OFF, OFF switches to ON). - ON: Sets the output to ON. - OFF: Sets the output to OFF. - Theoretical status without blocking: Switches the output to the status that would be active if no Jamming command had occurred. Default value: Maintain
Jamming type	This parameter defines whether Jamming is permanent or time limited.	Permanently, Time limited. <ul style="list-style-type: none"> - Time limited: Jamming is active for a parameterisable limited duration. Default value: Permanently
Jamming duration**	This parameter defines the Jamming duration.	Range [0 s - 24 h]* Default value: 1 h

* Setting range [0.5 s - 24 h]

0 s, 0.5 s, 1 s, 2 s, 3 s, 5 s, 10 s, 15 s, 20 s, 30 s, 40 s, 45 s, 50 s, 1 min, 1 min 15 s, 1 min 30 s, 2 min, 2 min 30 s, 3 min, 4 min, 5 min, 6 min, 7 min, 8 min, 9 min, 10min, 11min, 12min, 13 min, 14 min, 15 min, 20 min, 30 min, 40 min, 50 min, 1 h, 1 h 30 min, 2 h, 2 h 30 min, 3 h, 3 h 30 min, 4 h, 5 h, 6 h, 12 h, 24 h.

** This parameter is only visible if the **Jamming type** parameter has following value: Time limited.

4.3.6 Scene function

A scene is used to control a group of outputs. Each of the outputs in the group will be set to a status pre-defined for the scene. The outputs which are to be activated during the scene and the button which activates the scene keep the same group address. Each output can be integrated in 32 different scenes.

The status of each output can be set for a scene by the parameters or can be defined with the sensors on the device.

A. Configuration and storing by parameterisation

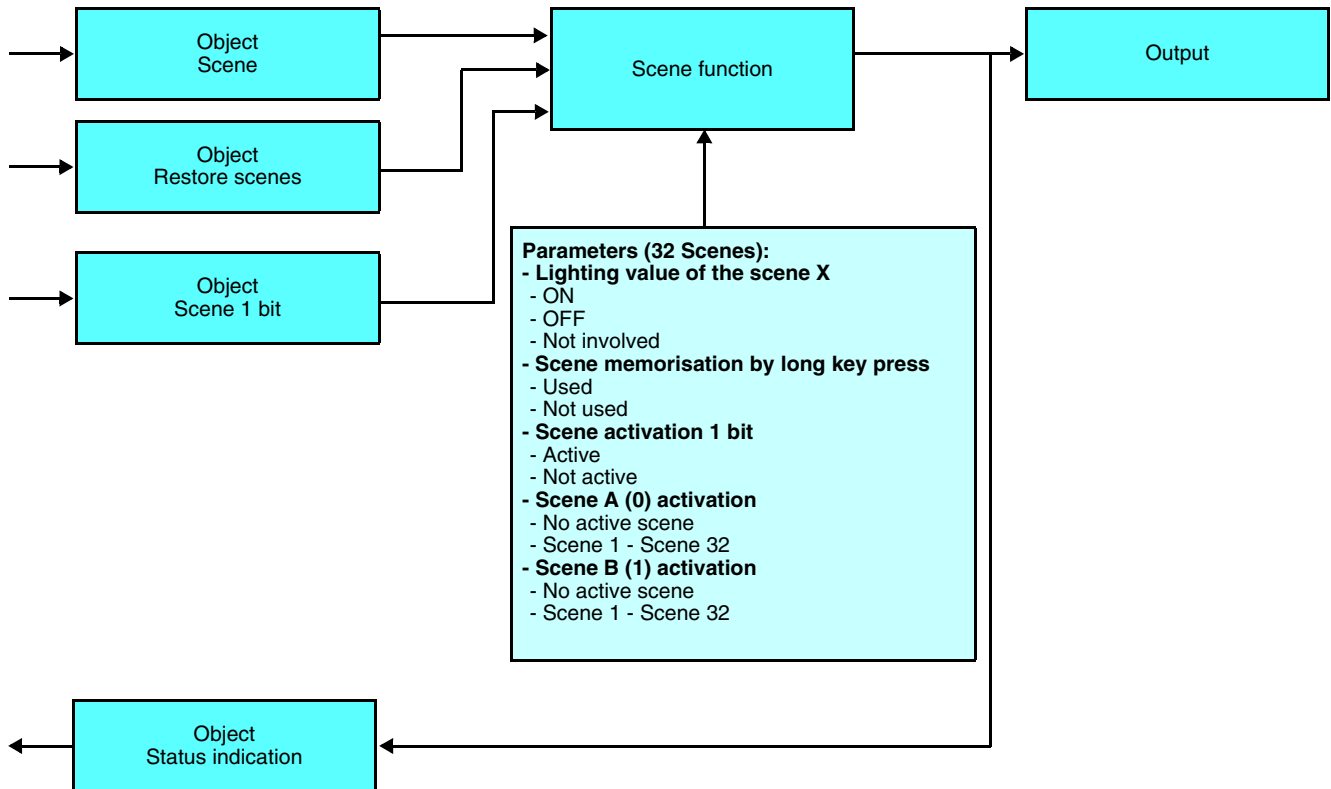

Description of **Scene** objects (1 byte)

7	6	5	4	3	2	1	0
Learn	X	Scene number					

Designation	Description	Value
Output status for scene X	This parameter defines the output status for scene X.	ON, OFF, Not involved - Remark: If the value of the parameter is Not involved, the scene will not influence this output. Default value: ON
Scene memorisation by long key press	This parameter authorizes or forbids scene the scene memorisation after a long key press (Reaction to the scene message with the fixed "learning" bit).	Used, Not used Default value: Used
Scene activation 1 bit	If this parameter is active, it is possible to activate 2 out of 32 possible scenes using the scene 1 bit object.	Not active, Active Default value: Not active
Scene A (0) activation / Scene B (1) activation*	When the parameter Scene activation 1 bit has the value Active, the parameters Scene activation A and Scene activation B must be set. These parameters define the scenes to be activated for the two values of the Scene 1 bit object.	No active scene, Scene 1 to Scene 32 Default value: No active scene

* This parameter is only visible if the **Scene activation 1 bit** parameter has following value: Active.

Remark:

With the **Restore scenes** object, which can be configured in the General files menu, the scene values programmed by ETS are reactivated when this object is received (see § General Parameters).

B. Learning and storing in the room

This procedure modifies and stores a scene by local action on the push buttons located in the room.

- Briefly press the scene call button,
- Set the outputs to the desired status using the push buttons that control them individually,
- Store the output statuses by pressing the room push button that triggers the scene for longer than 5 s. The storage is indicated by the status inversion of the involved outputs for 3 sec.

4.3.7 Timer and Automatic controls

The Timer and Automatic controls operating area is used to control the output with:

- ON / OFF,
- Time delay: Switching delay, Tripping delay, Switching and tripping delay, Timer,
- Automatism type: Authorization, AND or OR.

The status of the output depends on the combination of the parameters **Type of automatic control** and **Control type**.

Setting:

Unused Automatic function (the **Automatic control** object is not visible).

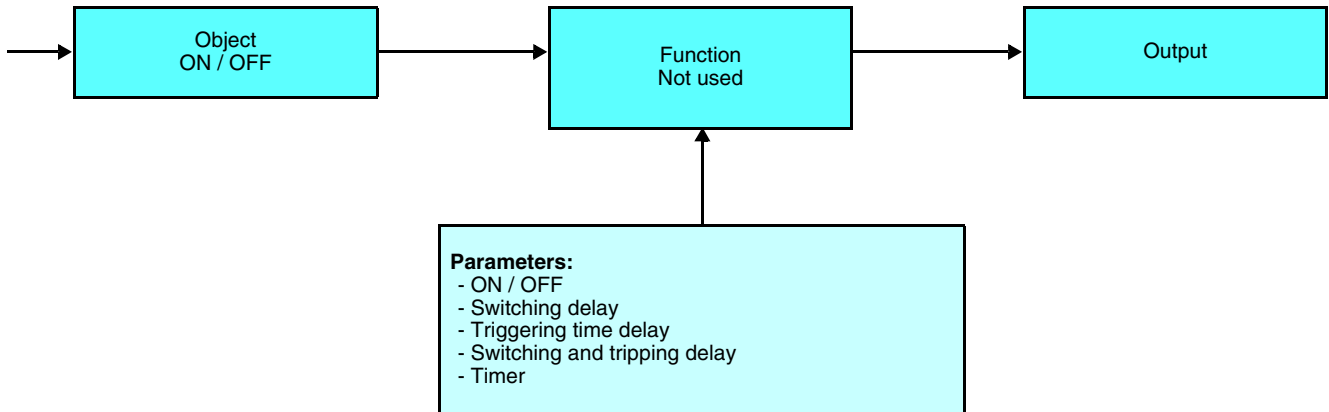

Automatism type	Control type	Operation	Parameter
Not used (Default value)	ON / OFF (Default value)	The output is controlled directly.	
	Switching delay	Activation of the output is delayed.	Switching delay: [0.5 s - 24 h]* Default value: 3 min
	Tripping delay	Deactivation of the output is delayed.	Tripping delay: [0.5 s - 24 h]* Default value: 3 min
	Switching and tripping delay	Activation and deactivation of the output are delayed. The time delay for activation and deactivation can be different.	Switching delay: [0.5 s - 24 h]* Default value: 3 min Tripping delay: [0.5 s - 24 h]* Default value: 3 min
	Timer	The output can be activated and deactivated directly by the ON/OFF object. In the absence of any OFF control during the configured duration, the output is automatically deactivated. Depending on the operation selected for the timer, the output activates or deactivates for the configured duration when an ON control is received.	Time switch delay: [0 s - 24 h]* Default value: 3 min Timer operation: ON, OFF Default value: ON

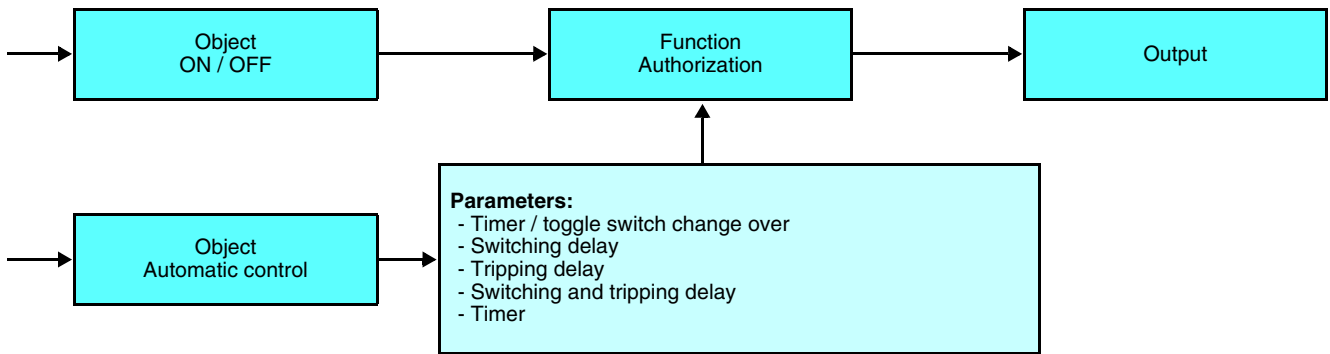
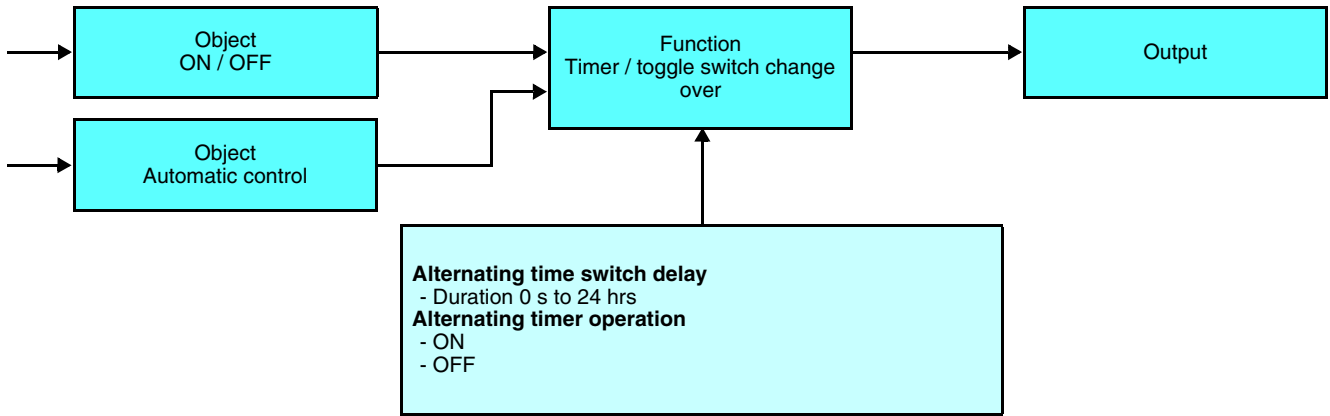

Automatism type	Control type	Operation	Parameter
Authorization	Timer / toggle switch change over	The output is controlled directly by the ON/OFF object if the value of the Automatic control object is ON. If the value of the Automatic control object is OFF, the output will automatically be activated or deactivated at the end of the configured time.	Time switch delay: [0 s - 24 h]* Default value: 3 min Timer / toggle switch change over: ON, OFF Default value: ON
	Switching delay	The output is activated with a delay if the value of the Automatic control object is ON. If the value of the Automatic control object is OFF, the controls on the ON/OFF object are not taken into account.	Switching delay: [0.5 s - 24 h]* Default value: 3 min
	Tripping delay	The output is deactivated with a delay if the value of the Automatic control object is ON. If the value of the Automatic control object is OFF, the controls on the ON/OFF object are not taken into account.	Tripping delay: [0.5 s - 24 h]* Default value: 3 min
	Switching and tripping delay	The output is activated and deactivated with a delay if the value of the Automatic control object is ON. If the value of the Automatic control object is OFF, the controls on the ON/OFF object are not taken into account.	Switching delay: [0.5 s - 24 h]* Default value: 3 min Tripping delay: [0.5 s - 24 h]* Default value: 3 min
	Timer	If the value of the Automatic control object is ON, the output can be activated or deactivated directly by the ON/OFF object. In the absence of any OFF control during the configured duration, the output is automatically deactivated. Depending on the operation selected for the timer, the output activates or deactivates for the configured duration when an ON control is received. If the value of the Automatic control object is OFF, the controls on the ON/OFF object are not taken into account.	Time switch delay: [0 s - 24 h]** Default value: 3 min Timer operation: ON, OFF Default value: ON

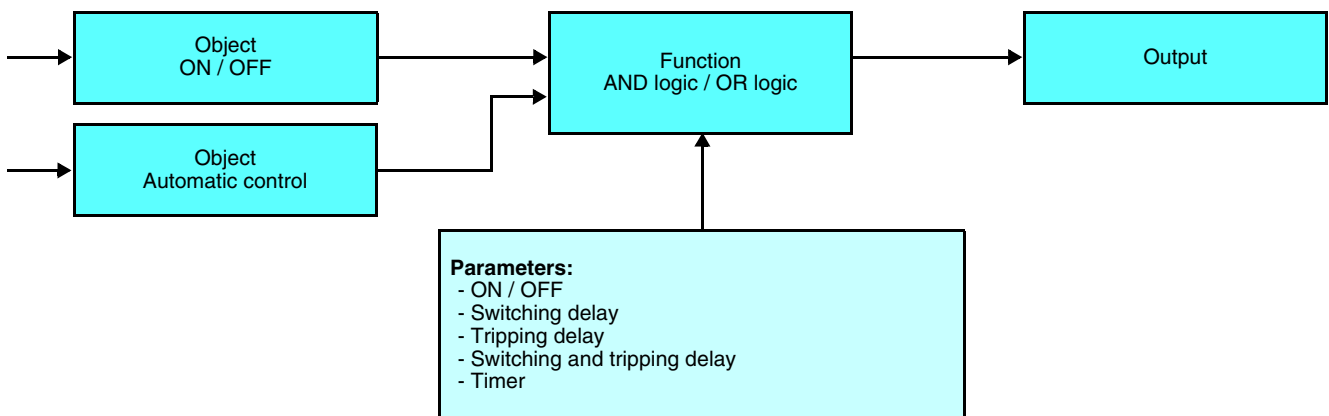

Automatism type	Control type	Operation	Parameter
AND	ON / OFF	The output is the result of the AND logic between the value of the ON / OFF object and the value of the Automatic control object.	
	Switching delay	The output is the result of the AND logic between the ON/OFF object and the Automatic control object. Activation of the output by the ON/OFF object is delayed.	Switching delay: [0.5 s - 24 h]* Default value: 3 min
	Tripping delay	The output is the result of the AND logic between the ON/OFF object and the Automatic control object. Deactivation of the output by the ON/OFF object is delayed.	Tripping delay: [0.5 s - 24 h]* Default value: 3 min
	Switching and tripping delay	The output is the result of the AND logic between the ON/OFF object and the Automatic control object. Activation and deactivation of the output by the ON/OFF object are delayed.	Switching delay: [0.5 s - 24 h]* Default value: 3 min
			Tripping delay: [0.5 s - 24 h]* Default value: 3 min
	Timer	The output is the result of the AND logic between the value of the ON/OFF object and with changeover function and the Automatic control object.	Time switch delay: [0 s - 24 h]** Default value: 3 min Timer operation: ON, OFF Default value: ON

Automatism type	Control type	Operation	Parameter
OR	ON / OFF	The output is the result of the OR logic between the value of the ON / OFF object and the value of the Automatic control object.	
	Switching delay	The output is the result of the OR logic between the value of the ON / OFF object and the value of the Automatic control object. Activation of the output by the ON/OFF object is delayed.	Switching delay: [0.5 s - 24 h]* Default value: 3 min
	Tripping delay	The output is the result of the OR logic between the value of the ON / OFF object and the value of the Automatic control object. Deactivation of the output by the ON/OFF object is delayed.	Tripping delay: [0.5 s - 24 h]* Default value: 3 min
	Switching and tripping delay	The output is the result of the OR logic between the value of the ON / OFF object and the value of the Automatic control object. Activation and deactivation of the output by the ON/OFF object are delayed.	Switching delay: [0.5 s - 24 h]* Default value: 3 min
			Tripping delay: [0.5 s - 24 h]* Default value: 3 min
Timer	The output is the result of the OR logic between the value of the ON/OFF object with Timer function and the value of the Automatic control object.	Time switch delay: [0 s - 24 h]** Default value: 3 min	
		Timer operation: ON, OFF Default value: ON	

* Setting range [0.5 s - 24 h]

0.5 s, 1 s, 2 s, 3 s, 5 s, 10 s, 15 s, 20 s, 30 s, 40 s, 45 s, 50 s, 1 min, 1 min 15 s, 1 min 30 s, 2 min, 2 min 30 s, 3 min, 4 min, 5 min, 6 min, 7 min, 8 min, 9 min, 10min, 11min, 12min, 13 min, 14 min, 15 min, 20 min, 30 min, 40 min, 50 min, 1 h, 1 h 30 min, 2 h, 2 h 30 min, 3 h, 3 h 30 min, 4 h, 5 h, 6 h, 12 h, 24 h.

** Setting range [0 s - 24 h]

0 s, 0.5 s, 1 s, 2 s, 3 s, 5 s, 10 s, 15 s, 20 s, 30 s, 40 s, 45 s, 50 s, 1 min, 1 min 15 s, 1 min 30 s, 2 min, 2 min 30 s, 3 min, 4 min, 5 min, 6 min, 7 min, 8 min, 9 min, 10min, 11min, 12min, 13 min, 14 min, 15 min, 20 min, 30 min, 40 min, 50 min, 1 h, 1 h 30 min, 2 h, 2 h 30 min, 2 h, 2 h 30 min, 4 h, 5 h, 6 h, 12 h, 24 h.

4.3.8 Metering (Working duration counter)

With the metering function, the total duration of an output in ON or OFF status can be determined. The value is transmitted with the **Metering** object. You can both increase the number of operating hours and count them down from a defined value. A setpoint value can be set when an alarm will be triggered. The alarm is transmitted by the **Counter set point reached** object.

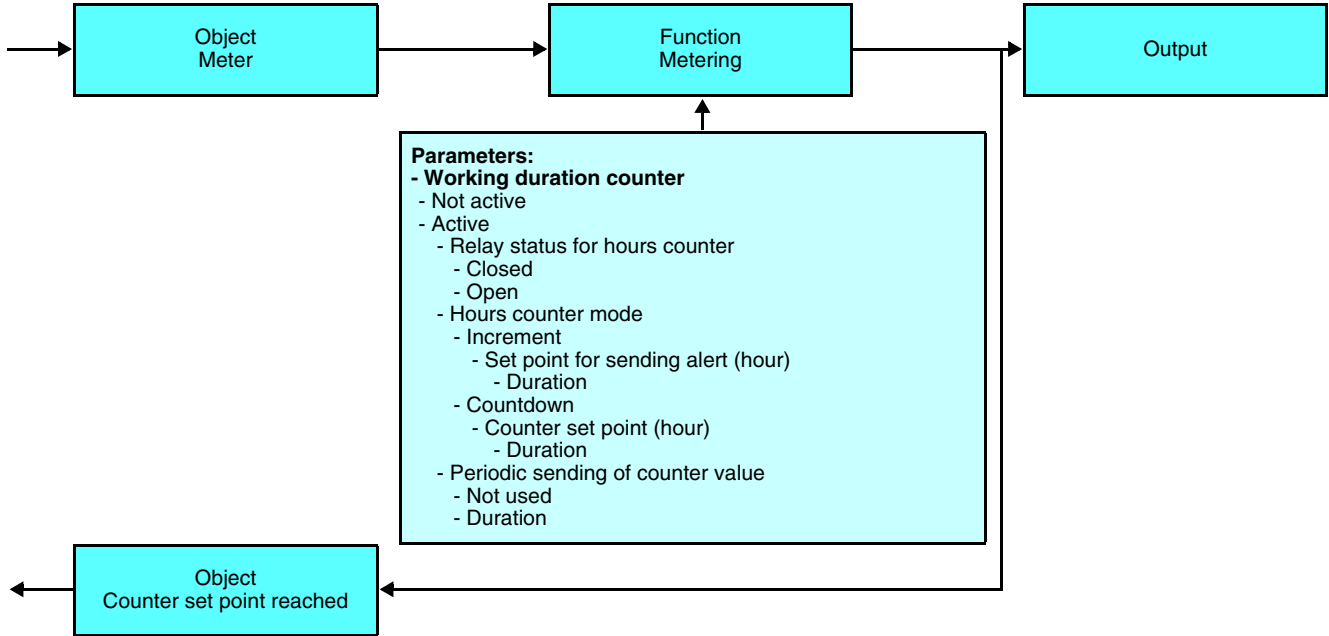

Designation	Description	Value
Working duration counter	This parameter is used to activate metering. The countdown value can be read by the Working duration counter object.	Not active, Active Default value: Not active
Relay status for hours counter*	This parameter is used to select the changeover status for which the total operating time is to be counted.	Closed, Open Default value: Closed
Hours counter mode*	This parameter defines the Hours counter mode.	Increment, Countdown Default value: Increment
Set point for sending alert (hour)*	This parameter defines a warning threshold such that if it is reached, the Counter setpoint reached object will be sent.	From 0 to 10000 hours with 1-hour steps - Remark: The Counter setpoint reached object can be reset either by downloading the application software again, or using the Working duration counter reset object. Default value: 1000
Periodic sending of counter value*	This parameter defines the time interval for periodical sending of the Metering object.	Not used, [5 s - 24 h]** Default value: Not used
Counter set point (hour)*	This parameter defines a warning threshold such that if it is reached, the Counter setpoint reached object will be sent.	From 0 to 10000 hours with 1-hour steps Default value: 1000

* This parameter is only visible if the **Counter function** parameter has following value: Active.

** Setting range [5 s - 24 h]

5 s, 10 s, 30 s, 5 min, 10min, 20 min, 30 min, 40 min 50 min, 1 h, 1 h 30 min, 2 h, 2 h 30 min, 3 h, 3 h 30 min, 4 h, 5 h, 6 h, 12 h, 24 h.

5. Configuration of Presence Channels 1 and 2

5.1 Objects List

Parameters	No	Name	Function of the object	Length	C	R	W	T
Value in %, Lighting, Timer	8	Presence channel 1	Info ON / OFF	1 bit	C	R	W	-
	13	Presence channel 2	Info ON / OFF	1 bit	C	R	W	-
Value in %, Lighting	9	Presence channel 1	ON / OFF	1 bit	C	R	-	T
	14	Presence channel 2	ON / OFF	1 bit	C	R	-	T
Value in %	12	Presence channel 1	Brightness value	1 byte	C	R	-	T
	17	Presence channel 2	Brightness value	1 byte	C	R	-	T
Timer	9	Presence channel 1	Timer	1 bit	C	R	-	T
	14	Presence channel 2	Timer	1 bit	C	R	-	T
Scene	12	Presence channel 1	Scene	1 byte	C	R	-	T
	17	Presence channel 2	Scene	1 byte	C	R	-	T
Shutters / blinds	9	Presence channel 1	Up / Down	1 bit	C	R	-	T
	14	Presence channel 2	Up / Down	1 bit	C	R	-	T
	10	Presence channel 1	Slat angle / Stop	1 bit	C	R	-	T
	15	Presence channel 2	Slat angle / Stop	1 bit	C	R	-	T
Priority	11	Presence channel 1	Priority	2 bit	C	R	-	T
	16	Presence channel 2	Priority	2 bit	C	R	-	T
Heating	12	Presence channel 1	Heating mode	1 byte	C	R	-	T
	17	Presence channel 2	Heating mode	1 byte	C	R	-	T
Heating activation	9	Presence channel 1	Heating activation	1 bit	C	R	-	T
	14	Presence channel 2	Heating activation	1 bit	C	R	-	T
Value in %, Lighting, Timer, Scene, Shutters / blinds, Priority, Heating, Heating activation	49	Presence channel 1	Surveillance sensitivity	1 bit	C	R	W	-
	50	Presence channel 2	Surveillance sensitivity	1 bit	C	R	W	-

→ Parameter Setting screen

Screen 10

An additional parameter is associated with each value of the **Function** parameter in order to specify the operating mode.

Function parametr value	Additional parameter(s) appearing for the Function value
Value in %	Choice of edge
	Control on Presence
	Control on absence
Lighting	Control on Presence
	Control on absence
Timer	Control on Presence
	Control on absence
	Control limitation time delay (in seconds)
Scene	Control on Presence
	Control on absence
Shutters / blinds	Control on Presence
	Control on absence
Priority	Control on Presence
	Control on absence
Heating	Control on Presence
	Control on absence
Metering activation	Control on Presence
	Control on absence

5.2 Value in %

This function is used to emit the lighting dimming controls on 1 or 2 levels: a value after presence detection and possibly another value at the end of the presence time delay. This function emits the **ON / OFF** and **Lighting value** objects. The status of the controlled output is received on the **Info ON/OFF** object which can condition the initial control.

Designation	Description	Value
Choice of edge	Used to chose which event triggers sending the object.	Presence, Absence, Presence / Absence Default value: Presence / Absence
Control on Presence	This parameter is used to define the control emitted after presence detection.	0% - 100% Default value: 0%
Control on absence	This parameter is used to define the control emitted when there is no presence detection.	0% - 100% Default value: 0%

5.3 Lighting function

This function is used to switch the lighting circuit or any other load ON or OFF . The Lighting function emits the **ON / OFF** object. The status of the controlled output is received on the **Info ON/OFF** object which can condition the initial control.

Designation	Description	Value
Control on Presence	This parameter is used to define the control emitted after presence detection.	Not used, ON, OFF, Toggle switch Default value: ON
Control on absence	This parameter is used to define the control emitted when there is no presence detection.	Not used, ON, OFF, Toggle switch Default value: OFF

5.4 Timer function

This function is used to switch the lighting circuit or any other load ON or OFF. The Timer function sends the **Timer** object. The status of the controlled output is received on the **Info ON/OFF** object which can condition the initial control.

Designation	Description	Value
Control on Presence	This parameter is used to define the control emitted after presence detection.	Not used, Start, Stop Default value: Stop
Control on absence	This parameter is used to define the control emitted when there is no presence detection.	Not used, Start, Stop Default value: Not used
Control limitation time delay (in seconds)		1 - 30 Default value: 8

5.5 Scene function

The Scene and Presence/Absence Scene functions are used to send group controls to different types of outputs to create ambiances or scenarios (leave scenario, reading ambience, etc.). These functions send the **Scene** object. Please note, the product can only activate a scene. To record a scene another input must be used (which you can remove after recording).

Designation	Description	Value
Control on Presence	Defines the number of the scene sent after a presence is detected.	Not used, Scene 1 to 32 Default value: Not used
Control on absence	Defines the number of the scene sent at the end of the time delay.	Not used, Scene 1 to 32 Default value: Not used

5.6 Shutter/Blind function

This function is used to control raising and lowering of the shutter circuit. The Shutters / blinds function sends the **Up / Down** and **Slat angle / Stop** objects.

Designation	Description	Value
Control on Presence	This parameter is used to define the control emitted after presence detection.	Not used, Up, Down, Stop Default value: Up
Control on absence	This parameter is used to define the control emitted when there is no presence detection.	Not used, Up, Down, Stop Default value: Down

5.7 Priority function

The Priority function sends priority-start or priority-stop controls. The Priority action depends on the type of application controlled: lighting, blinds, heating, etc... The Priority function emits the **Priority** object.

Designation	Description	Value
Control on Presence	This parameter is used to define the control emitted after presence detection.	Not used, Priority ON - Down - Comfort, Priority OFF - Up - Night set-point, ON priority end - Down - Comfort, OFF priority end - Up - Night set-point Default value: OFF priority end - Up - Night set-point
Control on absence	This parameter is used to define the control emitted when there is no presence detection.	Not used, Priority ON - Down - Comfort, Priority OFF - Up - Night set-point, ON priority end - Down - Comfort, OFF priority end - Up - Night set-point Default value: ON priority end - Down - Comfort

5.8 Heating function

This function is used to control a heating circuit according to the presence or absence of people. The Heating function emits the **Heating mode** object.

Designation	Description	Value
Control on Presence	This parameter is used to define the control emitted after presence detection.	Not used, Auto, Comfort, Standby, Night set-point, Frost protection Default value: Auto
Control on absence	This parameter is used to define the control emitted when there is no presence detection.	Not used, Auto, Comfort, Standby, Night set-point, Frost protection Default value: Frost protection

5.9 Heating Activation function

This function is used to activate or deactivate the heating according to the presence or absence of people. The Heating Activation function emits the **Heating activation** object.

Designation	Description	Value
Control on Presence	This parameter is used to define the control emitted after presence detection.	Not used, Heating activation, Heating deactivation Default value: Heating activation
Control on absence	This parameter is used to define the control emitted when there is no presence detection.	Not used, Heating activation, Heating deactivation Default value: Heating deactivation

5.10 Time delay

The lighting time delay is activated when switching from Absence (no movement) to Presence (movement) on the presence channel. The presence sensor returns to Absence mode (no movement) at the end of the time delay whatever the ambiance luminosity level may be. That timer is automatically retriggered after detection. The time delay can be set by the ETS or via the setting potentiometer on the device or with the installer remote control .

Designation	Description	Value
Time delay	Defines the period during which the output switches to ON when a presence is detected. If a presence is detected before the end of the delay, the timer is triggered again (Time delay restarts.)	Potentiometer settings, 5 s, 15 s, 30 s, 1 min, 2 min, 3 min, 4 min, 5 min, 10 min, 15 min, 30 min, 1 h, 2 h, 3 h, 4 h, 8 h Default value: 5 min

5.11 Emission time delay

Designation	Description	Value
Emission time delay	This parameter defers sending the control after detection.	Not active, 1 s, 2 s, 3 s, 5 s, 10 s, 15 s, 20 s, 30 s, 45 s, 60 s, 1 min 15, 1 min 30, 2 min, 2 min 30, 3 min, 5 min, 10 min, 15 min Default value: Not active

5.12 Surveillance sensitivity

This parameter is used to define detection sensitivity. High sensitivity allows the detector to validate presence at the first detection. Low sensitivities define the interval during which 3 detections allow the presence event to be validated.

Designation	Description	Value
Surveillance sensitivity	This parameter defines the sensitivity of detection.	Low sensitivity, High sensitivity (1 detection) Default value: High sensitivity (1 detection)
Low sensitivity*	This setting is used to define the interval during which the detection validates the presence event.	3 detections in 10 seconds, 3 detections in 30 seconds, 3 detections in 1 min, 3 detections in 5 min Default value: 3 detections in 10 seconds

* This parameter is only accessible when surveillance sensitivity is set to Low.

5.13 Emission after initialization

The **Emission after initialisation** parameter defines whether the presence detector sends the current status (depending on the defined function ON/OFF, the scene number or the luminosity) via the Regulation Channel after power is restored. Sending the status can e. g. be helpful when synchronizing a visualization.

Designation	Description	Value
Emission after initialization	This parameter defines whether the input status is sent on the bus upon initialisation.	Emission, Not used Default value: Emission

6. Physical addressing

The detector can be passed into the KNX addressing mode via the local potentiometers or by the aid of the remote control .

Move the potentiometer 2 to "Adr" or use **remote control** (long push > 5 s on the SET key), the red lens behind the lenses is switched-ON to indicate the **addressing mode**.

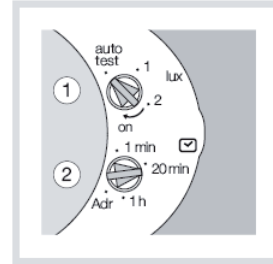
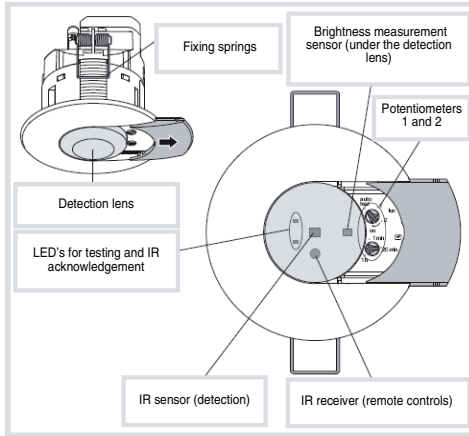

Installer remote control

7. Main characteristics

	7524 10 03
Max. number of group addresses	254
Max. number of links	255

8. Appendix

	Order number	Designation
 <p>The image shows a black remote control with a touch-sensitive interface. At the top, there are icons for home, signal strength, 'Reset', and 'Test'. Below these are four rows of icons: the first row has a sun icon and an eye icon; the second row has a person icon and a chair icon; the third row has minus and plus signs; the fourth row has a wavy line icon and a sun icon. On the left side, there are four timer icons labeled 7', 5', 20', and 30'. At the bottom, there are three buttons: a green 'Memo 1' button, a red 'SET' button, and a yellow 'Memo 2' button.</p>	7590 40 02	Installer remote control
 <p>The image shows a black remote control with a simple interface. At the top, there are two buttons: a green 'on' button and a red 'off' button. Below these are four numbered buttons (1, 2, 3, 4) arranged vertically.</p>	7590 40 01	User remote control

Berker GmbH & Co. KG
Klagebach 38
58579 Schalksmühle/Germany
Telefon + 49 (0) 2355/905-0
Telefax + 49 (0) 2355/905-111
www.berker.de