

Tcn

Système de chambranles

TFN
Perforation du socle

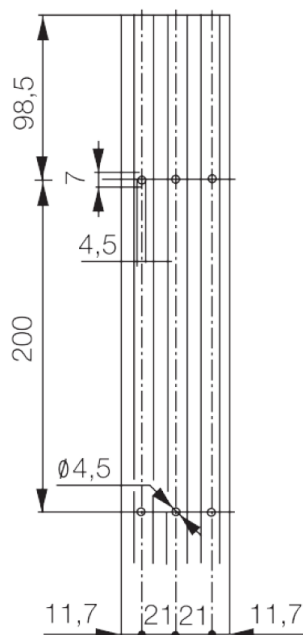

AICN
Angle intérieur variable

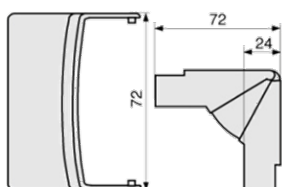

AECN
Angle extérieur variable

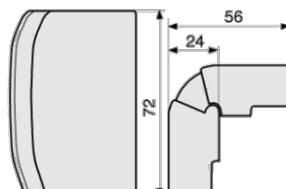

APCN
Angle plat

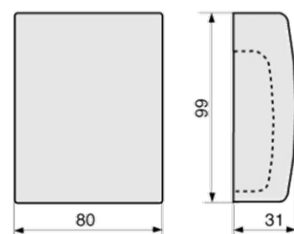

DCN
Dérivation

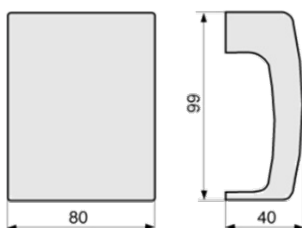

GCN
Joint de couvercle

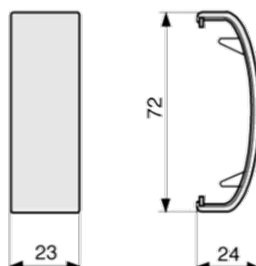

LCN
Embout

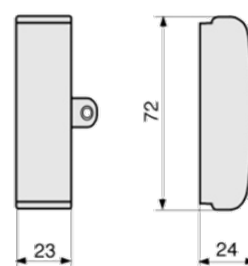

TRBA
Agrafe de retenue de fils

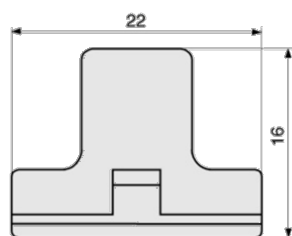

SCN-LM45
Boîtier module 45 (2 modules)

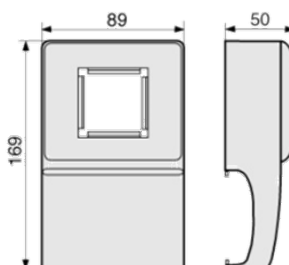

SQCA
Boîtier d'appareillages entraxe 60

