

# hw+

sentinel electronic trip units

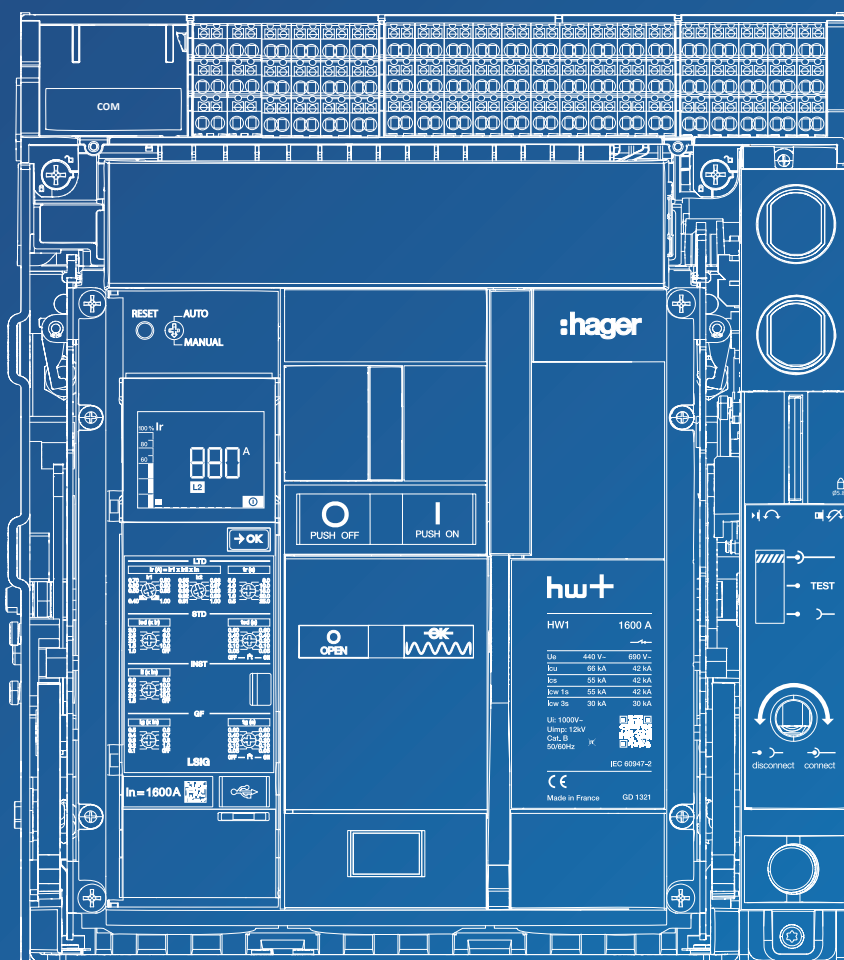

# Contents

Page

---

<b>01 About this manual</b>	<b>3</b>
1.1 Safety instructions	3
1.2 Using this manual	5
<hr/>	
<b>02 sentinel electronic trip unit</b>	<b>6</b>
2.1 Description	6
2.2 Display	8
2.3 LI trip unit	10
2.4 LSI trip unit	11
2.5 LSIG trip unit	12
2.6 Hager Power setup software	13
<hr/>	
<b>03 The types of protection device</b>	<b>15</b>
3.1 Overview of protections	15
3.2 Long time delay protection against overcurrent	16
3.3 Short time delay protection against overcurrent	18
3.4 Instantaneous protection against overcurrent	20
3.5 Earth fault protection	21
3.6 Neutral protection	22
3.7 Zone Selective Interlocking function (ZSI)	23
<hr/>	
<b>04 Protection settings</b>	<b>26</b>
4.1 Principle	26
4.2 Long time delay (LTD) protection setting	32
4.3 Short time delay (STD) protection setting	34
4.4 Instantaneous (INST) protection setting	36
4.5 Adjustment of the earth fault (GF) protection setting	37
4.6 Adjustment of the neutral (N) protection setting	39
4.7 Reviewing the settings	41
<hr/>	
<b>05 Commissioning the circuit breaker</b>	<b>44</b>
<hr/>	
<b>06 Alarm management</b>	<b>45</b>
6.1 PTA overload prealarm	45
6.2 Overload alarm	47
6.3 Trip alarm	48
6.4 System alarm	49
<hr/>	
<b>07 Maintenance indicator</b>	<b>52</b>
<hr/>	
<b>08 Replacing the backup battery</b>	<b>53</b>
<hr/>	
<b>09 Replacement of the rating plug of the electronic trip unit</b>	<b>60</b>

### Warnings and instructions

This documentation contains safety advice which must be respected for your own safety and to prevent property damage.

Safety advice relating to your own safety is identified by a safety warning symbol in the documentation. Safety advice relating to damage to property is identified by "ATTENTION". The safety warning symbols and the wording below are classified according to the risk level.



**DANGER** indicates an imminent dangerous situation which, if not avoided, will result in death or serious injuries.



**WARNING** indicates a potentially dangerous situation which, if not avoided, may result in serious injuries or even death.



**CAUTION** indicates a potentially dangerous situation which, if not avoided, may result in minor or moderate injuries.

### ATTENTION

**ATTENTION** indicates a warning message relating to equipment damage.  
**ATTENTION** also indicates important instructions for use and particularly relevant information regarding the product, which must be respected to ensure effective and safe use.

### **Qualified personnel**

The product or the system described in this documentation must be installed, operated and maintained by qualified personnel only. Hager Electro accepts no responsibility regarding the consequences of this equipment being used by unqualified personnel.

Qualified personnel are those people who have the necessary skills and knowledge for building, operating and installing electrical equipment, and who have received training enabling them to identify and avoid the risks incurred.

### **Appropriate use of Hager products**

Hager products are designed to be used only for the applications described in the catalogues and in the technical documentation relating to them. If products and components from other manufacturers are used, they must be recommended or approved by Hager.

Appropriate use of Hager products during transport, storage, installation, assembly, commissioning, operation and maintenance is required to guarantee problem-free operation in complete safety.

The permissible ambient conditions must be respected. The information contained in the technical documentation must be respected.

### **Publication liability**

The contents of this documentation have been reviewed in order to ensure that the information is correct at the time of publication.

Hager cannot, however, guarantee the accuracy of all the information contained in this documentation. Hager assumes no responsibility for printing errors and any damage they may cause.

Hager reserves the right to make the necessary corrections and modifications to subsequent versions.

**Purpose of the document.**

This manual is designed to provide users, electricians, panel builders and maintenance personnel with the technical information required for the commissioning and operation of hw+ circuit breakers with sentinel electronic trip units.

**Field of application**

This document applies to hw+ circuit breakers with electronic trip units.

**Revisions**

Version	Date
6LE007969A	September 2022

**Documents to consult**

Document	Reference
User manual for hw+ air circuit breakers	6LE007331A
Installation manual for hw+ air circuit breakers	6LE007893A
hw+ user maintenance guide	6LE007897A

You can download these publications and other technical information from our website: [www.hager.com](http://www.hager.com)

**Contact**

Address	Hager Electro SAS 132 Boulevard d'Europe 67215 Obernai France
Phone	+ 33 (0)3 88 49 50 50
Website	<a href="http://www.hager.com">www.hager.com</a>

hw+ air circuit breakers are equipped with a sentinel electronic trip unit on the front to protect against overloads, short circuits and earth faults. It has a display and dials to configure the protection settings and monitor correct operation.

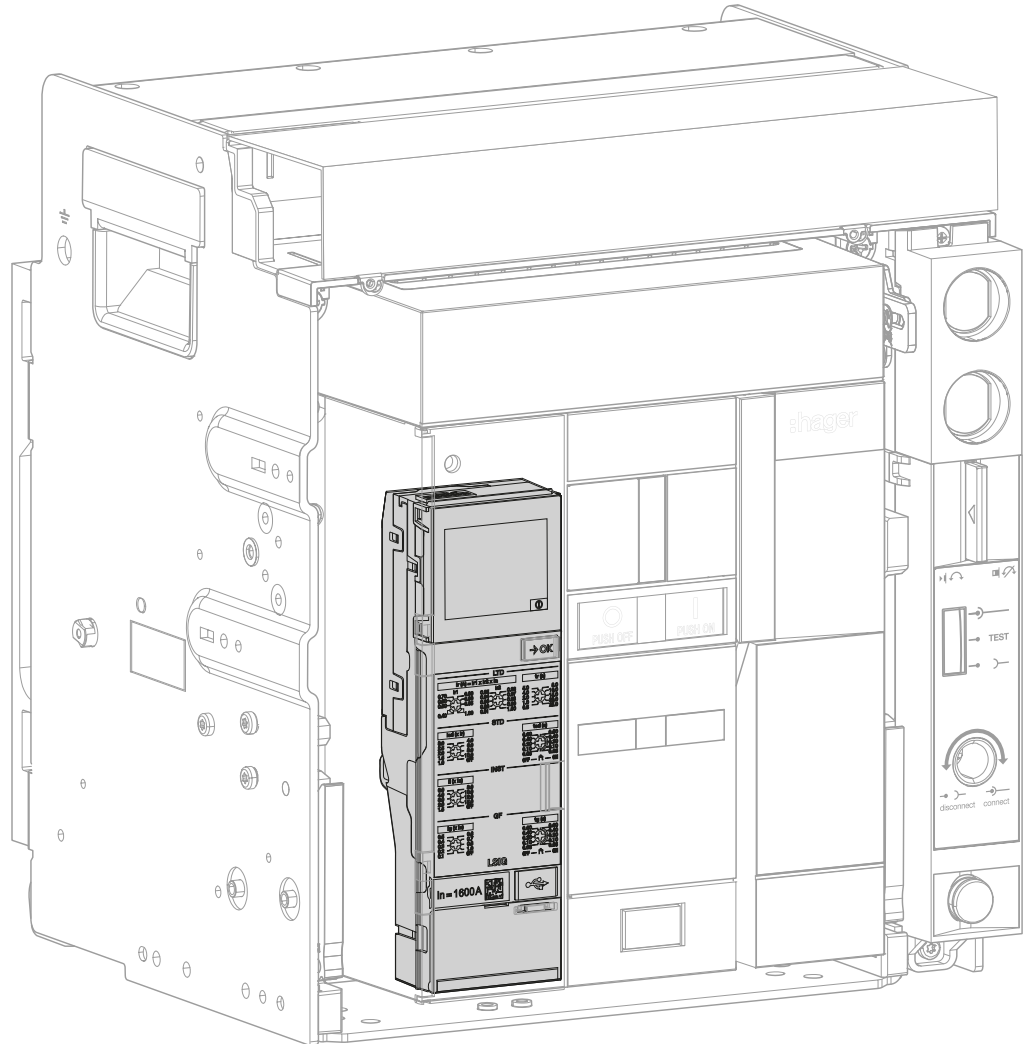

The following characteristics are common to all the versions of the sentinel electronic trip units:

- ① Display
- ② Button **→OK** which can be used to :
  - clear the alarm after the air circuit breaker has tripped,
  - navigate through the display screens.
- ③ Adjustment dials of the sentinel electronic trip unit.
- ④ Rated current value  $I_n$  of the air circuit breaker. This value is provided by the rating plug installed on the electronic trip unit.
- ⑤ USB-C port to connect an external battery. This USB-C port also allows connection to a computer equipped with the **Hager Power setup** commissioning software (see Chapter 4.1 Principle).
- ⑥ Backup battery powering the display after electrical tripping.
- ⑦ Backup battery housing cover.

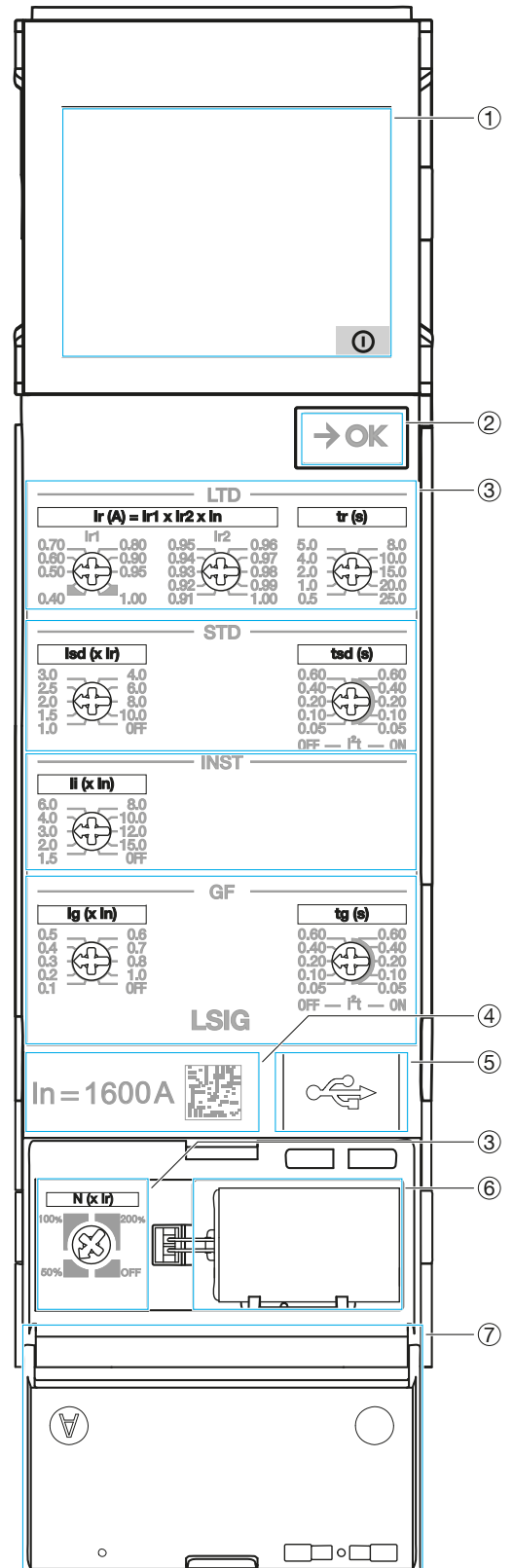

### ATTENTION

To guarantee that the electronic trip unit functions well, it is recommended that a 24V DC SELV external power supply be connected (recommended product reference Hager HTG911H) to the TU terminal block.

Without this external power supply, the electronic trip unit requires the presence of a minimum current of 120 A on one phase or 80 A per phase to provide its protection functions.

### Description of the display

sentinel electronic trip units are equipped with a display that makes it easy to adjust and read the causes of tripping of the hw+ circuit breakers.

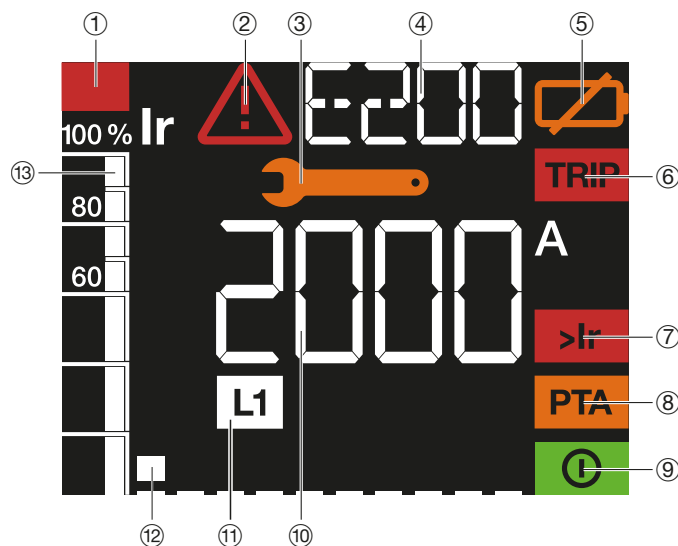

- ① **Overload indicator:** displayed as soon as the current exceeds 105% of  $I_r$ .
  - ② **Error indicator:** displayed when an error is detected.
  - ③ **Maintenance indicator:** displayed when a maintenance intervention is required.
  - ④ **Text display area:** displays the name of the protection parameter during adjustment or after a trip in addition to the error codes of non-critical system alarms.
  - ⑤ **Low or missing battery indicator:** displayed if the electronic trip unit backup battery needs changing or is not connected.
  - ⑥ **Trip indicator:** together with the digital display zone, the text display zone and the phase display, enables the cause of the tripping to be precisely determined.
  - ⑦ **Overload indicator:** flashes as soon as the current exceeds 105% of  $I_r$  and is lit and steady above 112.5%  $I_r$
  - ⑧ **Overload pre-alarm indicator:** warns of an imminent tripping risk.
  - ⑨ **ReadyToProtect indicator:** displayed when the electronic trip unit is operational and ready to protect.
  - ⑩ **Numerical display zone:** used to display the values of the various settings and what the tripping value was, using the following units.
 

A	Ampere
Å	Peak current
S	Second
$I^2t$	$I^2t$ curve
- Also displays the codes of the critical system alarms.
- ⑪ **Phase display:** Neutral on the left / Phase L1 / Phase L2 / Phase L3.
  - ⑫ **Reference screen:** shows the number of screens in the electronic trip unit as well as its position in the display order.
  - ⑬ **Bargraph:** used to view the currents read on the most highly loaded phase L1, L2 or L3 as a percentage of the  $I_r$  setting.



In standby, the ReadyToProtect indicator flashes, indicating normal operation of the sentinel electronic trip unit.



A short press of the button **→OK** displays a 1<sup>st</sup> screen showing the highest current of the 3 phases flowing through the circuit breaker.

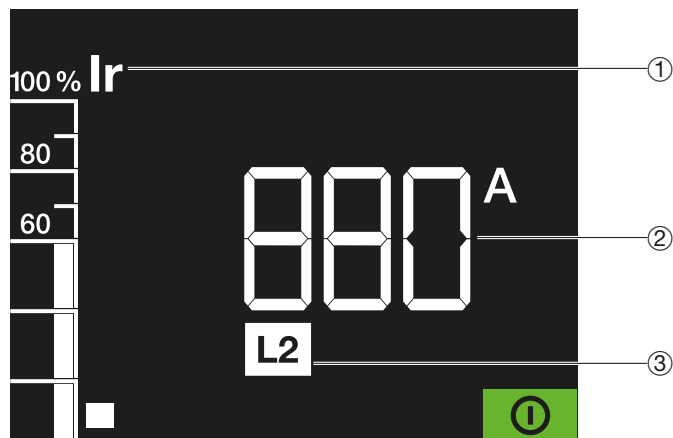

- ① Current flowing through the circuit breaker in % of  $I_r$ .
- ② Value in amps of the current flowing through the circuit breaker on the most highly loaded phase.
- ③ Relevant phase.

The sentinel electronic trip unit is available in 3 versions: **LI**, **LSI** and **LSIG**

**LI sentinel trip unit**

The LI sentinel trip unit is used to protect long cable lines where the rated fault current is limited due to the impedance of the cable.

The dials are accessible from the front of the sentinel electronic trip unit, allowing precise adjustment of the protection parameter settings. The protection adjusted in this way is independent of the ambient temperature.

- ① LTD Long time delay protection setting
- ② INST Instantaneous protection setting
- ③ Neutral N protection setting

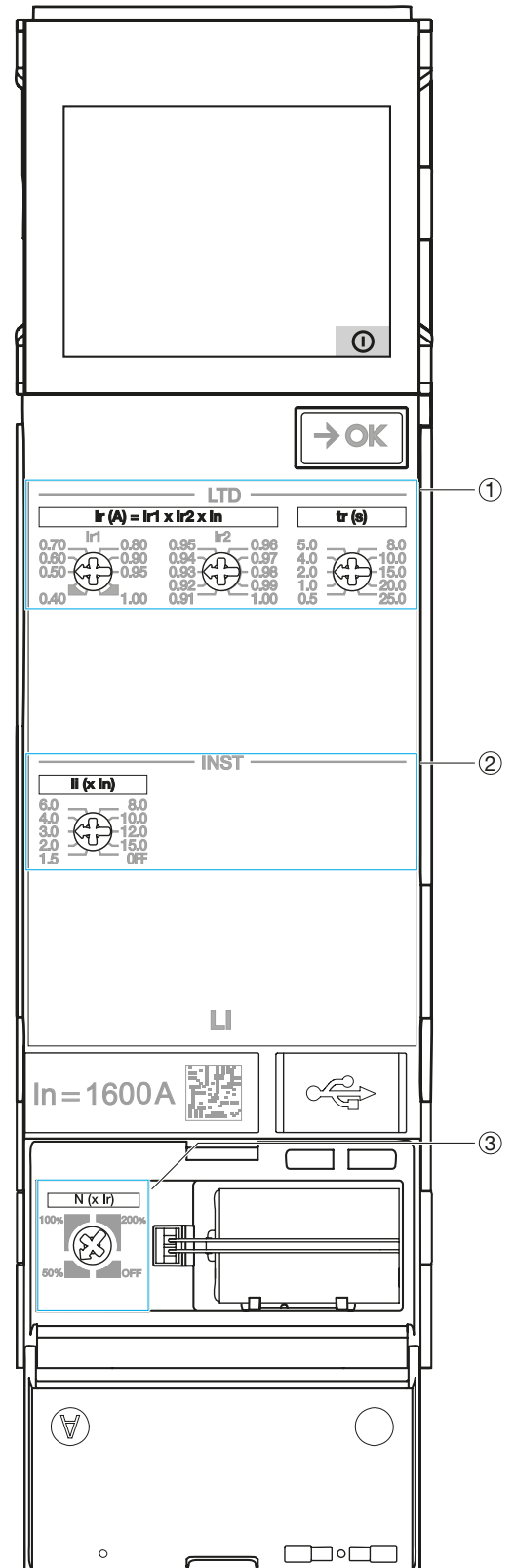

**LSI sentinel trip unit**

The LSI sentinel trip unit is used to protect cables lines and equipment requiring a wide variety of protection settings.

The dials are accessible from the front of the sentinel electronic trip unit, allowing precise adjustment of the protection parameter settings. The protection adjusted in this way is independent of the ambient temperature.

- ① LTD Long time delay protection setting
- ② STD Short time delay protection setting
- ③ INST Instantaneous protection setting
- ④ N neutral protection setting adjustment

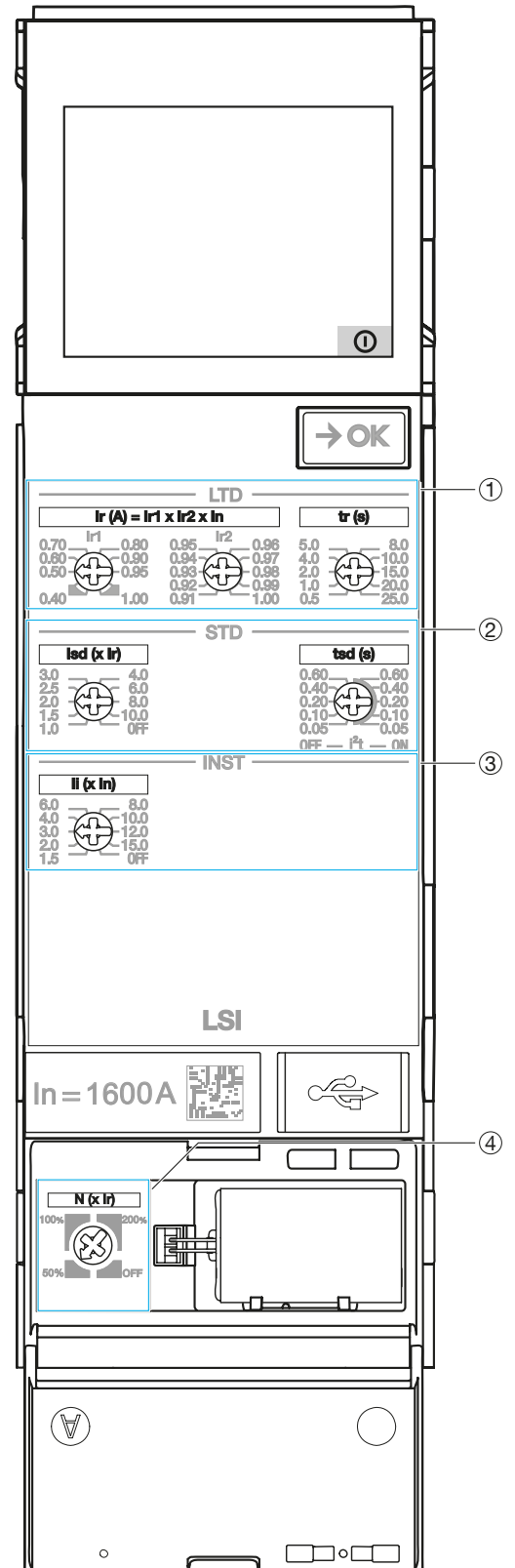

**LSIG sentinel trip unit**

The LSIG sentinel trip unit is used to protect cable lines and equipment for the case of a coupling system to TN earth or protection against earth faults is required.

The dials are accessible from the front of the sentinel electronic trip unit, allowing precise adjustment of the protection parameter settings. The protection adjusted in this way is independent of the ambient temperature.

- ① LTD Long time delay protection setting
- ② STD Short time delay protection setting
- ③ INST Instantaneous protection setting
- ④ GF earth fault protection setting
- ⑤ N neutral protection setting adjustment

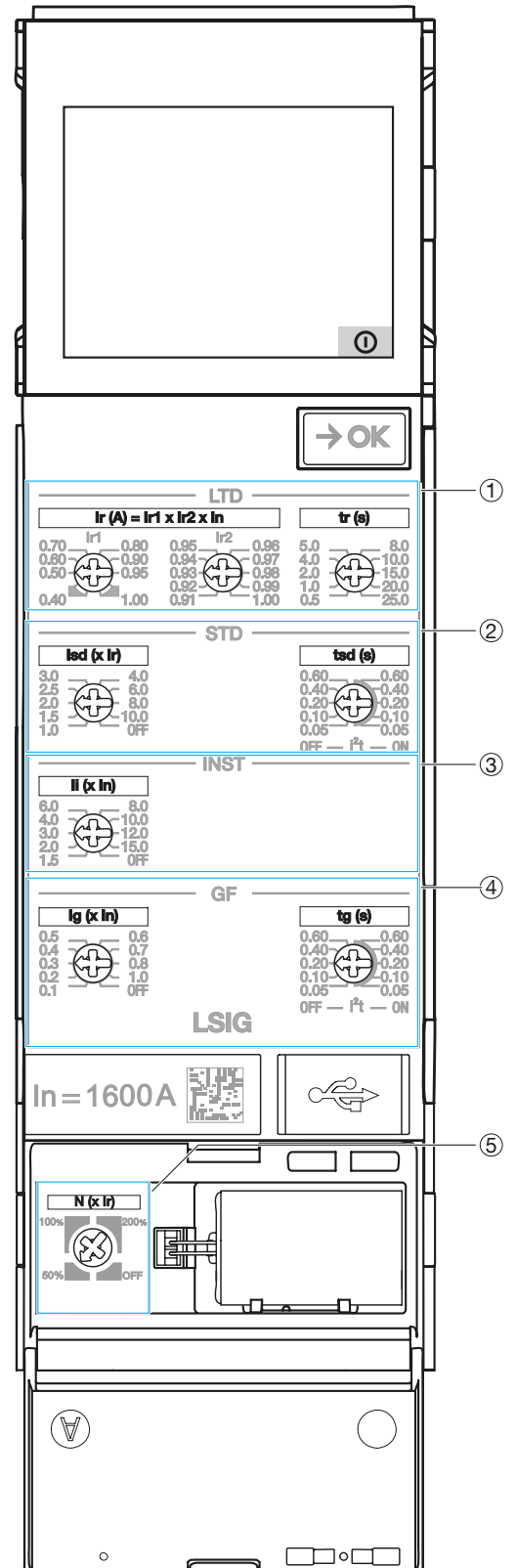

The Hager Power setup software has been designed for testing and commissioning hw+ trip units.

Thanks to the commissioning menu, it is possible to specifically generate a commissioning report proving that the protection settings comply with the short-circuit and selectivity calculations. This requires the settings to be imported from the Hagercad software.

It offers a smart way of creating the protection settings. It also allows all the trip unit parameter settings to be displayed and modified.

It is possible to perform a test of the hw+ circuit breakers tripping curve.

It also allows a forced electro-mechanical tripping of the circuit breakers to be performed.

It is very useful during the test phase when wiring the output contacts. It makes it possible to force the opening or closing of the OAC and ZSI output contacts.

The result of the different tests can be entered into a test report that can be generated at any time whether in the wiring workshop or during acceptance tests on site.

The functions of the Hager Power setup software can be accessed through five menus:

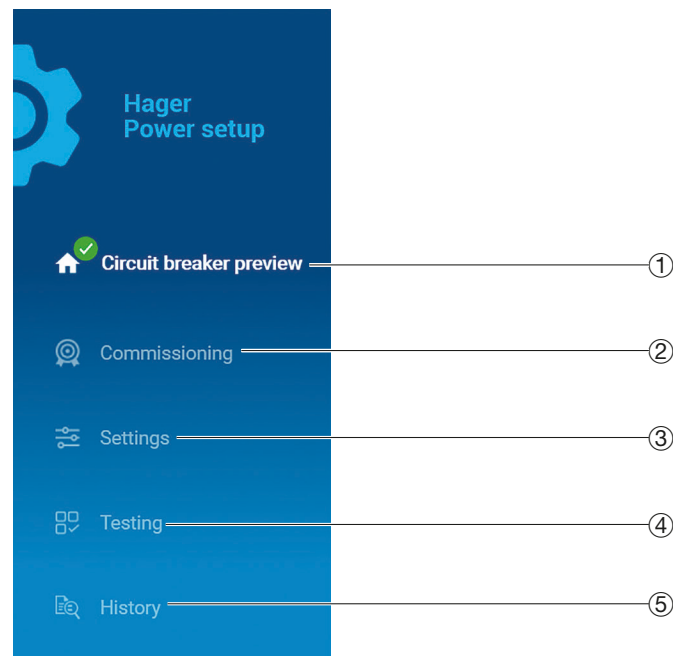

- ① Functional state of the circuit breaker, maintenance information and principal technical characteristics.
- ② Three-stage procedure 1. Adjustment, 2. Test, 3. Tripping to commission the circuit breaker using settings data imported from the Hagercad software. Allows a commissioning report to be generated.
- ③ Access to all the parameter settings of the trip unit.
- ④ Access to the tripping curve of the manual test, the forced electro-mechanical tripping and activation of the output contacts available on the circuit breaker. Allows a test report to be generated.
- ⑤ Access to event history.  
Display of active alarms.  
Operating counters panel.

### Principal functions

- Display the functional state of the circuit breaker, maintenance information and principal technical characteristics.
- Perform a commissioning or enter assisted settings by importing settings from Hagercad.
- Generate and print test reports and commissioning reports.
- Perform a manual test of the tripping curve of the hw+ circuit breakers.
- Perform a forced electro-mechanical tripping of the circuit breakers.
- Display and modify all the electronic trip unit parameter settings.
- Display alarms in progress.
- Download and export the electronic trip unit settings in a file in CSV format.
- Save the settings of a circuit breaker from within the Energy range to load them into one or more similar circuit breakers.
- Force the opening or closing of the OAC and ZSI output contacts.
- Display the active alarms.
- View the event logs and export them in a file in CSV format.
- Display the status of the operating counters available (handling cycles, tripping operations...).

The Hager Power setup software is available on the Hager website for your country.

### IT configuration required

	Minimal	Recommended
<b>Operating system</b>	Windows 10 x32 bits	Windows 10 x64 bits
<b>Memory</b>	4 Gb RAM	8 Gb RAM
<b>Disk space</b>	50 Mb	50 Mb
<b>Components</b>	Microsoft .NET Framework 4.7.2 .NET Core Runtime 3.1.13 .NET Desktop Runtime 3.1.13 Microsoft web view 2 v1.0.818.14	Microsoft .NET Framework 4.7.2 or higher .NET Core Runtime 3.1.13 or higher .NET Desktop Runtime 3.1.13 or higher Microsoft web view 2 v1.0.818.14 or higher
<b>Resolution</b>	1024x768 pixels	1280x1024 pixels

The sentinel electronic trip unit protects against overcurrent and earth faults for all types of electrical distribution in accordance with the requirements of standards IEC 60947-1 and 60947-2.

**Protection system**

- Long delay against overcurrent - **L**: Overload protection
- Short delay against overcurrent - **S**: Protection against low current short circuits
- Instantaneous against overcurrent - **I**: Protection against high current short circuits
- earth fault - **G**: Phase-to-earth fault protection
- Neutral - **N**: Protection against overloads and short circuits which may flow through and damage the neutral conductors.

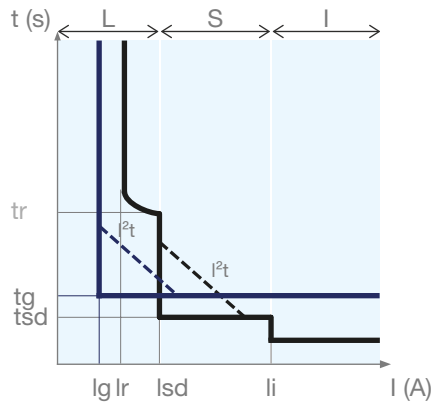

<b>L</b>	Ir	Long time delay protection threshold against overcurrent
	tr	Long time delay against overcurrent
<b>S</b>	Isd	Short time delay protection threshold against overcurrent
	tsd	Short time delay against overcurrent
	I²t ON/OFF	Short time delay protection I²t curve against overcurrent (activated/deactivated)
<b>I</b>	li	Instantaneous protection threshold against overcurrent
<b>G</b>	Ig	earth protection threshold
	tg	earth protection time delay
	I²t ON/OFF	earth protection I²t curve (activated/deactivated)
<b>N</b>	N	Threshold as % of the value of the neutral protection setting (adjustment of the Ir and Isd thresholds)

Protection according to ANSI	Code
<b>L</b>	ANSI 49
<b>S</b>	ANSI 50TD/51
<b>I</b>	ANSI 50
<b>G</b>	ANSI 50N TD/51N

In addition to Instantaneous protection, all sentinel electronic trip units include MCR protection (Making Current Release). This guarantees immediate tripping of the hw+ circuit breakers in cases of closing operation on a short-circuit.

**Adjusting the protection**

The protection settings can be modified using the dials and the display. All protection functions are based on the root-mean-square value (RMS) of the current to take into account the presence of current harmonics. The extensive choice of protection curve settings facilitates coordination in terms of selectivity.

The Long time delay protection is designed to protect the cables, the busbars and the busbar sheaths from current overloads. It includes a thermal memory function that temporarily stores the calculated thermal values so that the thermal effect of the cable heating remains available. The phases and the neutral pole benefit independently from the Long time delay protection. It can also be used to protect transformers or generators.

### Long time delay protection curve

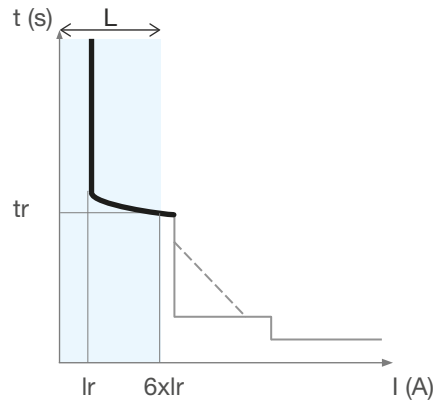

Long time protection

### Long time delay parameters

<b>L</b>	$I_r = I_{r1} \times I_{r2} \times I_n$ (A)	Long time delay protection threshold against overcurrent
	$t_r$ (s)	Long time delay against overcurrent

### Adjusting the $I_r$ current setting

The Long Time Delay protection tripping range is: 1.05 - 1.20  $I_r$ .  
The  $I_r$  current setting is adjusted using the 2 dials  $I_{r1}$  and  $I_{r2}$ .

Rating (In)	Pick up adjustment range $I_r = I_{r1} \times I_{r2} \times I_n$ (A)
<b>400 A</b>	145.6 - 400 A
<b>630 A</b>	229.3 - 630 A
<b>800 A</b>	291.2 - 800 A
<b>1000 A</b>	364 - 1000 A
<b>1250 A</b>	455 - 1250 A
<b>1600 A</b>	582.4 - 1600 A

### Adjusting the $t_r$ time delay

The  $t_r$  time delay defines the trigger time of the long time delay protection for a current of 6 x  $I_r$ .  
The  $t_r$  time delay is adjusted using the  $t_r$  dial.



**tr adjustment range (s)**

0.5	1.0	2.0	4.0	5.0	8.0	10.0	15.0	20.0	25.0
-----	-----	-----	-----	-----	-----	------	------	------	------

The trigger time tolerance for the long time delay protection is from 0 % to -20 %.

Example: for  $t_r = 5\text{ s}$  and  $I = 6 \times I_r$ , the tripping time for the long time delay protection will be between 3.98 s and 5.03 s.

**Thermal image**

Closing operation at a high load, successive starts of the motor or a fluctuating load, results in current pulses similar to repetitive faults, which have a thermal effect on the conductors. The cumulative effect of these successive current pulses will result in excessive heating of the conductors.

Traditional Long time delay protection is not able to protect the conductors against repetitive faults of this kind because the duration of each detected overload is too short to cause effective tripping.

Thanks to its thermal memory and imaging function, the sentinel electronic trip unit memorizes and integrates the thermal effects of the detected overloads whatever the current value. These functions are guaranteed even if the trip unit is not powered by an external power supply. This reduces the associated Long time delay time to cause effective tripping before the conductors overheat.

The thermal memory and image function of the sentinel trip unit provides optimal protection of the cables and busbars against overheating.

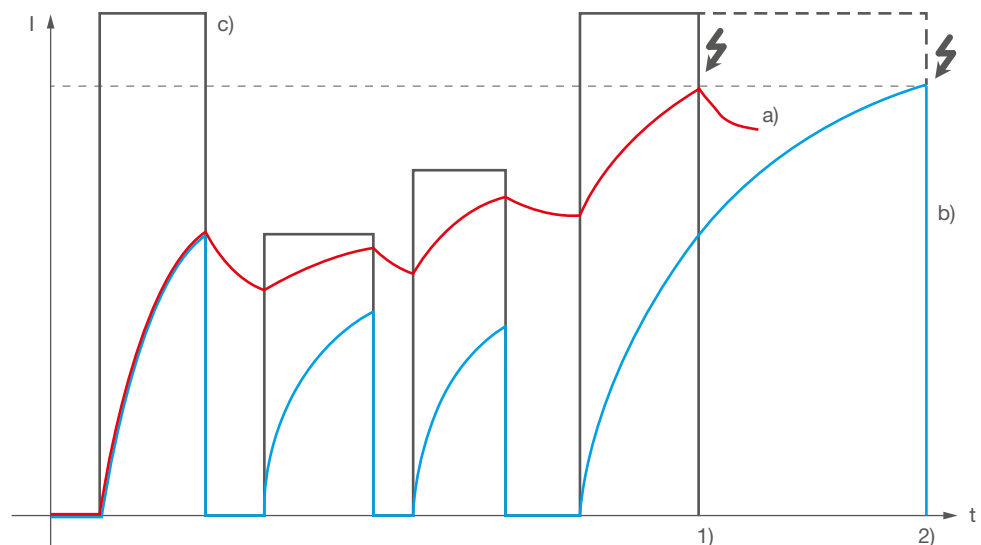

Tripping with and without thermal imaging

Key:

- a) Calculation with thermal memory
- b) Calculation without thermal memory
- c) Current in the load
- 1) Tripping case a)
- 2) Tripping case b)

The example above clearly shows that the trip unit a) with thermal memory trips earlier and thus protects the conductors better than trip unit b) without thermal memory.

**Note:** The thermal memory and imaging function of the sentinel electronic trip units cannot be deactivated.

Short time delay protection is designed to protect against short circuits.

### Short time delay protection curve

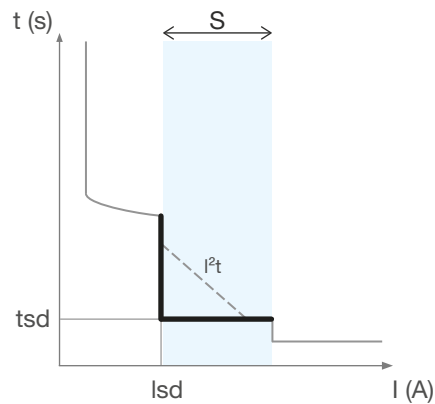

Short time delay protection

### Short time delay parameters

<b>S</b>	$I_{sd} \times I_r$	Short time delay protection threshold against overcurrent
	$t_{sd}$ (s)	Short time delay against overcurrent
	$I^2t$ (ON/OFF)	Short time delay protection $I^2t$ curve against overcurrent

### Adjusting the $I_{sd}$ pick-up setting

The  $I_{sd}$  pick-up is adjusted using the  $I_{sd}$  dial.

#### $I_{sd}$ pick-up adjustment range ( $\times I_r$ )

OFF	1.0	1.5	2.0	2.5	3.0	4.0	6.0	8.0	10.0
-----	-----	-----	-----	-----	-----	-----	-----	-----	------

When the  $I_{sd}$  setting is OFF, the short time delay protection is deactivated.

The  $I_{sd}$  tripping tolerance threshold for short time delay protection is  $\pm 10\%$ .

### Adjusting the $t_{sd}$ time delay

The  $t_{sd}$  time delay is adjusted using the  $t_{sd}$  dial.

<b><math>t_{sd}</math> adjustment range (s)</b>	0.05	0.10	0.20	0.40	0.60
<b>Non-tripping time (s)</b>	0.025	0.075	0.175	0.375	0.575
<b>Maximum tripping time (s)</b>	0.1	0.15	0.25	0.45	0.65
<b>Maximum breaking time (s)</b>	0.12	0.17	0.27	0.47	0.67

An inverse time function  $I^2t=K$  can be activated or deactivated when adjusting the short time delay.

This  $I^2t$  function makes it possible to improve selectivity with downstream devices. It is activated from the  $I_{sd}$  pick-up and functions up to  $10xI_r$ .

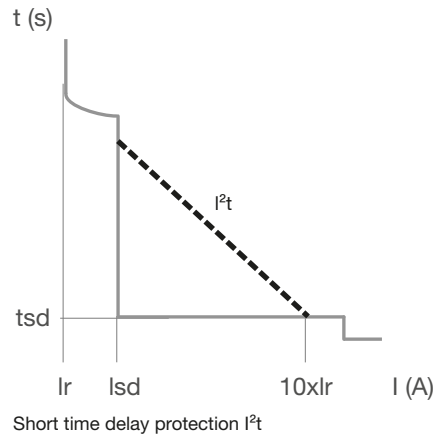

Instantaneous protection is designed to protect against high short circuit currents. This protection is time-independent.

**Instantaneous protection curve**

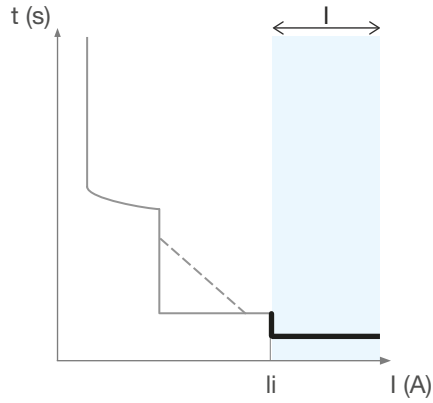

Instantaneous protection

**Instantaneous protection parameters**

<b>I</b>	li (x In)	Instantaneous protection threshold against overcurrent
----------	-----------	--

**Adjusting the li pick-up setting**

The li pick-up is adjusted using the li dial.

**li pick-up adjustment range (x In)**

OFF	1.5	2.0	3.0	4.0	6.0	8.0	10.0	12.0	15.0
-----	-----	-----	-----	-----	-----	-----	------	------	------

The li pick-up tolerance for instantaneous protection is ±10%.

**Tripping time**

Instantaneous protection has no adjustable time delay.

The non-tripping time is 20 ms.

The maximum breaking time is 70 ms.

The earth fault protection is used against phase-to-earth faults. The earth fault currents can reach a high enough amplitude that they are similar to a short circuit. It is based on the calculation of the sum of the phases and the neutral current.

**Earth fault protection curve**

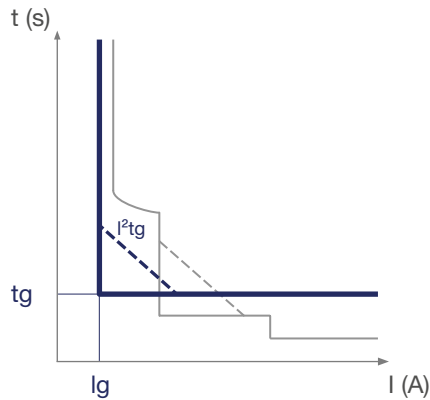

Earth fault protection

**Instantaneous protection parameters**

<b>G</b>	$I_g$ (xIn)	Earth fault protection threshold
	$t_g$ (s)	Earth fault protection time delay
	$I^2 t_g$ (ON / OFF)	Earth fault $I^2 t$ protection curve

**Adjusting the  $I_g$  pick-up setting**

The  $I_g$  pick-up is adjusted using the  $I_g$  dial.

**$I_g$  pick-up adjustment range (x In)**

OFF	0.1	0.2	0.3	0.4	0.5	0.6	0.7	0.8	1.0
-----	-----	-----	-----	-----	-----	-----	-----	-----	-----

When the  $I_g$  pick-up is set to OFF, earth fault protection is deactivated.

**Adjusting the  $t_g$  time delay**

The  $t_g$  time delay is adjusted using the  $t_g$  dial.

<b><math>t_g</math> time delay adjustment range (s)</b>	0.05	0.10	0.20	0.40	0.60
<b>Non-tripping time (s)</b>	0.025	0.075	0.175	0.375	0.575
<b>Maximum tripping time (s)</b>	0.1	0.15	0.25	0.45	0.65
<b>Maximum breaking time (s)</b>	0.12	0.17	0.27	0.47	0.67

The  $I^2 t$  earth protection curve improves the selectivity of the earth faults with circuit breakers located upstream. This protection functions from the value of the  $I_r$  setting to the nominal value  $I_n$ . It can be adjusted using the  $t_g$  dial.

<b>ATTENTION</b>	
<p>In the case of a 3-pole product, the earth fault protection is dependant on the neutral protection setting and on the presence of an ENCT external neutral sensor. If an ENCT external neutral sensor is used, it is necessary to activate the neutral protection to take into account the sum of the phases and the neutral current.</p>	

Neutral protection is factory-installed on 4P circuit breakers and as an option with the addition of the ENCT external neutral sensor on 3P versions. It is particularly useful if the neutral conductor section is less than that of the phases, or if the neutral conductor is heavily loaded (for example, in office buildings).

It uses the long time delay, short time delay and instantaneous protection parameters.

### Neutral protection curve

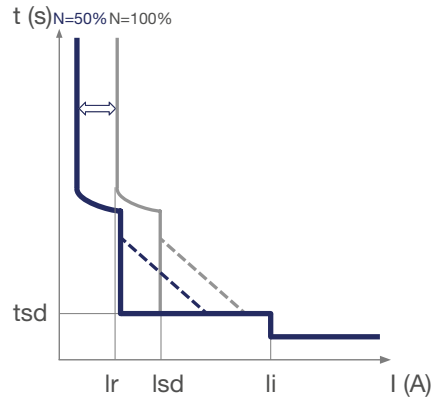

Neutral protection

### Adjusting the Ir and Isd neutral protection thresholds

N coefficient adjustment range (%)	Parameters impacted
OFF - 50 - 100 - 200	The percentage is applied to the adjustment value of the Ir and Isd thresholds for the phases.

For a setting at 200%, the maximum value of the neutral protection cannot exceed the maximum rating of the circuit breaker.

For example for a HW1 circuit breaker (maximum rating 1600 A) with an Ir setting at 1000 A and a neutral protection setting at 200 %, the Ir neutral threshold value will be limited to 1600 A.

The li (Instantaneous protection) remains identical to that of the phases.

The N coefficient is adjusted using the N dial.

On a 3-pole product, if there is no ENCT external neutral sensor:

- it is advised to keep the setting of the N encoder dial to OFF (factory setting by default),
- if the N dial is set to 50 %, 100 % or 200%, the protection will remain inactive.

### Neutral protection time delay

The time delays for neutral protection remain identical to the phase time delay adjustment values.

The Zone Selective Interlocking (ZSI) function is designed to limit the electro-dynamic constraints on the installation (devices, conductors and busbars) in case of a short circuit fault or earth fault.

It reduces the time taken to clear the electrical fault while maintaining the selectivity and coordination provided by the protection settings.

The installed circuit breakers are linked together by cable to determine which circuit breaker should trip first. If an electrical fault appears between two linked circuit breakers, the downstream circuit breaker is unable to eliminate it. Thanks to zone selectivity, the circuit breaker upstream of the fault trips without waiting till the end of its time delay.

For zone selectivity to work correctly, the ZSI terminals of all circuit breakers must be wired together among themselves. The tripping time delay of each circuit breaker must be adjusted according to the chronometric sensitivity desired and the ZSI function must be activated (only on circuit breakers linked to their downstream circuit breakers).

The ZSI function supports the Short Time Delay protection (ZSI STD) and the Earth Fault protection (ZSI GF).

Here are two examples to explain the functioning.

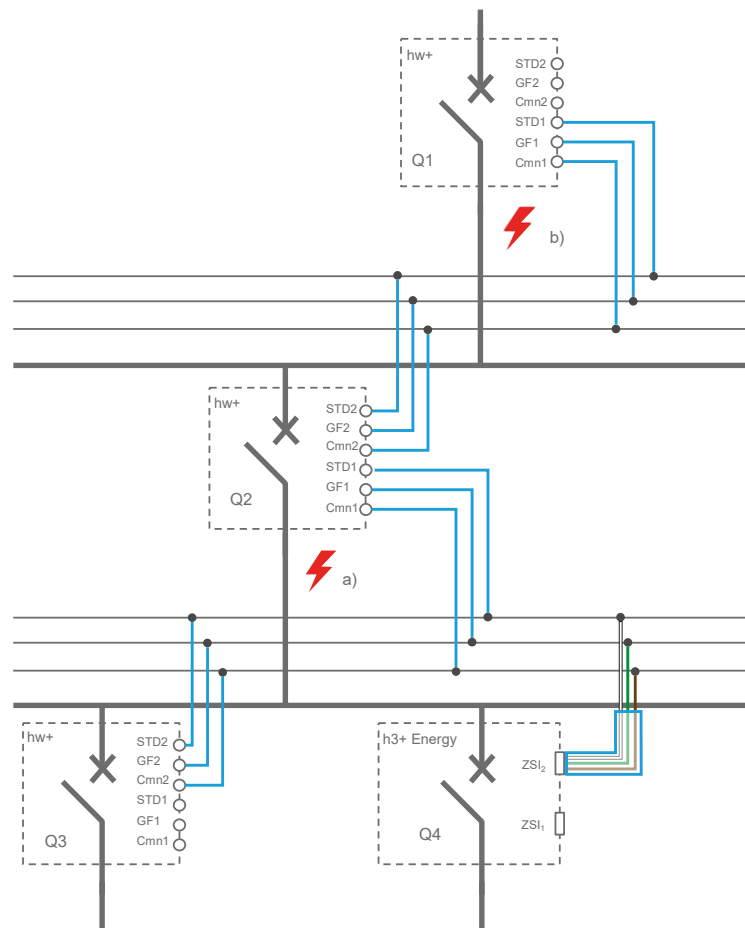

Zone selectivity: Example

First, circuit breakers Q1, Q2, Q3, Q4 are set to their respective thresholds enabling the expected time selectivity to be activated. The ZSI function must be activated only on the Q1 and Q2 circuit breakers.

Fault example a):

- If a fault occurs at point a), the Q1 and Q2 circuit breakers detect the electrical fault. Thanks to the ZSI cabling (in blue), the Q1 circuit breaker receives a signal from Q2 and remains closed to allow the Q2 circuit breaker to eliminate the fault. The Q2 circuit breaker does not receive a signal either from Q3 or Q4. It opens immediately, despite the previously set tripping time delay.

Fault example b):

- If a fault occurs at point b), the Q1 circuit breaker detects the electrical fault. The Q1 circuit breaker does not receive a signal from Q2, it opens immediately, despite the previously set tripping time delay.

### Adjusting the ZSI protection setting

To take into account zone selectivity, the ZSI protection must be activated on the hw+ circuit breakers using the **Hager Power setup** commissioning and test software.

### ZSI protection settings

Short time delay protection ZSI	ON-OFF (OFF by default)
Earth fault protection ZSI	ON-OFF (OFF by default)

### Connection of ZSI protection

hw+ air circuit breakers have 6 ZSI terminal blocks enabling the upstream or downstream circuit breakers to be connected to deploy zone selectivity (ZSI).

Type of connection	Total number of circuit breakers	Max. distance between 2 circuit breakers
Upstream	3	300 m
Downstream	7	300 m

Recommended connection cable: 1 to 1.5 mm<sup>2</sup> twisted pair.

**Note:** it is important to keep the ZSI protection deactivated on an hw+ circuit breaker not connected to its downstream circuit breakers (ZSI STD1, GF1, Cmn1 terminals not used). If it is activated, the circuit breaker will immediately trip when an electrical fault occurs without waiting till the end of the short time delay and the earth fault protection time delay.



drawout circuit breaker

	TU		ZSI		
S1	-	24 V +	STD1	STD2	LTD
S2	2	CIP 1	GF1	GF2	STD/ INST
	-	RR/DI +	Cmn1	Cmn2	DOC

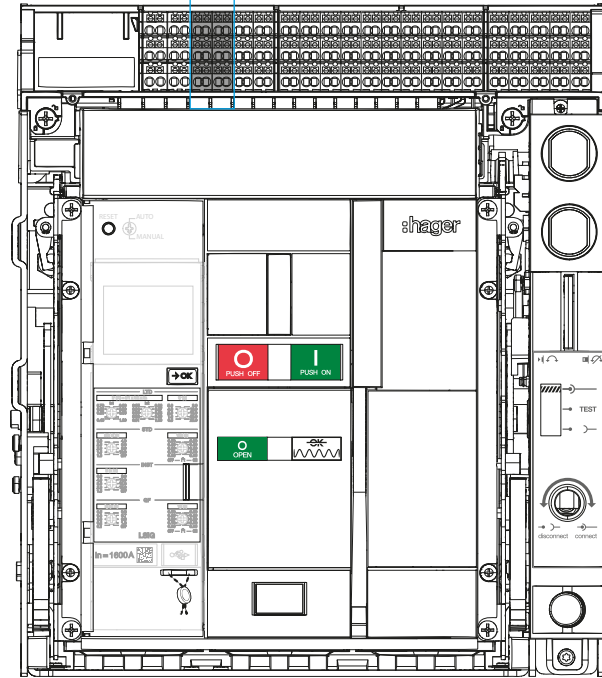

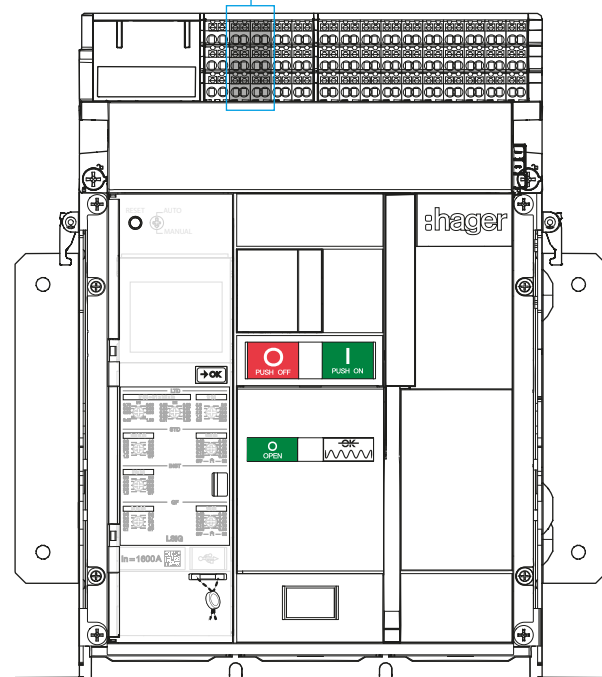

Fixed circuit breaker

	TU		ZSI		
S1	-	24 V +	STD1	STD2	LTD
S2	2	CIP 1	GF1	GF2	S/I
	-	RR/DI +	Cmn1	Cmn2	DOC

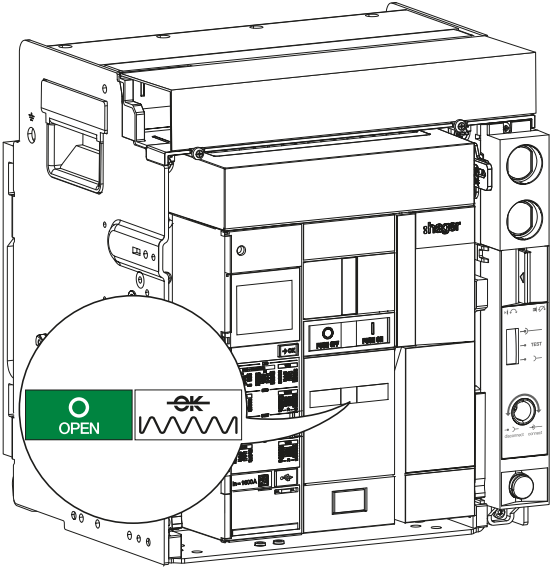

Follow the procedure below to adjust the protection devices.

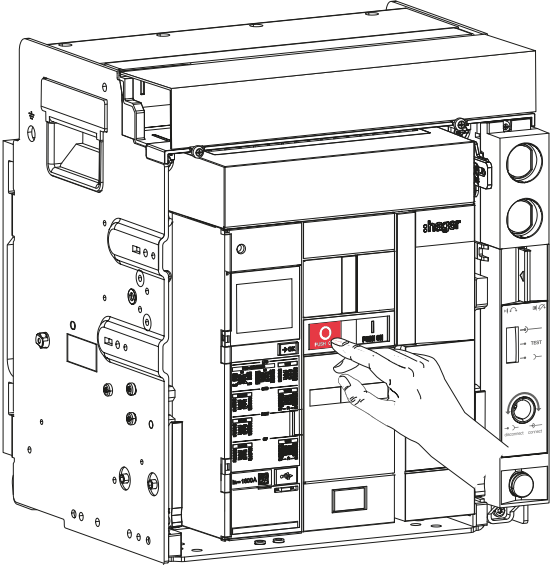
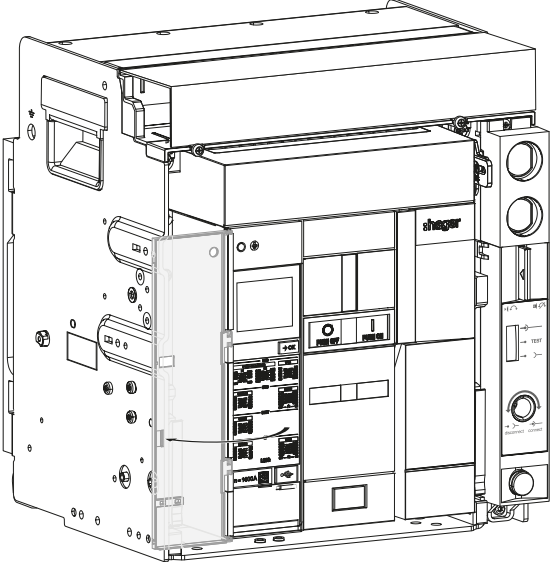
	Action	Illustration
1	<p>First, ensure that the circuit breaker is switched off and displays the following information:</p>	 <p>The illustration shows a Hager circuit breaker with its front door open. A circular callout highlights the status display area, which shows a green 'O' symbol and the word 'OPEN' on the left, and an 'OK' symbol and a sine wave on the right.</p>
2	<p>If this is not the case, open the circuit breaker by pressing the opening push button</p> 	 <p>The illustration shows a hand pressing the red square button with a white circle and 'PUSH OFF' text, located on the front panel of the circuit breaker.</p>
3	<p>Open the transparent cover protecting access to the electronic trip unit.</p>	 <p>The illustration shows the transparent cover on the front panel of the circuit breaker being swung open to the left, revealing the internal electronic trip unit.</p>

	Action	Illustration
4	Adjust as required using the dials.	
5	The electronic trip unit must be powered in order to show the settings on the display. If necessary, remove the USB-C port cover to connect an external battery.	
6	Connect the external battery to the electronic trip unit's USB-C port.	
7	Check that the trip unit display switches on.	

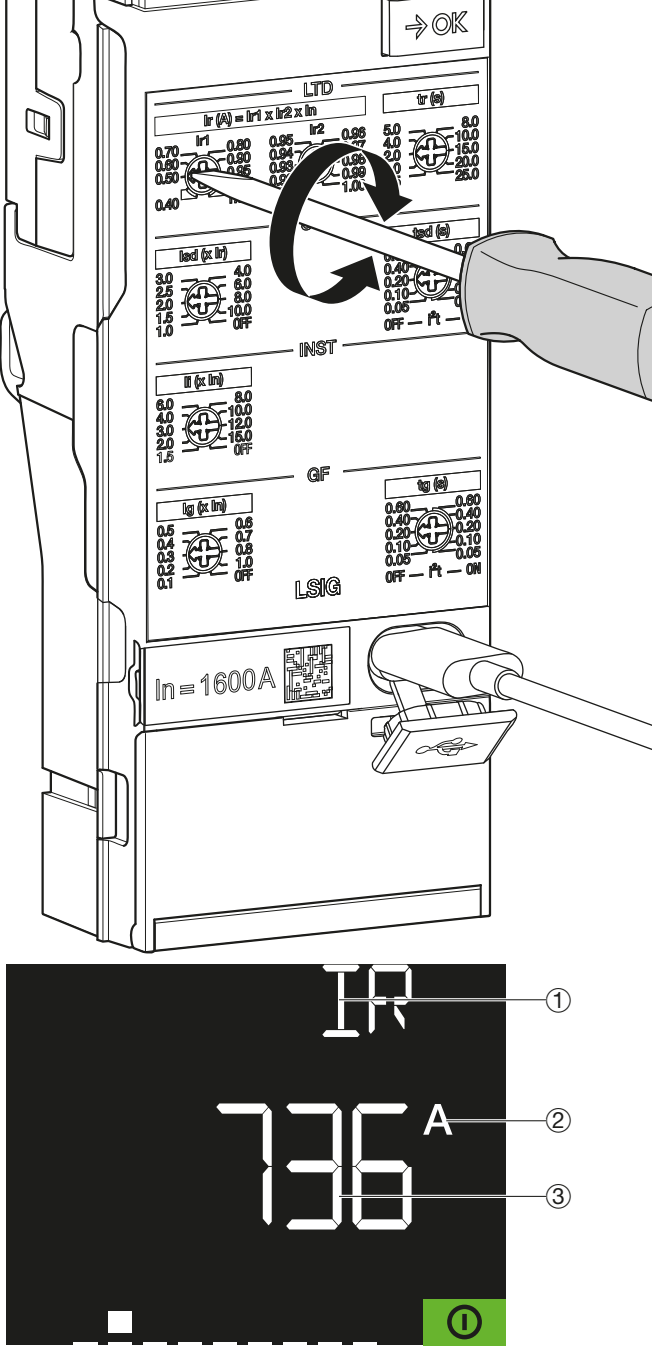
	Action	Illustration
8	<p>Now, with each movement of the dial, show the corresponding setting...</p> <p>... on the display to avoid converting the dial coefficients in your head into amps or seconds.</p>	 <p>① Parameter adjusted</p> <p>② Parameter unit: - in amps (A) for currents, - in seconds (S) for time delays.</p> <p>③ Parameter value</p>

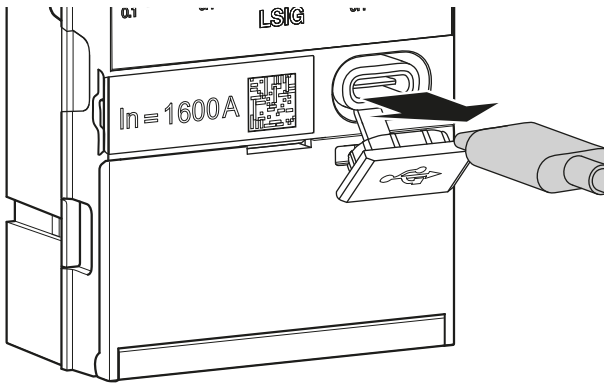
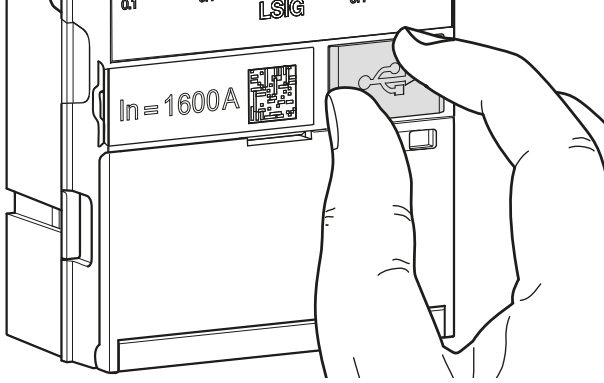
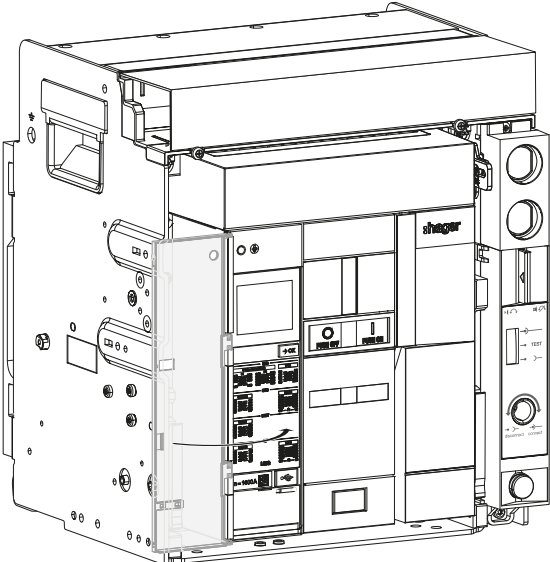
	Action	Illustration
9	<p>Check that if no action is performed for 30 seconds, the display returns to its standby screen.</p>	
10	<p>Once all the settings have been adjusted, disconnect the external battery.</p>	
11	<p>Close the USB-C port cover.</p>	
12	<p>Close the transparent cover.</p>	

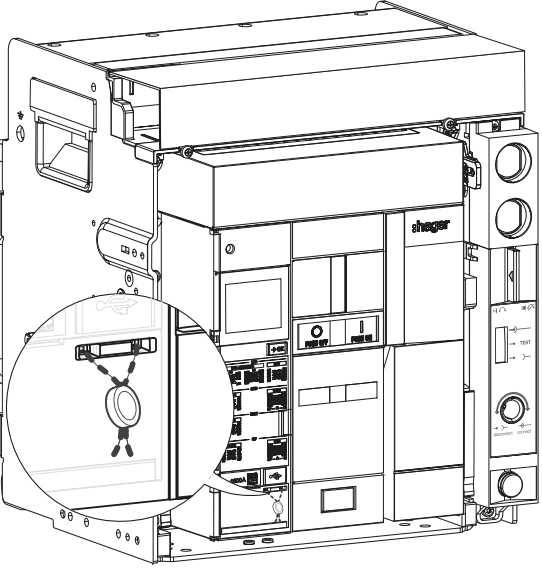
	Action	Illustration
13	Apply a seal to the cover if necessary.	 A technical line drawing of a Hager electrical cabinet. The cabinet is shown from a three-quarter perspective, with its front door open. The door is hinged on the right side. A circular callout on the left side of the door shows a close-up of a seal being applied to the inner edge of the door. The seal is a circular ring with a central hole. The callout also shows a small figure of a person applying the seal. The main drawing shows the interior of the cabinet with various electrical components, including a terminal block, a fuse holder, and a circuit breaker. The Hager logo is visible on the right side of the door.

Using a computer equipped with the **Hager Power setup** testing and commissioning software, it is possible to enter protection settings according to the values recorded in the Hagercad project.

The computer must be connected to the USB-C port of the electronic trip unit.

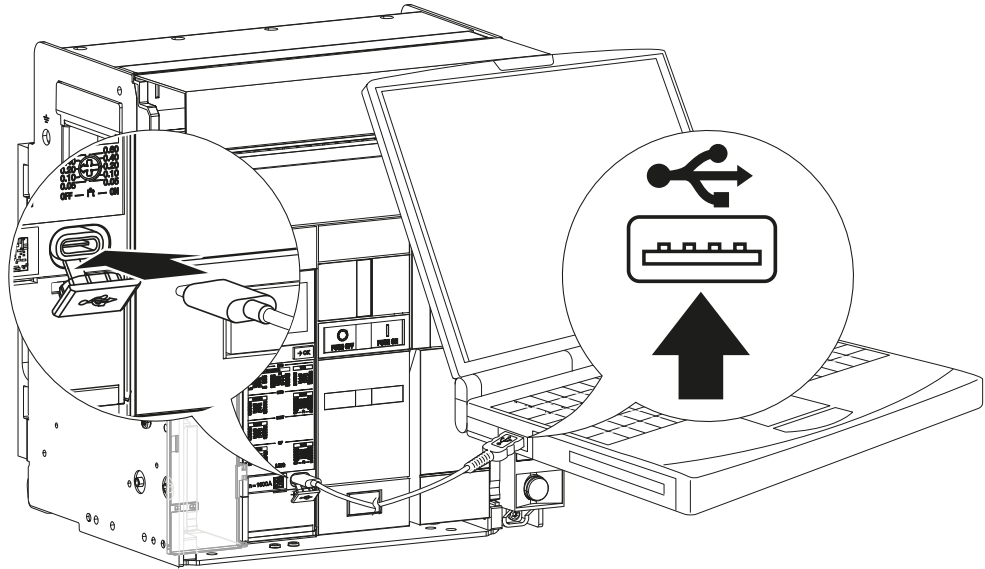

In our example, the circuit breaker rating is 1600 A.

**Example of Ir current setting**

$$I_r = I_{r1} \times I_{r2} \times I_n = 0.5 \times 0.92 \times 1600 = 736 \text{ A}$$

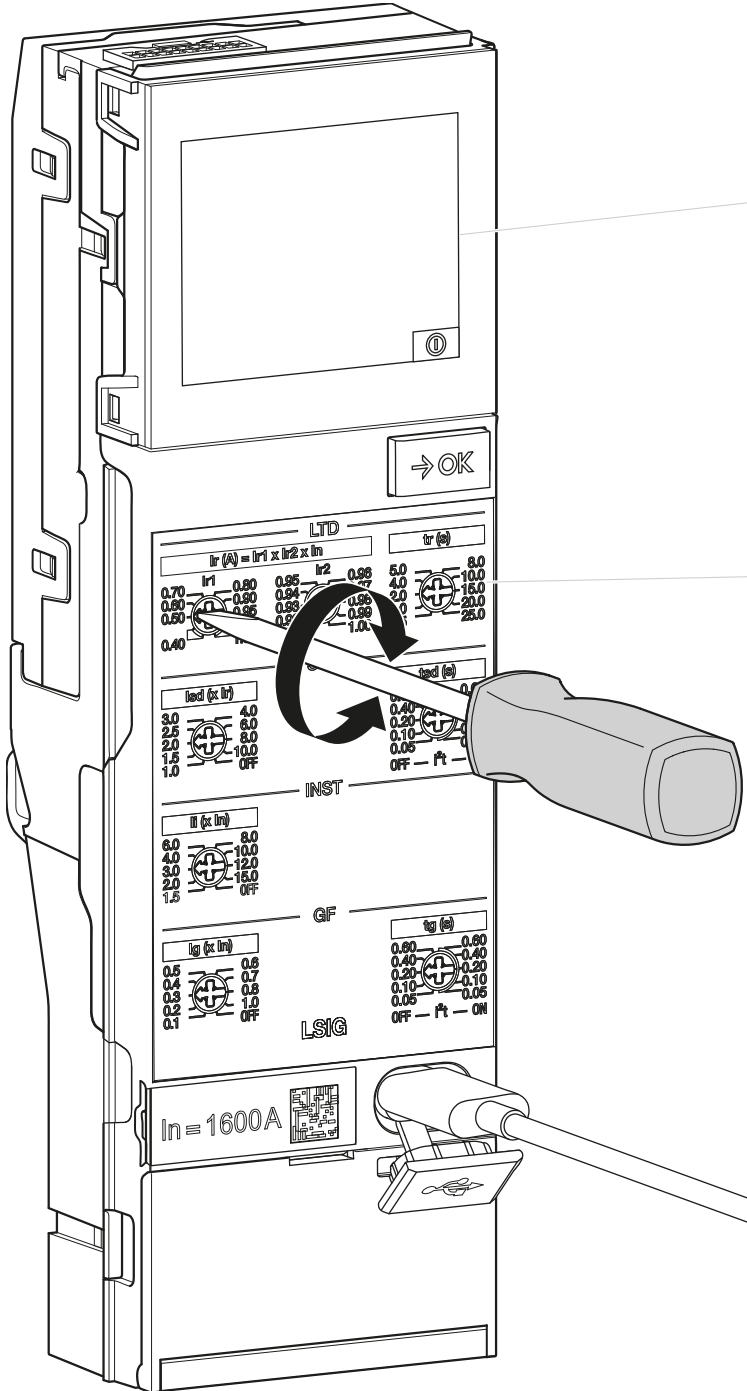

LTD									
Ir (A) = Ir1 x Ir2 x In						tr (s)			
Ir1		Ir2							
0.70	0.80	0.95	0.96	5.0	8.0				
0.60	0.80	0.94	0.97	4.0	10.0				
0.50	0.95	0.93	0.98	2.0	15.0				
0.40	1.00	0.92	0.99	1.0	20.0				
		0.91	1.00	0.5	25.0				

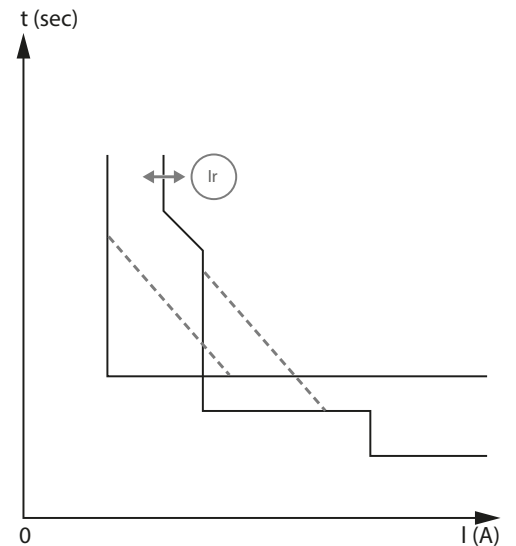

Characteristic of the affected curve

**⚠ WARNING**

**Risk of settings that are non-compliant with the short circuit and selectivity calculations.**  
 This example is given on an illustrative basis only to show the behaviour of the display when the dials are used.  
 In order to correctly adjust the trip unit, a short circuit and selectivity calculation must be performed for the installation in advance by the electrical designer. This will allow the circuit breaker to protect the installation in complete safety.



Example of setting of the tripping  $t_r$  time delay

$t_r = 2$  s

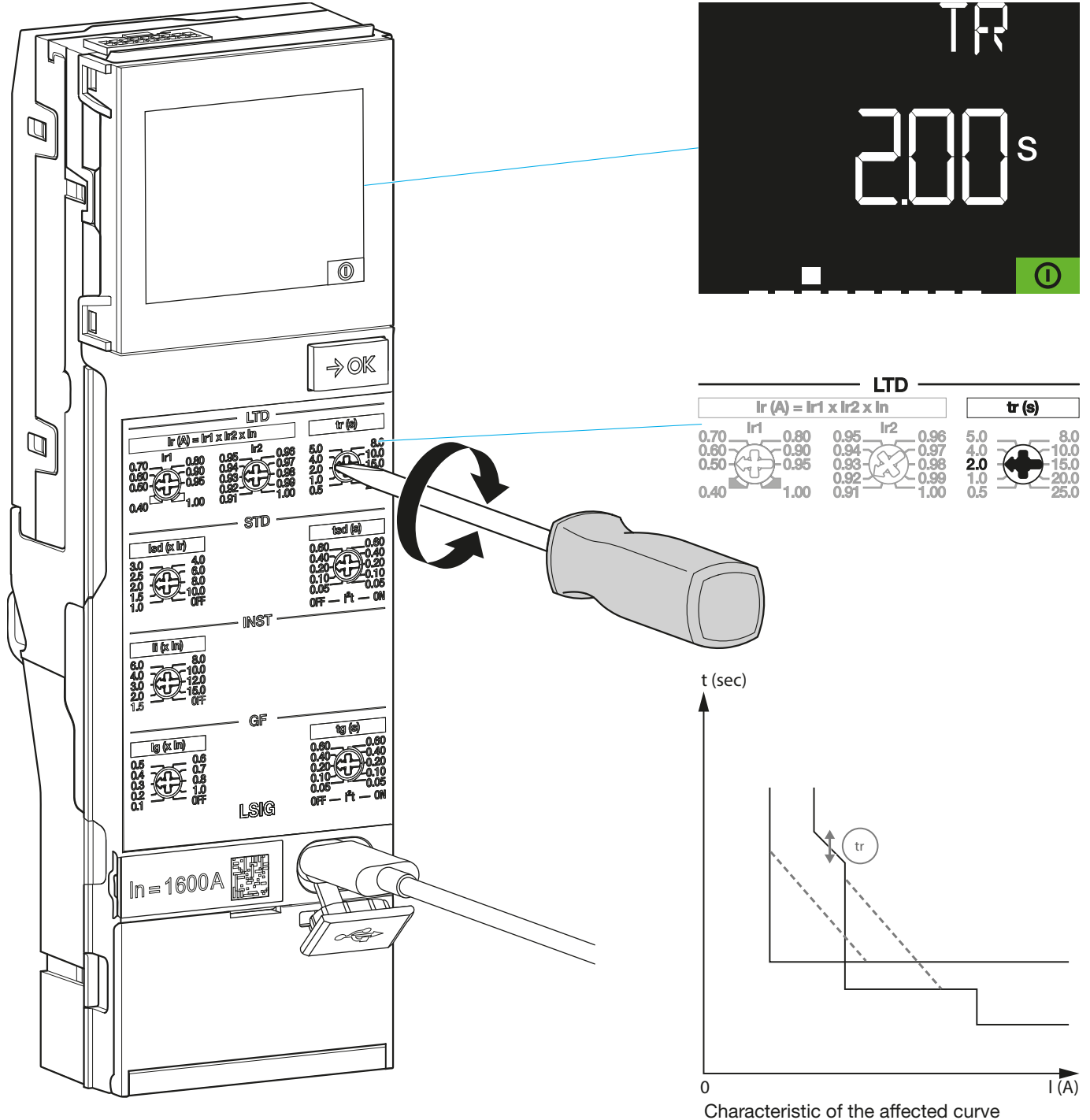

**WARNING**

**Risk of settings that are non-compliant with the short circuit and selectivity calculations.**

This example is given on an illustrative basis only to show the behaviour of the display when the dials are used.

In order to correctly adjust the trip unit, a short circuit and selectivity calculation must be performed for the installation in advance by the electrical designer. This will allow the circuit breaker to protect the installation in complete safety.

In our example, the circuit breaker rating is 1600 A and  $I_r = 736$  A.

**Example of Isd current setting**

$$I_{sd} = 8 \times I_r = 8 \times 736 = 5888 \text{ A}$$

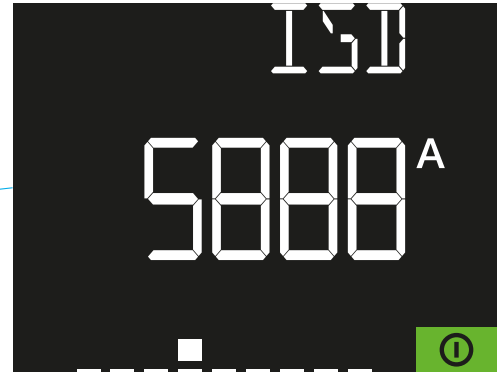
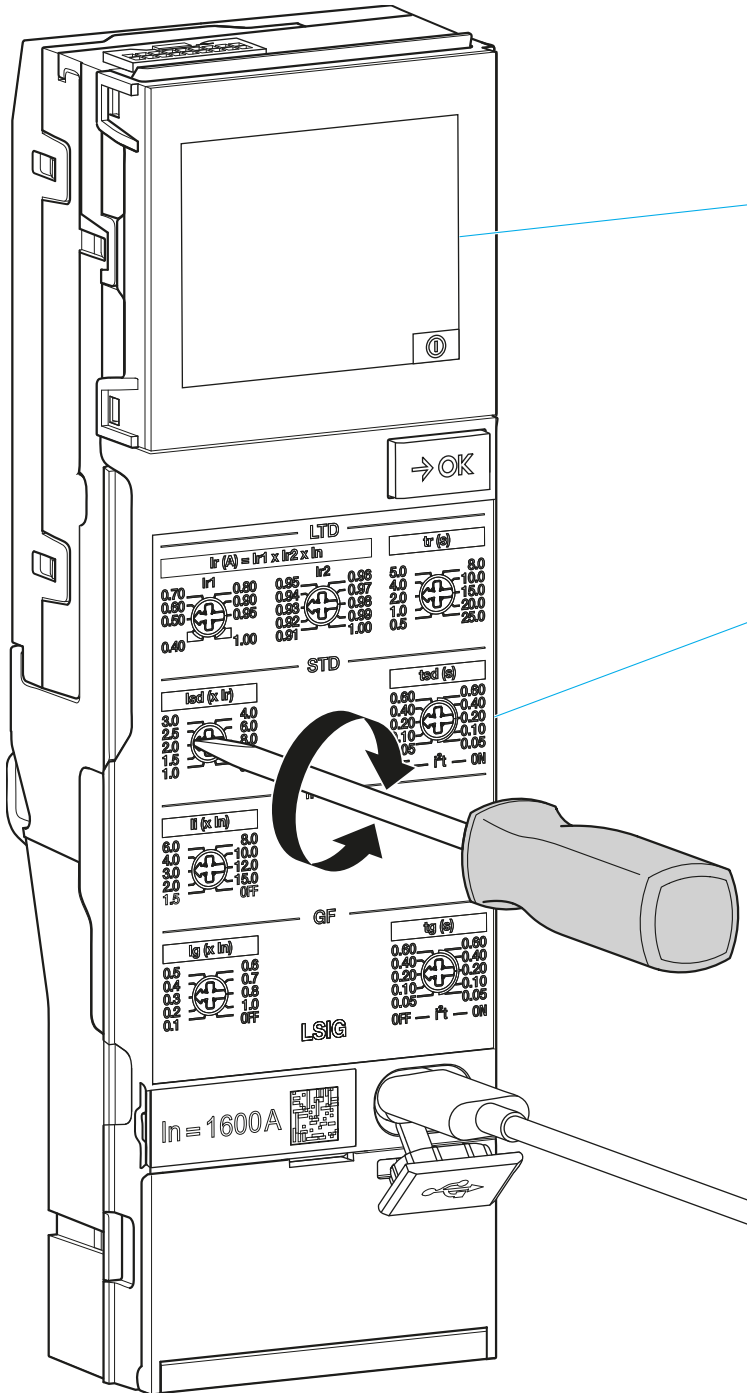

Isd (x Ir)		tsd (s)	
3.0	4.0	0.60	0.60
2.5	6.0	0.40	0.40
2.0	8.0	0.20	0.20
1.5	10.0	0.10	0.10
1.0	OFF	0.05	0.05
		OFF	i <sup>2</sup> t ON

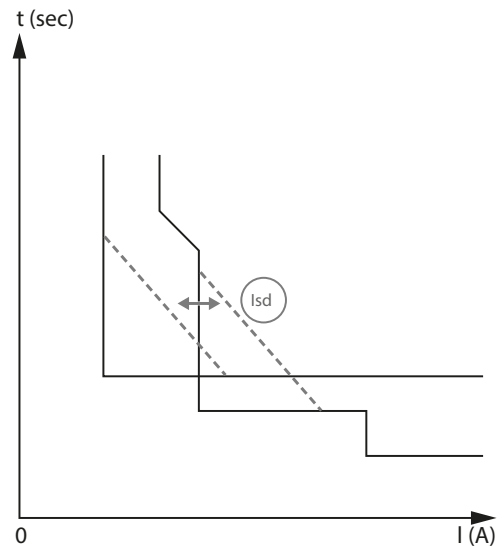

Characteristic of the affected curve

**⚠ WARNING**

**Risk of settings that are non-compliant with the short circuit and selectivity calculations.**  
 This example is given on an illustrative basis only to show the behaviour of the display when the dials are used.  
 In order to correctly adjust the trip unit, a short circuit and selectivity calculation must be performed for the installation in advance by the electrical designer. This will allow the circuit breaker to protect the installation in complete safety.



In our example, the circuit breaker rating is 1600 A.

**Example of Ii current setting**

$$I_i = 15 \times I_n = 15 \times 1600 = 24000 \text{ A}$$

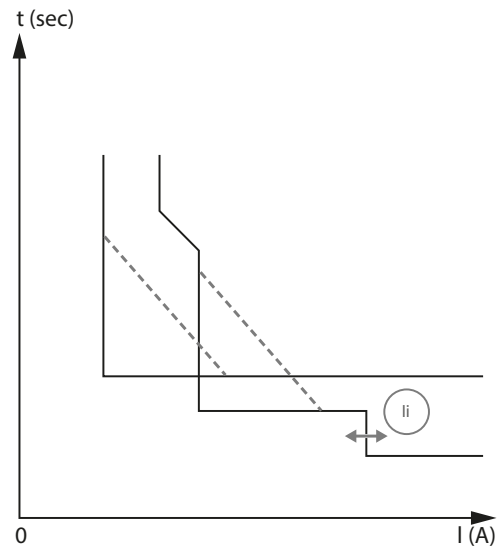
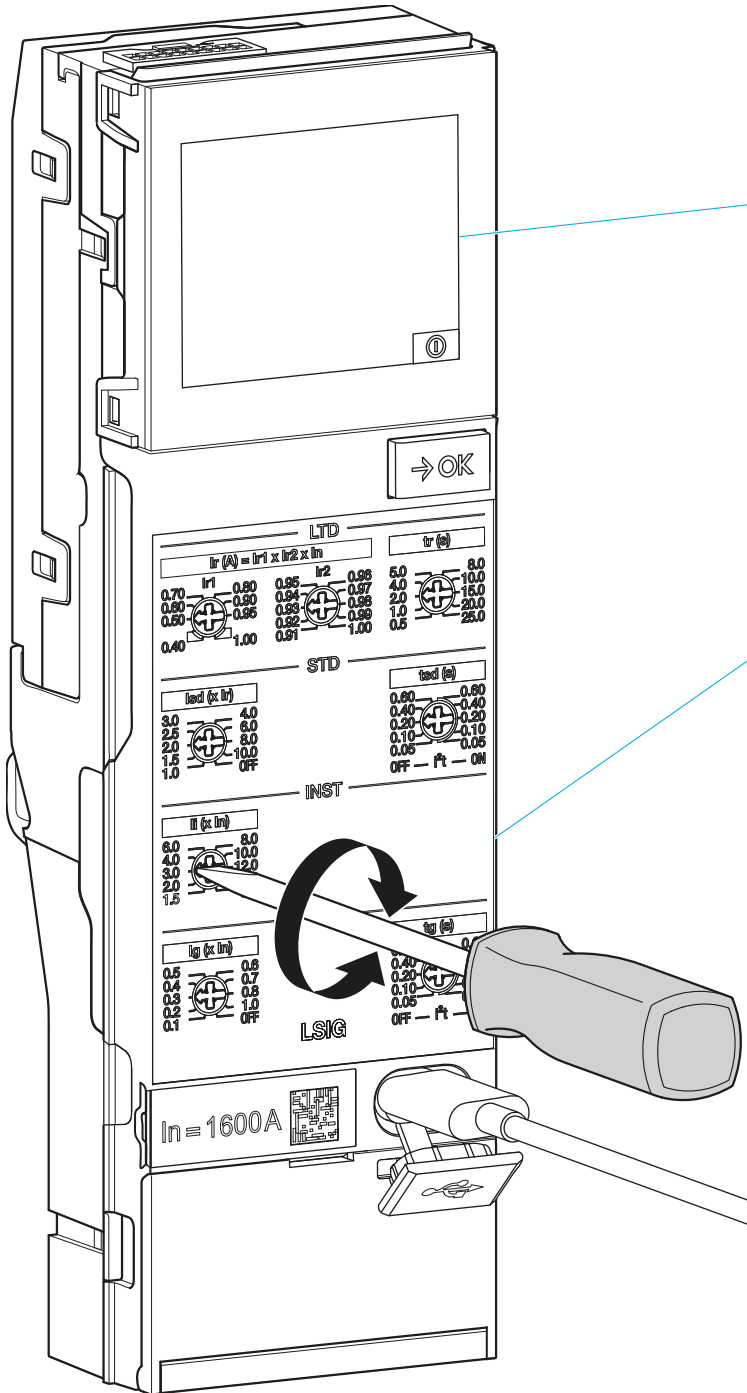

Characteristic of the affected curve

**⚠ WARNING**

**Risk of settings that are non-compliant with the short circuit and selectivity calculations.**

This example is given on an illustrative basis only to show the behaviour of the display when the dials are used.

In order to correctly adjust the trip unit, a short circuit and selectivity calculation must be performed for the installation in advance by the electrical designer. This will allow the circuit breaker to protect the installation in complete safety.

In our example, the circuit breaker rating is 1600 A.

**Example of I<sub>g</sub> current setting**

$$I_g = 0.4 \times I_n = 0.4 \times 1600 = 640 \text{ A}$$

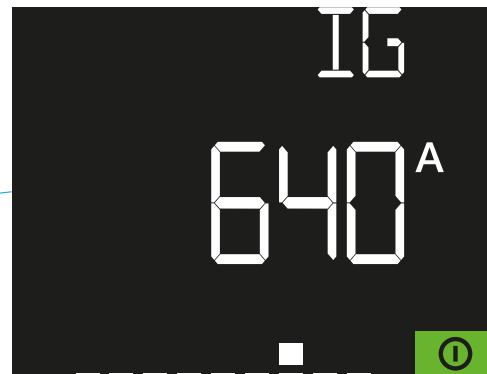
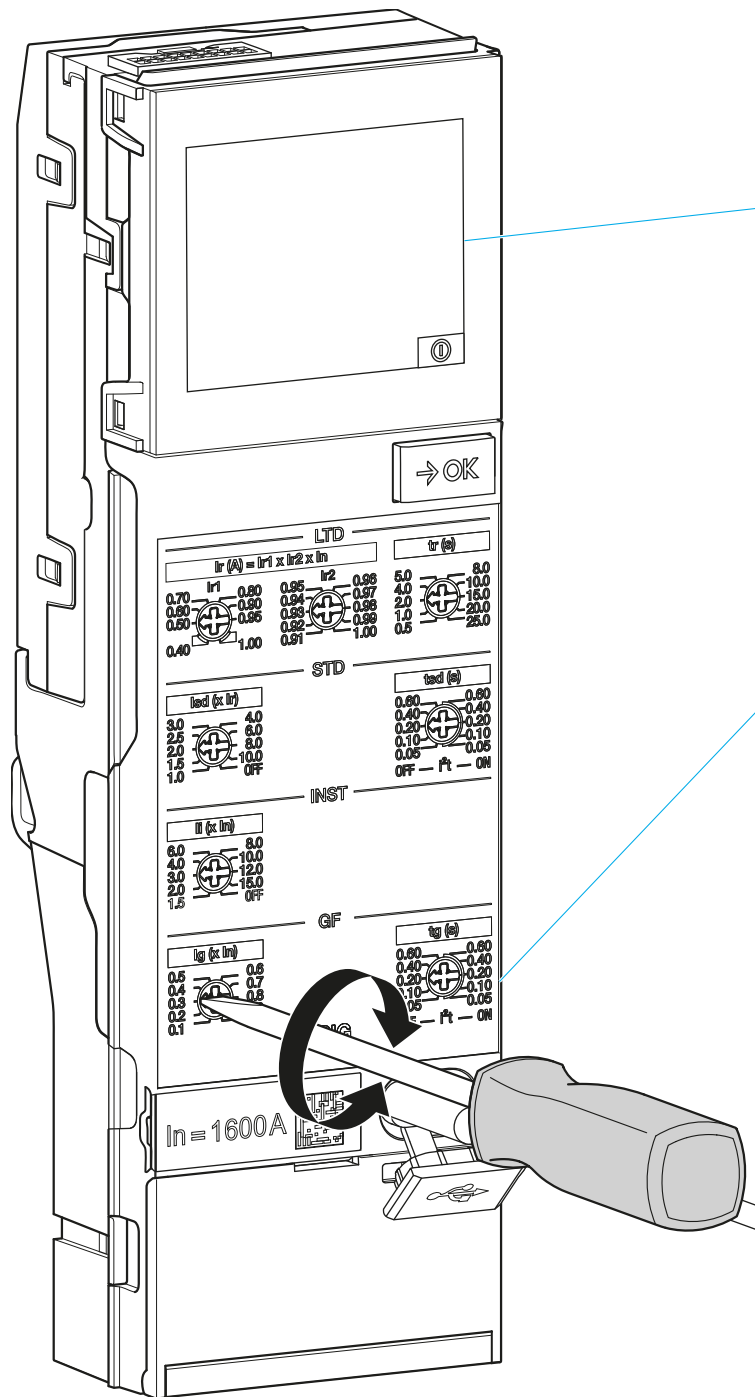

I <sub>g</sub> (x I <sub>n</sub> )		t <sub>g</sub> (s)	
0.5	0.6	0.60	0.60
0.4	0.7	0.40	0.40
0.3	0.8	0.20	0.20
0.2	1.0	0.10	0.10
0.1	OFF	0.05	0.05
		OFF	i <sup>2</sup> t — ON

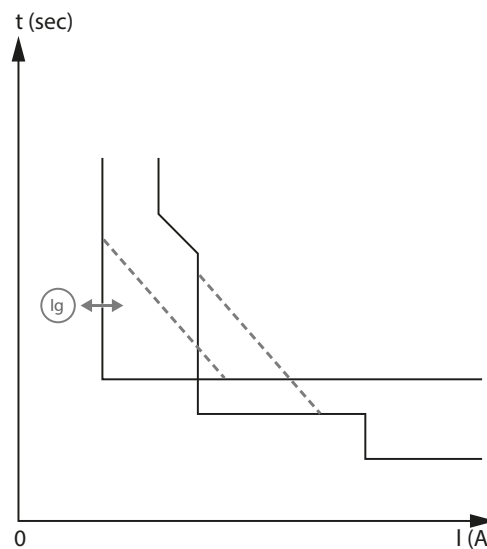

Characteristic of the affected curve

**⚠ WARNING**

**Risk of settings that are non-compliant with the short circuit and selectivity calculations.**

This example is given on an illustrative basis only to show the behaviour of the display when the dials are used.

In order to correctly adjust the trip unit, a short circuit and selectivity calculation must be performed for the installation in advance by the electrical designer. This will allow the circuit breaker to protect the installation in complete safety.

Example of tg tripping time delay setting

tg = 0.6 s with I<sup>2</sup>t set to OFF

The diagram illustrates the configuration of the earth fault (GF) protection settings on a circuit breaker. A hand is shown adjusting the 'tg (s)' dial to 0.60. The digital display shows 'TG 0.60 S'. The settings menu includes:

- LTD**:  $I_r (A) = I_{r1} \times I_{r2} \times I_n$  with various settings for  $I_{r1}$ ,  $I_{r2}$ , and  $I_n$ .
- STD**:  $I_{sd} (x I_n)$  and  $t_{sd} (s)$  settings.
- INST**:  $I (x I_n)$  settings.
- GF**:  $I_g (x I_n)$  and  $t_g (s)$  settings. The  $t_g$  dial is set to 0.60.
- LSIG**:  $I_g (x I_n)$  settings.

The graph shows the characteristic of the affected curve, plotting time  $t$  (sec) against current  $I$  (A). The curve shows a time delay  $t_g$  before the tripping time begins to decrease as current increases.

**⚠ WARNING**

**Risk of settings that are non-compliant with the short circuit and selectivity calculations.**

This example is given on an illustrative basis only to show the behaviour of the display when the dials are used.

In order to correctly adjust the trip unit, a short circuit and selectivity calculation must be performed for the installation in advance by the electrical designer. This will allow the circuit breaker to protect the installation in complete safety.

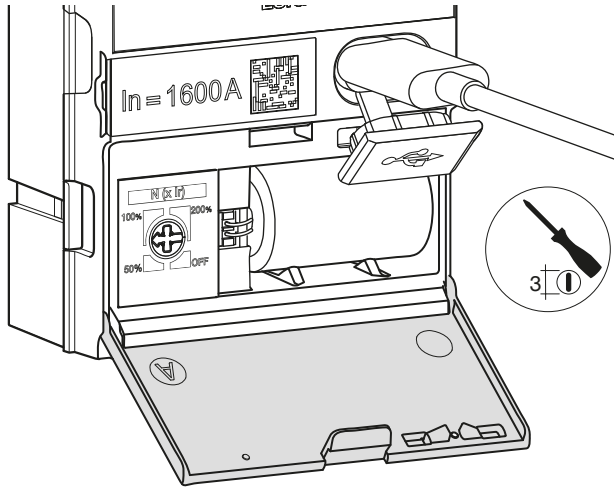
	Action	Illustration
1	Open the backup battery housing cover before connecting the USB-C socket (cf. Chapter 4.1 Principle).	
2	Adjust the desired setting then close the cover.	See the diagram on the next page.

**ATTENTION**

The battery housing cover cannot be opened or closed if an external battery is connected to the USB-C port

In our example, the circuit breaker rating is 1600 A.

### Example of neutral protection

$$N = 50\% \times I_r = 50\% \times 736 = 368 \text{ A}$$

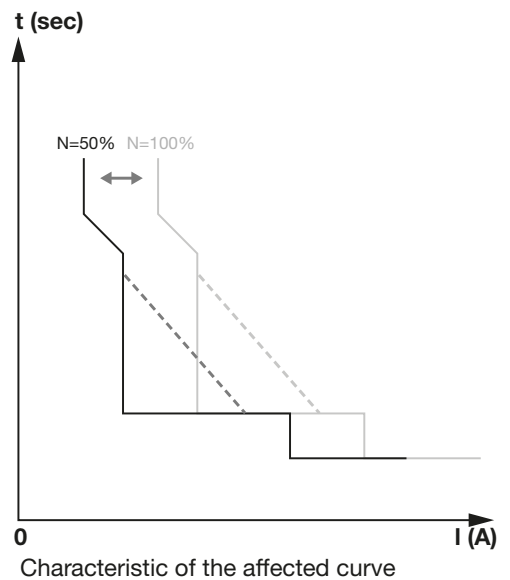
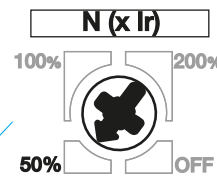
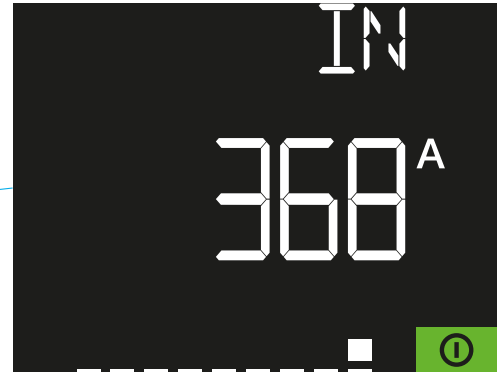
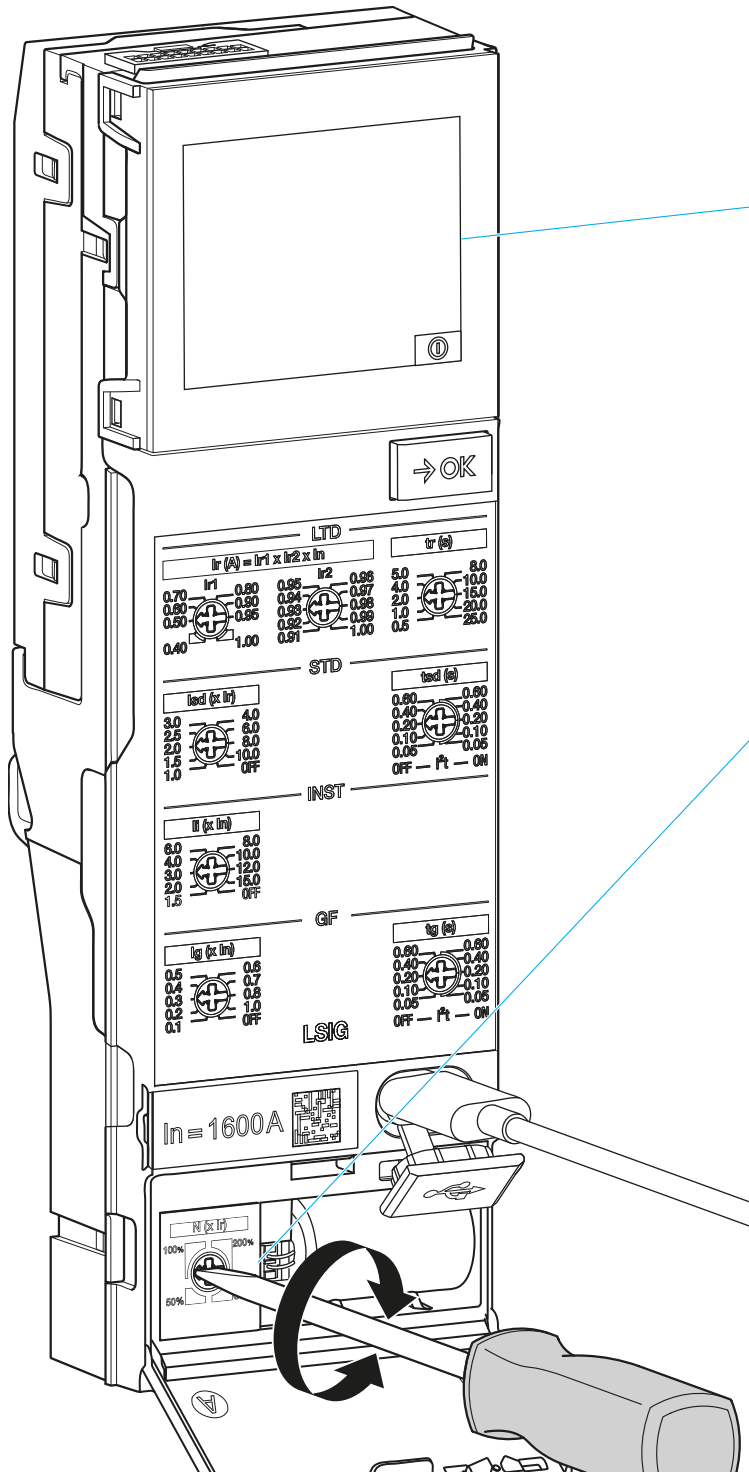

### WARNING

**Risk of settings that are non-compliant with the short circuit and selectivity calculations.**

This example is given on an illustrative basis only to show the behaviour of the display when the dials are used.

In order to correctly adjust the trip unit, a short circuit and selectivity calculation must be performed for the installation in advance by the electrical designer. This will allow the circuit breaker to protect the installation in complete safety.



To review the settings adjusted:

	Action	Illustration
1	Briefly press the button <b>→OK</b> .	
2	check that the following screen displays. It indicates the maximum instantaneous current as well as the phase concerned.	
3	Each short press switches between the following screens.	See the order of the screens on the next page.

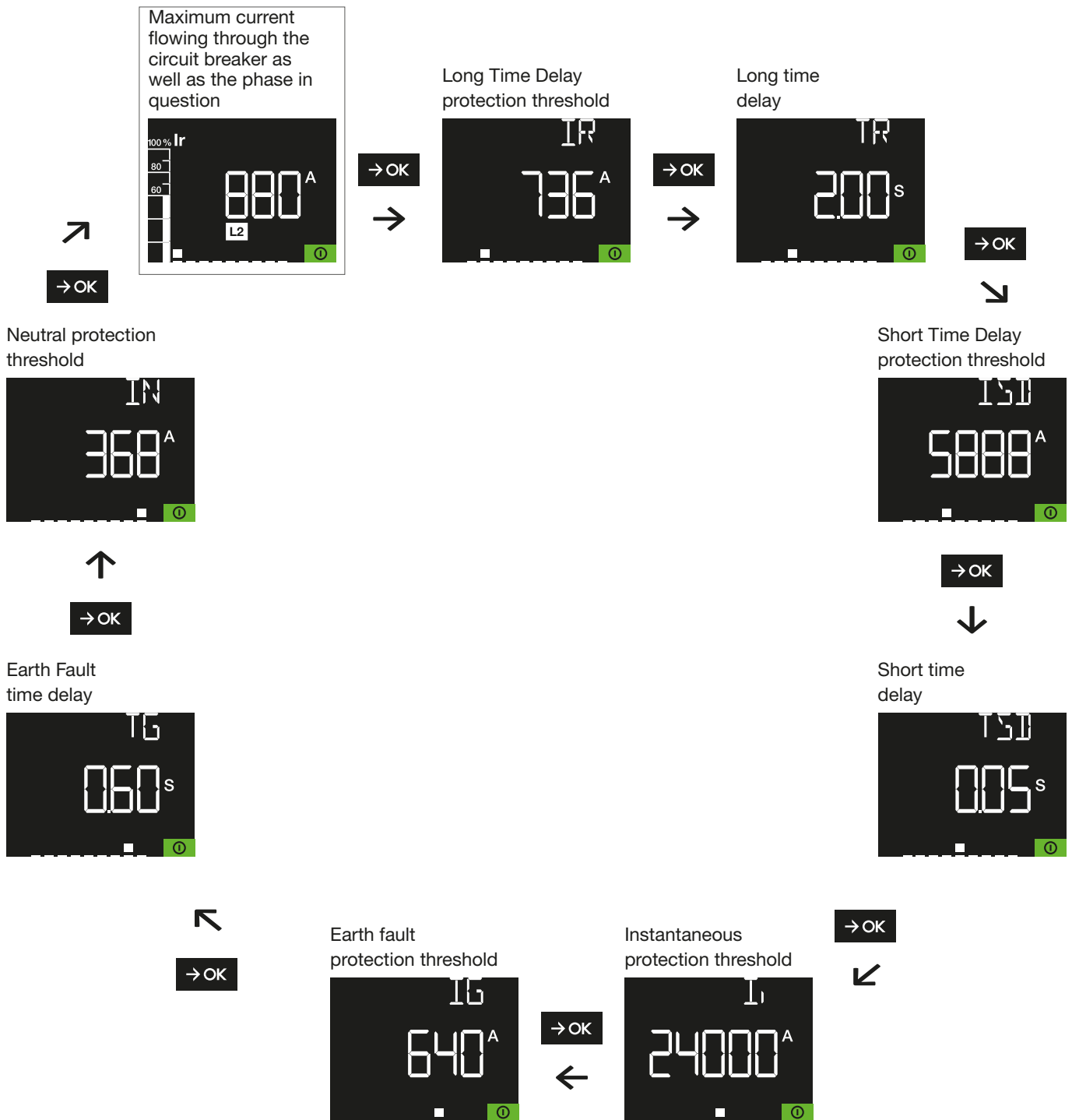



The order of the screens described corresponds to the LSIG electronic trip unit.

**ATTENTION**

In case of error, an additional screen appears first. The error indicator also appears on all the screens.

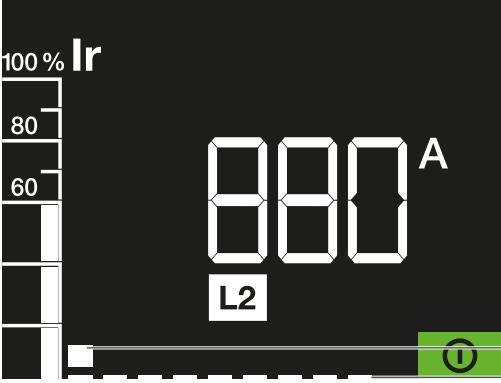
1. Error code (see Chapter 6.4 System alarm).
2. Error indicator

	Action	Illustration								
4	<p>To facilitate navigation, a screen identifier ① indicates the position in relation to the number of screens available ②.</p>	 <p>① Screen identifier</p> <p>②</p> <table border="1" data-bbox="879 775 1326 920"> <thead> <tr> <th>Trip unit</th> <th>Number of screens</th> </tr> </thead> <tbody> <tr> <td>LI</td> <td>5 - 6 in case of error</td> </tr> <tr> <td>LSI</td> <td>7 - 8 in case of error</td> </tr> <tr> <td>LSIG</td> <td>9 - 10 in case of error</td> </tr> </tbody> </table>	Trip unit	Number of screens	LI	5 - 6 in case of error	LSI	7 - 8 in case of error	LSIG	9 - 10 in case of error
Trip unit	Number of screens									
LI	5 - 6 in case of error									
LSI	7 - 8 in case of error									
LSIG	9 - 10 in case of error									
5	<p>check that if no action is performed for 30 seconds on the →OK button, the display returns to its standby screen.</p>									



**DANGER**

**Risk of electric shock, electrocution or electric arc.**

**Danger to life, risk of injury due to electric shock, or risk of serious injury.**

Ensure that the device is only commissioned by qualified personnel who are equipped with adequate safety equipment.

For commissioning, refer to the operations described in standard IEC 61439-1 and -2.

## ATTENTION

For any further information about commissioning the circuit breaker, contact Hager Technical Support.

## ATTENTION

The Hager Power setup tool is recommended in order to carry out the protection settings when commissioning the electronic trip unit or before.

The sentinel electronic trip unit is used to manage 4 types of alarms:

- Overload pre-alarm PTA
- Overload alarm
- Trip alarm
- System alarm

The PTA overload pre-alarm provides a warning when the situation is close to overload after a load current greater than 90% of  $I_r$  is reached. Preventive measures (load-shedding, maintenance, etc.) can then be taken before the circuit breaker trips, avoiding a power outage.

The overload pre-alarm PTA is defined by two parameters:

- The PTA threshold equivalent to 90%  $I_r$
- The PTA time delay equivalent to 50%  $t_r$

It activates for any current (gradual rise or current peak) reaching the **surveillance zone**.

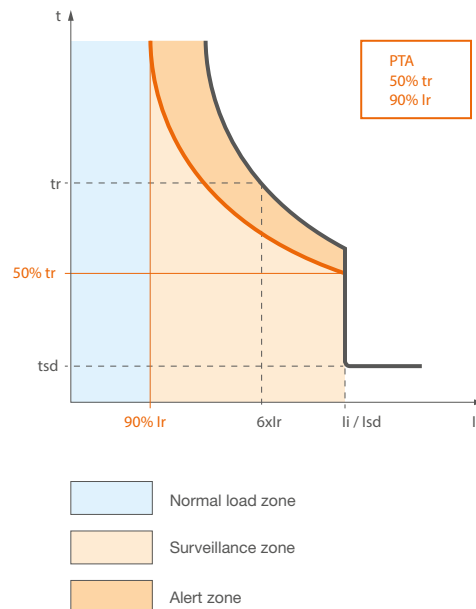

This **alert zone** is bounded on one hand by the threshold and time delay of the PTA overload pre-alarm and on the other hand by the  $I_r$  pick-up and  $t_r$  time delay. The **surveillance zone** starts from the PTA threshold.

The PTA overload pre-alarm is signalled by a screen of this type:

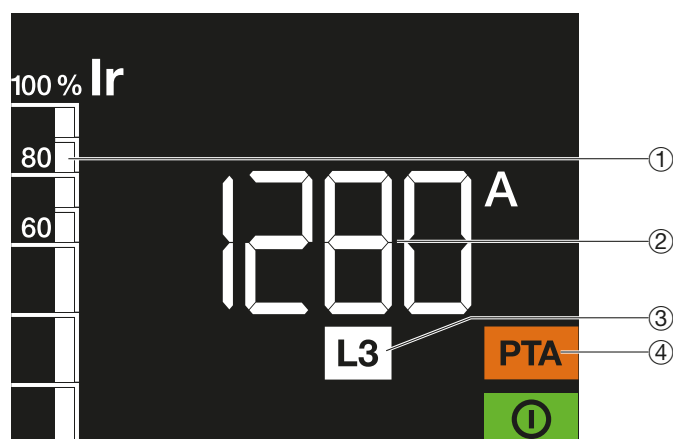

- ① Percentage of the  $I_r$  current reached
- ② Value in amps of the current flowing through the circuit breaker on the most highly loaded phase
- ③ Relevant phase
- ④ Overload pre-alarm indicator:

Normal load zone	Surveillance zone	Alert zone
off	flashing	fixed

Thanks to the OAC output alarm contact module available as an accessory and inserted at the rear of the electronic trip unit, the overload pre-alarm is linked to the PTA output contact on the circuit breaker terminal block (see Installation manual 6LE007893A).

The overload alarm is activated as soon as the current  $\geq 105\%$  of the  $I_r$  value.

In the event of an overload alarm, a screen of this type is displayed with the indicators ③ and ① flashing.

Above  $112.5\%$  of  $I_r$ , the indicator ③ is steady.

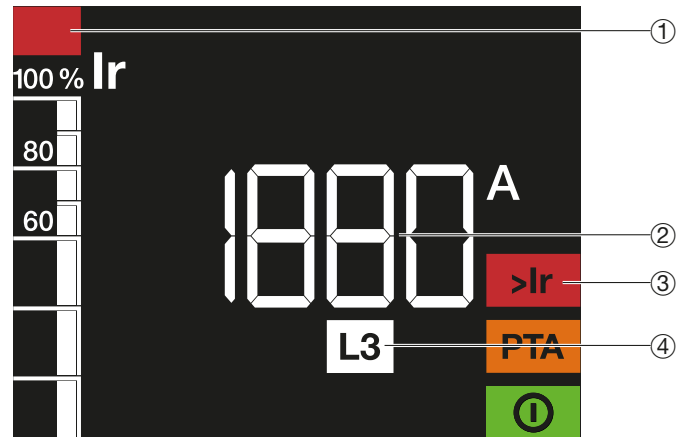

- ① Overload indicator
- ② Maximum current value reached
- ③ Overload alarm indicator
- ④ Phase in which the maximum current has been reached

If the circuit breaker trips (overload, short circuit, earth fault, trip unit fault), the circuit breaker opens. The electronic trip unit display is then powered by its backup battery. A screen of this type flashes for a maximum of 6 hours or until the fault is acknowledged. The use of a 24 V DC SELV external power supply can extend the display beyond 6 hours.

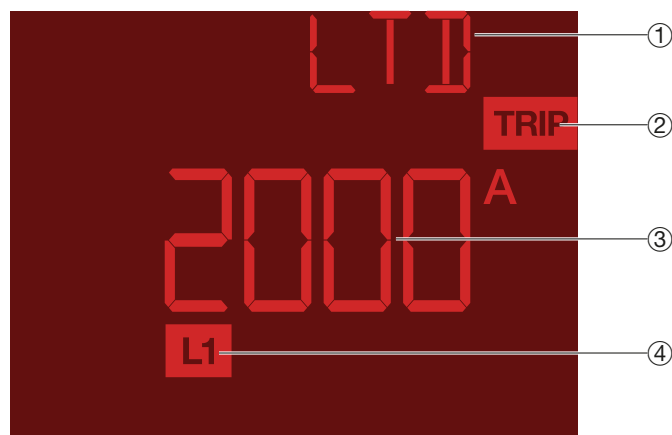

- | ① Display  | Tripping type               |
|------------|-----------------------------|
| LTD        | Long time delay protection  |
| STD        | Short time delay protection |
| INST / MCR | Instantaneous protection    |
| GF         | Earth fault protection      |
- ② Trip indicator
  - ③ Fault current value (only for tripping causes long delay, short delay, Instantaneous and earth protection), or error code at the origin of the tripping for a malfunction of the electronic trip unit.
  - ④ Phase concerned by the fault (only for Long time delay, Short time delay and Instantaneous tripping causes)

Thanks to the OAC output alarm contact module available as an accessory and fitted at the rear of the electronic trip unit, the trip alarms are transferred to the LTD, STD/INST, GF output contacts located on the circuit breaker terminal block (see Installation manual 6LE007893A).



The system alarms signal malfunctions of the trip unit's electronic system. They can be of two types:

- critical: this is a serious malfunction. The trip unit is no longer capable of performing its protection function
- non-critical: the incident has no effect on the protection function.

Non-critical system alarms are indicated by a flashing screen of this type:



- ① Error indicator
- ② Error code
- ③ ReadyToProtect indicator: the trip unit remains operational.

For the meanings of the different non-critical system alarms, refer to the table below:

Error code	Meaning	Recommended action	
E019	Internal error No. 1	For more information, see the maintenance guide.	
E020	Faulty dial		
E021	High temperature of the electronic trip unit	Check that the temperature inside the distribution board is not too high.	
E022	Trip unit key or button faulty	For more information, see the maintenance guide.	
E023	Digital Input faulty		
E025	Internal error No. 2		
E027	Internal error No. 3		
E028	Internal error No. 4		
E029	Internal error No. 5		
E035	Internal error No. 7		
E036	Internal error No. 8		
E040	Zone Selectivity Input (ZSI) activated		Appears when the trip unit receives the ZSI signal from the downstream circuit breaker.
E042	Internal error No. 9		For more information, see the maintenance guide.
E043	Short Time Delay and Instantaneous Protections deactivated	The Short time delay and Instantaneous protections cannot be deactivated simultaneously. Reactivate one of them.	
E100 to E200	Manufacturing fault	Contact your Hager representative or local Hager technical support (contact details on the Hager website for your country).	

The critical system alarms can be set to trip the circuit breaker or to report the error code only.

In the factory default settings, the critical system alarms with codes E001 to E012 are configured for tripping and are signalled by a flashing screen of this type:



① Trip indicator

② Error code

For the meanings of the different critical system alarms, refer to the table below:



Error code	Meaning	Recommended action
E001	L1 current sensor out of service	Contact your Hager representative or local Hager technical support (contact details on the Hager website for your country).
E002	L2 current sensor out of service	
E003	L3 current sensor out of service	
E004	N current sensor out of service	
E005	MHT actuator out of service	
E006	Critical error No.4	
E007	Critical error No.3	
E008	Critical error No.2	
E009	Rating plug out of service	Replace the rating plug.
E010	Critical error No. 5	Contact your Hager representative or local Hager technical support (contact details on the Hager website for your country).
E011	Critical error No.1	
E012	Overheating of the electronic trip unit	Check that the temperature inside the distribution board is not too high.

**Note:** the sentinel trip units have a temperature sensor that can protect them from malfunction following overheating of the sensitive internal components. The E021 non-critical system alarm issues an initial alert level when the internal temperature reaches 75°C. Reaching a temperature of 85°C will cause the display to switch off but the trip unit will remain operational until the temperature reaches 90°C which will activate the E012 critical system alarm and will cause the circuit breaker to trip.

ATTENTION
For further information about the meaning of the system alarms, please refer to the Maintenance guide 6LE007897A.

The critical system alarms configured for a tripping operation can also be signalled on the HWF output contact of the OAC optional alarm output contacts module.

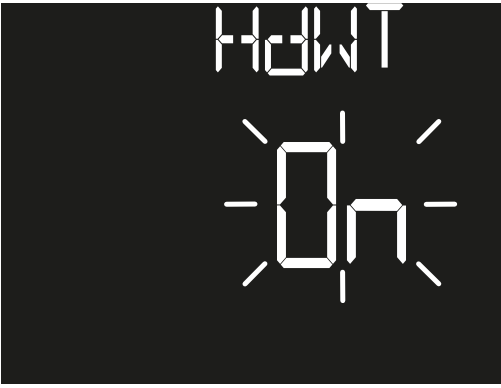
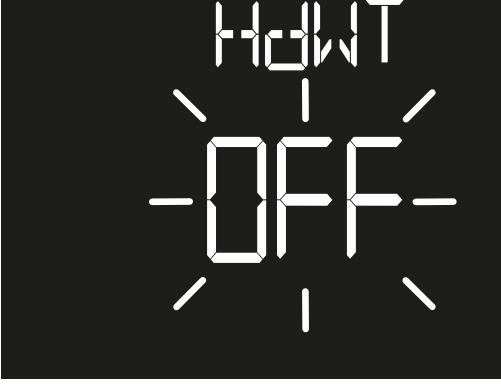
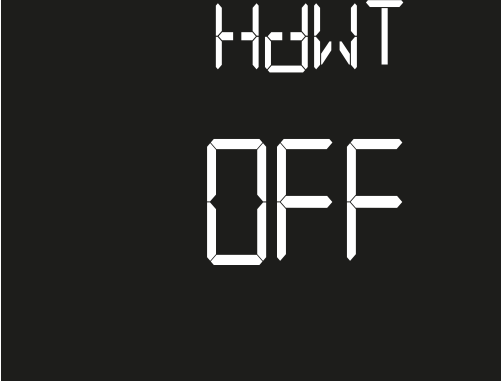
The critical system alarms are configurable via the unique HdWT parameter.  
To change this parameter:

	Action	Illustration
1	<p>Press the <b>→OK</b> key for longer than 10 s until this screen appears with an "ON" (if the current setting is at "ON").</p>	
2	<p>Briefly press the <b>→OK</b> key to switch the display to "ON" or "OFF" according to the setting desired.</p>	 <p>"On" display: the critical system alarms cause the circuit breaker to trip. "OFF" display: the critical system alarms do not cause the circuit breaker to trip and are only signalled by their error code.</p>
3	<p>To confirm your choice, press the <b>→OK</b> button for longer than 3 s. The "On" or "OFF" display becomes steady.</p>	
4	<p>Check that after 3 s without pressing the <b>→OK</b> button, the display reverts to its standby screen.</p>	

When the maintenance indicator is displayed, maintenance operations are required on the circuit breaker.

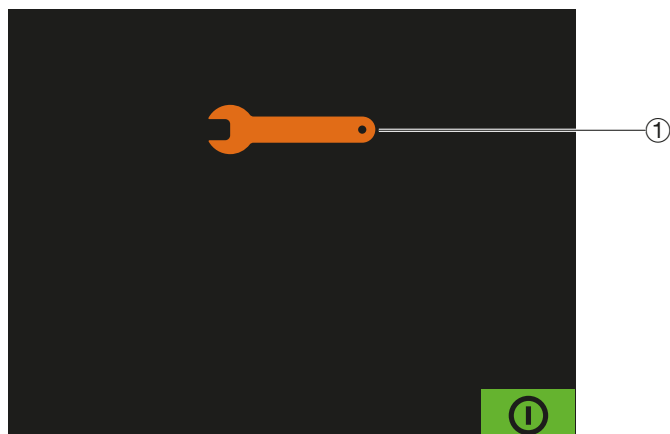

① Maintenance indicator

### ATTENTION

If the maintenance indicator appears, contact your maintenance manager, Hager Technical Support or refer to the 6LE007897A maintenance guide.

When the low or missing battery indicator appears, the electronic trip unit backup battery must be replaced.

The backup battery can be replaced with the circuit breaker open or closed.

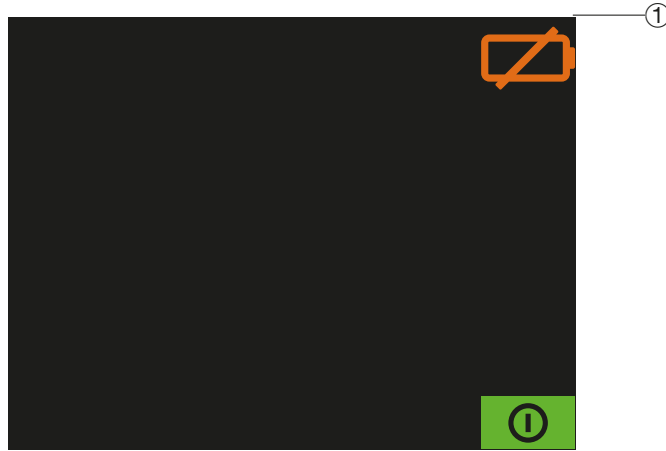

① Low or missing battery indicator





<b>ATTENTION</b>	
<p>If the backup battery is discharged, the electronic trip unit will be unable to display the cause of any tripping unless an external 24VDC SELV power supply is connected or an external battery is connected on the USB-C port of the electronic trip unit.</p>	

To do so:

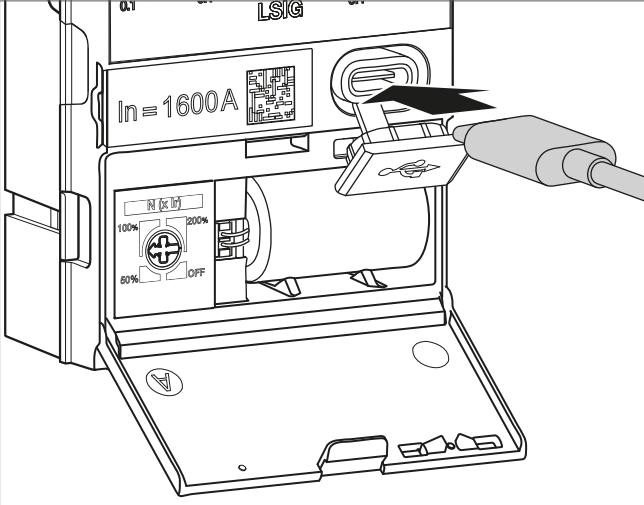
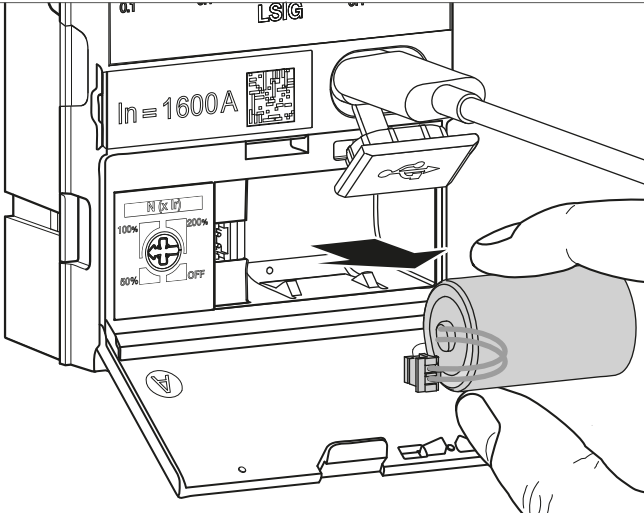
	Action	Illustration
1	<p>If required, remove the seal to open the trip unit transparent cover</p>	

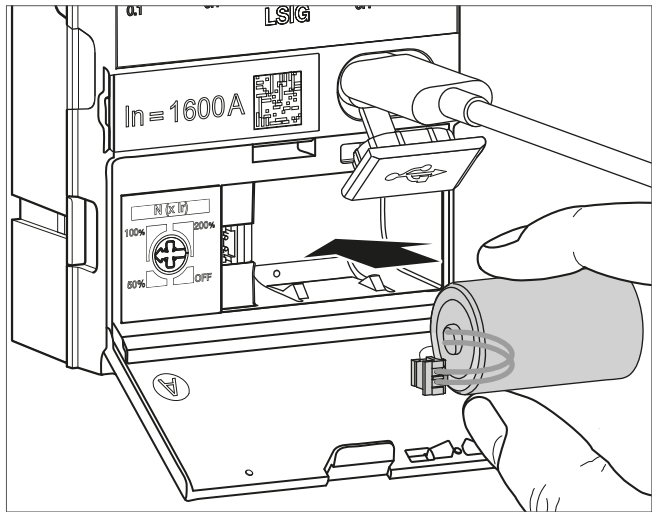
	Action	Illustration
2	Insert a screwdriver into the notch.	
3	Then open the cover.	
4	Remove the USB-C port cover.	

	Action	Illustration
5	Then connect an external battery to the USB-C port to continue powering the electronic trip unit's internal clock.	
6	Remove the old battery.	

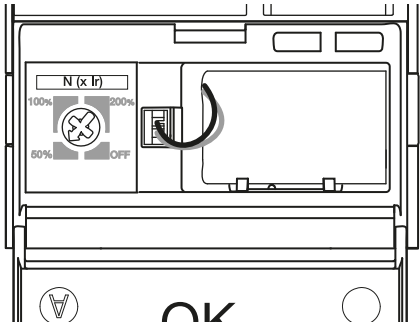
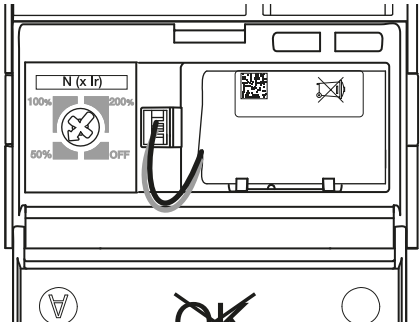
Action	Illustration
<p>7 Replace it with a new battery.</p>	
<p> <b>CAUTION</b></p>	
<p><b>Improper handling may result in a fire or chemical reaction.</b></p> <ul style="list-style-type: none"> <li> - Do not handle the battery without protection if you detect leaking electrolyte or if heat is given off.</li> <li> - Place the old battery only in a place intended for recycling.</li> </ul> <p>- To guarantee reliability, personal safety and material security, use only the Hager battery HWW463H, which is available as an accessory.</p>	
<p><b>ATTENTION</b></p>	
<p><b>Risk of property damage</b> Position the back-up battery and its wiring correctly inside the housing, then close the hatch.</p>	
<div style="display: flex; justify-content: space-around; align-items: center;"> <div style="text-align: center;">  <p><b>OK</b></p> </div> <div style="text-align: center;">  <p><del>OK</del></p> </div> </div>	

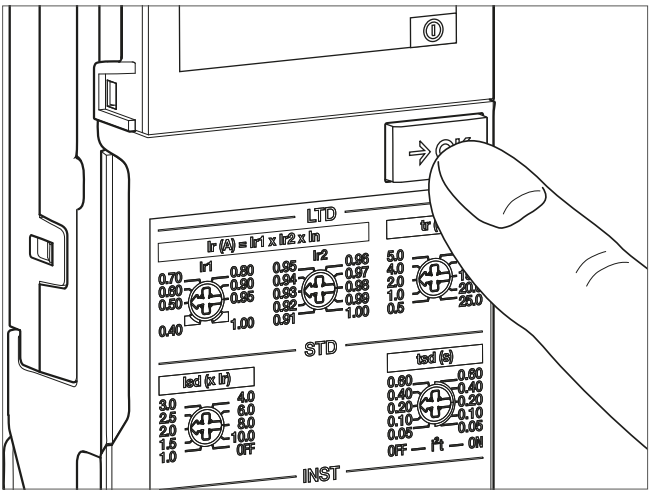
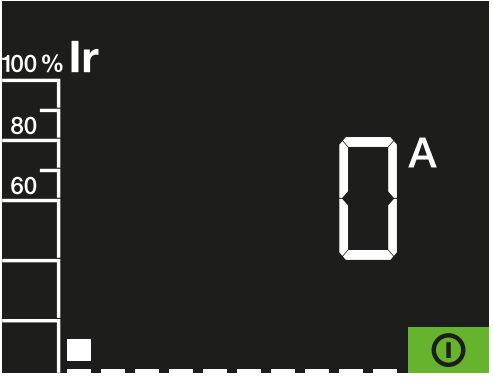
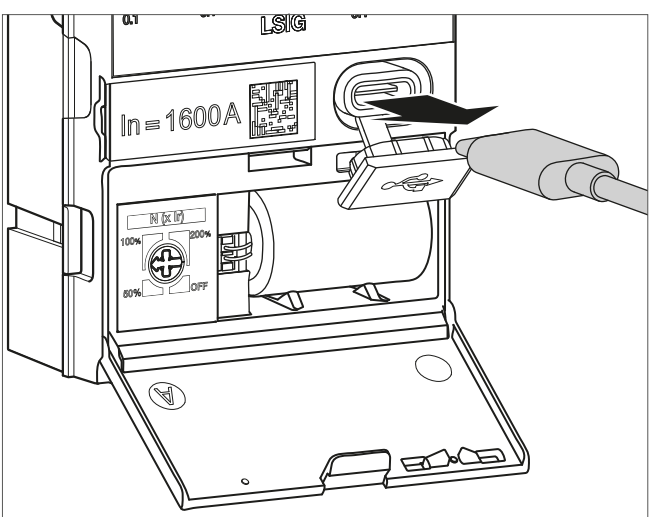

	Action	Illustration
8	<p>Check that there is no alarm on the display.</p> <p>Briefly press the <b>→OK</b> button to acknowledge the battery low or absent indicator.</p>	
9	<p>Check that the battery low or absent indicator disappears after 5 seconds.</p>	
<b>ATTENTION</b>		
<p>If an error indicator appears, refer to Chapter 03 hw+ circuit breaker troubleshooting in the 6LE007897Ab maintenance guide.</p>		
10	<p>Remove the external battery.</p>	

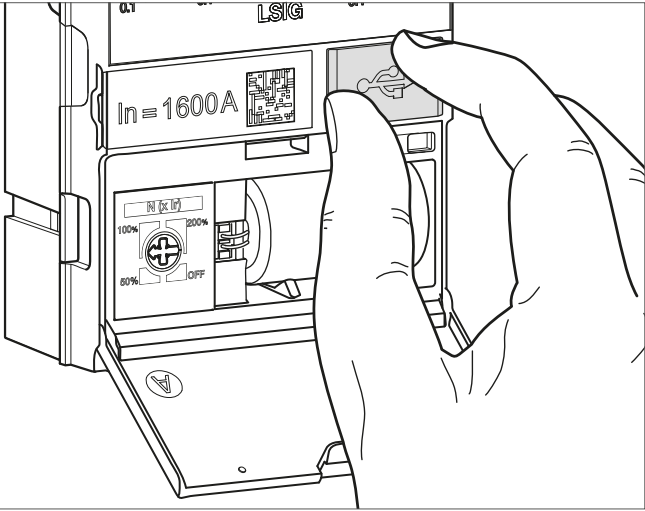
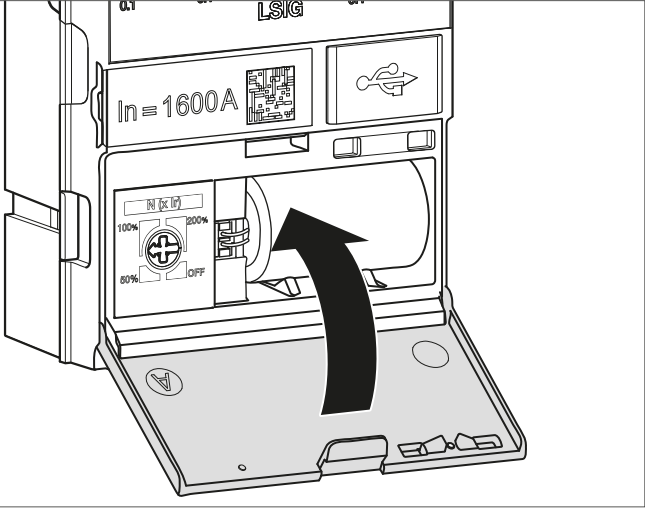
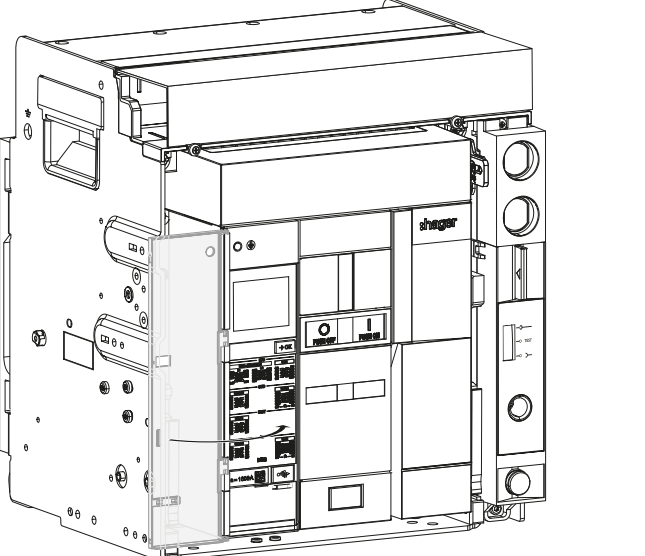
	Action	Illustration
11	Close the USB-C port cover.	
12	Close the cover.	
13	Close the transparent cover.	

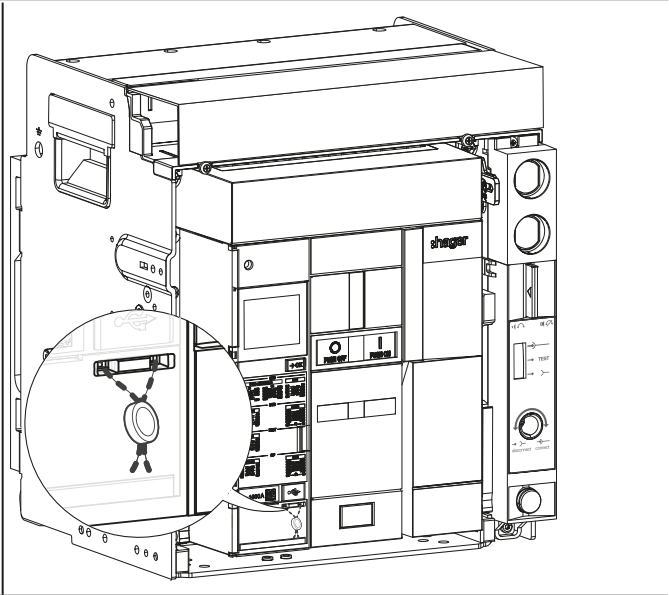
	Action	Illustration
14	Apply a seal to the cover if necessary.	 A technical line drawing of an open Hager electrical cabinet. The cabinet is shown from a three-quarter perspective, revealing its internal structure, including a main compartment with a door and a smaller compartment below it. The Hager logo is visible on the main compartment door. A circular callout on the left side of the main compartment shows a close-up of a seal being applied to the door's edge. The drawing includes various technical details such as screws, hinges, and internal components.

The value of the nominal current  $I_n$  can be changed by replacing the rating plug located on the front face of the electronic trip unit.

Reference of circuit breaker	Maximum rated current	Possible values	Reference of rating plug
HW1xx04...	400 A	400 A	HWW464H
HW1xx06...	630 A	400A	HWW464H
		630 A	HWW465H
HW1xx08...	800 A	400 A	HWW464H
		630 A	HWW465H
		800 A	HWW466H
HW1xx10...	1000 A	400 A	HWW464H
		630 A	HWW465H
		800 A	HWW466H
		1000 A	HWW467H
HW1xx12...	1250 A	400 A	HWW464H
		630 A	HWW465H
		800 A	HWW466H
		1000 A	HWW467H
		1250 A	HWW468H
HW1xx16...	1600 A	400 A	HWW464H
		630 A	HWW465H
		800 A	HWW466H
		1000 A	HWW467H
		1250 A	HWW468H
		1600 A	HWW469H

**CAUTION**

**Danger to life, risk of injury due to electric shock, or risk of serious injury.**  
 Before any intervention, ensure that the circuit breaker has been isolated from upstream and downstream power and control sources. Ensure that the MO charging motor is disconnected from its electrical supply.

To do so:

Action	Illustration
<p>1 If the circuit breaker is closed, and the spring is discharged or charged.</p>	

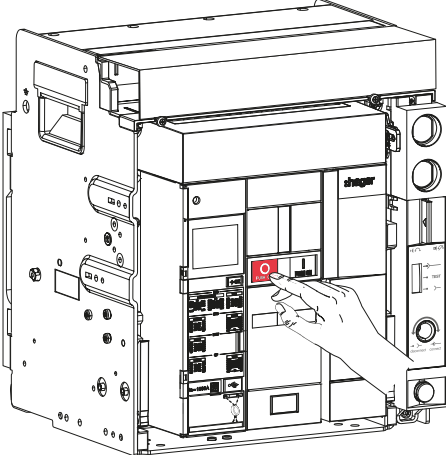
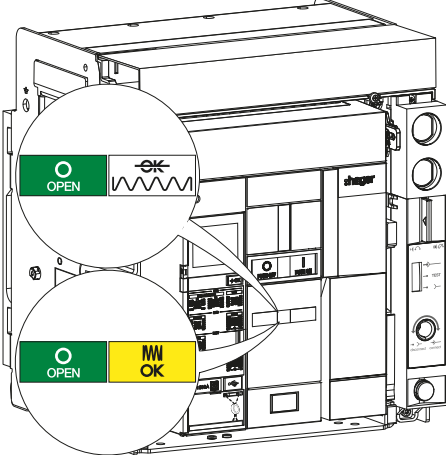
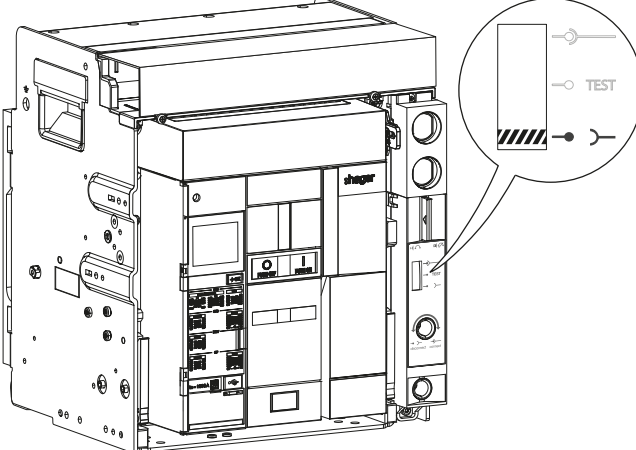

Action	Illustration
<p>1 (continued) Open the circuit breaker by pressing the opening push button</p> 	
<p>2 Check that the indicators change status.</p>	
<p>3 For the drawout circuit breaker, place the circuit breaker in the disconnected position (see Installation Manual 6LE007893A).</p>	

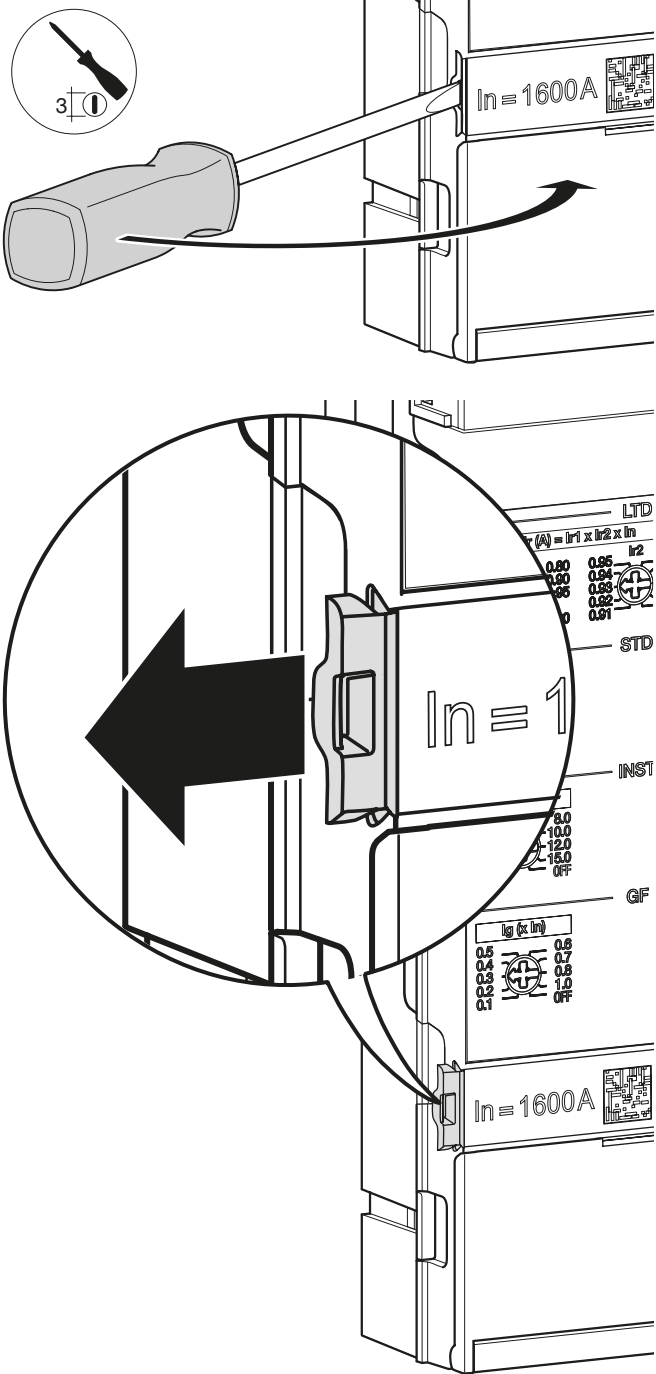
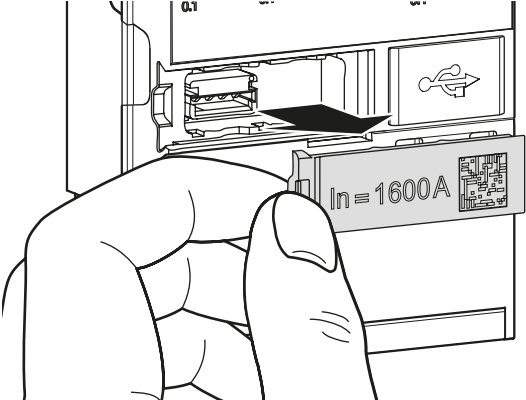
Action	Illustration
<p><b>4</b> If necessary, remove the seal from the transparent cover, which protects access to the trip unit, then unscrew the 4 screws.</p>	
<p><b>5</b> Lower the charging handle.</p>	
<p><b>6</b> Remove the cover in order to access the trip unit.</p>	

Action	Illustration
<p>7 Insert a flat screwdriver into the tab then apply leverage to unlock it.</p>	 <p>The illustration shows a flat screwdriver being inserted into a tab on the side of a rating plug. A circular inset provides a magnified view of the tab mechanism, with a large black arrow pointing to the left, indicating the direction to push the tab. The plug is labeled 'In = 1'. The background shows a panel with 'In = 1600A' and various technical specifications.</p>
<p>8 Remove the rating plug</p>	 <p>The illustration shows a hand pulling the rating plug out of the panel. The plug is labeled 'In = 1600A'. The background shows the panel with various technical specifications.</p>

Action	Illustration
<p>9 Position the tab of the new rating plug to the left.</p>	
<p>10 Insert the rating plug into its housing.</p>	
<p>11 Push the lever to the right to lock the rating plug.</p>	

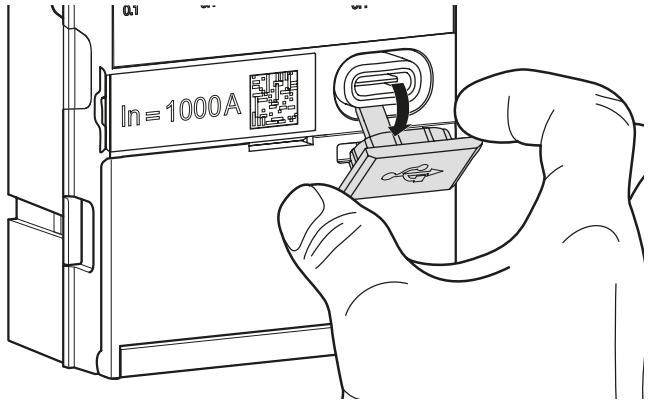
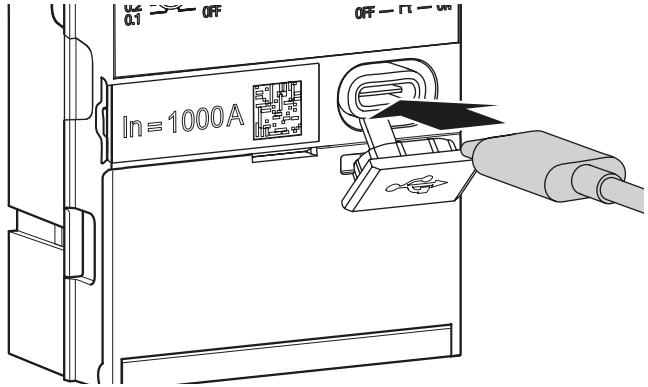
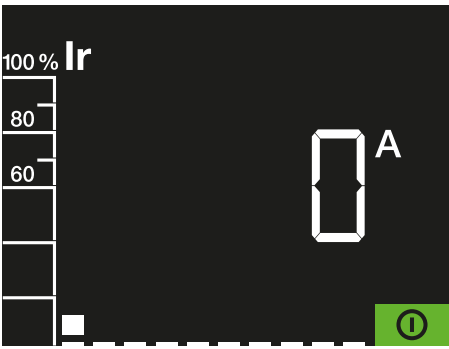

Action	Illustration
<p>12 Remove the USB-C port cover.</p>	
<p>13 Connect the external battery to the USB-C port.</p>	
<p>14 Check that there is no error and that the ReadyToProtect indicator appears on the electronic trip unit screen.</p>	
<p><b>ATTENTION</b></p>	
<p>If the E009 error code is displayed, the rating plug is faulty. Remove the external battery and replace the original rating plug or a new rating plug as described above. If the problem persists, contact your Hager representative or local Hager technical support (contact details for your country can be found on the Hager website).</p>	

Action	Illustration
<p>15 Remove the external battery.</p>	
<p>16 Close the USB-C port cover.</p>	
<p>17 Lower the charging handle.</p>	

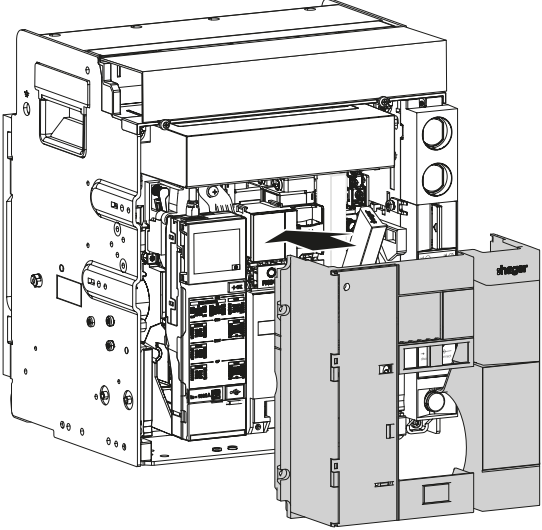
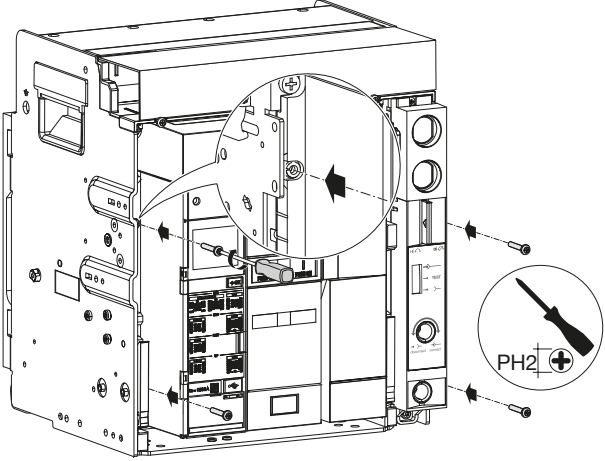
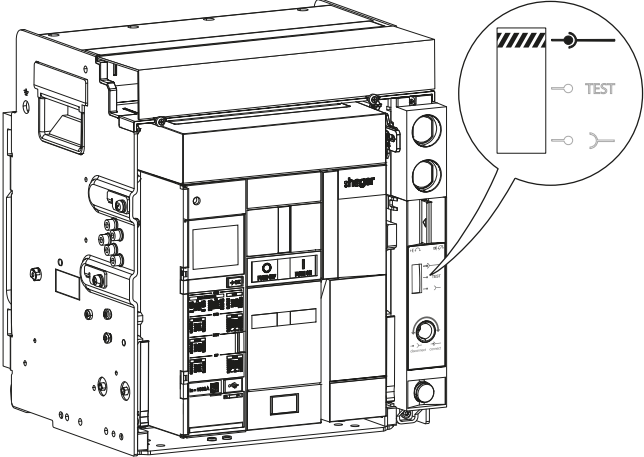
Action	Illustration
<p>18 Place the cover back to its position.</p>	
<p>19 Fix the 4 screws.</p>	
<p>20 For the drawout circuit breaker, place it in the connected position.</p>	

 **WARNING**

**Risk of unexpected operation.**  
Before closing the transparent cover, check the settings.

Action	Illustration
<p>21 Replace the transparent cover protecting access to the electronic trip unit if necessary.</p>	
<p>22 Charge the closing spring using the charging handle until the following indicators appear.</p>	
<p>23 Close the circuit breaker by pressing the closing push button</p> <div data-bbox="651 1328 799 1435" style="background-color: green; color: white; padding: 5px; display: inline-block; text-align: center;">   <b>PUSH ON</b> </div>	

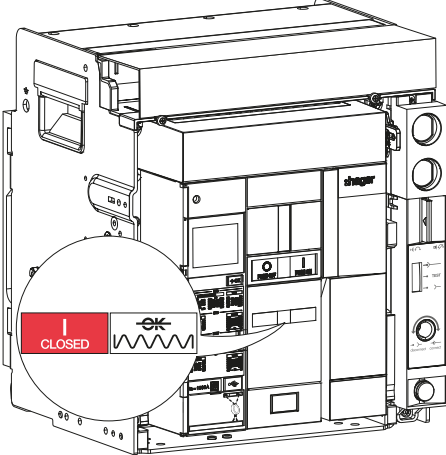
Action	Illustration
24 check that the indicators change status.	 A technical line drawing of a Hager circuit breaker assembly. The main drawing shows the front panel with a central door open, revealing internal components. A circular callout provides a magnified view of a specific indicator. This indicator is a rectangular window divided into two sections: the left section is red with the word 'CLOSED' in white, and the right section is white with a black wavy line and the letters 'OK' above it. The callout is positioned over the indicator on the internal assembly.







**Hager Electro SAS**  
132 Boulevard d'Europe  
BP3  
67210 OBERNAI CEDEX

[www.hager.com](http://www.hager.com)