

KNX Building system technology Flush mounted input device

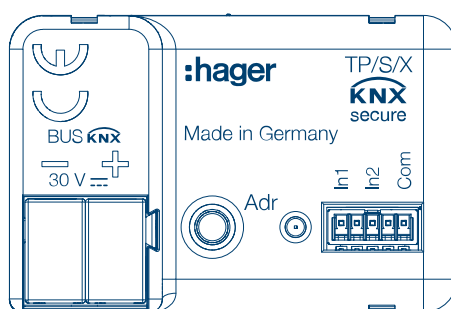







Flush mounted input device 2 -fold, 4 -fold
TYBS702A / TYBS704A

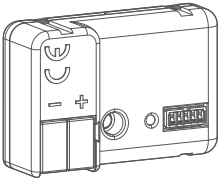

:hager

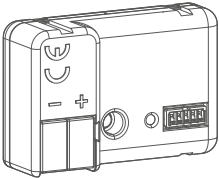
Product overview

Reference no.	Product designation	Application software ref.	TP device Radio device	 
	TYBS702A	Flush mounted input device 2 -fold, KNX Secure	STYBS702A	
	TYBS704A	Flush mounted input device 4 -fold, KNX Secure	STYBS704A	

Subject to technical changes!

Table of contents

1	Information on the product	3
1.1	Product catalogue	3
1.2	Product characteristics	3
1.3	Function	4
1.4	Device components	6
1.5	As-delivered state	7
1.6	Technical data	7
2	Safety instructions	8
3	Mounting and electrical connection	9
4	Commissioning	14
4.1	Safe-state mode	14
4.2	Master reset	14
4.3	Restoring the device to factory settings	15
4.4	Firmware update	15
5	Application programs	16
6	Scope of functions	17
7	General settings	20
8	Channel-oriented device functions	22
8.1	Push-button	23
8.1.2	Switching	25
8.1.3	Forced position	27
8.1.4	Dimming and colour temperature	30
8.1.5	Venetian blind / shutter / awning / roof window	39
8.1.6	Value transmitter	47
8.1.7	Scene extension	68
8.1.8	Short and long button actuation	71
8.1.9	Room temperature control point	97
8.2	Switch	111
8.2.2	Switching	113
8.2.3	Forced position	117
8.2.4	Value transmitter	121
8.2.5	Scene extension	139
8.2.6	Room temperature control point	144
8.3	Output	163
8.3.1	Applications	163

1 Information on the product

1.1 Product catalogue

Product name	Flush mounted input device 2 -fold
Order no.	TYBS702A
Use	Interface
Design	FM (flush-mounted)

Product name	Flush mounted input device 4 -fold
Order no.	TYBS704A
Use	Interface
Design	FM (flush-mounted)

1.2 Product characteristics

- Depending on the variant, two or four independent channels, which work as inputs or as outputs, depending on the ETS configuration
- Common reference potential for all channels
- Disabling of individual channels
- Supply via the KNX bus, no additional supply voltage necessary

Inputs

- Connection of potential-free contacts such as push-buttons, switches or Reed contacts
- Impulse current for avoiding contact fouling (image of an oxide layer) at the connected contacts
- Operating functions: switching, dimming, controlling of Venetian blinds, moods or room temperature
- Value transmitter for dimming, colour temperature, RGBW, temperature and brightness values
- Transmission of the current input state after bus voltage failure

Outputs

- Connection of LEDs
- Short-circuit resistant, overload-protected and reverse-polarity protected
- Switching outputs in parallel possible, for loads with higher energy consumption

1.3 Function

General

The device is compatible with KNX Data Secure products. KNX Data Secure offers protection against manipulation in building automation and can be configured in the ETS project. Detailed technical knowledge is required. A device certificate, which is attached to the device, is required for safe commissioning. During mounting, it is recommended to remove the certificate from the device and to store it securely.

The device can be updated. Firmware can be easily updated with the Hager/Berker Firmware Update App (additional software).

Function

The push-button interface has up to 4 independent channels. Each channel can be used as an input or output. The push-button interface can read in up to 4 contact states without potential via its inputs in event of a shared reference potential and transmit telegrams on the bus accordingly.

With the push-button connected, telegrams for switching, forced position, dimming the brightness or colour temperature, shading control, transmitting values, calling up or switching a scene as scene extension or operating a room temperature controller with the room temperature control point can be transmitted on the bus in the "push-button" channel function. Optionally, different telegrams can be transmitted on the bus by pressing the button briefly or for a long time. The contact type of the push-buttons can be parameterised in the process.

- i** The "push-button" channel function is recommended if telegrams are to be transmitted on the KNX, depending on how long the channel/push-button was actuated. For example in the "dimming", "venetian blind", "value transmitter with value adjustment", "telegram upon short or long button actuation" functions or with the "RGB(W) colour adjustment".

With the switch connected, telegrams for switching, forced position, transmitting values, calling up or switching a scene as scene extension or operating a room temperature controller with the room temperature control point can be transmitted on the bus by means of one or two objects in the "switch" channel function. One value can be parameterised when closing and one value when opening the contact.

- i** The "switch" channel function is recommended if telegrams are to be transmitted cyclically on the KNX. This allows monitoring, similar to the heartbeat, to be implemented or rising and falling edges - like with the switch - to be evaluated regardless of the time.

In the "output" channel function, the channels, as independent outputs, can actuate consumers, e. g. the corresponding LED (see chapter "Technical data" ▶ Page 7). To increase the output current, these channels can also be switched in parallel to each other with the same parameterisation. The outputs are short-circuit resistant, overload-protected and reverse-polarity protected.

- i** The connection of 230 V signals or other external voltages to the inputs is not permitted!

1.4 Device components

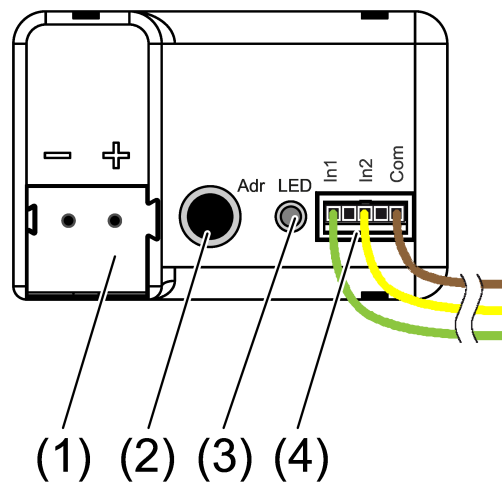

Figure 1: "2-gang" device variant

- (1) KNX connection
- (2) Programming button
- (3) Programming LED
- (4) Connecting cable

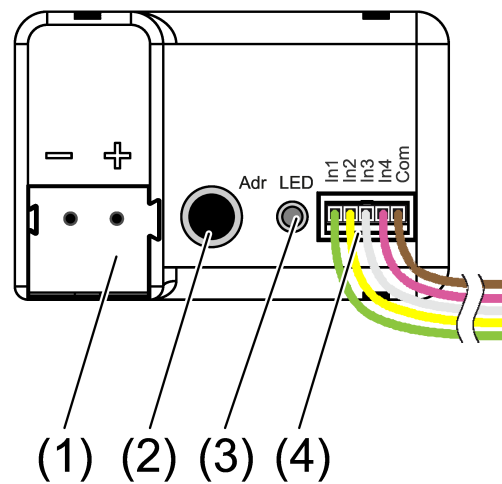

Figure 2: "4-gang" device variant

- (1) KNX connection
- (2) Programming button
- (3) Programming LED
- (4) Connecting cable

1.5 As-delivered state

The device is not functional when delivered. The device does not transmit any telegrams on the bus.

1.6 Technical data

Ambient temperature	-5 ... +45°C
Storage/transport temperature	-25 ... +75°C
Degree of protection	IP20
Protection class	III
Number of channels	
TYBS702A	2
TYBS704A	4
Output voltage	
TYBS702A, TYBS704A,	DC 3.3 V SELV
Output current per channel	
TYBS702A, TYBS704A,	max. 3.3 mA
LED current (red LED with 1.7 V current voltage)	
TYBS702A, TYBS704A,	1.6 mA per output
Connection of channels	
TYBS702A	3-core wiring harness
TYBS704A	5-core wiring harness
Length, wiring harness	
TYBS702A, TYBS704A,	25 cm, can be extended to max. 10 m
Recommended cable	J-Y(St)Y 2×2×0.8
Dimensions (LxWxH)	
TYBS702A, TYBS704A,	43.0 x 28.5 x 15.4 mm
KNX medium	TP256
Commissioning mode	S mode
Rated voltage KNX	DC 21 ... 32 V SELV
Connection mode KNX	Device connection terminal
Current consumption, KNX	
TYBS702A	4 ... 7 mA
TYBS704A	4 ... 9 mA

2 Safety instructions

To avoid potential damage, read and follow the following instructions:



Electrical devices may be mounted and connected only by electrically skilled persons.

Danger of electric shock. During installation and cable routing, comply with the regulations and standards which apply for SELV circuits.

Danger of electric shock. Make sure during the installation that there is always sufficient insulation between the mains voltage and the bus. A minimum distance of at least 4 mm must be maintained between bus conductors and mains voltage cores.

Danger of electric shock on the installation. Do not connect any external voltage to the inputs. The device might be damaged, and the SELV potential on the bus line will no longer be available.

This manual is an integral part of the product, and must remain with the customer.

3 Mounting and electrical connection

Mount device

In secure operation (preconditions):

- Secure commissioning is activated in the ETS.
- Device certificate entered/scanned or added to the ETS project. A high resolution camera should be used to scan the QR code.
- Document all passwords and keep them safe.
- In secure operation: device certificate must be removed from the device and stored securely.
- Mounting in suitable appliance box. Observe cable routing and spacing

Bus connection

- Connect a bus with a KNX device connection terminal to the KNX connector (1).

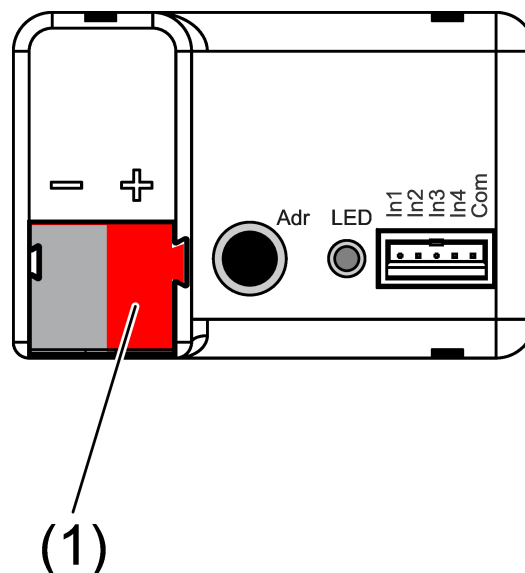

Figure 3: Bus connection

- (1) KNX connection

Installation instructions

- To avoid interference from EMC radiation, the cables of the inputs should not run parallel to cables carrying mains voltage or to load cables.
- The voltage potentials of the connecting cables for the inputs and outputs are not galvanically isolated from the bus voltage. The connecting cables actually lengthen the bus cable. The specification for the bus cable length (max. 1000 m) must be observed.
- Do not connect the **Com** connections of multiple push-button interfaces.
- No series resistance is required to connect suitable LEDs (see chapter "Technical data" ▶ Page 7).

When extending the supplied cable sets (see chapter "Technical data" ▶ Page 7), observe the maximum cable length l : max. 30 m. The COM cable for each cable set must not exceed the total maximum length of l .

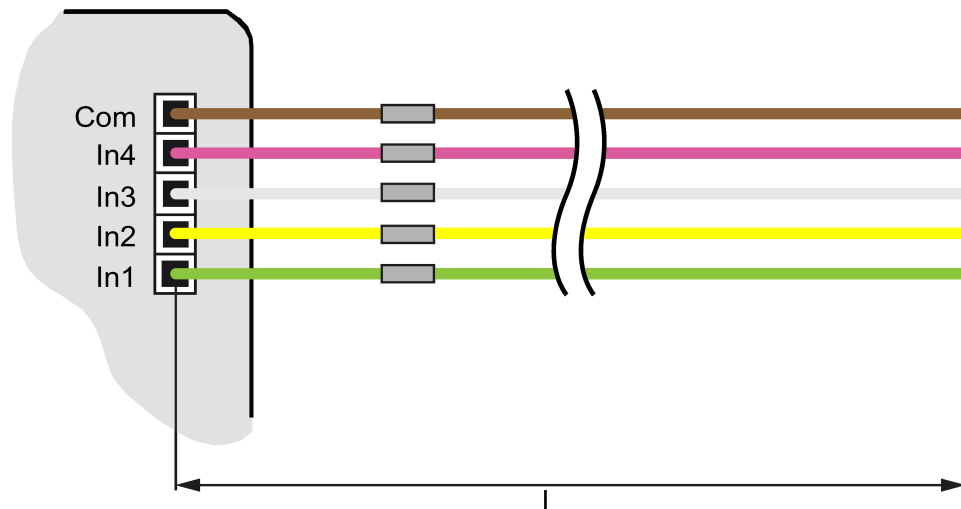

Figure 4: Maximum cable length



DANGER!

Danger of electrical shock when mains voltage 230 V or other external voltages are connected!

Electric shocks can be fatal.

Device may be destroyed.

Only connect potential-free push-buttons, switches or contacts.

- Connect push-buttons, switches, contacts or LED to enclosed connecting cables (4) according to the connection examples; (see figure 5) to (see figure 7). The connection examples show the use with inputs and outputs.

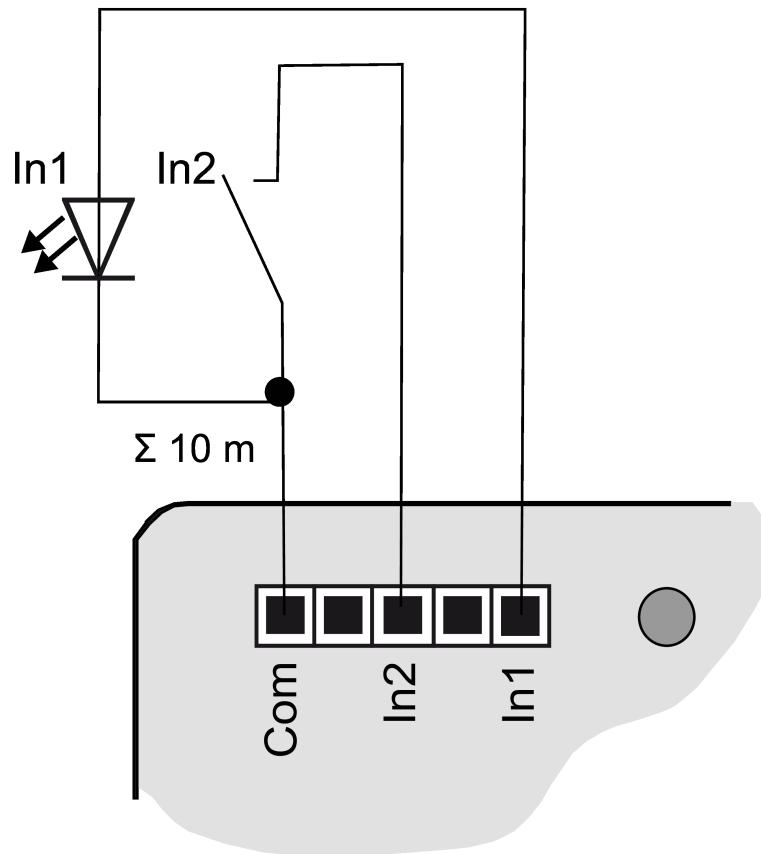

Figure 5: Connection example: push-button interface 2-gang

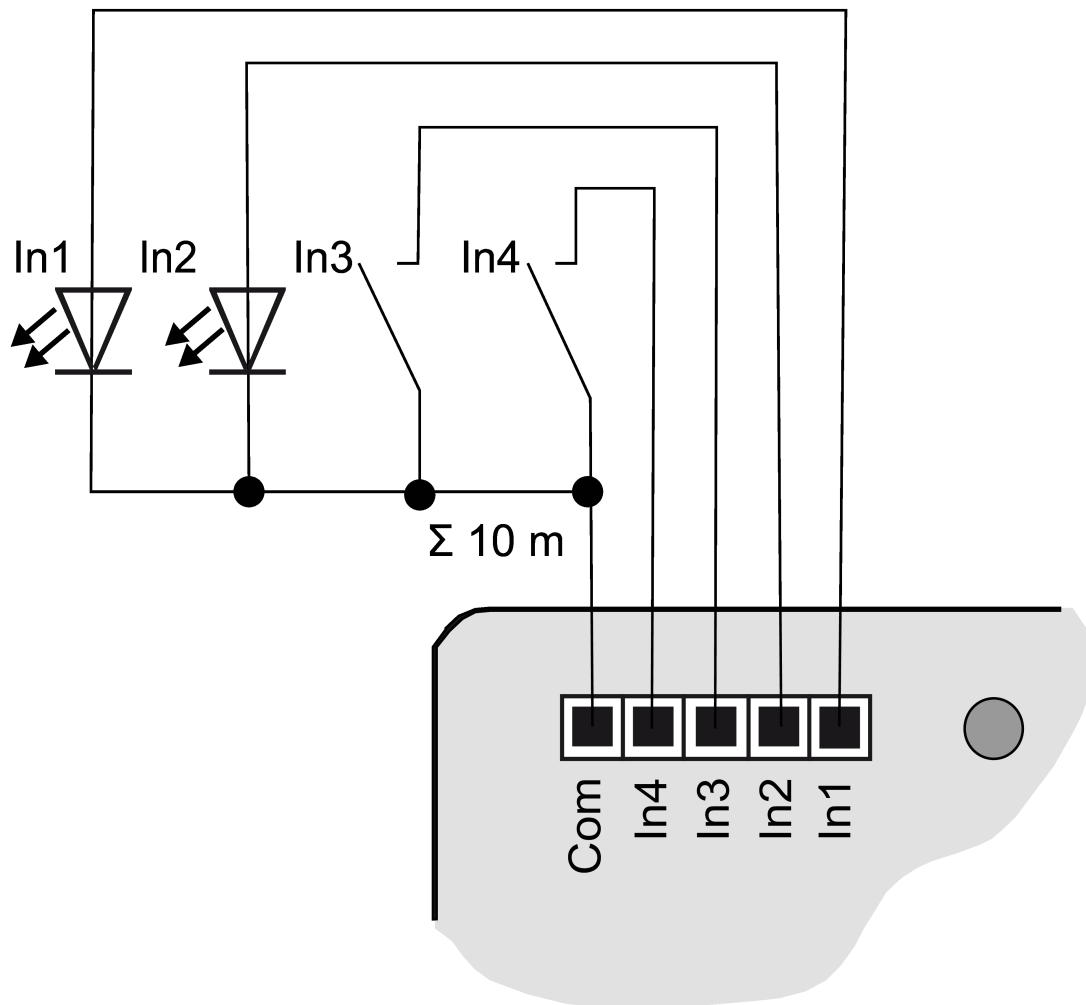

Figure 6: Connection example: push-button interface 4-gang

- i** To increase the output current, outputs can also be switched parallel to each other with the same parameterization; in the example here, (see figure 7) **In1-In3** are switched in parallel.

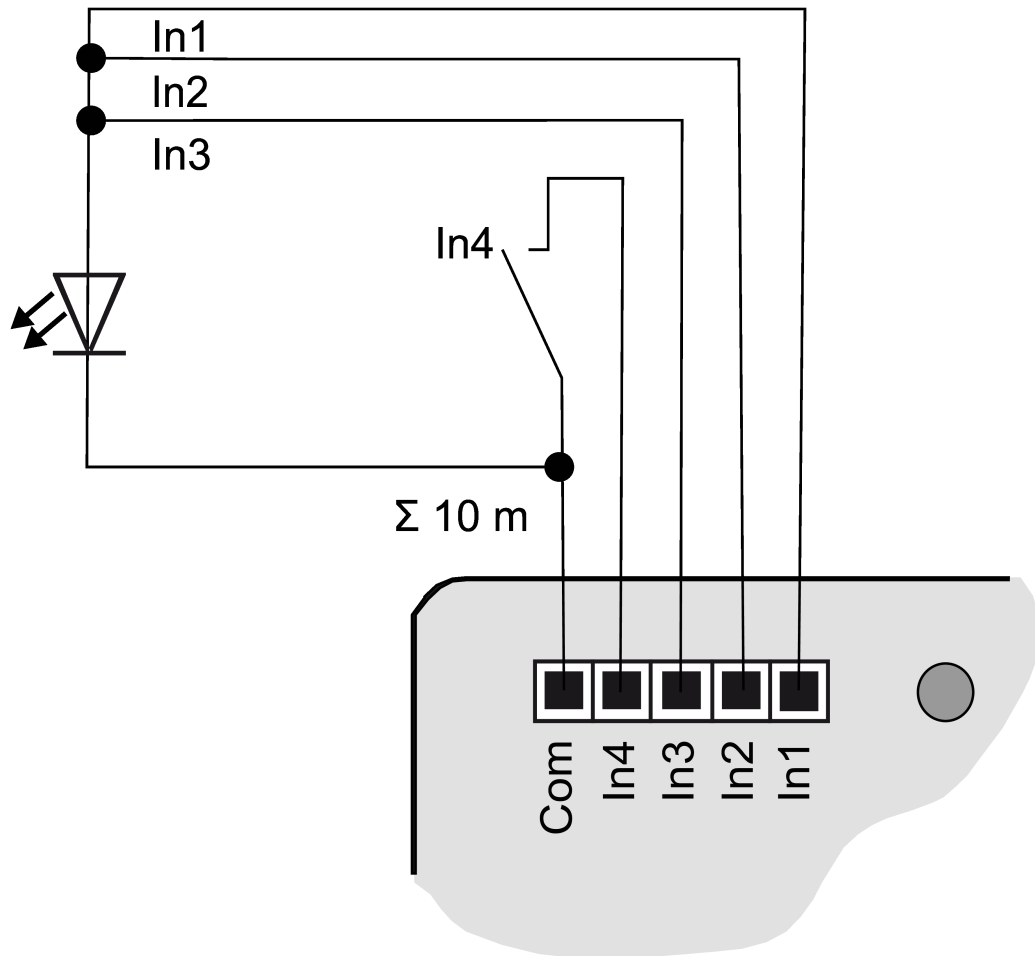

Figure 7: Connection example with outputs switched in parallel

4 Commissioning

Programming the physical address and application program

- Switch on the bus voltage.
- Press the programming button (2).
The programming LED (3) lights up.
- Program the physical address with the ETS.
The programming LED goes out.
- Program the application program with the ETS.

4.1 Safe-state mode

The safe-state mode stops the execution of the loaded application program.

-  Only the system software of the device is still functional. ETS diagnosis functions and programming of the device are possible.

Activating safe-state mode

- Switch off the bus voltage or remove the KNX device connection terminal.
- Wait approx. 10 seconds.
- Press and hold down the programming button.
- Switch on the bus voltage or attach the KNX device connection terminal.
- Wait until the programming LED flashes slowly.
- Release the programming button.

The safe-state mode is activated.

By briefly pressing the programming button again, the programming mode can also be switched on and off in the safe-state mode as usual. If the programming mode is active, the programming LED stops flashing.

Deactivating safe-state mode

- Switch off bus voltage (wait approx. 10 seconds) or carry out ETS programming.

4.2 Master reset

The master reset restores the basic device settings (physical address 15.15.255, firmware remains in place). The device must then be recommissioned with the ETS.

In secure operation: A master reset deactivates device security. The device can then be recommissioned with the device certificate.

Performing a master reset

Precondition: The safe-state mode is activated.

- Press and hold down the programming button for > 5 s.
The programming LED flashes quickly.
- Release the programming button.
The device performs a master reset, restarts and is ready for operation again after approx. 5 s.

4.3 Restoring the device to factory settings

The device can be reset to factory settings with the Hager/Berker Firmware Update App. This function uses the firmware contained in the device that was active at the time of delivery (delivered state). Restoring the factory settings causes the device to lose its physical address and configuration.

4.4 Firmware update

The device can be updated. Firmware can be easily updated with the Hager/Berker Firmware Update App (additional software).

5 Application programs

ETS search paths:	Inputs / 2-input modules embedded / Flush mounted input device 2 -fold Inputs / 4-input modules embedded / Flush mounted input device 4 -fold
Configuration:	S-mode standard

Application program available for Flush mounted input device 2 -fold

Name	STYBS702A
Version	2.1 for ETS from version 5.7.7 or 6.1.0
from mask version	07B0
Summarized description	Multifunctional ETS application for the Flush mounted input device 2 -fold. The ETS application supports KNX Data Secure. Each channel can be parameterised for different application cases. Optionally, logic functions can be configured.

Application program available for Flush mounted input device 4 -fold

Name	STYBS704A
Version	2.1 for ETS from version 5.7.7 or 6.1.0
from mask version	07B0
Summarized description	Multifunctional ETS application for the Flush mounted input device 4 -fold. The ETS application supports KNX Data Secure. Each channel can be parameterised for different application cases. Optionally, logic functions can be configured.

6 Scope of functions

General

- KNX Data Secure compatible
- Firmware updates are possible

Channel configuration

- Channels can be activated and deactivated individually

"Push-button" channel function

i The "push-button" channel function is recommended if telegrams are to be transmitted on the KNX, depending on how long the channel/push-button was actuated. For example in the "dimming", "venetian blind", "value transmitter with value adjustment", "telegram upon short or long button actuation" functions or with the "RGB(W) colour adjustment".

- The contact type can be set
- The function of the push-button can be set...

Switching

The command when pressing and/or releasing can be set (no reaction, switch on, switch off, toggle).

Forced position

The command when pressing and/or releasing can be set (no reaction; forcing active, switch on; forcing active, switch off; forcing inactive).

Dimming and colour temperature

The command when pressing the button, the time between switching and dimming, the dimming at different levels, the telegram repetition in the event of long actuation and the transmission of a stop telegram at the end of actuation can be set.

Venetian blind / shutter / awning / roof window

The command when pressing the button and the command sequence can be set.

Value transmitter

The data point type | value range and the value can be set. The value adjustment can optionally be activated by long button-actuation.

Scene extension

The scene number can be called up or switched over by briefly pressing the button. Optionally, the storage function is executed by pressing the button longer.

Short and long button actuation

Up to two telegrams can be transmitted on the KNX by pressing the button. The transmission behaviour can be set and the time for short and long actuation adjusted. The function of the channels is adjustable separately.

Room temperature control point

The functionality (operating mode switch-over, forced operating mode switch-over, presence function and setpoint temperature shift) can be set.

- The behaviour after the bus voltage returns can be set
- The disabling function can be set

The channel can be disabled by means of a 1-bit object. The following settings are possible: polarity of the disabling object, behaviour at the beginning and at the end of disabling. The channel is not functional during active disabling.

"Switch" channel function

i The "switch" channel function is recommended if telegrams are to be transmitted cyclically on the KNX. This allows monitoring, similar to the heartbeat, to be implemented or rising and falling edges - like with the switch - to be evaluated regardless of the time.

- The number of switch objects can be set
- Different switch functionalities can be parameterised for each object.

- The behaviour when closing the contact can be set
- The behaviour when opening the contact can be set
- The contact type can be set
- The function of the switch can be set...

- Switching

The command when closing and/or opening can be set (no reaction; switch on; switch off; toggle).

- Forced position

The command when closing and/or opening can be set (no reaction; forcing active, switch on; forcing active, switch off; forcing inactive).

- Value transmitter

The command when closing and/or opening can be set (no reaction, transmit value). The data point type | value range and the value can be set.

- Scene extension

The command when closing and/or opening can be set (call up scene, switch scenes). The scene number can be called up or switched over.

- Room temperature control point

The command when closing and/or opening can be set according to the functionality. The functionality (operating mode switch-over, forced operating mode switch-over, presence function and setpoint temperature shift) can be set.

- The behaviour after the bus voltage returns can be set
- Cyclical transmission can be set
- The disabling function can be set

The channel can be disabled by means of a 1-bit object. The following settings are possible: polarity of the disabling object, behaviour at the beginning and at the end of disabling. The channel is not functional during active disabling.

Output

- i** An LED lamp can be connected.
- i** Available only for a single channel.
 - Works in the switching function
 - The object polarity can be set

7 General settings

The "Information" parameter page provides information on the contact help, ETS compatibility and KNX Secure. No parameterisation is performed on this parameter page.

General settings of the push-button interface are parameterised and general functions enabled on the "General" parameter page.

Channel configuration

Each channel of the push-button interface can be activated and deactivated separately. Each channel can be operated and parameterised separately. Individual channels can execute the following channel functions:

- Push-button
- Switch
- Output

Times

A delay time after the bus voltage returns is always parameterised for the push-button interface on the "General" parameter page. The delay time after the bus voltage returns is preset to 5 seconds.

7.1 Table of parameters

The following parameters are available on the "General" parameter page.

Use (channel 1) (according to K3)	Active Inactive
<p>This parameter in the "Channel configuration" table activates or deactivates the first channel of the push-button interface.</p> <ul style="list-style-type: none"> - The channel is used in the "active" setting. - The channel is not used in the "inactive" setting. 	

Use (channel 2) (according to K4)	Active Inactive
<p>This parameter in the "Channel configuration" table activates or deactivates the second channel of the push-button interface.</p> <ul style="list-style-type: none"> - The channel is used in the "active" setting. - The channel is not used in the "inactive" setting. 	

Delay after bus voltage return	0 ... 59 min 0 ... 5 ... 59 s 0 ... 900 ms
<p>This parameter defines the delay time for the push-button interface after the bus voltage returns.</p> <p>The device behaves in a channel-oriented manner after the bus voltage returns, depending on the delay time set here.</p>	

The following parameters are available on the "Channel n -> K n - General" parameter page.

Name	Free text
<p>The text entered in this parameter is applied to the name of the communication objects and is used for labelling in the ETS parameter window.</p> <p>The text is not programmed in the device.</p>	

Channel function	Push-button Switch Output
<p>Each channel of the push-button interface can be activated and deactivated separately. Each channel can be operated and parameterised separately. The individual channels can execute the following channel functions:</p> <ul style="list-style-type: none"> - Push-button - Switch - Output 	

8 Channel-oriented device functions

The following subchapters provide a description of the device functions. Each subchapter consists of the following sections:

- Functional description
- Table of parameters
- Object list

Functional description

The functional description explains the function and provides helpful tips on project design and usage of the function. Cross references support you in your search for further information.

Table of parameters

The table of parameters lists all parameters associated with the function. Each parameter is documented in a table as follows.

Name of the parameter	Parameter values
Parameter description	

Object list

The object list specifies and describes all communication objects associated with the function. Each communication object is documented in a table.

Object no.	This column contains the object number of the communication object.
Function	This column contains the function of the communication object.
Name	This column contains the name of the communication object.
Type	This column contains the length of the communication object.
DPT	This column assigns a datapoint type to a communication object. Datapoint types are standardized in order to ensure interoperability of KNX devices.
Flag	This column assigns the communication flags in accordance with the KNX specification.
C flag	activates / deactivates the communication of the communication object
R flag	enables externally triggered reading of the value from the communication object
W flag	enables externally triggered writing of the value to the communication object
T flag	enables transfer of a value
U flag	enables updating of an object value in case of feedback
I flag	enforces updating of the communication object value when the devices is switched on (reading at init)

8.1 Push-button

The channel function can be parameterised for each channel. The following functions are available in the "push-button" channel function:

- Switching
- Forced position
- Dimming and colour temperature
- Venetian blind / shutter / awning / roof window
- Value transmitter
- Scene extension
- Short and long button actuation
- Room temperature control point

The ETS provides the corresponding parameters and communication objects dynamically for the function according to the parameterised function.

The contact type and debouncing time are to be parameterised separately for each channel. A disabling function can be activated optionally for each push-button channel.

i The "push-button" channel function is recommended if telegrams are to be transmitted on the KNX, depending on how long the channel/push-button was actuated. For example in the "dimming", "venetian blind", "value transmitter with value adjustment", "telegram upon short or long button actuation" functions or with the "RGB(W) colour adjustment".

8.1.1 Table of parameters

The following parameters are generally available for the "push-button" channel function.

Function	<p>Switching</p> <ul style="list-style-type: none"> Forced position Dimming and colour temperature Venetian blind / shutter / awning / roof window Value transmitter Scene extension Short and long button actuation Room temperature control point
<p>This parameter determines the function of the push-button connected to the channel.</p>	

Contact type	NO contact NC contact
This parameter determines the contact type of the push-button connected to the channel.	
Debounce time	4 ... 10 ... 255 ms
This parameter specifies the software debouncing time. A signal edge is evaluated at the input after a delay based on this time.	

8.1.2 Switching

In the "push-button" channel function, the push-button can be parameterised in the "switching" function. The ETS indicates up to three communication objects for each channel for the "switching" function. The parameters can be used to determine the value the "switching" object is to obtain when the push-button is pressed and/or released. Furthermore, the behaviour of the channel after the bus voltage returns can be parameterised and a disabling function activated. No distinction is made between a brief or long press.

8.1.2.1 Table of parameters

The following parameters are available in the "push-button" channel function with the parameterised "switching" function.

When pressed	no reaction ON OFF TOGGLE
This parameter defines the reaction when the push-button is pressed.	
When released	no reaction ON OFF TOGGLE
This parameter determines the reaction when the push-button is released.	
After bus voltage return	no reaction Transmit current state ON OFF
<p>This parameter determines the reaction after the bus voltage returns.</p> <p>Either no telegram, a telegram according to the current input state at the channel, an ON telegram or an OFF telegram is transmitted on the bus according to the parameterisation.</p> <p>The reaction after the bus voltage returns takes place only after the parameterised "delay after bus voltage returns" expires ("General" parameter page).</p>	
Disabling function	Inactive Active
This parameter enables the disabling function for the channel.	

At the beginning of the disabling function	no reaction ON OFF TOGGLE
<p>Besides disabling the channel, the device can immediately react when the disabling occurs.</p> <p>This parameter defines the reaction of the channel at the beginning of the disabling.</p>	
At the end of the disabling function	no reaction Transmit current state ON OFF TOGGLE
<p>Besides disabling the channel, the device can immediately react at the end of the disabling.</p> <p>This parameter defines the reaction of the channel at the end of the disabling.</p>	
Object polarity	0 = enabled / 1 = disable 1 = enabled / 0 = disable
<p>This parameter defines the value of the disabling object at which the disabling function is active.</p>	

8.1.2.2 Object list

The following communication objects are available in the "push-button" channel function with the parameterised "switching" function. The name can be adjusted with the "Name" parameter.

Object no.	Function	Name	Type	DPT	Flag
253, 261, ..., 277	Switching	K <i>n</i> - Output	1-bit	1,001	C, R, -, T, A
1-bit object for transmission of switching telegrams (ON, OFF).					

Object no.	Function	Name	Type	DPT	Flag
254, 262, ..., 278	Switching - Status	K <i>n</i> - Input	1-bit	1,001	C, -, W, -, U
1-bit object for receiving feedback telegrams (ON, OFF). This object is visible if the "When pressed" parameter or "When released" parameter is configured to "TOGGLE".					

Object no.	Function	Name	Type	DPT	Flag
255, 263, ..., 279	Switching - Disabling	K <i>n</i> - Input	1-bit	1,003	C, -, W, -, U
1-bit object for activating or deactivating the disabling function. The object polarity can be parameterised.					

8.1.3 Forced position

In the "push-button" channel function, the push-button can be parameterised for the "forced position" function. The ETS indicates up to two communication objects for each channel for the "forced position" function. The parameters can be used to determine the value the "forced position" object is to obtain when the push-button is pressed and/or released. Furthermore, the behaviour of the channel after the bus voltage returns can be parameterised and a disabling function activated. No distinction is made between a brief or long press.

8.1.3.1 Table of parameters

The following parameters are available in the "push-button" channel function with the parameterised "forced position" function.

When pressed	no reaction Forcing active, ON Forcing active, OFF Forcing inactive
--------------	---

This parameter defines the reaction when the push-button is pressed.

When released	no reaction Forcing active, ON Forcing active, OFF Forcing inactive
---------------	---

This parameter determines the reaction when the push-button is released.

After bus voltage return	no reaction Transmit current state Forcing active, ON Forcing active, OFF Forcing inactive
--------------------------	---

This parameter determines the reaction after the bus voltage returns.
 Either no telegram, a telegram according to the current input state at the channel, a forcing active ON telegram, a forcing active OFF telegram or a forcing inactive telegram is transmitted on the bus according to the parameterisation.
 The reaction after the bus voltage returns takes place only after the parameterised "delay after bus voltage returns" expires ("General" parameter page).

Disabling function	Inactive Active
--------------------	---------------------------

This parameter enables the disabling function for the channel.

At the beginning of the disabling function	no reaction Forcing active, ON Forcing active, OFF Forcing inactive
--	---

Besides disabling the channel, the device can immediately react when the disabling occurs.
 This parameter defines the reaction of the channel at the beginning of the disabling.

At the end of the disabling function	no reaction Transmit current state Forcing active, ON Forcing active, OFF Forcing inactive
Besides disabling the channel, the device can immediately react at the end of the disabling. This parameter defines the reaction of the channel at the end of the disabling.	
Object polarity	0 = enabled / 1 = disable 1 = enabled / 0 = disable
This parameter defines the value of the disabling object at which the disabling function is active.	

8.1.3.2 Object list

The following communication objects are available in the "push-button" channel function with the parameterised "forced position" function. The name can be adjusted with the "Name" parameter.

Object no.	Function	Name	Type	DPT	Flag
253, 261, ..., 277	Forced position	K n - Output	2-bit	2,001	C, R, -, T, A
<p>2-bit input object for activating and deactivating the forced position. With the value "1", bit 1 of the telegram activates the forced position. The assigned channels are then locked in the state specified by bit 0 ("0" = OFF / "1" = ON). The value "0" in bit 1 deactivates the forced position again.</p> <p>0x = forcing inactive 10 = forcing active, OFF 11 = forcing active, ON</p>					
Object no.	Function	Name	Type	DPT	Flag
255, 263, ..., 279	Forced position - Disabling	K n - Input	1-bit	1,003	C, -, W, -, U
<p>1-bit object for activating or deactivating the disabling function. The object polarity can be parameterised.</p>					

8.1.4 Dimming and colour temperature

In the "push-button" channel function, the push-button can be parameterised for the "dimming and colour control" function. The ETS indicates up to four communication objects for each channel for the "dimming and colour control" function. The parameters can be used to determine the value the objects "Dimming - ..." obtain when the button is pressed. Furthermore, the behaviour of the channel after the bus voltage returns can be parameterised and a disabling function activated.

Generally, the device transmits a switching telegram after a brief actuation and a dimming telegram after a long actuation. In the standard parameterisation the device transmits a telegram for stopping the dimming action after a long actuation. The duration of pressing the button between switching and dimming is 400 milliseconds in the default parameterisation and can be set in the advanced parameters. The brightness and/or the colour temperature can be dimmed.

- i The time between switching and dimming should be adjusted according to the parameterised debouncing time.

Status

If an actuator is controlled by multiple control points, the actuator must report its switching status back to the 1-bit object "Dimming - Switching - Status" of the channel. Due to the feedback, the device detects that the actuator has changed its switching status by input from another element and adjusts the dimming direction accordingly. The status is visible only if switchover commands are set.

- i** The dimming direction is always only evaluated and switched locally, unless the actuator changes its switching status due to input from multiple elements (e.g. lighting ON / change of brightness value only). The 4-bit dimming objects and the 3-byte combi object are not tracked via the bus.

Advanced configuration options

The device has advanced parameters for the dimming function. If necessary, these advanced parameters can be activated and thus be made visible.

In the continuous dimming mode (100%), the device transmits a telegram only at the beginning of the long press to start the dimming process and generally a stop telegram after the end of the press. For dimming in small levels it may be useful if the device repeats the dimming telegram in case of a sustained press for a presettable time (parameter "Telegram repetition"). The stop telegram after the end of the press is then not needed.

The following settings are made if the advanced parameters are switched to invisible (advanced parameters = inactive):

- Time between switching and dimming = 400 ms
- Dimming ranges = 100 %
- Stop telegram = active
- Telegram repetition = inactive

8.1.4.1 Brightness

The brightness is dimmed in the default configuration.

The control of the brightness in the "Dimming and colour temperature" function distinguishes between dual-area operation and single-area operation. The parameter "Brightness on pressing" defines the single-area or dual-area dimming function.

dual-area operation	single-area operation
Brighter (ON)	Brighter/darker (TOGGLE)
Darker (OFF)	Brighter (TOGGLE)
	Darker (TOGGLE)

With dual-area operation, the device transmits a telegram for switching on or off after a brief actuation, and a telegram for increasing the brightness ("Brighter") or dimming ("Darker") after a long actuation.

In the event of single-area operation, the device transmits ON and OFF telegrams alternately ("TOGGLE") each time the respective button is briefly pressed. If the button is pressed and held, the device transmits either a telegram for dimming up ("brighter") or down ("darker") or the "Brighter" and "Darker" telegrams alternately.

8.1.4.2 Colour temperature

The "Dimming and colour temperature" function with the control of the colour temperature distinguishes between dual-area operation and single-area operation. The parameter "Colour temperature on pressing" defines the single-surface or double-surface dimming function.

dual-area operation	single-area operation
Colder (ON)	Colder / warmer (TOGGLE)
Warmer (OFF)	Colder (TOGGLE)
	Warmer (TOGGLE)

In the event of dual-area operation, the device transmits a telegram for switching on or off after short actuation and a telegram for dimming to a colder or warmer colour temperature after long actuation.

In the event of single-area operation, the device transmits ON and OFF telegrams alternately ("TOGGLE") each time the respective button is briefly pressed. In the event of long actuation, the device transmits either a telegram for dimming colder or warmer or the "Colour temperature colder" and "Colour temperature warmer" telegrams alternately.

8.1.4.3 Brightness and colour temperature

The dimming process can only adjust either the brightness or the colour temperature via individual objects.

Optionally, the brightness and the colour temperature can also be adjusted together via a combi object.

The "Dimming and colour temperature" function with the control of the brightness and colour temperature distinguishes between dual-area operation and single-area operation. The parameter "Brightness + colour temperature on pressing" defines the single-area or dual-area dimming function.

dual-area operation	single-area operation
Brighter + colder (ON)	Brighter + colder / darker + warmer (TOGGLE)
Darker + warmer (OFF)	Brighter + colder (TOGGLE)
	Darker + warmer (TOGGLE)

In dual-area operation, the device sends a telegram for switching on or off in the event of brief actuation and a telegram for brighter/colder or darker/warmer dimming in the event of long actuation.

In the event of single-area operation, the device transmits ON and OFF telegrams alternately ("TOGGLE") each time the respective button is briefly pressed. In the event of long actuation, the device transmits either a telegram for brighter/colder dimming or darker/warmer dimming or the "Brighter + colder" and "Darker + warmer" telegrams alternately.

8.1.4.4 Table of parameters

The following parameters are available in the "push-button" channel function with the parameterised "Dimming and colour temperature" function.

Dimming control	Single object: brightness Single object: colour temperature Combi object: brightness + colour temperature
With this parameter, either the brightness or the colour temperature can be dimmed by means of an individual object, or the brightness and colour temperature can be controlled together by means of a combination object	
Brightness on pressing	no reaction Brighter (ON) Darker (OFF) Brighter/darker (TOGGLE) Brighter (TOGGLE) Darker (TOGGLE)
This parameter defines the reaction when a button is pressed. If the device is to toggle on a brief press, the corresponding switching objects of other sensors with the same function must be interlinked. This parameter is visible only if: dimming control = individual object: brightness	
Colour temperature on pressing	no reaction Colder (ON) Warmer (OFF) Colder / warmer (TOGGLE) Colder (TOGGLE) Warmer (TOGGLE)
This parameter defines the reaction when a button is pressed. If the device is to toggle on a brief press, the corresponding switching objects of other sensors with the same function must be interlinked. This parameter is visible only if: dimming control = individual object: colour temperature	

Brightness + colour temperature on pressing	no reaction Brighter + colder (ON) Darker + warmer (OFF) Brighter + colder / darker + warmer (TOGGLE) Brighter + colder (TOGGLE) Darker + warmer (TOGGLE)
---	---

This parameter defines the reaction when a button is pressed.
 If the device is to toggle on a brief press, the corresponding switching objects of other sensors with the same function must be interlinked.
 This parameter is visible only if: dimming control = combination object: brightness + colour temperature

Advanced parameters	Active Inactive
---------------------	---------------------------

When the advanced parameters are activated, the ETS shows the following parameters.

Time between switching and dimming	0 ... 50 s 100 ... 400 ... 990 ms
------------------------------------	--

This parameter defines how long the button must be pressed for a dimming telegram to be transmitted.

Increase brightness by	1.5 % 3 % 6 % 12.5 % 25 % 50 % 100 %
------------------------	---

This parameter sets the relative dimming level when the brightness is increased. On each button actuation, the brightness is changed at maximum by the configured step width.
 It is recommended that the device repeats the dimming telegrams automatically, particularly with a small dimming level (see "Telegram repetition").

Dimming darker by	1.5 % 3 % 6 % 12.5 % 25 % 50 % 100 %
<p>This parameter sets the relative dimming level when the brightness is reduced. On each button actuation, the brightness is changed at maximum by the configured step width.</p> <p>It is recommended that the device repeats the dimming telegrams automatically, particularly with a small dimming level (see "Telegram repetition").</p>	
Colour temperature colder by	1.5 % 3 % 6 % 12.5 % 25 % 50 % 100 %
<p>This parameter sets the relative dimming level when the colour temperature is increased. On each button actuation, the brightness is changed at maximum by the configured step width.</p> <p>It is recommended that the device repeats the dimming telegrams automatically, particularly with a small dimming level (see "Telegram repetition").</p>	
Colour temperature warmer by	1.5 % 3 % 6 % 12.5 % 25 % 50 % 100 %
<p>This parameter sets the relative dimming level when the colour temperature is reduced. On each button actuation, the brightness is changed at maximum by the configured step width.</p> <p>It is recommended that the device repeats the dimming telegrams automatically, particularly with a small dimming level (see "Telegram repetition").</p>	

Stop telegram	Active Inactive
<p>On "Active" the device transmits a telegram for stopping the dimming process when the button is released.</p> <p>When the device transmits telegrams for dimming in smaller levels, the stop telegram is generally not needed.</p>	
Telegram repetition	Active Inactive
<p>This parameter can be used to activate telegram repetition for dimming. With telegram repetition activated, the device cyclically sends relative dimming telegrams (in the parameterised step width) to the bus if the button is pressed long.</p>	
Time between two telegrams	200 ms 300 ms 400 ms 500 ms 750 ms 1000 ms 2000 ms
<p>This parameter defines the interval at which the dimming telegrams are automatically repeated in the telegram repetition mode.</p> <p>This parameter is only visible if "Telegram repetition = active"!</p>	
After bus voltage return	no reaction Transmit current state ON OFF
<p>This parameter determines the reaction after the bus voltage returns.</p> <p>Either no telegram, a telegram according to the current input state at the channel, an ON telegram or an OFF telegram is transmitted on the bus according to the parameterisation.</p> <p>The reaction after the bus voltage returns takes place only after the parameterised "delay after bus voltage returns" expires ("General" parameter page).</p>	
Disabling function	Inactive Active
<p>This parameter enables the disabling function for the channel.</p>	

At the beginning of the disabling function	no reaction ON OFF TOGGLE
Besides disabling the channel, the device can immediately react when the disabling occurs. This parameter defines the reaction of the channel at the beginning of the disabling.	
At the end of the disabling function	no reaction Transmit current state ON OFF TOGGLE
Besides disabling the channel, the device can immediately react at the end of the disabling. This parameter defines the reaction of the channel at the end of the disabling.	
Object polarity	0 = enabled / 1 = disable 1 = enabled / 0 = disable
This parameter defines the value of the disabling object at which the disabling function is active.	

8.1.4.5 Object list

The following communication objects are available in the "push-button" channel function with the parameterised "dimming and colour temperature" function. The name can be adjusted with the "Name" parameter.

Object no.	Function	Name	Type	DPT	Flag
317, 323, ..., 335	Dimming - Switching	K n - Output	1-bit	1,001	C, R, -, T, A
1-bit object for transmission of switching telegrams (ON, OFF).					

Object no.	Function	Name	Type	DPT	Flag
318, 324, ..., 336	Dimming - Brightness	K n - Output	4-bit	3,007	C, R, -, T, A
4-bit object for sending relative dimming telegrams to adjust the brightness.					

Object no.	Function	Name	Type	DPT	Flag
318, 324, ..., 336	Dimming - Brightness and colour temperature	K n - Output	3-byte	250,600	C, R, -, T, A
3-byte object for sending dimming telegrams for adjusting the brightness and the colour temperature in combination.					

Object no.	Function	Name	Type	DPT	Flag
319, 325, ..., 337	Dimming - Switching - Status	K n - Input	1-bit	1,001	C, -, W, -, U
1-bit object for receiving feedback telegrams (ON, OFF). This object is visible if the parameter " ... when pressed" is parameterised to "TOGGLE".					

Object no.	Function	Name	Type	DPT	Flag
320, 326, ..., 338	Dimming - Colour temperature	K n - Output	4-bit	3,007	C, R, -, T, A
4-bit object for sending relative dimming telegrams to adjust the colour temperature.					

Object no.	Function	Name	Type	DPT	Flag
321, 327, ..., 339	Dimming - Disabling	K n - Input	1-bit	1,003	C, -, W, -, U
1-bit object for activating or deactivating the disabling function. The object polarity can be parameterised.					

8.1.5 Venetian blind / shutter / awning / roof window

In the "push-button" channel function, the push-button can be parameterised for the "venetian blind / shutter / awning / roof window" function. The ETS indicates up to three communication objects for each channel for the "venetian blind / shutter / awning / roof window" function. The parameters can be used to determine the values the

"venetian blind" objects obtain when the push-button is pressed. Furthermore, the behaviour of the channel after the bus voltage returns can be parameterised and a disabling function activated.

The "Type of blind/shutter" parameter can be used to select whether "venetian blind" or "shutter / awning / skylight" are to be controlled. The selectable values of the "Command sequence" parameter vary, depending on the setting.

The "venetian blind / shutter / awning / skylight" function distinguishes between dual-area operation (UP, DOWN) and single-area operation (TOGGLE). The "Command on pressing" parameter defines the single-area or double-area blind function.

dual-area operation	single-area operation
UP	TOGGLE
DOWN	

Dual-area operation means that e.g. the device transmits a telegram for upward movement if one channel is actuated and a telegram for downward movement if a different channel is actuated.

Single-area operation means the device changes the direction of the long-time telegram after each long actuation. Several short time telegrams in succession have the same direction.

Status

If the actuator can be controlled from several sensors, a faultless single-area operation requires that the long time objects of the control elements are interlinked. The device would otherwise not be able to detect that the actuator has been addressed from another sensor, in which case it would have to be actuated twice during the next use in order to produce the desired reaction.

Operating concepts

For the control of venetian blind, roller shutter, awning or similar drives, the device supports four operating concepts in which the telegrams are transmitted in different time sequences. The device can therefore be used to operate a wide variety of drive configurations.

"Step - Up/down - Step" operating concept:

- i** The "Step - Up/down – Step" operating concept replaces the "Short - Long - Short" operating concept.

When selecting the operating concept "Step – Up/down – Step", the device behaves as follows:

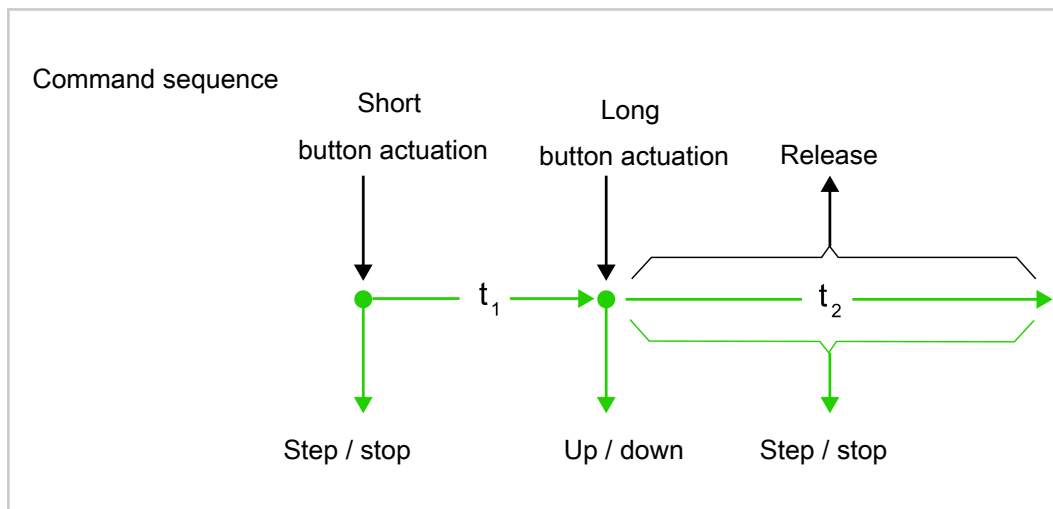

Figure 8: "Step - Up/down - Step" operating concept

- Immediately on pressing the button, the device transmits a short time telegram. This stops a running drive and starts the time t_1 ("long button actuation"). No other telegram will be sent if the button is released within t_1 . This short time serves the purpose of stopping a continuous movement. The time "long button actuation from" selected in the device should be shorter than the short time operation of the actuator to prevent jerky motion of the venetian blind.
- If the button is kept depressed for longer than t_1 , the push-button will send a long-time telegram at the end of t_1 to move the drive, and the time t_2 ("slat adjustment time window") will be started.
- If the button is released within the time window, the device will send another short-time telegram. This function is used for adjusting the slats of a venetian blind. The function permits stopping the slats in any position during their rotation. The "slat adjustment time window" should be chosen as required by the drive to completely rotate the slats. If the selected "slat adjustment time window" is longer than the complete running time of the drive, a pushbutton function is possible as well. This means that the drive is active only when the button is kept depressed.
- If the button is kept depressed for longer than t_2 , the device will not send another telegram. The drive remains on until the end position is reached.

"Up/down - Step" operating concept:

- i** The "Up/down – Step" operating concept replaces the "Long - Short" operating concept.

If the operating concept "Up/down – Step" is selected, the device behaves as follows:

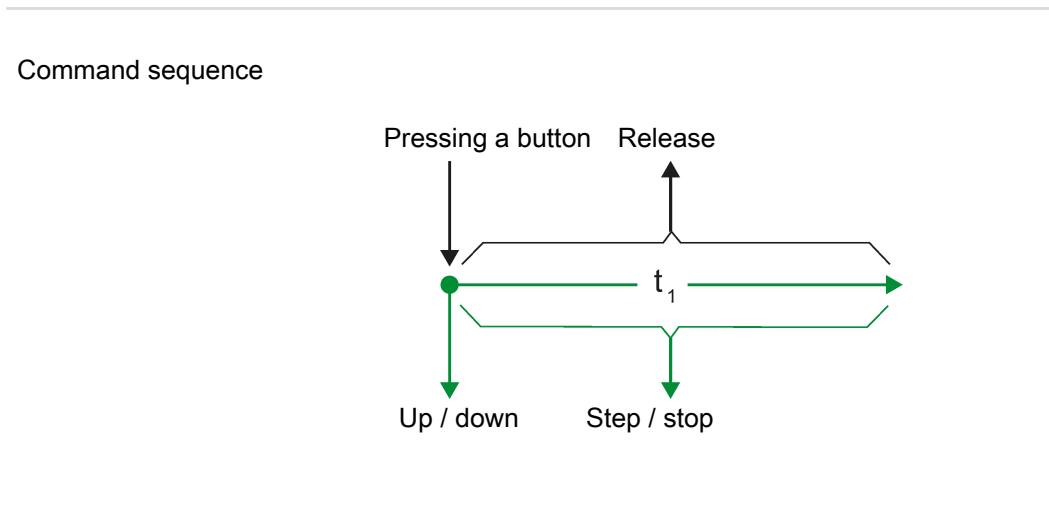

Figure 9: "Up/down - Step" operating concept

- Immediately on pressing the button, the device transmits a long time telegram. The drive begins to move and the time t_1 ("slat adjustment time window") is started.
- i** Venetian blind actuators should generate a break when changing the direction of travel to prevent motor damage.
- If the button is released within the slat adjustment time window, the device will send a short-time telegram. This function is used for adjusting the slats of a venetian blind. The function permits stopping the slats in any position during their rotation.
The "slat adjustment time window" should be chosen as required by the drive to completely rotate the slats. If the selected "slat adjustment time window" is longer than the complete running time of the drive, a pushbutton function is possible as well. This means that the drive is active only when the button is kept depressed.
- If the button is kept depressed for longer than t_1 , the device will not send another telegram. The drive remains on until the end position is reached.

"Step - Up/down" operating concept:

- i** The "Step - Up/down" operating concept replaces the "Short - Long" operating concept.

If the operating concept "Step – Up/down" is selected, the device will behave as follows:

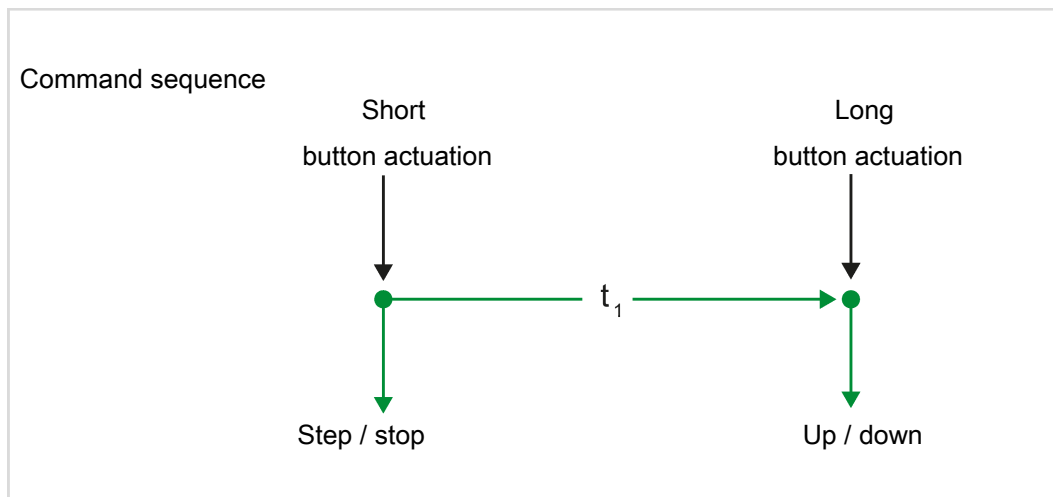

Figure 10: "Step - Up/down" operating concept

- Immediately on pressing the button, the device transmits a short time telegram. This stops a running drive and starts the time t_1 ("long button actuation"). No other telegram will be sent if the button is released within t_1 . This short time serves the purpose of stopping a continuous movement. The time "long button actuation from" selected in the device should be shorter than the short time operation of the actuator to prevent jerky motion of the venetian blind.
- If the button is kept depressed for longer than t_1 , the push-button will transmit a long-time telegram to start the drive at the end of t_1 .
- No further telegram is transmitted when the push-button is released. The drive remains on until the end position is reached.

"Up/down - Step or step" operating concept:

- i** The "Up/down – Step or step" operating concept replaces the "Long - Short or short" operating concept.

If the operating concept "Up/down – Step or step" is selected, the device will behave as follows:

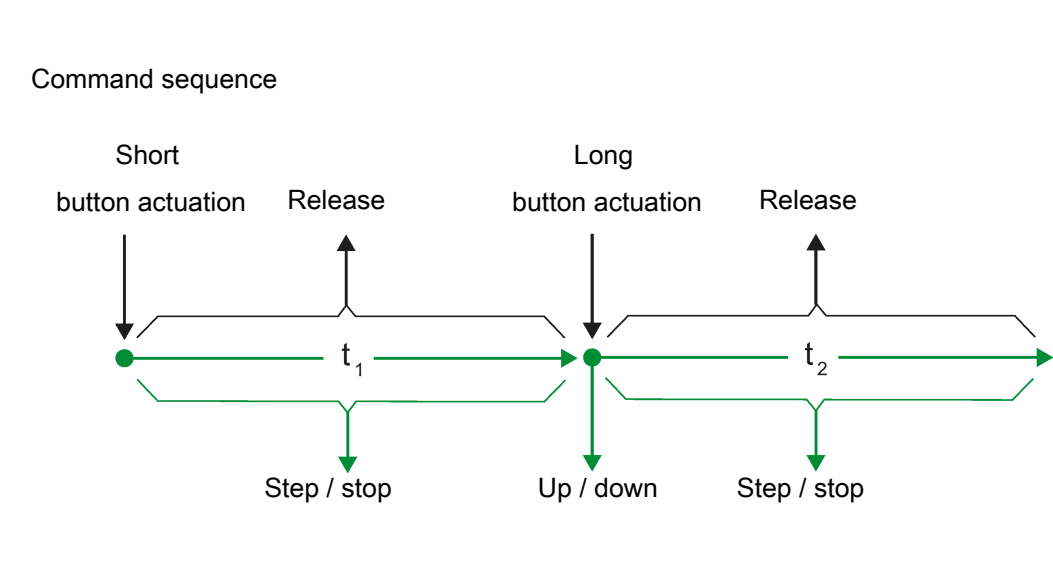

Figure 11: "Up/down – Step or step" operating concept

- Immediately after pressing the button, the device starts the time t_1 ("long button actuation") and waits. If the button is released again before t_1 expires, the device will send a short-time telegram. This telegram can be used to stop a running drive. A stationary drive rotates the slats by one level.
 - If the button is kept depressed after t_1 expires, the device will send a long-time telegram and start the time t_2 ("slat adjustment time window").
- i** Venetian blind actuators should generate a break when changing the direction of travel to prevent motor damage.
- If the button is released within t_2 , the device will send another short-time telegram. This function is used for adjusting the slats of a venetian blind. The function permits stopping the slats in any position during their rotation. The "slat adjustment time window" should be chosen as required by the drive to completely rotate the slats. If the selected "slat adjustment time window" is longer than the complete running time of the drive, a pushbutton function is possible as well. This means that the drive is active only when the button is kept depressed.
 - If the button is kept depressed for longer than t_2 , the device will not send another telegram. The drive remains on until the end position is reached.

8.1.5.1 Table of parameters

The following parameters are available in the "push-button" channel function with the parameterised function "venetian blind / shutter / awning / roof window".

Type of blind/shutter	Venetian blind Shutter / awning / roof window
This parameter defines the type of blind/shutter to be controlled and optimises the available setting options of the channel function.	
Command on pressing	UP DOWN TOGGLE
This parameter defines the running direction of the drive on pressing the button. If the setting is "TOGGLE", the direction is changed after each long time command. If several devices are to control the same drive, the long time objects of the devices must be interlinked to ensure that the running direction can be changed correctly.	
Command sequence	Up/down - Step Step - Up/down
Two different operating concepts can be selected to actuate the "shutter / awning / roof window" blind/shutter types.	
Command sequence	Step - Up/down - Step Up/down - Step Step - Up/down Step - Up/down or step
For venetian blind control, four different operating concepts can be selected.	
Long button actuation from (t1)	0 ... 59 s 100 ... 400 ... 990 ms
This parameter sets the time after which the long-time operation will be evaluated on pressing the button. This parameter is not visible for the "command sequence = Up/down - Step"	
Time window for slat adjustment (t2)	0 ... 59 s 0 ... 500 ... 990 ms
The time during which a transmitted MOVE telegram can be terminated by releasing the button (STEP) is set here. This function serves to adjust the slats of a venetian blind. This parameter is not visible for the "command sequence = Step - Up/down"	
Show info graphic	Active Inactive
If info graphic is activated, the graphic diagram of the command sequence and related text information are displayed.	

After bus voltage return	no reaction Transmit current state UP DOWN
<p>This parameter determines the reaction after the bus voltage returns.</p> <p>Either no telegram, a telegram according to the current input state at the channel, an UP telegram or a DOWN telegram is transmitted on the bus according to the parameterisation.</p> <p>The reaction after the bus voltage returns takes place only after the parameterised "delay after bus voltage returns" expires ("General" parameter page).</p>	
Disabling function	Inactive Active
<p>This parameter enables the disabling function for the channel.</p>	
At the beginning of the disabling function	no reaction UP DOWN
<p>Besides disabling the channel, the device can immediately react when the disabling occurs.</p> <p>This parameter defines the reaction of the channel at the beginning of the disabling.</p>	
At the end of the disabling function	no reaction Transmit current state UP DOWN
<p>Besides disabling the channel, the device can immediately react at the end of the disabling.</p> <p>This parameter defines the reaction of the channel at the end of the disabling.</p>	
Object polarity	0 = enabled / 1 = disable 1 = enabled / 0 = disable
<p>This parameter defines the value of the disabling object at which the disabling function is active.</p>	

8.1.5.2 Object list

The following communication objects are available in the "push-button" channel function with the parameterised function "venetian blind / shutter / awning / roof window". The name can be adjusted with the "Name" parameter.

Object no.	Function	Name	Type	DPT	Flag
365, 369, ..., 377	Venetian blind - Short time operation	K <i>n</i> - Output	1-bit	1,007	C, R, -, T, A
1-bit object for the transmission of telegrams with which a venetian blind or shutter drive motor can be stopped or with which the blind slats can be adjusted by short time operation.					

Object no.	Function	Name	Type	DPT	Flag
366, 370, ..., 378	Venetian blind - Long time operation	K <i>n</i> - Output	1-bit	1,008	C, R, W, T, A
1-bit object for the transmission of telegrams with which a venetian blind or shutter drive motor can be moved upwards or downwards.					

Object no.	Function	Name	Type	DPT	Flag
367, 371, ..., 379	Venetian blind - Disabling	K <i>n</i> - Input	1-bit	1,003	C, -, W, -, U
1-bit object for activating or deactivating the disabling function. The object polarity can be parameterised.					

8.1.6 Value transmitter

In the "push-button" channel function, the push-button can be parameterised for the "value transmitter" function. The ETS indicates up to six communication objects for each channel for the "value transmitter" function. The parameters can be used to determine the value the "value transmitter" objects obtain when the button is pressed.

With the "Value transmitter" function, the device sends parameterised values to the bus at the press of a button.

Value adjustment

Furthermore, a value adjustment and the behaviour of the channel after the bus voltage returns can be parameterised and a disabling function activated. No distinction is made between a brief or long press.

In the function as value transmitter with value adjustment, the device transmits the parameterised value when the button is briefly pressed. After the initial value adjustment, the device still transmits the parameterised value or the device takes the value to be transmitted depending on the parameterisation from the value adjustment or from the status object if the button is briefly pressed. This allows fixed or changeable values or values transmitted via the bus to be called up.

Optionally, the channel adjusts the value if the button is pressed for a long time. This allows, for example, absolute dimming of the values to be generated. The direction of the value adjustment can be parameterised in the process. The value adjustment can be configured flexibly by allowing the starting time in the event of pressing the button for a long time and the time between the telegrams to be parameterised.

- i** The value adjustment is not available, with "DPT 249.600 | colour temperature value + brightness" and "RGBW/HSVW colour value".

Value ranges

The value transmitter knows 14 different value ranges. The parameter "Data point type | Value range" determines the value range used by the value transmitter, depending on the application case:

Function	Function	Lower numerical limit	Upper numerical limit
1-byte value transmitter	0...100%	0%	100%
1-byte value transmitter	0...255	0	255
1-byte value transmitter	0...360°	0°	360°
1-byte value transmitter	0...255%	0%	255%
1-byte value transmitter	-128...127	-128	127
2-byte value transmitter	0...65535	0	65535
2-byte value transmitter	Colour temperature value	1000 K	10000 K
2-byte value transmitter	-32768...32767	-32768	32767
2-byte value transmitter	Temperature value	0°C	40°C
2-byte value transmitter	Brightness value	0 lux	1500 lux
6-byte value transmitter	Colour temperature value + brightness	1000 K 0%	10000 K 100%
3-byte value transmitter	RGB/HSV with colour wheel sequence	#000000	#FFFFFF
3-byte value transmitter	RGB/HSV with brightness adjustment	#000000	#FFFFFF
6-byte value transmitter	Colour value RGBW/HSVW	#000000 + 0	#FFFFFF + 255

For each of these ranges, the value that can be transmitted to the bus for each button actuation is configurable.

8.1.6.1 Table of parameters

The following parameters are available in the "push-button" channel function with the parameterised "value transmitter" function.

Data point type Value range	<p>DPT 5.001 0 ... 100%</p> <p>DPT 5.010 0 ... 255</p> <p>DPT 5.003 0 ... 360°</p> <p>DPT 5.004 0 ... 255%</p> <p>DPT 6.010 -128 ... 127</p> <p>DPT 7.001 0 ... 65535</p> <p>DPT 7.600 1000 ... 10000 K</p> <p>DPT 8.001 -32768 ... 32767</p> <p>DPT 9.001 0 ... 40°C</p> <p>DPT 9.004 0 ... 1500 lux</p> <p>DPT 249.600 Colour temperature value + brightness</p> <p>RGB/HSV with colour wheel sequence (RGB: DPT 232.600, HSV: DPT 5.003, DPT 5.001, DPT 5.001)</p> <p>RGB/HSV with brightness adjustment (RGB: DPT 232.600, HSV: DPT 5.003, DPT 5.001, DPT 5.001)</p> <p>Colour value RGBW/HSVW (RGBW: DPT 251.600, HSVW: DPT 5.003, DPT 5.001, DPT 5.001, DPT 5.001)</p>
-------------------------------	---

The "value transmitter" function distinguishes between 1-byte, 2-byte 3-byte and 6-byte values.

The following parameters and their settings depend on the setting for this parameter.

Value when pressed	0 ... 100%
This parameter defines the object value when the button is pressed. It is visible only if "data point type value range = DPT 5.001 0 ... 100%".	
Value when pressed	0 ... 255
This parameter defines the object value when the button is pressed. It is visible only if "data point type value range = DPT 5.010 0 ... 255".	
Value when pressed	0 ... 360°
This parameter defines the object value when the button is pressed. It is visible only if "data point type value range = DPT 5.003 0 ... 360°".	

Value when pressed	0 ... 255%
This parameter defines the object value when the button is pressed. It is visible only if "data point type value range = DPT 5.004 0 ... 255%".	
Value when pressed	-128...0 ...127
This parameter defines the object value when the button is pressed. It is visible only if "data point type value range = DPT 6.010 -128 ... 127".	
Value when pressed	0 ... 65535
This parameter defines the object value when the button is pressed. It is visible only if "data point type value range = DPT 7.001 0 ... 65535".	
Colour temperature value when pressed	1000 ... 2700 ... 10000 K
This parameter defines the object value when the button is pressed. It is visible only if "data point type value range = DPT 7.600 1000 ... 10000 K".	
Value when pressed	-32768 ... 0 ... 32767
This parameter defines the object value when the button is pressed. It is visible only if "data point type value range = DPT 8.001 -32768 ... 32767".	
Temperature value when pressed	0 ... 20 ... 40°C
This parameter defines the object value when the button is pressed. It is visible only if "data point type value range = DPT 9.001 0 ... 40°C".	
Brightness value when pressed	0, 50 ... 300 ... 1500 lux
This parameter defines the object value when the button is pressed. It is visible only if "data point type value range = DPT 9.004 0 ... 1500 lux".	
Colour temperature value when pressed	1000 ... 2700 ... 10000 K
This parameter defines the object value when the button is pressed. It is visible only if "data point type value range = DPT 249.600 colour temperature value + brightness".	
Brightness value when pressed	0 ... 100%
This parameter defines the object value when the button is pressed. It is visible only if "data point type value range = DPT 249.600 colour temperature value + brightness".	
Adjustment duration in the actuator	0 ... 100 min, 0, 1 ... 59 s, 0 ... 900 ms
This parameter defines the object value when the button is pressed. It is visible only if "data point type value range = DPT 249.600 colour temperature value + brightness".	

Colour value when pressed	#000000 ... #FFFFFF
<p>This parameter determines the object values of the value transmitter 3-byte (or value transmitter 6-byte), brightness value (V), saturation (S) and colour hue (H) objects when the button is pressed.</p> <p>It is visible with "data point type value range = RGB/HSV with colour wheel sequence (RGB: DPT 232.600, HSV: DPT 5.003, DPT 5.001, DPT 5.001)", "data point type value range = RGB/HSV with brightness adjustment (RGB: DPT 232.600, HSV: DPT 5.003, DPT 5.001, DPT 5.001)" and "data point type value range = colour value RGBW/HSVW (RGBW: DPT 251.600, HSVW: DPT 5.003, DPT 5.001, DPT 5.001, DPT 5.001)".</p> <p>The value (RGB/HSV) is configured by means of a colour picker.</p> <p>With the data point type value range "colour value RGBW/HSVW (RGBW: DPT 251.600, HSVW: DPT 5.003, DPT 5.001, DPT 5.001, DPT 5.001)", the white value is configured by means of a separate slider.</p>	
White value when pressed	0 ... 255
<p>This parameter defines the object value of the white level (W) object when the button is pressed.</p> <p>It is visible only if "data point type value range = colour value RGBW/HSVW (RGBW: DPT 251.600, HSVW: DPT 5.003, DPT 5.001, DPT 5.001, DPT 5.001)".</p>	
Value adjustment	Active Inactive
<p>In the "push-button" channel function, the device can adjust the value in the "value transmitter" function.</p> <p>If the value adjustment is activated by a long button-press, the ETS shows further parameters.</p> <p>i The value adjustment is not available, with "DPT 249.600 colour temperature value + brightness" and "RGBW/HSVW colour value".</p>	
Start value	same as configured value Same as value after last adjustment Like value from status object
<p>Value adjustment can begin with different starting values.</p> <p>With "same as configured value": After each long press, the device always starts with the value configured in the ETS.</p> <p>With "same as value after last adjustment": After a long press, the device starts with the value transmitted by itself or by another device with this group address as the last value.</p> <p>With "same as value from status object": When the push-button is pressed for a long time, the device starts with the value that it or another device with this group address transmitted as the last value.</p> <p>i This selection is available only with 1-byte or 2-byte value transmitters.</p>	

Start value	As parameterised colour value Same as value after last adjustment As value from status object colour angle (H) Like value from status object RGB
Value adjustment can begin with different starting values. With "same as parameterised colour value": After each long actuation, the device always starts with the value programmed by the ETS. With "same as value after last adjustment": After a long press, the device starts with the value transmitted by itself or by another device with this group address as the last value. With "same as value from colour hue (H) status object": After long actuation, the device starts with the value that it or another device with this group address transmitted as the last value. With "same as value from RGB status object": After long actuation, the device starts with the value that it or another device with this group address transmitted as the last value. ⓘ This selection is available only with RGB/HSV with colour wheel sequence.	

Start value	As parameterised colour value Same as value after last adjustment As value from status object brightness (V) Like value from status object RGB
Value adjustment can begin with different starting values. With "same as parameterised colour value": After each long actuation, the device always starts with the value programmed by the ETS. With "same as value after last adjustment": After a long press, the device starts with the value transmitted by itself or by another device with this group address as the last value. With "same as value from brightness (V) status object": After long actuation, the device starts with the value that it or another device with this group address transmitted as the last value. With "same as value from RGB status object": After long actuation, the device starts with the value that it or another device with this group address transmitted as the last value. ⓘ This selection is available only with RGB/HSV with brightness adjustment.	

Direction	Upwards Downwards Toggleing (alternating)
With a long press, the device can either vary the values always in the same direction or it stores the direction of the last adjustment and reverses it on the next button-press.	
i This selection is available only with 1-byte or 2-byte value transmitters.	

Direction	Colour sequence in clockwise direction (red -> green -> blue -> red -> ...) Colour sequence in anti-clockwise direction (red -> blue -> green -> red -> ...) Toggleing colour sequence (alternating with each new rising edge)
With a long press, the device can either vary the values always in the same direction or it stores the direction of the last adjustment and reverses it on the next button-press.	
i This selection is available only with RGB/HSV with colour wheel sequence.	

Direction	Brighter Darker Toggleing (alternating)
With a long press, the device can either vary the values always in the same direction or it stores the direction of the last adjustment and reverses it on the next button-press.	
i This selection is available only with RGB/HSV with brightness adjustment.	

Increment	1 ... 15
In a value adjustment, the device determines the new telegram value from the previous value and the preset step width. If the value falls below the lower limit of the adjustment range or if it exceeds the upper limit, the sensor adapts the step width of the last step automatically.	
i This selection is available only with 1-byte value transmitters.	

Increment	1, 2, 5, 10, 20, 50, 75, 100 , 200, 500, 750, 1000
In a value adjustment, the device determines the new telegram value from the previous value and the preset step width. If the value falls below the lower limit of the adjustment range or if it exceeds the upper limit, the sensor adapts the step width of the last step automatically.	
i This selection is available only with 2-byte value transmitters (0 ... 65535 and -32768 ... 32767) available.	

Increment	0.5, 1, 1.5, 2, ..., 40
<p>In a value adjustment, the device determines the new telegram value from the previous value and the preset step width. If the value falls below the lower limit of the adjustment range or if it exceeds the upper limit, the sensor adapts the step width of the last step automatically.</p> <p>i This selection is available only with 2-byte value transmitters (0 ... 40°C).</p>	
Increment	1, 10, 20, ..., 500 , ..., 1000
<p>In a value adjustment, the device determines the new telegram value from the previous value and the preset step width. If the value falls below the lower limit of the adjustment range or if it exceeds the upper limit, the sensor adapts the step width of the last step automatically.</p> <p>i This selection is available only with 2-byte value transmitters (1000 ... 10000 K).</p>	
Increment	1, 2, 3, ..., 50 , ..., 1500 lux
<p>In a value adjustment, the device determines the new telegram value from the previous value and the preset step width. If the value falls below the lower limit of the adjustment range or if it exceeds the upper limit, the sensor adapts the step width of the last step automatically.</p> <p>i This selection is available only with 2-byte value transmitters (0 ... 1500 lux).</p>	
Increment	1, 2, 4, 5, 10, 20, 25, 30, 50, 60 °
<p>In a value adjustment, the device determines the new telegram value from the previous value and the preset step width. If the value falls below the lower limit of the adjustment range or if it exceeds the upper limit, the sensor adapts the step width of the last step automatically.</p> <p>i This selection is available only with 3-byte value transmitters (RGB/HSV).</p>	
Value adjustment starts after	0.5 s after pressing the button 1 s after pressing the button 2 s after pressing the button 3 s after pressing the button 5 s after pressing the button
<p>This parameter determines the time from when the device starts the value adjustment after a key is pressed.</p>	
Time between two telegrams	0.5 s 1 s 2 s 3 s
<p>This parameter defines the interval at which the device transmits new telegrams during a value adjustment.</p>	

Value adjustment with overflow	Active Inactive
<p>If value adjustment is to be effected without overflow (setting "inactive") and if the device reaches the lower limit of the adjustment range or the upper limit during value adjustment, the adjustment will be stopped automatically by the sensor.</p> <p>If the value adjustment with overflow is programmed (setting "active") and if the device reaches the lower or the upper limit, it will transmit the value of this range limit and then add a pause the duration of which corresponds to two levels. Thereafter, the device transmits a telegram with the value of the other range limit and continues the value adjustment in the same direction.</p>	
After bus voltage return	no reaction Transmit current state Transmit value
<p>This parameter determines the reaction after the bus voltage returns.</p> <p>Either no telegram, a telegram according to the current input state at the channel or a value parameterised accordingly for the set data point type value range is transmitted on the bus.</p> <p>The reaction after the bus voltage returns takes place only after the parameterised "delay after bus voltage returns" expires ("General" parameter page).</p>	
Value	0 ... 100%
<p>This parameter determines the object value after the bus voltage returns.</p> <p>It is visible only if "data point type value range = DPT 5.001 0 ... 100%".</p>	
Value	0 ... 255
<p>This parameter determines the object value after the bus voltage returns.</p> <p>It is visible only if "data point type value range = DPT 5.010 0 ... 255".</p>	
Value	0 ... 360°
<p>This parameter determines the object value after the bus voltage returns.</p> <p>It is visible only if "data point type value range = DPT 5.003 0 ... 360°".</p>	
Value	0 ... 255%
<p>This parameter determines the object value after the bus voltage returns.</p> <p>It is visible only if "data point type value range = DPT 5.004 0 ... 255%".</p>	
Value	-128...0 ... 127
<p>This parameter determines the object value after the bus voltage returns.</p> <p>It is visible only if "data point type value range = DPT 6.010 -128 ... 127".</p>	
Value	0 ... 65535
<p>This parameter determines the object value after the bus voltage returns.</p> <p>It is visible only if "data point type value range = DPT 7.001 0 ... 65535".</p>	

Colour temperature value	1000 ... 2700 ... 10000 K
This parameter determines the object value after the bus voltage returns. It is visible only if "data point type value range = DPT 7.600 1000 ... 10000 K".	
Value	-32768 ... 0 ... 32767
This parameter determines the object value after the bus voltage returns. It is visible only if "data point type value range = DPT 8.001 -32768 ... 32767".	
Temperature value	0 ... 20 ... 40°C
This parameter determines the object value after the bus voltage returns. It is visible only if "data point type value range = DPT 9.001 0 ... 40°C".	
Brightness value	0, 50 ... 300 ... 1500 lux
This parameter determines the object value after the bus voltage returns. It is visible only if "data point type value range = DPT 9.004 0 ... 1500 lux".	
Colour temperature value	1000 ... 2700 ... 10000 K
This parameter determines the object value after the bus voltage returns. It is visible only if "data point type value range = DPT 249.600 colour temperature value + brightness".	
Brightness value	0 ... 100%
This parameter determines the object value after the bus voltage returns. It is visible only if "data point type value range = DPT 249.600 colour temperature value + brightness".	
Adjustment duration in the actuator	0 ... 100 min, 0, 1 ... 59 s, 0 ... 900 ms
This parameter determines the object value after the bus voltage returns. It is visible only if "data point type value range = DPT 249.600 colour temperature value + brightness".	
Colour value	#000000 ... #FFFFFF
This parameter determines the object values of the 3-byte value transmitter (or 6-byte value transmitter), brightness value (V), saturation (S) and colour hue (H) objects after the bus voltage returns. It is visible with "data point type value range = RGB/HSV with colour wheel sequence (RGB: DPT 232.600, HSV: DPT 5.003, DPT 5.001, DPT 5.001)", "data point type value range = RGB/HSV with brightness adjustment (RGB: DPT 232.600, HSV: DPT 5.003, DPT 5.001, DPT 5.001)" and "data point type value range = colour value RGBW/HSVW (RGBW: DPT 251.600, HSVW: DPT 5.003, DPT 5.001, DPT 5.001, DPT 5.001)". The value (RGB/HSV) is configured by means of a colour picker. With the data point type value range "colour value RGBW/HSVW (RGBW: DPT 251.600, HSVW: DPT 5.003, DPT 5.001, DPT 5.001, DPT 5.001)", the white value is configured by means of a separate slider.	

White value	0 ... 255
<p>This parameter determines the object value of the white value (W) after the bus voltage returns.</p> <p>It is visible only if "data point type value range = colour value RGBW/HSVW (RGBW: DPT 251.600, HSVW: DPT 5.003, DPT 5.001, DPT 5.001, DPT 5.001)".</p>	
Disabling function	Inactive Active
<p>This parameter enables the disabling function for the channel.</p>	
At the beginning of the disabling function	no reaction Transmit value
<p>Besides disabling the channel, the device can immediately react when the disabling occurs.</p> <p>This parameter defines the reaction of the channel at the beginning of the disabling.</p>	
Value	0 ... 100%
<p>This parameter determines the object value at the beginning of the disabling.</p> <p>It is visible only if "data point type value range = DPT 5.001 0 ... 100%".</p>	
Value	0 ... 255
<p>This parameter determines the object value at the beginning of the disabling.</p> <p>It is visible only if "data point type value range = DPT 5.010 0 ... 255".</p>	
Value	0 ... 360°
<p>This parameter determines the object value at the beginning of the disabling.</p> <p>It is visible only if "data point type value range = DPT 5.003 0 ... 360°".</p>	
Value	0 ... 255%
<p>This parameter determines the object value at the beginning of the disabling.</p> <p>It is visible only if "data point type value range = DPT 5.004 0 ... 255%".</p>	
Value	-128...0 ... 127
<p>This parameter determines the object value at the beginning of the disabling.</p> <p>It is visible only if "data point type value range = DPT 6.010 -128 ... 127".</p>	
Value	0 ... 65535
<p>This parameter determines the object value at the beginning of the disabling.</p> <p>It is visible only if "data point type value range = DPT 7.001 0 ... 65535".</p>	
Colour temperature value	1000 ... 2700 ... 10000 K
<p>This parameter determines the object value at the beginning of the disabling.</p> <p>It is visible only if "data point type value range = DPT 7.600 1000 ... 10000 K".</p>	

Value	-32768 ... 0 ... 32767
This parameter determines the object value at the beginning of the disabling. It is visible only if "data point type value range = DPT 8.001 -32768 ... 32767".	
Temperature value	0 ... 20 ... 40°C
This parameter determines the object value at the beginning of the disabling. It is visible only if "data point type value range = DPT 9.001 0 ... 40°C".	
Brightness value	0, 50 ... 300 ... 1500 lux
This parameter determines the object value at the beginning of the disabling. It is visible only if "data point type value range = DPT 9.004 0 ... 1500 lux".	
Colour temperature value	1000 ... 2700 ... 10000 K
This parameter determines the object value at the beginning of the disabling. It is visible only if "data point type value range = DPT 249.600 colour temperature value + brightness".	
Brightness value	0 ... 100%
This parameter determines the object value at the beginning of the disabling. It is visible only if "data point type value range = DPT 249.600 colour temperature value + brightness".	
Adjustment duration in the actuator	0 ... 100 min, 0, 1 ... 59 s, 0 ... 900 ms
This parameter determines the object value at the beginning of the disabling. It is visible only if "data point type value range = DPT 249.600 colour temperature value + brightness".	
Colour value	#000000 ... #FFFFFF
This parameter determines the object values of the 3-byte value transmitter (or 6-byte value transmitter), brightness value (V), saturation (S) and colour hue (H) objects at the beginning of the disabling. It is visible with "data point type value range = RGB/HSV with colour wheel sequence (RGB: DPT 232.600, HSV: DPT 5.003, DPT 5.001, DPT 5.001)", "data point type value range = RGB/HSV with brightness adjustment (RGB: DPT 232.600, HSV: DPT 5.003, DPT 5.001, DPT 5.001)" and "data point type value range = colour value RGBW/HSVW (RGBW: DPT 251.600, HSVW: DPT 5.003, DPT 5.001, DPT 5.001, DPT 5.001)". The value (RGB/HSV) is configured by means of a colour picker. With the data point type value range "colour value RGBW/HSVW (RGBW: DPT 251.600, HSVW: DPT 5.003, DPT 5.001, DPT 5.001, DPT 5.001)", the white value is configured by means of a separate slider.	

White value	0 ... 255
<p>This parameter determines the object value of the white value (W) object at the beginning of the disabling.</p> <p>It is visible only if "data point type value range = colour value RGBW/HSVW (RGBW: DPT 251.600, HSVW: DPT 5.003, DPT 5.001, DPT 5.001, DPT 5.001)".</p>	
At the end of the disabling function	no reaction Transmit current state Transmit value
<p>Besides disabling the channel, the device can immediately react at the end of the disabling.</p> <p>This parameter defines the reaction of the channel at the end of the disabling.</p>	
Value	0 ... 100%
<p>This parameter determines the object value at the end of the disabling.</p> <p>It is visible only if "data point type value range = DPT 5.001 0 ... 100%".</p>	
Value	0 ... 255
<p>This parameter determines the object value at the end of the disabling.</p> <p>It is visible only if "data point type value range = DPT 5.010 0 ... 255".</p>	
Value	0 ... 360°
<p>This parameter determines the object value at the end of the disabling.</p> <p>It is visible only if "data point type value range = DPT 5.003 0 ... 360°".</p>	
Value	0 ... 255%
<p>This parameter determines the object value at the end of the disabling.</p> <p>It is visible only if "data point type value range = DPT 5.004 0 ... 255%".</p>	
Value	-128...0 ...127
<p>This parameter determines the object value at the end of the disabling.</p> <p>It is visible only if "data point type value range = DPT 6.010 -128 ... 127".</p>	
Value	0 ... 65535
<p>This parameter determines the object value at the end of the disabling.</p> <p>It is visible only if "data point type value range = DPT 7.001 0 ... 65535".</p>	
Colour temperature value	1000 ... 2700 ... 10000 K
<p>This parameter determines the object value at the end of the disabling.</p> <p>It is visible only if "data point type value range = DPT 7.600 1000 ... 10000 K".</p>	

Value	-32768 ... 0 ... 32767
This parameter determines the object value at the end of the disabling. It is visible only if "data point type value range = DPT 8.001 -32768 ... 32767".	
Temperature value	0 ... 20 ... 40°C
This parameter determines the object value at the end of the disabling. It is visible only if "data point type value range = DPT 9.001 0 ... 40°C".	
Brightness value	0, 50 ... 300 ... 1500 lux
This parameter determines the object value at the end of the disabling. It is visible only if "data point type value range = DPT 9.004 0 ... 1500 lux".	
Colour temperature value	1000 ... 2700 ... 10000 K
This parameter determines the object value at the end of the disabling. It is visible only if "data point type value range = DPT 249.600 colour temperature value + brightness".	
Brightness value	0 ... 100%
This parameter determines the object value at the end of the disabling. It is visible only if "data point type value range = DPT 249.600 colour temperature value + brightness".	
Adjustment duration in the actuator	0 ... 100 min, 0, 1 ... 59 s, 0 ... 900 ms
This parameter determines the object value at the end of the disabling. It is visible only if "data point type value range = DPT 249.600 colour temperature value + brightness".	
Colour value	#000000 ... #FFFFFF
This parameter determines the object values of the 3-byte value transmitter (or 6-byte value transmitter), brightness value (V), saturation (S) and colour hue (H) objects at the end of the disabling. It is visible with "data point type value range = RGB/HSV with colour wheel sequence (RGB: DPT 232.600, HSV: DPT 5.003, DPT 5.001, DPT 5.001)", "data point type value range = RGB/HSV with brightness adjustment (RGB: DPT 232.600, HSV: DPT 5.003, DPT 5.001, DPT 5.001)" and "data point type value range = colour value RGBW/HSVW (RGBW: DPT 251.600, HSVW: DPT 5.003, DPT 5.001, DPT 5.001, DPT 5.001)". The value (RGB/HSV) is configured by means of a colour picker. With the data point type value range "colour value RGBW/HSVW (RGBW: DPT 251.600, HSVW: DPT 5.003, DPT 5.001, DPT 5.001, DPT 5.001)", the white value is configured by means of a separate slider.	

White value	0 ... 255
<p>This parameter determines the object value of the white value (W) object at the end of the disabling.</p> <p>It is visible only if "data point type value range = colour value RGBW/HSVW (RGBW: DPT 251.600, HSVW: DPT 5.003, DPT 5.001, DPT 5.001, DPT 5.001)".</p>	
Object polarity	0 = enabled / 1 = disable 1 = enabled / 0 = disable
<p>This parameter defines the value of the disabling object at which the disabling function is active.</p>	

8.1.6.2 Object list

The following communication objects are available in the "push-button" channel function with the parameterised "value transmitter" function. The name can be adjusted with the "Name" parameter.

Object no.	Function	Name	Type	DPT	Flag
397, 421, ..., 469	Value transmitter - 0...100%	K <i>n</i> - Output	1-byte	5,001	C, R, -, T, A
1-byte object for the transmission of values from 0 to 100%.					
i These objects are visible only if "data point type value range = DPT 5.001 0 ... 100%".					

Object no.	Function	Name	Type	DPT	Flag
397, 421, ..., 469	Value transmitter - 0...255	K <i>n</i> - Output	1-byte	5,010	C, R, -, T, A
1-byte object for the transmission of values from 0 to 255.					
i These objects are visible only if "data point type value range = DPT 5.010 0 ... 255".					

Object no.	Function	Name	Type	DPT	Flag
397, 421, ..., 469	Value transmitter - 0...360°	K <i>n</i> - Output	1-byte	5,003	C, R, -, T, A
1-byte object for the transmission of values from 0 to 360°.					
i These objects are visible only if "data point type value range = DPT 5.003 0 ... 360°".					

Object no.	Function	Name	Type	DPT	Flag
397, 421, ..., 469	Value transmitter - 0...255%	K <i>n</i> - Output	1-byte	5,004	C, R, -, T, A
1-byte object for the transmission of values from 0 to 255%.					
i These objects are visible only if "data point type value range = DPT 5.004 0 ... 255%".					

Object no.	Function	Name	Type	DPT	Flag
397, 421, ..., 469	Value transmitter - -128...127	K <i>n</i> - Output	1-byte	6,010	C, R, -, T, A
1-byte object for the transmission of values from -128 to 127.					
i These objects are visible only if "data point type value range = DPT 6.010 -128 ... 127".					

Object no.	Function	Name	Type	DPT	Flag
397, 421, ..., 469	Value transmitter - 0...65535	K n - Output	2-byte	7,001	C, R, -, T, A

2-byte object for the transmission of values from 0 to 65535.

i These objects are visible only if "data point type | value range = DPT 7.001 | 0 ... 65535".

Object no.	Function	Name	Type	DPT	Flag
397, 421, ..., 469	Value transmitter - Colour temperature value	K n - Output	2-byte	7,600	C, R, -, T, A

2-byte object for transmitting colour temperatures from 1000 to 10000 Kelvin.

i These objects are visible only if "data point type | value range = DPT 7.600 | 1000 ... 10000 K".

Object no.	Function	Name	Type	DPT	Flag
397, 421, ..., 469	Value transmitter - -32768...32767	K n - Output	2-byte	8,001	C, R, -, T, A

2-byte object for the transmission of values from -32768 to 32767.

i These objects are visible only if "data point type | value range = DPT 8.001 | -32768 ... 32767".

Object no.	Function	Name	Type	DPT	Flag
397, 421, ..., 469	Value transmitter - Temperature value	K n - Output	2-byte	9,001	C, R, -, T, A

2-byte object for transmitting temperature values from 0 to 40 °C.

i These objects are visible only if "data point type | value range = DPT 9.001 | 0 ... 40°C".

Object no.	Function	Name	Type	DPT	Flag
397, 421, ..., 469	Value transmitter - Brightness value	K n - Output	2-byte	9,004	C, R, -, T, A

2-byte object for transmitting brightness values from 0 to 1500 Lux.

i These objects are visible only if "data point type | value range = DPT 9.004 | 0 ... 1500 lux".

Object no.	Function	Name	Type	DPT	Flag
397, 421, ..., 469	Value transmitter - Colour temperature value and brightness value	K n - Output	6-byte	249,600	C, R, -, T, A
<p>6-byte object used to transmit a colour temperature value, a brightness value and the adjustment time in the actuator. The actuator sets the received values during the adjustment time.</p> <p>i These objects are visible only if "data point type value range = DPT 249.600 colour temperature value + brightness" applies.</p>					
Object no.	Function	Name	Type	DPT	Flag
397, 421, ..., 469	Value transmitter - RGB/HSV (colour wheel sequence)	K n - Output	3-byte	232,600	C, R, -, T, A
<p>3-byte object for transmitting 3-byte colour information.</p> <p>i These objects are visible only if "data point type value range = RGB/HSV with colour wheel sequence (RGB: DPT 232.600, HSV: DPT 5.003, DPT 5.001, DPT 5.001)".</p>					
Object no.	Function	Name	Type	DPT	Flag
397, 421, ..., 469	Value transmitter - RGB/HSV (brightness adjustment)	K n - Output	3-byte	232,600	C, R, -, T, A
<p>3-byte object for transmitting 3-byte colour information.</p> <p>i These objects are visible only with data point type value range: RGB/HSV with brightness adjustment (RGB: DPT 232.600, HSV: DPT 5.003, DPT 5.001, DPT 5.001).</p>					
Object no.	Function	Name	Type	DPT	Flag
397, 421, ..., 469	Value transmitter - RGBW	K n - Output	6-byte	251,600	C, R, -, T, A
<p>6-byte object for transmitting 6-byte colour information.</p> <p>i These objects are visible only with data point type value range: colour value RGBW/HSVW (RGBW: DPT 251.600, HSVW: DPT 5.003, DPT 5.001, DPT 5.001, DPT 5.001).</p>					

Object no.	Function	Name	Type	DPT	Flag
398, 422, ..., 470	Value transmitter - Colour hue (H)	K n - Output	1-byte	5,003	C, R, -, T, A

1-byte object for transmitting the colour hue.

- i** These objects are visible only with data point type | value range:
- RGB/HSV with colour wheel sequence (RGB: DPT 232.600, HSV: DPT 5.003, DPT 5.001, DPT 5.001)
 - RGB/HSV with brightness adjustment (RGB: DPT 232.600, HSV: DPT 5.003, DPT 5.001, DPT 5.001)
 - Colour value RGBW/HSVW (RGBW: DPT 251.600, HSVW: DPT 5.003, DPT 5.001, DPT 5.001, DPT 5.001)

Object no.	Function	Name	Type	DPT	Flag
399, 423, ..., 471	Value transmitter - Saturation (S)	K n - Output	1-byte	5,001	C, R, -, T, A

1-byte object for transmitting the saturation.

- i** These objects are visible only with data point type | value range:
- RGB/HSV with colour wheel sequence (RGB: DPT 232.600, HSV: DPT 5.003, DPT 5.001, DPT 5.001)
 - RGB/HSV with brightness adjustment (RGB: DPT 232.600, HSV: DPT 5.003, DPT 5.001, DPT 5.001)
 - Colour value RGBW/HSVW (RGBW: DPT 251.600, HSVW: DPT 5.003, DPT 5.001, DPT 5.001, DPT 5.001)

Object no.	Function	Name	Type	DPT	Flag
400, 424, ..., 472	Value transmitter - brightness value (V)	K n - Output	1-byte	5,001	C, R, -, T, A

1-byte object for transmitting the brightness value.

- i** These objects are visible only with data point type | value range:
- RGB/HSV with colour wheel sequence (RGB: DPT 232.600, HSV: DPT 5.003, DPT 5.001, DPT 5.001)
 - RGB/HSV with brightness adjustment (RGB: DPT 232.600, HSV: DPT 5.003, DPT 5.001, DPT 5.001)
 - Colour value RGBW/HSVW (RGBW: DPT 251.600, HSVW: DPT 5.003, DPT 5.001, DPT 5.001, DPT 5.001)

Object no.	Function	Name	Type	DPT	Flag
401, 425, ..., 473	Value transmitter - White value (W)	K n - Output	1-byte	5,001	C, R, -, T, A
<p>1-byte object for transmitting the white level.</p> <p>i These objects are visible only with data point type value range: colour value RGBW/HSVW (RGBW: DPT 251.600, HSVW: DPT 5.003, DPT 5.001, DPT 5.001, DPT 5.001).</p>					
403, 427, ..., 475	Value transmitter - Brightness value (V) - Status	K n - Input	1-byte	5,001	C, -, W, -, U
<p>1-byte object for receiving the brightness value.</p> <p>i These objects are only visible with the following configuration:</p> <ul style="list-style-type: none"> - Data point type value range: RGB/HSV with brightness adjustment (RGB: DPT 232.600, HSV: DPT 5.003, DPT 5.001, DPT 5.001) - "Start value" parameter = as value from brightness (V) status object 					
403, 427, ..., 475	Value transmitter - Colour hue (H) - Status	K n - Input	1-byte	5,003	C, -, W, -, U
<p>1-byte object for receiving the colour hue.</p> <p>i These objects are only visible with the following configuration:</p> <ul style="list-style-type: none"> - Data point type value range: RGB/HSV with colour wheel sequence (RGB: DPT 232.600, HSV: DPT 5.003, DPT 5.001, DPT 5.001) - "Start value" parameter = as value from colour hue (H) status object 					
403, 427, ..., 475	Value transmitter - RGB - Status	K n - Input	3-byte	232,600	C, -, W, -, U
<p>3-byte object for receiving 3-byte colour information.</p> <p>i These objects are only visible with the following configuration:</p> <ul style="list-style-type: none"> - Parameter: data point type value range: RGB/HSV with brightness adjustment (RGB: DPT 232.600, HSV: DPT 5.003, DPT 5.001, DPT 5.001), RGB/HSV with colour wheel sequence (RGB: DPT 232.600, HSV: DPT 5.003, DPT 5.001, DPT 5.001). - "Start value" parameter = as value from RGB status object 					

Object no.	Function	Name	Type	DPT	Flag
408, 432, ..., 480	Value transmitter - Disabling	K <i>n</i> - Input	1-bit	1,003	C, -, W, -, U
1-bit object for activating or deactivating the disabling function. The object polarity can be parameterised.					

8.1.7 Scene extension

In the "push-button" channel function, the push-button can be parameterised for the "scene extension" function. The ETS indicates up to two communication objects for the "scene extension" function. The parameters can be used to determine the value the "scene extension" object obtains when the button is pressed. Furthermore, the behaviour of the channel after the bus voltage returns can be parameterised and a disabling function activated.

In the scene extension function, the device calls either a parameterised scene number (1...64) or switches between two scenes if the button is briefly pressed. This makes it possible to recall scenes stored in other devices. Optionally, the channel performs a storage function if the button is pressed for a long time.

Setting options when button is pressed briefly:

- Recall scene: results in simply recalling the scene.
- Switch over scene: The input option for a second scene number (1...64) appears. The two entered scene numbers are switched to and from each time the button is briefly pressed.

Setting options when button is pressed and held:

- No reaction
- Storage function: A storage command is generated by actuating the button for more than five seconds. In the scene extension function, a storage telegram is in this case transmitted to the bus. The internal scene is stored. The internal scene control module will then request the current scene values for the actuator groups used from the bus.

i A button actuation lasting between one and five seconds will be discarded as invalid.

8.1.7.1 Table of parameters

The following parameters are available in the "push-button" channel function with the parameterised "scene extension" function.

Short button actuation	Recall scene Switch over scene
<p>This parameter defines the functionality of the scene extension.</p> <p>If the device is used as a scene extension, the scenes can either be stored in one or several other KNX devices (e.g. light scene push button sensor). When a scene is recalled, the device transmits a telegram with the respective scene number via the extension object of the button.</p>	
Scene number	1...64
<p>In accordance with the KNX standard, objects with data type 18.001 "Scene Control" can retrieve or store up to 64 scenes by their numbers. The parameter defines the scene number to be transmitted when the button is pressed.</p> <p>The input of the scene number is available only if "Call scene" is active in the event of the "short button actuation" command.</p>	
First scene number	1...64
<p>In accordance with the KNX standard, objects with data type 18.001 "Scene Control" can retrieve or store up to 64 scenes by their numbers. The parameter defines the scene number to be transmitted when the button is pressed.</p> <p>The input of the first scene number is available only if "Switch over scene" is active in the event of the "short button actuation" command.</p>	
Second scene number	1, 2 ... 64
<p>In accordance with the KNX standard, objects with data type 18.001 "Scene Control" can retrieve or store up to 64 scenes by their numbers. The parameter defines the scene number to be transmitted when the button is pressed.</p> <p>The input of the second scene number is available only if "Switch over scene" is active in the event of the "short button actuation" command.</p>	
Long button actuation	No reaction Memory function
<p>This parameter defines the functionality of the scene extension.</p> <p>If the device is used as a scene extension, the scenes can either be stored in one or several other KNX devices (e.g. light scene push button sensor). With activated storage function, the device transmits a telegram with the respective scene number via the extension object of the button.</p>	

After bus voltage return	no reaction Transmit current state Recall scene
<p>This parameter determines the reaction after the bus voltage returns.</p> <p>Either no telegram, a telegram according to the current input state at the channel or a parameterised scene number is transmitted on the bus according to the parameterisation.</p> <p>The reaction after the bus voltage returns takes place only after the parameterised "delay after bus voltage returns" expires ("General" parameter page).</p>	
Scene number	1...64
The parameter defines here the scene number to be transmitted after the bus voltage returns.	
Disabling function	Inactive Active
This parameter enables the disabling function for the channel.	
At the beginning of the disabling function	no reaction Recall scene
<p>Besides disabling the channel, the device can immediately react when the disabling occurs.</p> <p>This parameter defines the reaction of the channel at the beginning of the disabling.</p>	
Scene number	1...64
The scene number to be transmitted at the beginning of the disabling is defined here.	
At the end of the disabling function	no reaction Transmit current state Recall scene
<p>Besides disabling the channel, the device can immediately react at the end of the disabling.</p> <p>This parameter defines the reaction of the channel at the end of the disabling.</p>	
Scene number	1...64
The scene number to be transmitted at the end of the disabling is defined here.	
Object polarity	0 = enabled / 1 = disable 1 = enabled / 0 = disable
This parameter defines the value of the disabling object at which the disabling function is active.	

8.1.7.2 Object list

The following communication objects are available in the "push-button" channel function with the parameterised "scene extension" function. The name can be adjusted with the "Name" parameter.

Object no.	Function	Name	Type	DPT	Flag
590, 598, ..., 614	Scene extension - Scene number	K n - Output	1-byte	18,001	C, R, -, T, A
1-byte object for recalling, switching over or storing one of a maximum of 64 scenes at a scene push-button sensor.					

Object no.	Function	Name	Type	DPT	Flag
591, 599, ..., 615	Scene extension - Disabling	K n - Input	1-bit	1,003	C, -, W, -, U
1-bit object for activating or deactivating the disabling function. The object polarity can be parameterised.					

8.1.8 Short and long button actuation

i The "short and long button actuation" function replaces the "2-channel operation" function.

In the "push-button" channel function, the push-button can be parameterised for the "short and long button actuation" function. The ETS indicates up to nine communication objects for each channel for the "short and long button actuation" function. The parameters can be used to determine the values the "short and long button actuation" objects obtain when the button is pressed. Furthermore, the behaviour of the channel after the bus voltage returns can be parameterised and a disabling function activated.

The "short and long button actuation" function allows two objects to be operated with one push-button. Two different functions can be configured to transmit different telegrams.

The following functions are available:

- DPT 1.001 | Switching
- DPT 2.001 | Forced position
- DPT 5.001 | 0 ... 100%
- DPT 5.010 | 0 ... 255
- DPT 5.003 | 0 ... 360°
- DPT 5.004 | 0 ... 255%
- DPT 6.010 | -128 ... 127
- DPT 7.001 | 0 ... 65535
- DPT 8.001 | -32768 ... 32767

- DPT 9.001 | 0 ... 40°C
- DPT 9.004 | 0 ... 1500 lux
- DPT 18.001 | Call up scene (externally)
- DPT 18.001 | Switch scene (external)
- Room temperature control point
- RGB/HSV (RGB: DPT 232.600, HSV: DPT 5.003, DPT 5.001, DPT 5.001)
- RGBW/HSVW (RGBW: DPT 251.600, HSVW: DPT 5.003, DPT 5.001, DPT 5.001, DPT 5.001)

The object value that the device is to transmit on a button actuation can be selected depending on the selected function.

Transmission behaviour, long button actuation = object 2

With this transmission behaviour, exactly one telegram is sent each time the button is pressed.

- The device sends the telegram for object 1 if the button is pressed briefly.
- The device sends the telegram for object 2 if the button is pressed longer.

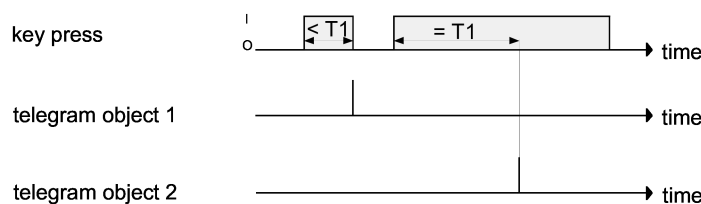

$T1$ = time between object 1 and object 2

Figure 12: Example of "object 1 or object 2" operating concept

The "Long button actuation from" parameter defines the time period for distinguishing between short-time and long-time operation. If the push-button is pressed for shorter than the parameterised time, only the telegram for object 1 is transmitted on the bus. If the "long button actuation" time is exceeded by the actuation period, only the telegram for object 2 is transmitted on the bus.

i The device does not directly transmit a telegram on the bus.

Transmission behaviour, long button actuation = object 1 and object 2

With this transmission behaviour, one or alternatively two telegrams can be transmitted each time the button is pressed.

- The device will send the telegram for object 1 if the button is pressed briefly.
- The device will send the telegram for object 1 and then the telegram for object 2 if the button is pressed longer.

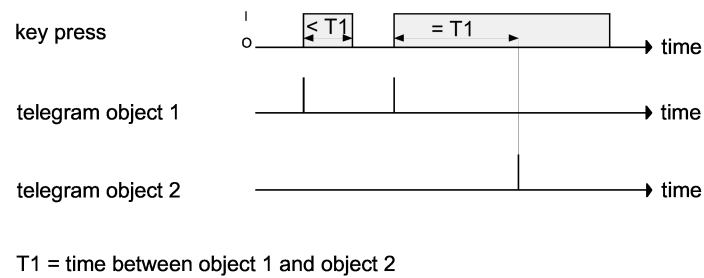

Figure 13: Example of "object 1 and object 2" operating concept

The "Long button actuation from" parameter defines the time period for distinguishing between short-time and long-time operation. The telegram for object 1 is immediately transmitted on the bus if the button is pressed. If the push-button remains pressed for the parameterised time, the telegram for object 2 is also transmitted on the bus. If the push-button is released before the time expires, no further telegram is transmitted on the bus.

- i** The "long button actuation from" time is to be parameterised for a sufficient period, depending on the application case, to prevent simultaneous transmission of the objects.

8.1.8.1 Table of parameters

The following parameters are available in the "push-button" channel function with the parameterised "short and long button actuation" function.

Short button actuation (object 1)	No function DPT 1.001 Switching DPT 2.001 Forced position DPT 5.001 0 ... 100% DPT 5.010 0 ... 255 DPT 5.003 0 ... 360° DPT 5.004 0 ... 255% DPT 6.010 -128 ... 127 DPT 7.001 0 ... 65535 DPT 7.006 1000 ... 10000 K DPT 8.001 -32768 ... 32767 DPT 9.001 0 ... 40°C DPT 9.004 0 ... 1500 lux DPT 18.001 Call up scene (externally) DPT 18.001 Switch scene (external) DPT 249.600 Colour temperature value + brightness Room temperature control point RGB/HSV (RGB: DPT 232.600, HSV: DPT 5.003, DPT 5.001, DPT 5.001) RGBW/HSVW (RGBW: DPT 251.600, HSVW: DPT 5.003, DPT 5.001, DPT 5.001, DPT 5.001)
-----------------------------------	---

This parameter determines the function of the short button actuation and defines the other parameters and communication objects to be displayed.

Function	Operating mode switchover Forced oper. mode switchover Presence function Target temperature shift
----------	---

A room temperature control point can optionally switch over (force) the operating mode with normal or high priority, change the presence status or change the current room temperature setpoint value.

Visible only if "short button actuation (object 1) = room temperature control point".

Target temperature shift	By relative temperature value By meter value
Depending on the setting of the "Target temperature shift" parameter, the shift takes place by means of the 2-byte communication object in accordance with KNX DPT 9.002 or KNX DPT 6.010. Visible only if "functionality = setpoint temperature shift".	
Long button actuation (object 2)	No function DPT 1.001 Switching DPT 2.001 Forced position DPT 5.001 0 ... 100% DPT 5.010 0 ... 255 DPT 5.003 0 ... 360° DPT 5.004 0 ... 255% DPT 6.010 -128 ... 127 DPT 7.001 0 ... 65535 DPT 7.006 1000 ... 10000 K DPT 8.001 -32768 ... 32767 DPT 9.001 0 ... 40°C DPT 9.004 0 ... 1500 lux DPT 18.001 Call up scene (externally) DPT 18.001 Switch scene (external) DPT 249.600 Colour temperature value + brightness Room temperature control point RGB/HSV (RGB: DPT 232.600, HSV: DPT 5.003, DPT 5.001, DPT 5.001) RGBW/HSVW (RGBW: DPT 251.600, HSVW: DPT 5.003, DPT 5.001, DPT 5.001, DPT 5.001)
This parameter determines the function of the long button actuation and defines the other parameters and communication objects to be displayed.	
Function	Operating mode switchover Forced oper. mode switchover Presence function Target temperature shift
A room temperature control point can optionally switch over (force) the operating mode with normal or high priority, change the presence status or change the current room temperature setpoint value. Visible only if "long button actuation (object 2) = room temperature control point".	

Target temperature shift	By relative temperature value By meter value
Depending on the setting of the "Target temperature shift" parameter, the shift takes place by means of the 2-byte communication object in accordance with KNX DPT 9.002 or KNX DPT 6.010. Visible only if "functionality = setpoint temperature shift".	
Short button actuation (object 1) Long button actuation (object 2)	ON OFF TOGGLE
This parameter defines the object value transmitted to the bus when the button is pressed. It is visible only if "function = DPT 1.001 switching".	
Short button actuation (object 1) Long button actuation (object 2)	no reaction Forcing active, ON Forcing active, OFF Forcing inactive
This parameter defines the object value transmitted to the bus when the button is pressed. It is visible only if "functionality = DPT 2.001 forced position".	
Short button actuation (object 1) Long button actuation (object 2) Value	0...100 %
This parameter defines the object value transmitted to the bus when the button is pressed. It is visible only if "function = DPT 5.001 0 ... 100%".	
Short button actuation (object 1) Long button actuation (object 2) Value	0...255
This parameter defines the object value transmitted to the bus when the button is pressed. It is visible only if "function = DPT 5.010 0 ... 255".	
Short button actuation (object 1) Long button actuation (object 2) Value	0...360°
This parameter defines the object value transmitted to the bus when the button is pressed. It is visible only if "function = DPT 5.003 0 ... 360°".	

Short button actuation (object 1) Long button actuation (object 2) Value	0...255 %
This parameter defines the object value transmitted to the bus when the button is pressed. It is visible only if "function = DPT 5.004 0 ... 255%".	
Short button actuation (object 1) Long button actuation (object 2) Value	-128...0...127
This parameter defines the object value transmitted to the bus when the button is pressed. It is visible only if "function = DPT 6.010 -128 ... 127".	
Short button actuation (object 1) Long button actuation (object 2) Value	0...65535
This parameter defines the object value transmitted to the bus when the button is pressed. It is visible only if "function = DPT 7.001 0 ... 65535".	
Short button actuation (object 1) Long button actuation (object 2) Value	1000...2700...10000 K
This parameter defines the object value transmitted to the bus when the button is pressed. It is visible only if "functionality = DPT 7.600 1000 ... 10000 K".	
Short button actuation (object 1) Long button actuation (object 2) Value	-32768...0...32767
This parameter defines the object value transmitted to the bus when the button is pressed. It is visible only if "function = DPT 8.001 -32768 ... 32767".	
Short button actuation (object 1) Long button actuation (object 2) Temperature value	0...20...40°C
This parameter defines the object value transmitted to the bus when the button is pressed. It is visible only if "function = DPT 9.001 0 ... 40°C".	

Short button actuation (object 1) Long button actuation (object 2) Brightness value	0... 300 ...1500 lux
This parameter defines the object value transmitted to the bus when the button is pressed. It is visible only if "function of object 1 (2) = DPT 9.004 0 ... 1500 lux".	
Short button actuation (object 1) Long button actuation (object 2) Scene number	1 ...64
This parameter defines the object value transmitted to the bus when the button is pressed. It is visible only if "function = DPT 18.001 Recall scene (externally)".	
Short button actuation (object 1) Long button actuation (object 2) First scene number	1 ...64
This parameter defines the object value transmitted to the bus when the button is pressed. It is visible only if "functionality = DPT 18.001 Switch over scene (externally)".	
Short button actuation (object 1) Long button actuation (object 2) Second scene number	1 ... 2 ...64
This parameter defines the object value transmitted to the bus when the button is pressed. It is visible only if "functionality = DPT 18.001 Switch over scene (externally)".	
Short button actuation (object 1) Long button actuation (object 2) Colour temperature value	1000 ... 2700 ... 10000 K
This parameter defines the object value when the button is pressed. It is visible only if "functionality = DPT 249.600 colour temperature value + brightness".	
Short button actuation (object 1) Long button actuation (object 2) Brightness value	0 ... 100 %
This parameter defines the object value when the button is pressed. It is visible only if "functionality = DPT 249.600 colour temperature value + brightness".	

Short button actuation (object 1) Long button actuation (object 2) Adjustment duration in the actuator	0 ... 100 min, 0, 1 ... 59 s, 0 ... 900 ms
This parameter defines the object value when the button is pressed. It is visible only if "functionality = DPT 249.600 colour temperature value + brightness".	
Short button actuation (object 1) Long button actuation (object 2) Operating mode	Comfort Standby Night Frost/heat protection Switchover: comfort/standby Switchover: comfort/night Switchover: standby/night Switchover: comfort/standby/night
If the room temperature control point is intended to change over the operating mode of the room temperature controller with normal priority, the extension can either switch on a defined operating mode or switch between different operating modes when operated. Visible only if "functionality = room temperature control point -> operating mode change-over".	
Short button actuation (object 1) Long button actuation (object 2) Forced operating mode	Forcing inactive (auto) Comfort Standby Night Frost/heat protection Switchover: comfort/standby Switchover: comfort/night Switchover: standby/night Switchover: comfort/standby/night Toggle: forced inactive (auto) / comfort Toggle: forced inactive (auto) / standby Toggle: forced inactive (auto) / night Switchover: forced inactive (auto) / frost/heat protection
If the room temperature control point is intended to switch the operating mode of the room temperature controller with high priority, the extension can either enable change-over with normal priority (auto), switch on a defined operating mode with high priority or switch different operating modes when operated. Visible only if "functionality = room temperature control point -> forced operating mode change-over".	

Short button actuation (object 1) Long button actuation (object 2)	Presence ON Presence OFF Presence TOGGLE
<p>The room temperature control point can switch the presence state of the room temperature controller either on or off in a defined way or the extension can switch between both states ("Presence TOGGLE") by pressing the button.</p> <p>Visible only if "functionality = room temperature control point -> presence function".</p>	

Short button actuation (object 1) Long button actuation (object 2) Target temperature shift	+2 K +1.5 K +1 K +0.5 K -0.5 K -1 K -1.5 K -2 K
---	---

The temperature difference is defined in Kelvin here by which the setpoint temperature will be shifted up or down when the button is pressed.

To shift the setpoint temperature, the room temperature control point uses the two communication objects "Setpoint temperature shift" and "Setpoint temperature shift - Status".

The communication object "Setpoint temperature shift - Status" informs the room temperature control point about the current state of the room temperature controller. Based on this value and the parameter here, the room temperature control point calculates the new level value, which it transmits to the room temperature controller by means of the "setpoint temperature shift" communication object.

Visible only if "Functionality = room temperature control point -> Setpoint temperature shift -> By relative temperature value".

Short button actuation (object 1) Long button actuation (object 2)	Increase setpoint temperature Reduce setpoint temperature
---	---

The direction of the target temperature shift is defined here at the room temperature control point.

To shift the setpoint temperature, the room temperature control point uses the two communication objects "Setpoint temperature shift" and "Setpoint temperature shift - Status".

The communication object "Setpoint temperature shift - Status" informs the extension about the current state of the room temperature controller. Based on this value and the parameter here, the room temperature control point calculates the new level value, which it transmits to the room temperature controller by means of the "setpoint temperature shift" communication object.

Visible only if "Functionality = room temperature control point -> Setpoint temperature shift -> By counting value".

Short button actuation (object 1) Long button actuation (object 2) Colour value	#000000 ... #FFFFFF
<p>This parameter determines the object values of the colour hue (H), saturation (S), brightness value (V), which is transmitted to the bus when the button is pressed. It is visible if "function = RGB/HSV (RGB: DPT 232.600, HSV: DPT 5.003, DPT 5.001, DPT 5.001)".</p>	
Short button actuation (object 1) Long button actuation (object 2) White value	0 ... 255
<p>This parameter defines the object value of the white level (W) object when the button is pressed. It is visible only if "function = RGBW/HSVW (RGBW: DPT 251.600, HSVW: DPT 5.003, DPT 5.001, DPT 5.001, DPT 5.001)".</p>	
Advanced parameters	Active Inactive
<p>This parameter enables advanced configuration options for the "short and long button actuation" function.</p> <p>If the advanced parameters are deactivated, the device transmits object 1 if the button is pressed briefly and object 2 if it is pressed for a long period. Pressing the button for at least 3 seconds is regarded as long.</p> <p>When the advanced parameters are activated, the ETS shows the following parameters.</p>	
Transmission behaviour, long button actuation	Object 2 Object 1 and object 2
<p>This parameter defines the transmission behaviour of long button actuation.</p> <p>Object 2: object 1 is transmitted by pressing the button briefly and object 2 is transmitted by pressing the button for a long period</p> <p>Object 1 and object 2: object 1 is transmitted by pressing the button briefly and object 1 and object 2 are transmitted by pressing the button for a long period</p>	
Long button actuation from	0...3...25 s 0...990 ms
<p>This parameter defines the interval at which the device transmits the telegram for object 1 and the telegram for object 2, depending on the selected transmission behaviour. A time from 100 ms to 25.5 s can be set.</p> <p>i The "long button actuation from" time is to be parameterised for a sufficient period, depending on the application case, to prevent simultaneous transmission of the objects.</p>	

After bus voltage return Object 1 (object 2)	no reaction Transmit value
<p>This parameter determines the reaction after the bus voltage returns.</p> <p>Either no telegram or a value parameterised according to the functionality is transmitted on the bus according to the parameterisation.</p> <p>The reaction after the bus voltage returns takes place only after the parameterised "delay after bus voltage returns" expires ("General" parameter page).</p>	
Disabling function	Inactive Active
<p>This parameter enables the disabling function for the channel.</p>	
At the beginning of the disabling function Object 1 (object 2)	no reaction Transmit value
<p>Besides disabling the channel, the device can immediately react when the disabling occurs.</p> <p>Either no telegram or a value parameterised according to the functionality is transmitted on the bus according to the parameterisation.</p> <p>This parameter defines the reaction of the channel at the beginning of the disabling.</p>	
At the end of the disabling function Object 1 (object 2)	no reaction Transmit value
<p>Besides disabling the channel, the device can immediately react at the end of the disabling.</p> <p>Either no telegram or a value parameterised according to the functionality is transmitted on the bus according to the parameterisation.</p> <p>This parameter defines the reaction of the channel at the end of the disabling.</p>	
Object polarity	0 = enabled / 1 = disable 1 = enabled / 0 = disable
<p>This parameter defines the value of the disabling object at which the disabling function is active.</p>	

8.1.8.2 Object list

The following communication objects are available in the "push-button" channel function with the parameterised "short and long button actuation" function. The name can be adjusted with the "Name" parameter.

Object no.	Function	Name	Type	DPT	Flag
653, 669 ..., 701	Short and long button actuation - Object 1 - Switching	K n - Output	1-bit	1,001	C, R, -, T, A
1-bit object to send switching telegrams if the button is briefly pressed (object 1).					

Object no.	Function	Name	Type	DPT	Flag
654, 670, ..., 702	Short and long button actuation - Object 2 - Switching	K n - Output	1-bit	1,001	C, R, -, T, A
1-bit object to send switching telegrams if the button is pressed and held (object 2).					

Object no.	Function	Name	Type	DPT	Flag
665, 681 ..., 713	Short and long button actuation - Object 1 - Switching - Status	K n - Input	1-bit	1,001	C, -, W, -, U
1-bit object for receiving feedback telegrams (ON, OFF) (object 1). This object is visible if the parameter "Short button actuation (object 1)" is parameterised to "TOGGLE".					

Object no.	Function	Name	Type	DPT	Flag
666, 682, ..., 714	Short and long button actuation - Object 2 - Switching - Status	K n - Input	1-bit	1,001	C, -, W, -, U
1-bit object for receiving feedback telegrams (ON, OFF) (object 2). This object is visible if the parameter "Long button actuation (object 2)" is parameterised to "TOGGLE".					

Object no.	Function	Name	Type	DPT	Flag
653, 669 ..., 701	Short and long button actuation - Object 1 - Forced position	K n - Output	2-bit	2,001	C, R, -, T, A

2-bit input object for activating and deactivating the forced position (object 1).

With the value "1", bit 1 of the telegram activates the forced position. The assigned channels are then locked in the state specified by bit 0 ("0" = OFF / "1" = ON). The value "0" in bit 1 deactivates the forced position again.

0x = forcing inactive

10 = forcing active, OFF

11 = forcing active, ON

Object no.	Function	Name	Type	DPT	Flag
654, 670, ..., 702	Short and long button actuation - Object 2 - Forced position	K n - Output	2-bit	2,001	C, R, -, T, A

2-bit input object for activating and deactivating the forced position (object 1).

With the value "1", bit 1 of the telegram activates the forced position. The assigned channels are then locked in the state specified by bit 0 ("0" = OFF / "1" = ON). The value "0" in bit 1 deactivates the forced position again.

0x = forcing inactive

10 = forcing active, OFF

11 = forcing active, ON

Object no.	Function	Name	Type	DPT	Flag
653, 669 ..., 701	Short and long button actuation - Object 1 - Value 0...100%	K n - Output	1-byte	5,001	C, R, -, T, A

1-byte object to send value telegrams if the button is briefly pressed (object 1).

Object no.	Function	Name	Type	DPT	Flag
654, 670, ..., 702	Short and long button actuation - Object 2 - Value 0...100%	K n - Output	1-byte	5,001	C, R, -, T, A

1-byte object to send value telegrams if the button is pressed and held (object 2).

Object no.	Function	Name	Type	DPT	Flag
653, 669 ..., 701	Short and long button actuation - Object 1 - Value 0...255	K n - Output	1-byte	5,010	C, R, -, T, A
1-byte object to send value telegrams if the button is briefly pressed (object 1).					

Object no.	Function	Name	Type	DPT	Flag
654, 670, ..., 702	Short and long button actuation - Object 2 - Value 0...255	K n - Output	1-byte	5,010	C, R, -, T, A
1-byte object to send value telegrams if the button is pressed and held (object 2).					

Object no.	Function	Name	Type	DPT	Flag
653, 669 ..., 701	Short and long button actuation - Object 1 - Value 0...360°	K n - Output	1-byte	5,003	C, R, -, T, A
1-byte object to send value telegrams if the button is briefly pressed (object 1).					

Object no.	Function	Name	Type	DPT	Flag
654, 670, ..., 702	Short and long button actuation - Object 2 - Value 0...360°	K n - Output	1-byte	5,003	C, R, -, T, A
1-byte object to send value telegrams if the button is pressed and held (object 2).					

Object no.	Function	Name	Type	DPT	Flag
653, 669 ..., 701	Short and long button actuation - Object 1 - Value 0...255%	K n - Output	1-byte	5,004	C, R, -, T, A
1-byte object to send value telegrams if the button is briefly pressed (object 1).					

Object no.	Function	Name	Type	DPT	Flag
654, 670, ..., 702	Short and long button actuation - Object 2 - Value 0...255%	K n - Output	1-byte	5,004	C, R, -, T, A
1-byte object to send value telegrams if the button is pressed and held (object 2).					

Object no.	Function	Name	Type	DPT	Flag
653, 669 ..., 701	Short and long button actuation - Object 1 - Value -128...127	K n - Output	1-byte	6,010	C, R, -, T, A
1-byte object to send value telegrams if the button is briefly pressed (object 1).					

Object no.	Function	Name	Type	DPT	Flag
654, 670, ..., 702	Short and long button actuation - Object 2 - Value -128...127	K n - Output	1-byte	6,010	C, R, -, T, A
1-byte object to send value telegrams if the button is pressed and held (object 2).					

Object no.	Function	Name	Type	DPT	Flag
653, 669 ..., 701	Short and long button actuation - Object 1 - Value 0...65535	K n - Output	2-byte	7,001	C, R, -, T, A
2-byte object to send value telegrams if the button is briefly pressed (object 1).					

Object no.	Function	Name	Type	DPT	Flag
654, 670, ..., 702	Short and long button actuation - Object 2 - Value 0...65535	K n - Output	2-byte	7,001	C, R, -, T, A
2-byte object to send value telegrams if the button is pressed and held (object 2).					

Object no.	Function	Name	Type	DPT	Flag
653, 669 ..., 701	Short and long button actuation - Object 1 - Colour temperature value	K n - Output	2-byte	7,600	C, R, -, T, A
2-byte object to send value telegrams if the button is briefly pressed (object 1).					

Object no.	Function	Name	Type	DPT	Flag
654, 670, ..., 702	Short and long button actuation - Object 2 - Colour temperature value	K n - Output	2-byte	7,600	C, R, -, T, A
2-byte object to send value telegrams if the button is pressed and held (object 2).					

Object no.	Function	Name	Type	DPT	Flag
653, 669 ..., 701	Short and long button actuation - Object 1 - Value -32768...32767	K n - Output	2-byte	8,001	C, R, -, T, A
2-byte object to send value telegrams if the button is briefly pressed (object 1).					

Object no.	Function	Name	Type	DPT	Flag
654, 670, ..., 702	Short and long button actuation - Object 2 - Value -32768...32767	K n - Output	2-byte	8,001	C, R, -, T, A
2-byte object to send value telegrams if the button is pressed and held (object 2).					

Object no.	Function	Name	Type	DPT	Flag
653, 669 ..., 701	Short and long button actuation - Object 1 - Temperature value	K n - Output	2-byte	9,001	C, R, -, T, A
2-byte object to send temperature values if the button is briefly pressed (object 1).					

Object no.	Function	Name	Type	DPT	Flag
654, 670, ..., 702	Short and long button actuation - Object 2 - Temperature value	K n - Output	2-byte	9,001	C, R, -, T, A
2-byte object to send temperature values if the button is pressed and held (object 2).					

Object no.	Function	Name	Type	DPT	Flag
653, 669 ..., 701	Short and long button actuation - Object 1 - Brightness value	K n - Output	2-byte	9,004	C, R, -, T, A
2-byte object to transmit brightness values if the button is briefly pressed (object 1).					

Object no.	Function	Name	Type	DPT	Flag
654, 670, ..., 702	Short and long button actuation - Object 2 - Brightness value	K n - Output	2-byte	9,004	C, R, -, T, A
2-byte object to send brightness values if the button is pressed and held (object 2).					

Object no.	Function	Name	Type	DPT	Flag
653, 669 ..., 701	Short and long button actuation - Object 1 - Scene number 1...64	K n - Output	1-byte	18,001	C, R, -, T, A
1-byte object to send scene values if the button is briefly pressed (object 1).					

Object no.	Function	Name	Type	DPT	Flag
654, 670, ..., 702	Short and long button actuation - Object 2 - Scene number 1...64	K n - Output	1-byte	18,001	C, R, -, T, A
1-byte object to send scene values if the button is pressed and held (object 2).					

Object no.	Function	Name	Type	DPT	Flag
653, 669 ..., 701	Short and long button actuation - Object 1 - Colour temperature value and brightness value	K n - Output	6-byte	249,60 0	C, R, -, T, A
6-byte object used to transmit a colour temperature value, a brightness value and the adjustment time in the actuator (object 1). The actuator sets the received values during the adjustment time.					
<p>i These objects are visible only if "Short button actuation (object 1) = DPT 249.600 colour temperature value + brightness".</p>					

Object no.	Function	Name	Type	DPT	Flag
654, 670, ..., 702	Short and long button actuation - Object 2 - Colour temperature value and brightness value	K n - Output	6-byte	249,60 0	C, R, -, T, A
6-byte object used to transmit a colour temperature value, a brightness value and the adjustment time in the actuator (object 2). The actuator sets the received values during the adjustment time.					
<p>i These objects are visible only if "Long button actuation (object 2) = DPT 249.600 colour temperature value + brightness".</p>					

Object no.	Function	Name	Type	DPT	Flag
653, 669 ..., 701	Short and long button actuation - Object 1 - Operating mode	K n - Output	1-byte	20,102	C, R, -, T, A
<p>1-byte object for switching a room temperature controller between the Comfort, Standby, Night and Frost/heat protection operating modes.</p> <p>This object is only visible if "Function = operating mode switchover".</p>					
654, 670, ..., 702	Short and long button actuation - Object 2 - Operating mode	K n - Output	1-byte	20,102	C, R, -, T, A
<p>1-byte object for switching a room temperature controller between the Comfort, Standby, Night and Frost/heat protection operating modes.</p> <p>This object is only visible if "Function = operating mode switchover".</p>					
665, 681, ..., 713	Short and long button actuation - Object 1 - Operating mode - Status	K n - Input	1-byte	20,102	C, -, W, -, U
<p>1-byte object for receiving the operating mode of a room temperature controller.</p> <p>This object is only visible if "Function = operating mode switchover".</p>					
666, 682, ..., 714	Short and long button actuation - Object 2 - Operating mode - Status	K n - Input	1-byte	20,102	C, -, W, -, U
<p>1-byte object for receiving the operating mode of a room temperature controller.</p> <p>This object is only visible if "Function = operating mode switchover".</p>					
653, 669 ..., 701	Short and long button actuation - Object 1 - Operating mode - Forced	K n - Output	1-byte	20,102	C, R, -, T, A
<p>1-byte object for switching a room temperature controller under forced control between the Automatic, Comfort, Standby, Night and Frost / heat protection operating modes.</p> <p>This object is only visible if "Function = forced operating mode switchover".</p>					

Object no.	Function	Name	Type	DPT	Flag
654, 670, ..., 702	Short and long button actuation - Object 2 - Operating mode - Forced	K n - Output	1-byte	20,102	C, R, -, T, A

1-byte object for switching a room temperature controller under forced control between the Automatic, Comfort, Standby, Night and Frost / heat protection operating modes.

This object is only visible if "Function = forced operating mode switchover".

Object no.	Function	Name	Type	DPT	Flag
665, 681, ..., 713	Short and long button actuation - Object 1 - Operating mode - Forcing - Status	K n - Input	1-byte	20,102	C, -, W, -, U

1-byte object for receiving the operating mode of a room temperature controller.

This object is only visible if "Function = forced operating mode switchover".

Object no.	Function	Name	Type	DPT	Flag
666, 682, ..., 714	Short and long button actuation - Object 2 - Operating mode - Forcing - Status	K n - Input	1-byte	20,102	C, -, W, -, U

1-byte object for receiving the operating mode of a room temperature controller.

This object is only visible if "Function = forced operating mode switchover".

Object no.	Function	Name	Type	DPT	Flag
653, 669 ..., 701	Short and long button actuation - Object 1 - Presence	K n - Output	1-bit	1,018	C, R, -, T, A

1-bit object for changing over the presence status of a room temperature controller.

This object is only visible if "Function = presence function".

Object no.	Function	Name	Type	DPT	Flag
654, 670, ..., 702	Short and long button actuation - Object 2 - Presence	K n - Output	1-bit	1,018	C, R, -, T, A

1-bit object for changing over the presence status of a room temperature controller.

This object is only visible if "Function = presence function".

Object no.	Function	Name	Type	DPT	Flag
665, 681, ..., 713	Short and long button actuation - Object 1 - Presence - Status	K <i>n</i> - Input	1-bit	1,018	C, -, W, -, U

1-bit object for receiving the presence status of a room temperature controller.
This object is only visible if "Function = presence function".

Object no.	Function	Name	Type	DPT	Flag
666, 682, ..., 714	Short and long button actuation - Object 2 - Presence - Status	K <i>n</i> - Input	1-bit	1,018	C, -, W, -, U

1-bit object for receiving the presence status of a room temperature controller.
This object is only visible if "Function = presence function".

Object no.	Function	Name	Type	DPT	Flag
653, 669 ..., 701	Short and long button actuation - Object 1 - Setpoint temperature shift	K <i>n</i> - Output	2-byte	9,002	C, R, -, T, A

2-byte object for specification of a target temperature shift in Kelvin. The value "0" means that no shift is active . Values can be specified between -670760 K and 670760 K.

This object is visible only if "function = target temperature shift" and "type of target temperature shift = above relative temperature value".

Object no.	Function	Name	Type	DPT	Flag
654, 670, ..., 702	Short and long button actuation - Object 2 - Setpoint temperature shift	K <i>n</i> - Output	2-byte	9,002	C, R, -, T, A

2-byte object for specification of a target temperature shift in Kelvin. The value "0" means that no shift is active . Values can be specified between -670760 K and 670760 K.

This object is visible only if "function = target temperature shift" and "type of target temperature shift = above relative temperature value".

Object no.	Function	Name	Type	DPT	Flag
665, 681, ..., 713	Short and long button actuation - Object 1 - Setpoint temperature shift - Status	K <i>n</i> - Input	2-byte	9,002	C, -, W, -, U
<p>2-byte object for receiving the status of the current target temperature shift in Kelvin. This object is visible only if "function = target temperature shift" and "type of target temperature shift = above relative temperature value".</p>					

Object no.	Function	Name	Type	DPT	Flag
666, 682, ..., 714	Short and long button actuation - Object 2 - Setpoint temperature shift - Status	K <i>n</i> - Input	2-byte	9,002	C, -, W, -, U
<p>2-byte object for receiving the status of the current target temperature shift in Kelvin. This object is visible only if "function = target temperature shift" and "type of target temperature shift = above relative temperature value".</p>					

Object no.	Function	Name	Type	DPT	Flag
653, 669 ..., 701	Short and long button actuation - Object 1 - Setpoint temperature shift	K <i>n</i> - Output	1-byte	6,010	C, R, -, T, A
<p>1-byte object for specification of a target temperature shift. The value "0" means that no shift is active. The value is depicted in a two's complement in the positive or negative direction. This object is visible only if "function = target temperature shift" and "type of target temperature shift = above meter value".</p>					

Object no.	Function	Name	Type	DPT	Flag
654, 670, ..., 702	Short and long button actuation - Object 2 - Setpoint temperature shift	K <i>n</i> - Output	1-byte	6,010	C, R, -, T, A
<p>1-byte object for specification of a target temperature shift. The value "0" means that no shift is active. The value is depicted in a two's complement in the positive or negative direction. This object is visible only if "function = target temperature shift" and "type of target temperature shift = above meter value".</p>					

Object no.	Function	Name	Type	DPT	Flag
665, 681, ..., 713	Short and long button actuation - Object 1 - Setpoint temperature shift - Status	K <i>n</i> - Input	1-byte	6,010	C, -, W, -, U

1-byte object to receive the status of the current target temperature shift.

This object is visible only if "function = target temperature shift" and "type of target temperature shift = above meter value".

Object no.	Function	Name	Type	DPT	Flag
666, 682, ..., 714	Short and long button actuation - Object 2 - Setpoint temperature shift - Status	K <i>n</i> - Input	1-byte	6,010	C, -, W, -, U

1-byte object to receive the status of the current target temperature shift.

This object is visible only if "function = target temperature shift" and "type of target temperature shift = above meter value".

Object no.	Function	Name	Type	DPT	Flag
653, 669 ..., 701	Short and long button actuation - Object 1 - Colour value (RGB)	K <i>n</i> - Output	3-byte	232,60 0	C, R, -, T, A

3-byte object to send RBG values if the button is briefly pressed (object 1).

This object is visible only if "colour control = combi object: RGB or combi object: RGBW" was selected.

Object no.	Function	Name	Type	DPT	Flag
654, 670, ..., 702	Short and long button actuation - Object 2 - Colour value (RGB)	K <i>n</i> - Output	3-byte	232,60 0	C, R, -, T, A

3-byte object to send RBG values if the button is pressed and held (object 2).

This object is visible only if "colour control = combi object: RGB or combi object: RGBW" was selected.

Object no.	Function	Name	Type	DPT	Flag
653, 669 ..., 701	Short and long button actuation - Object 1 - Colour value (RGBW)	K <i>n</i> - Output	6-byte	251,60 0	C, R, -, T, A

6-byte object to send RBGW values if the button is briefly pressed (object 1).

This object is visible only if "colour control = combi object: RGB or combi object: RGBW" was selected.

Object no.	Function	Name	Type	DPT	Flag
654, 670, ..., 702	Short and long button actuation - Object 2 - Colour value (RGBW)	K n - Output	6-byte	251,600	C, R, -, T, A
<p>6-byte object to send RGBW values if the button is pressed and held (object 2). This object is visible only if "colour control = combi object: RGB or combi object: RGBW" was selected.</p>					

Object no.	Function	Name	Type	DPT	Flag
655, 671 ..., 703	Short and long button actuation - Object 1 - Red colour value	K n - Output	1-byte	5,001	C, R, -, T, A
<p>1-byte object to send the red colour value if the button is briefly pressed (object 1). This object is visible only if "colour control = individual object: RGB or individual object: RGBW" was selected.</p>					

Object no.	Function	Name	Type	DPT	Flag
659, 675 ..., 707	Short and long button actuation - Object 2 - Red colour value	K n - Output	1-byte	5,001	C, R, -, T, A
<p>1-byte object to send the red colour value if the button is pressed and held (object 2). This object is visible only if "colour control = individual object: RGB or individual object: RGBW" was selected.</p>					

Object no.	Function	Name	Type	DPT	Flag
656, 672 ..., 704	Short and long button actuation - Object 1 - Green colour value	K n - Output	1-byte	5,001	C, R, -, T, A
<p>1-byte object to send the green colour value if the button is briefly pressed (object 1). This object is visible only if "colour control = individual object: RGB or individual object: RGBW" was selected.</p>					

Object no.	Function	Name	Type	DPT	Flag
660, 676 ..., 708	Short and long button actuation - Object 2 - Green colour value	K n - Output	1-byte	5,001	C, R, -, T, A
<p>1-byte object to send the green colour value if the button is pressed and held (object 2). This object is visible only if "colour control = individual object: RGB or individual object: RGBW" was selected.</p>					

Object no.	Function	Name	Type	DPT	Flag
657, 673 ..., 705	Short and long button actuation - Object 1 - Blue colour value	K n - Output	1-byte	5,001	C, R, -, T, A
<p>1-byte object to send the blue colour value if the button is briefly pressed (object 1). This object is visible only if "colour control = individual object: RGB or individual object: RGBW" was selected.</p>					

Object no.	Function	Name	Type	DPT	Flag
661, 677 ..., 709	Short and long button actuation - Object 2 - Blue colour value	K n - Output	1-byte	5,001	C, R, -, T, A
<p>1-byte object to send the blue colour value if the button is pressed and held (object 2). This object is visible only if "colour control = individual object: RGB or individual object: RGBW" was selected.</p>					

Object no.	Function	Name	Type	DPT	Flag
655, 671 ..., 703	Short and long button actuation - Object 1 - Colour hue (H)	K n - Output	1-byte	5,003	C, R, -, T, A
<p>1-byte object to send the colour hue if the button is briefly pressed (object 1). This object is visible only if "colour control = individual object: HSV or individual object: HSVW" was selected.</p>					

Object no.	Function	Name	Type	DPT	Flag
659, 675 ..., 707	Short and long button actuation - Object 2 - Colour hue (H)	K n - Output	1-byte	5,003	C, R, -, T, A
<p>1-byte object to send the colour hue if the button is pressed and held (object 2). This object is visible only if "colour control = individual object: HSV or individual object: HSVW" was selected.</p>					

Object no.	Function	Name	Type	DPT	Flag
656, 672 ..., 704	Short and long button actuation - Object 1 - Saturation (S)	K n - Output	1-byte	5,001	C, R, -, T, A
<p>1-byte object to send the saturation if the button is briefly pressed (object 1). This object is visible only if "colour control = individual object: HSV or individual object: HSVW" was selected.</p>					

Object no.	Function	Name	Type	DPT	Flag
660, 676 ..., 708	Short and long button actuation - Object 2 - Saturation (S)	K n - Output	1-byte	5,001	C, R, -, T, A
1-byte object to send the saturation if the button is pressed and held (object 2). This object is visible only if "colour control = individual object: HSV or individual object: HSVW" was selected.					
657, 673 ..., 705	Short and long button actuation - Object 1 - Brightness value (V)	K n - Output	1-byte	5,001	C, R, -, T, A
1-byte object to send the brightness value if the button is briefly pressed (object 1). This object is visible only if "colour control = individual object: HSV or individual object: HSVW" was selected.					
661, 677 ..., 709	Short and long button actuation - Object 2 - Brightness value (V)	K n - Output	1-byte	5,001	C, R, -, T, A
1-byte object to send the brightness value if the button is pressed and held (object 2). This object is visible only if "colour control = individual object: HSV or individual object: HSVW" was selected.					
658, 674 ..., 706	Short and long button actuation - Object 1 - White value (W)	K n - Output	1-byte	5,001	C, R, -, T, A
1-byte object to send the white value if the button is briefly pressed (object 1). This object is visible only if "colour control = individual object: HSVW" was selected.					
662, 678 ..., 710	Short and long button actuation - Object 2 - White value (W)	K n - Output	1-byte	5,001	C, R, -, T, A
1-byte object to send the white value if the button is pressed and held (object 2). This object is visible only if "colour control = individual object: HSVW" was selected.					

Object no.	Function	Name	Type	DPT	Flag
664, 680, ..., 712	Short and long button actuation - Object 1/2 - Disabling	K n - Input	1-bit	1,003	C, -, W, -, U
1-bit object for activating or deactivating the disabling function. The object polarity can be parameterised.					

8.1.9 Room temperature control point

In the "push-button" channel function, the push-button can be parameterised for the "room temperature control point" function. The ETS indicates up to three communication objects for the "room temperature control point" function. The parameters can be used to determine the value the "RTC control point" objects obtain when the button is pressed. Furthermore, the behaviour of the channel after the bus voltage returns can be parameterised and a disabling function activated. No distinction is made between a brief or long press.

The "room temperature control point" channel function can be used to actuate a KNX room temperature controller.

The room temperature control point itself is not involved in the temperature control process. It allows the user to operate the single-room regulation from different points in the room. The room temperature control point can also be used to control central heating control devices located, for example, in a sub-distribution unit.

Typical KNX room temperature controllers generally offer different ways of influencing the room temperature control:

- Operating mode switchover:
Switching between different modes of operation (e. g. "Comfort", "Night" ...) with different setpoint temperatures assigned to each mode by the controller.
- Presence function:
Signalling the presence of a person in a room. The signalling may also be combined with a configured switchover in the mode of operation.
- Target temperature shift:
Adjustment of the target temperature via a temperature offset (DPT 9.002) or via levels (DPT 6.010).

The room temperature control point is operated with the button functions of the device. In this way, it is possible to completely control a room temperature controller by changing the operating mode, specifying the presence function or adjusting the target temperature shift.

8.1.9.1 Operating mode switchover

Switchover of the controller operating mode can be effected in accordance with the standard function block for room temperature controllers defined in the KNX handbook using two 1-byte communication objects. The operating mode can be switched over with the normal and with the forced objects. The object "RTC control point - Operating mode" allows different modes to be selected:

- Comfort
- Standby
- Night
- Frost/heat protection
- Switchover: comfort/standby
- Switchover: comfort/night
- Switchover: standby/night
- Switchover: comfort/standby/night

The communication object "RTC control point - Operating mode - Forcing" is of higher priority. It permits forced switching between the following modes of operation:

- Forcing inactive (auto)
- Comfort
- Standby
- Night
- Frost/heat protection
- Switchover: comfort/standby
- Switchover: comfort/night
- Switchover: standby/night
- Switchover: comfort/standby/night
- Toggle: forced inactive (auto) / comfort
- Toggle: forced inactive (auto) / standby
- Toggle: forced inactive (auto) / night
- Switchover: forced inactive (auto) / frost/heat protection

The operating mode transmitted to the bus when pressing the button of the room temperature control point is defined by the parameter "When pressed". Depending on the parameterised operating concept, either pressing a button will activate one of the above modes or each button actuation will toggle between two or three modes.

- i It is recommended to visualise the state when switching over. The visualisation can take place by means of a switch setting or by a status LED, actuated, for example, via the output of the push-button interface.

8.1.9.2 Presence function

All channels whose functionality is set to "presence function" have the two communication objects "RTC control point - Presence" and "RTC control point - Presence - Status". The "When pressed" parameter determines the object value transmitted to the bus in the event of button actuation.

8.1.9.3 Target temperature shift

Another function of the room temperature control point that is available is the target temperature shift. It makes use of either two 2-byte communication objects with datapoint type 9.002 or two 1-byte communication objects with datapoint type 6.010 (integer with sign).

This control point function allows the basic setpoint for the temperature to be shifted on a room temperature controller by pressing a button. The control point is usually operated in the same way as the main control point. A button configured as target temperature shift reduces or increases the target temperature shift value each time the button is pressed. The direction of the value adjustment is defined by the parameters "Increase target temperature difference when pressed" or "Reduce target temperature difference when pressed".

Communication with main controller

To enable the device to shift the target temperature on a room temperature controller, the controller must have input and output objects for the target temperature shift. In this case, the output object of the controller must be connected to the input object of the room temperature control point, and the input object of the controller must be connected to the output object of the room temperature control point in each case via their own group address.

All objects are of the same datapoint type and have the same value range. A target temperature shift is interpreted by count values: a shift in positive direction is expressed by positive values, whereas a shift in negative direction is represented by negative object values. An object value of "0" means that no target temperature shift has been set.

The room temperature control points detect the current position of the setpoint adjustment by means of the object "RTC control point - Target temperature shift - Status" of the room temperature control point connected to the room temperature controller. Starting from the value of the communication object, the setpoint is adjusted in the configured direction each time a button is pressed on a room temperature control point. Each time the setpoint is adjusted, the new shift by means of the object "RTC control point - Target temperature shift" of the room temperature control point is sent to the room temperature regulator.

With the "by counter value" function, the individual levels are weighted by the controller itself.

This requires that the respective communication objects are connected to all room temperature control points and the controller. The feedback information from the controller enables the room temperature control point to continue the adjustment at any time at the right point.

8.1.9.4 Table of parameters

The following parameters are available in the "push-button" channel function with the parameterised "room temperature control point" function.

Function	Operating mode switchover Forced oper. mode switchover Presence function Target temperature shift
A room temperature control point can optionally switch over (force) the operating mode with normal or high priority, change the presence status or change the current room temperature setpoint value. With regard to the setting of this parameter, the ETS shows further parameters.	
When pressed	Comfort Standby Night Frost/heat protection Switchover: comfort/standby Switchover: comfort/night Switchover: standby/night Switchover: comfort/standby/night
If the room temperature control point is intended to change over the operating mode of the room temperature controller with normal priority, the extension can either switch on a defined operating mode or switch between different operating modes when operated.	

When pressed	Forcing inactive (auto) Comfort Standby Night Frost/heat protection Switchover: comfort/standby Switchover: comfort/night Switchover: standby/night Switchover: comfort/standby/night Toggle: forced inactive (auto) / comfort Toggle: forced inactive (auto) / standby Toggle: forced inactive (auto) / night Switchover: forced inactive (auto) / frost/heat protection
--------------	--

If the room temperature control point is intended to switch the operating mode of the room temperature controller with high priority, the extension can either enable change-over with normal priority (auto), switch on a defined operating mode with high priority or switch different operating modes when operated.

When pressed	Presence ON Presence OFF Presence TOGGLE
--------------	---

The room temperature control point can switch the presence state of the room temperature controller either on or off in a defined way or the extension can switch between both states ("Presence TOGGLE") by pressing the button.
 This parameter is only visible if "Function = presence function".

Target temperature shift	By relative temperature value By meter value
--------------------------	--

Depending on the setting of the "Target temperature shift" parameter, the shift takes place by means of the 2-byte communication object in accordance with KNX DPT 9.002 or KNX DPT 6.010.
 This parameter is visible only if "function = target temperature shift".

When pressed	+2 K +1.5 K +1 K +0.5 K -0.5 K -1 K -1.5 K -2 K
--------------	---

The temperature difference is defined in Kelvin here by which the setpoint temperature will be shifted up or down when the button is pressed.

To shift the target temperature value, the room temperature control point uses the two communication objects "RTC control point - Target temperature shift" and "RTC control point - Target temperature shift - Status".

The communication object "RTC control point - Target temperature shift - Status" informs the room temperature control point about the current state of the room temperature controller. Based on this value and the parameter here, the room temperature control point calculates the new level value, which it sends to the room temperature controller via the communication object "RTC control point - Target temperature shift".

This parameter is visible only if "function = target temperature shift" and "type of target temperature shift = above relative temperature value".

When pressed	Increase setpoint temperature Reduce setpoint temperature
--------------	---

The direction of the target temperature shift is defined here at the room temperature control point.

To shift the target temperature value, the room temperature control point uses the two communication objects "RTC control point - Target temperature shift" and "RTC control point - Target temperature shift - Status".

The communication object "RTC control point - Target temperature shift - Status" informs the extension about the current state of the room temperature controller. Based on this value and the parameter here, the room temperature control point calculates the new level value, which it sends to the room temperature controller via the communication object "RTC control point - Target temperature shift".

This parameter is visible only if "function = target temperature shift" and "type of target temperature shift = above meter value".

After bus voltage return	no reaction Transmit current state Comfort Standby Night Frost/heat protection
--------------------------	--

This parameter determines the reaction after the bus voltage returns.
 Either no telegram, a telegram according to the current input state at the channel, a comfort telegram, a standby telegram, a night telegram or a frost/heat protection telegram is transmitted on the bus according to the parameterisation.
 The reaction after the bus voltage returns takes place only after the parameterised "delay after bus voltage returns" expires ("General" parameter page).
 Visible only if "Functionality = operating mode change-over".

After bus voltage return	no reaction Transmit current state Forcing inactive (auto) Comfort Standby Night Frost/heat protection
--------------------------	---

This parameter determines the reaction after the bus voltage returns.
 Either no telegram, a telegram according to the current input state at the channel, a forcing inactive (auto) telegram, a comfort telegram, a standby telegram, a night telegram or a frost/heat protection telegram is transmitted on the bus according to the parameterisation.
 The reaction after the bus voltage returns takes place only after the parameterised "delay after bus voltage returns" expires ("General" parameter page).
 Visible only if "Functionality = forced operating mode change-over".

After bus voltage return	no reaction Transmit current state Presence ON Presence OFF Presence TOGGLE
--------------------------	--

This parameter determines the reaction after the bus voltage returns.
 Either no telegram, a telegram according to the current input state at the channel or a presence telegram is transmitted on the bus according to the parameterisation.
 The reaction after the bus voltage returns takes place only after the parameterised "delay after bus voltage returns" expires ("General" parameter page).
 This parameter is only visible if "Function = presence function".

After bus voltage return	no reaction +2 K +1.5 K +1 K +0.5 K -0.5 K -1 K -1.5 K -2 K
--------------------------	--

This parameter determines the reaction after the bus voltage returns.
 Either no telegram or a temperature value telegram is transmitted on the bus according to the parameterisation.
 The reaction after the bus voltage returns takes place only after the parameterised "delay after bus voltage returns" expires ("General" parameter page).
 This parameter is visible only if "function = target temperature shift" and "type of target temperature shift = above relative temperature value".

After bus voltage return	no reaction Increase setpoint temperature Reduce setpoint temperature
--------------------------	--

This parameter determines the reaction after the bus voltage returns.
 Either no telegram or a counting value telegram is transmitted on the bus according to the parameterisation.
 The reaction after the bus voltage returns takes place only after the parameterised "delay after bus voltage returns" expires ("General" parameter page).
 This parameter is visible only if "function = target temperature shift" and "type of target temperature shift = above meter value".

Disabling function	Inactive Active
--------------------	---------------------------

This parameter enables the disabling function for the channel.

At the beginning of the disabling function	no reaction Comfort Standby Night Frost/heat protection
--	--

Besides disabling the channel, the device can immediately react when the disabling occurs.
 This parameter defines the reaction of the channel at the beginning of the disabling.
 Visible only if "Functionality = operating mode change-over".

At the beginning of the disabling function	no reaction Forcing inactive (auto) Comfort Standby Night Frost/heat protection
--	---

Besides disabling the channel, the device can immediately react when the disabling occurs.

This parameter defines the reaction of the channel at the beginning of the disabling. Visible only if "Functionality = forced operating mode change-over".

At the beginning of the disabling function	no reaction Presence ON Presence OFF Presence TOGGLE
--	--

Besides disabling the channel, the device can immediately react when the disabling occurs.

This parameter defines the reaction of the channel at the beginning of the disabling. This parameter is only visible if "Function = presence function".

At the beginning of the disabling function	no reaction +2 K +1.5 K +1 K +0.5 K -0.5 K -1 K -1.5 K -2 K
--	--

Besides disabling the channel, the device can immediately react when the disabling occurs.

This parameter defines the reaction of the channel at the beginning of the disabling. This parameter is visible only if "function = target temperature shift" and "type of target temperature shift = above relative temperature value".

<p>At the beginning of the disabling function</p>	<p>no reaction Increase setpoint temperature Reduce setpoint temperature</p>
<p>Besides disabling the channel, the device can immediately react when the disabling occurs. This parameter defines the reaction of the channel at the beginning of the disabling. This parameter is visible only if "function = target temperature shift" and "type of target temperature shift = above meter value".</p>	
<p>At the end of the disabling function</p>	<p>no reaction Transmit current state Comfort Standby Night Frost/heat protection</p>
<p>Besides disabling the channel, the device can immediately react at the end of the disabling. This parameter defines the reaction of the channel at the end of the disabling. Visible only if "Functionality = operating mode change-over".</p>	
<p>At the end of the disabling function</p>	<p>no reaction Transmit current state Forcing inactive (auto) Comfort Standby Night Frost/heat protection</p>
<p>Besides disabling the channel, the device can immediately react at the end of the disabling. This parameter defines the reaction of the channel at the end of the disabling. Visible only if "Functionality = forced operating mode change-over".</p>	
<p>At the end of the disabling function</p>	<p>no reaction Transmit current state Presence ON Presence OFF Presence TOGGLE</p>
<p>Besides disabling the channel, the device can immediately react at the end of the disabling. This parameter defines the reaction of the channel at the end of the disabling. This parameter is only visible if "Function = presence function".</p>	

At the end of the disabling function	no reaction +2 K +1.5 K +1 K +0.5 K -0.5 K -1 K -1.5 K -2 K
Besides disabling the channel, the device can immediately react at the end of the disabling. This parameter defines the reaction of the channel at the end of the disabling. This parameter is visible only if "function = target temperature shift" and "type of target temperature shift = above relative temperature value".	
At the end of the disabling function	no reaction Increase setpoint temperature Reduce setpoint temperature
Besides disabling the channel, the device can immediately react at the end of the disabling. This parameter defines the reaction of the channel at the end of the disabling. This parameter is visible only if "function = target temperature shift" and "type of target temperature shift = above meter value".	
Object polarity	0 = enabled / 1 = disable 1 = enabled / 0 = disable
This parameter defines the value of the disabling object at which the disabling function is active.	

8.1.9.5 Object list

The following communication objects are available in the "push-button" channel function with the parameterised "room temperature control point" function. The name can be adjusted with the "Name" parameter.

Object no.	Function	Name	Type	DPT	Flag
966, 980, ..., 1008	RTC control point - Operating mode	K n - Output	1-byte	20,102	C, R, -, T, A
1-byte object for switching a room temperature controller between the Comfort, Standby, Night and Frost/heat protection operating modes. This object is only visible if "Function = operating mode switchover".					

Object no.	Function	Name	Type	DPT	Flag
967, 981, ..., 1009	RTC control point - Operating mode - Status	K n - Input	1-byte	20,102	C, -, W, -, U
1-byte object for receiving the operating mode of a room temperature controller. This object is only visible if "Function = operating mode switchover".					

Object no.	Function	Name	Type	DPT	Flag
966, 980, ..., 1008	RTC control point - Operating mode - Forced	K n - Output	1-byte	20,102	C, R, -, T, A
1-byte object for switching a room temperature controller under forced control between the Automatic, Comfort, Standby, Night and Frost / heat protection operating modes. This object is only visible if "Function = forced operating mode switchover".					

Object no.	Function	Name	Type	DPT	Flag
967, 981, ..., 1009	RTC control point - Operating mode - Forced - Status	K n - Input	1-byte	20,102	C, -, W, -, U
1-byte object for receiving the operating mode of a room temperature controller. This object is only visible if "Function = forced operating mode switchover".					

Object no.	Function	Name	Type	DPT	Flag
966, 980, ..., 1008	RTC control point - Presence	K n - Output	1-bit	1,018	C, R, -, T, A
1-bit object for changing over the presence status of a room temperature controller. This object is only visible if "Function = presence function".					

Object no.	Function	Name	Type	DPT	Flag
967, 981, ..., 1009	RTC control point - Presence - Status	K <i>n</i> - Input	1-bit	1,018	C, -, W, -, U

1-bit object for receiving the presence status of a room temperature controller.
This object is only visible if "Function = presence function".

Object no.	Function	Name	Type	DPT	Flag
966, 980, ..., 1008	RTC control point - Target temperature shift	K <i>n</i> - Output	2-byte	9,002	C, R, -, T, A

2-byte object for specification of a target temperature shift in Kelvin. The value "0" means that no shift is active . Values can be specified between -670760 K and 670760 K.

This object is visible only if "function = target temperature shift" and "type of target temperature shift = above relative temperature value".

Object no.	Function	Name	Type	DPT	Flag
967, 981, ..., 1009	RTC control point - Target temperature shift - Status	K <i>n</i> - Input	2-byte	9,002	C, -, W, -, U

2-byte object for receiving the status of the current target temperature shift in Kelvin.
This object is visible only if "function = target temperature shift" and "type of target temperature shift = above relative temperature value".

Object no.	Function	Name	Type	DPT	Flag
966, 980, ..., 1008	RTC control point - Target temperature shift	K <i>n</i> - Output	1-byte	6,010	C, R, -, T, A

1-byte object for specification of a target temperature shift. The value "0" means that no shift is active . The value is depicted in a two's complement in the positive or negative direction.

This object is visible only if "function = target temperature shift" and "type of target temperature shift = above meter value".

Object no.	Function	Name	Type	DPT	Flag
967, 981, ..., 1009	RTC control point - Target temperature shift - Status	K <i>n</i> - Input	1-byte	6,010	C, -, W, -, U

1-byte object to receive the status of the current target temperature shift.

This object is visible only if "function = target temperature shift" and "type of target temperature shift = above meter value".

Object no.	Function	Name	Type	DPT	Flag
968, 982, ..., 1010	RTC control point - Disabling	K <i>n</i> - Input	1-bit	1,003	C, -, W, -, U
1-bit object for activating or deactivating the disabling function. The object polarity can be parameterised.					

8.2 Switch

The channel function can be parameterised for each channel. The following functions are available for each output object in the "switch" channel function:

- Switching
- Forced position
- Value transmitter
- Scene extension
- Room temperature control point

The ETS provides the corresponding parameters and communication objects dynamically for the function according to the parameterised function.

The debouncing time is to be parameterised separately for each channel. One or two output objects can be parameterised and actuated in the "switch" channel function. The available functions can be selected and combined independently of each other for both output objects. A disabling function can be activated optionally for each switch channel output object.

A command can be parameterised when closing and when opening the contact for each switch channel output object.

- i** The "switch" channel function is recommended if telegrams are to be transmitted cyclically on the KNX. This allows monitoring, similar to the heartbeat, to be implemented or rising and falling edges - like with the switch - to be evaluated regardless of the time.

8.2.1 Table of parameters

The following parameters are generally available for the "switch" channel function.

Number of objects	1 2
This parameter defines the number of output objects actuated in the "switch" channel function for each channel.	
Debounce time	4 ... 10 ... 255 ms
This parameter specifies the software debouncing time. A signal edge is evaluated at the input after a delay based on this time.	

The following parameters are available for each output object for the "switch" channel function.

Function	Switching Forced position Value transmitter Scene extension Room temperature control point
This parameter determines the function of the switch connected to the channel for each output object.	

8.2.2 Switching

In the "switch" channel function, each object of the switch can be parameterised separately for the "switching" function. The ETS indicates up to three communication objects for each switch channel output object for the "switching" function. The parameters can be used to determine which value the "switch" object receives when the contact is closed or opened. Furthermore, the behaviour of the switch channel output object after the bus voltage returns can be parameterised and a disabling function activated. The switching status of the switch channel output objects can be transmitted cyclically on the bus. No distinction is made between a brief or long press.

8.2.2.1 Table of parameters

The following parameters are available in the "switch" channel function with the parameterised "switching" function for each switch channel output object.

When closing the contact	no reaction ON OFF TOGGLE
This parameter determines the reaction when closing the contact of the switch. With "TOGGLE", the ETS application program makes the status object available.	
When opening the contact	no reaction ON OFF TOGGLE
This parameter determines the reaction when opening the contact of the switch. With "TOGGLE", the ETS application program makes the status object available.	
After bus voltage return	no reaction Transmit current state ON OFF
This parameter determines the reaction after the bus voltage returns. Either no telegram, a telegram according to the current input state at the channel, an ON telegram or an OFF telegram is transmitted on the bus according to the parameterisation. The reaction after the bus voltage returns takes place only after the parameterised "delay after bus voltage returns" expires ("General" parameter page).	

Send switching status cyclically	Inactive Active
<p>The switching status of the switch channel output objects can be transmitted cyclically on the bus.</p> <p>This parameter enables the cyclical transmission.</p>	
Cycle time	0...24 h 0...5...59 min 0...59 s
<p>This parameter defines the interval at which the switching status is transmitted on the bus.</p> <p>The cycle time can be parameterised between 3 seconds and 24 hours.</p>	
Disabling function	Inactive Active
<p>This parameter enables the disabling function for the channel.</p>	
At the beginning of the disabling function	no reaction ON OFF TOGGLE
<p>Besides disabling the channel, the device can immediately react when the disabling occurs.</p> <p>This parameter defines the reaction of the channel at the beginning of the disabling.</p> <p>i With "TOGGLE", the feedback of an actuator is to be connected with the "switching" object if the status object is not already made available by the settings of the parameter "When closing the contact" or "When opening the contact".</p>	
At the end of the disabling function	no reaction Transmit current state ON OFF TOGGLE
<p>Besides disabling the channel, the device can immediately react at the end of the disabling.</p> <p>This parameter defines the reaction of the channel at the end of the disabling.</p> <p>i With "TOGGLE", the feedback of an actuator is to be connected with the "switching" object if the status object is not already made available by the settings of the parameter "When closing the contact" or "When opening the contact".</p>	

Object polarity	0 = enabled / 1 = disable 1 = enabled / 0 = disable
This parameter defines the value of the disabling object at which the disabling function is active.	

8.2.2.2 Object list

The following communication objects are available in the "switch" channel function with the parameterised "switching" function. The name can be adjusted with the "Name" parameter.

Object no.	Function	Name	Type	DPT	Flag
253, 261, ..., 277	Object 1 - Switching	K <i>n</i> - Output	1-bit	1,001	C, R, -, T, A

1-bit object for transmission of switching telegrams (ON, OFF). This is object 1 of the parameterised output objects.

i With "TOGGLE", the feedback of an actuator is to be connected with the "switching" object if the status object is not already made available by the settings of the parameter "When closing the contact" or "When opening the contact".

Object no.	Function	Name	Type	DPT	Flag
254, 262, ..., 278	Object 1 - Switching -Status	K <i>n</i> - Input	1-bit	1,001	C, -, W, -, U

1-bit object for receiving feedback telegrams (ON, OFF). This is object 1 of the parameterised output objects.

This object is visible if the "When closing the contact" or "When opening the contact" parameter is parameterised to "TOGGLE".

Object no.	Function	Name	Type	DPT	Flag
255, 263, ..., 279	Object 1 - Switching - Disabling	K <i>n</i> - Input	1-bit	1,003	C, -, W, -, U

1-bit object for activating or deactivating the disabling function. The object polarity can be parameterised. This is object 1 of the parameterised output objects.

Object no.	Function	Name	Type	DPT	Flag
257, 265, ..., 281	Object 2 - Switching	K <i>n</i> - Output	1-bit	1,001	C, R, -, T, A

1-bit object for transmission of switching telegrams (ON, OFF). This is object 2 of the parameterised output objects.

i With "TOGGLE", the feedback of an actuator is to be connected with the "switching" object if the status object is not already made available by the settings of the parameter "When closing the contact" or "When opening the contact".

Object no.	Function	Name	Type	DPT	Flag
258, 266, ..., 282	Object 2 - Switching -Status	K n - Input	1-bit	1,001	C, -, W, -, U
<p>1-bit object for receiving feedback telegrams (ON, OFF). This is object 2 of the parameterised output objects.</p> <p>This object is visible if the "When closing the contact" or "When opening the contact" parameter is parameterised to "TOGGLE".</p>					
Object no.	Function	Name	Type	DPT	Flag
259, 267, ..., 283	Object 2 - Switching - Disabling	K n - Input	1-bit	1,003	C, -, W, -, U
<p>1-bit object for activating or deactivating the disabling function. The object polarity can be parameterised. This is object 2 of the parameterised output objects.</p>					

8.2.3 Forced position

In the "switch" channel function, each object of the switch can be parameterised separately for the "forced position" function. The ETS indicates up to two communication objects for each switch channel output object for the "forced position" function. The parameters can be used to determine which value the "forced position" object receives when the contact is closed or opened. Furthermore, the behaviour of the switch channel output object after the bus voltage returns can be parameterised and a disabling function activated. The switching status of the switch channel output objects can be transmitted cyclically on the bus. No distinction is made between a brief or long press.

- i** A forced position can be used as a superordinate, prioritised function. A forced position is recommended for load management or in service mode.

8.2.3.1 Table of parameters

The following parameters are available in the "switch" channel function with the parameterised "forced position" function for each switch channel output object.

When closing the contact	no reaction Forcing active, ON Forcing active, OFF Forcing inactive
This parameter determines the reaction when closing the contact of the switch.	

When opening the contact	no reaction Forcing active, ON Forcing active, OFF Forcing inactive
This parameter determines the reaction when opening the contact of the switch.	
After bus voltage return	no reaction Transmit current state Forcing active, ON Forcing active, OFF Forcing inactive
<p>This parameter determines the reaction after the bus voltage returns.</p> <p>Either no telegram, a telegram according to the current input state at the channel, a forcing active ON telegram, a forcing active OFF telegram or a forcing inactive telegram is transmitted on the bus according to the parameterisation.</p> <p>The reaction after the bus voltage returns takes place only after the parameterised "delay after bus voltage returns" expires ("General" parameter page).</p>	
Send switching status cyclically	Inactive Active
<p>The switching status of the switch channel output objects can be transmitted cyclically on the bus.</p> <p>This parameter enables the cyclical transmission.</p>	
Cycle time	0...24 h 0...5...59 min 0...59 s
<p>This parameter defines the interval at which the switching status is transmitted on the bus.</p> <p>The cycle time can be parameterised between 3 seconds and 24 hours.</p>	
Disabling function	Inactive Active
This parameter enables the disabling function for the channel.	
At the beginning of the disabling function	no reaction Forcing active, ON Forcing active, OFF Forcing inactive
<p>Besides disabling the channel, the device can immediately react when the disabling occurs.</p> <p>This parameter defines the reaction of the channel at the beginning of the disabling.</p>	

At the end of the disabling function	no reaction Transmit current state Forcing active, ON Forcing active, OFF Forcing inactive
Besides disabling the channel, the device can immediately react at the end of the disabling. This parameter defines the reaction of the channel at the end of the disabling.	
Object polarity	0 = enabled / 1 = disable 1 = enabled / 0 = disable
This parameter defines the value of the disabling object at which the disabling function is active.	

8.2.3.2 Object list

The following communication objects are available in the "switch" channel function with the parameterised "forced position" function. The name can be adjusted with the "Name" parameter.

Object no.	Function	Name	Type	DPT	Flag
253, 261, ..., 277	Object 1 - Forced position	K <i>n</i> - Output	2-bit	2,001	C, R, -, T, A

2-bit input object for activating and deactivating the forced position. With the value "1", bit 1 of the telegram activates the forced position. The assigned channels are then locked in the state specified by bit 0 ("0" = OFF / "1" = ON). The value "0" in bit 1 deactivates the forced position again. This is object 1 of the parameterised output objects.

0x = forcing inactive

10 = forcing active, OFF

11 = forcing active, ON

Object no.	Function	Name	Type	DPT	Flag
255, 263, ..., 279	Object 1 - Forced position - Disabling	K <i>n</i> - Input	1-bit	1,003	C, -, W, -, U

1-bit object for activating or deactivating the disabling function. The object polarity can be parameterised. This is object 1 of the parameterised output objects.

Object no.	Function	Name	Type	DPT	Flag
257, 265, ..., 281	Object 2 - Forced position	K <i>n</i> - Output	2-bit	2,001	C, R, -, T, A

2-bit input object for activating and deactivating the forced position. With the value "1", bit 1 of the telegram activates the forced position. The assigned channels are then locked in the state specified by bit 0 ("0" = OFF / "1" = ON). The value "0" in bit 1 deactivates the forced position again. This is object 2 of the parameterised output objects.

0x = forcing inactive

10 = forcing active, OFF

11 = forcing active, ON

Object no.	Function	Name	Type	DPT	Flag
259, 267, ..., 283	Object 2 - Forced position - Disabling	K <i>n</i> - Input	1-bit	1,003	C, -, W, -, U

1-bit object for activating or deactivating the disabling function. The object polarity can be parameterised. This is object 2 of the parameterised output objects.

8.2.4 Value transmitter

In the "switch" channel function, each object of the switch can be parameterised separately for the "value transmitter" function. The ETS indicates up to six communication objects for each switch channel output object for the "value transmitter" function. The parameters can be used to determine which value the "value transmitter" objects receive when the contact is closed or opened.

Furthermore, the behaviour of the switch channel output object after the bus voltage returns can be parameterised and a disabling function activated. The value status of the switch channel output objects can be transmitted cyclically on the bus. No distinction is made between a brief or long press.

The "value transmitter" function is used by the device to transmit parameterised values on the bus when closing and opening the contact.

Value ranges

The value transmitter knows 13 different value ranges. The parameter "Data point type | Value range" determines the value range used by the value transmitter, depending on the application case:

Function	Function	Lower numerical limit	Upper numerical limit
1-byte value transmitter	0...100%	0%	100%
1-byte value transmitter	0...255	0	255
1-byte value transmitter	0...360°	0°	360°
1-byte value transmitter	0...255%	0%	255%
1-byte value transmitter	-128...127	-128	127
2-byte value transmitter	0...65535	0	65535
2-byte value transmitter	Colour temperature value	1000 K	10000 K
2-byte value transmitter	-32768...32767	-32768	32767
2-byte value transmitter	Temperature value	0°C	40°C
2-byte value transmitter	Brightness value	0 lux	1500 lux
6-byte value transmitter	Colour temperature value + brightness	1000 K 0%	10000 K 100%
3-byte value transmitter	RGB/HSV	#000000	#FFFFFF

Function	Function	Lower numerical limit	Upper numerical limit
6-byte value transmitter	Colour value RGBW/HSVW	#000000 + 0	#FFFFFF + 255

The value that can be transmitted on the bus when closing and/or opening the contact can be parameterised for each of these ranges.

8.2.4.1 Table of parameters

The following parameters are available in the "switch" channel function with the parameterised "value transmitter" function for each switch channel output object.

Data point type Value range	DPT 5.001 0 ... 100% DPT 5.010 0 ... 255 DPT 5.003 0 ... 360° DPT 5.004 0 ... 255% DPT 6.010 -128 ... 127 DPT 7.001 0 ... 65535 DPT 7.600 1000 ... 10000 K DPT 8.001 -32768 ... 32767 DPT 9.001 0 ... 40°C DPT 9.004 0 ... 1500 lux DPT 249.600 Colour temperature value + brightness RGB/HSV (RGB: DPT 232.600, HSV: DPT 5.003, DPT 5.001, DPT 5.001) Colour value RGBW/HSVW (RGBW: DPT 251.600, HSVW: DPT 5.003, DPT 5.001, DPT 5.001, DPT 5.001)
-------------------------------	--

The "value transmitter" function distinguishes between 1-byte, 2-byte 3-byte and 6-byte values.

The following parameters and their settings depend on the setting for this parameter.

When closing the contact	no reaction Transmit value
--------------------------	--------------------------------------

This parameter determines the reaction when closing the contact of the switch.
 Transmit value: The ETS displays a suitable input field where the value can be entered according to the set "data point type | value range".

When opening the contact	no reaction Transmit value
--------------------------	-------------------------------

This parameter determines the reaction when opening the contact of the switch.
 Transmit value: The ETS displays a suitable input field where the value can be entered according to the set "data point type | value range".

Value	0 ... 100%
-------	-------------------

This parameter determines the object value when closing or opening the contact.
 It is visible only if "data point type | value range = DPT 5.001 | 0 ... 100%".

Value	0 ... 255
This parameter determines the object value when closing or opening the contact. It is visible only if "data point type value range = DPT 5.010 0 ... 255".	
Value	0 ... 360°
This parameter determines the object value when closing or opening the contact. It is visible only if "data point type value range = DPT 5.003 0 ... 360°".	
Value	0 ... 255%
This parameter determines the object value when closing or opening the contact. It is visible only if "data point type value range = DPT 5.004 0 ... 255%".	
Value	-128...0 ... 127
This parameter determines the object value when closing or opening the contact. It is visible only if "data point type value range = DPT 6.010 -128 ... 127".	
Value	0 ... 65535
This parameter determines the object value when closing or opening the contact. It is visible only if "data point type value range = DPT 7.001 0 ... 65535".	
Colour temperature value	1000 ... 2700 ... 10000 K
This parameter determines the object value when closing or opening the contact. It is visible only if "data point type value range = DPT 7.600 1000 ... 10000 K".	
Value	-32768 ... 0 ... 32767
This parameter determines the object value when closing or opening the contact. It is visible only if "data point type value range = DPT 8.001 -32768 ... 32767".	
Temperature value	0 ... 20 ... 40°C
This parameter determines the object value when closing or opening the contact. It is visible only if "data point type value range = DPT 9.001 0 ... 40°C".	
Brightness value	0, 50 ... 300 ... 1500 lux
This parameter determines the object value when closing or opening the contact. It is visible only if "data point type value range = DPT 9.004 0 ... 1500 lux".	
Colour temperature value	1000 ... 2700 ... 10000 K
This parameter determines the object value when closing or opening the contact. It is visible only if "data point type value range = DPT 249.600 colour temperature value + brightness".	
Brightness value	0 ... 100%
This parameter determines the object value when closing or opening the contact. It is visible only if "data point type value range = DPT 249.600 colour temperature value + brightness".	

Adjustment duration in the actuator	0 ... 100 min, 0, 1 ... 59 s, 0 ... 900 ms
<p>This parameter determines the object value when closing or opening the contact. It is visible only if "data point type value range = DPT 249.600 colour temperature value + brightness".</p>	
Colour value	#000000 ... #FFFFFF
<p>This parameter determines the object values of the 3-byte value transmitter (or 6-byte value transmitter), brightness value (V), saturation (S) and colour hue (H) objects when closing or opening the contact.</p> <p>It is visible with "data point type value range = RGB/HSV with colour wheel sequence (RGB: DPT 232.600, HSV: DPT 5.003, DPT 5.001, DPT 5.001)", "data point type value range = RGB/HSV with brightness adjustment (RGB: DPT 232.600, HSV: DPT 5.003, DPT 5.001, DPT 5.001)" and "data point type value range = colour value RGBW/HSVW (RGBW: DPT 251.600, HSVW: DPT 5.003, DPT 5.001, DPT 5.001, DPT 5.001)".</p> <p>The value (RGB/HSV) is configured by means of a colour picker.</p> <p>With the data point type value range "colour value RGBW/HSVW (RGBW: DPT 251.600, HSVW: DPT 5.003, DPT 5.001, DPT 5.001, DPT 5.001)", the white value is configured by means of a separate slider.</p>	
White value when pressed	0 ... 255
<p>This parameter determines the object value of the white value (W) object when closing or opening the contact.</p> <p>It is visible only if "data point type value range = colour value RGBW/HSVW (RGBW: DPT 251.600, HSVW: DPT 5.003, DPT 5.001, DPT 5.001, DPT 5.001)".</p>	
After bus voltage return	no reaction Transmit current state Transmit value
<p>This parameter determines the reaction after the bus voltage returns.</p> <p>Either no telegram, a telegram according to the current input state at the channel or a value parameterised accordingly for the set data point type value range is transmitted on the bus.</p> <p>The reaction after the bus voltage returns takes place only after the parameterised "delay after bus voltage returns" expires ("General" parameter page).</p>	
Value	0 ... 100%
<p>This parameter determines the object value after the bus voltage returns. It is visible only if "data point type value range = DPT 5.001 0 ... 100%".</p>	
Value	0 ... 255
<p>This parameter determines the object value after the bus voltage returns. It is visible only if "data point type value range = DPT 5.010 0 ... 255".</p>	

Value	0 ... 360°
This parameter determines the object value after the bus voltage returns. It is visible only if "data point type value range = DPT 5.003 0 ... 360°".	
Value	0 ... 255%
This parameter determines the object value after the bus voltage returns. It is visible only if "data point type value range = DPT 5.004 0 ... 255%".	
Value	-128...0 ... 127
This parameter determines the object value after the bus voltage returns. It is visible only if "data point type value range = DPT 6.010 -128 ... 127".	
Value	0 ... 65535
This parameter determines the object value after the bus voltage returns. It is visible only if "data point type value range = DPT 7.001 0 ... 65535".	
Colour temperature value	1000 ... 2700 ... 10000 K
This parameter determines the object value after the bus voltage returns. It is visible only if "data point type value range = DPT 7.600 1000 ... 10000 K".	
Value	-32768 ... 0 ... 32767
This parameter determines the object value after the bus voltage returns. It is visible only if "data point type value range = DPT 8.001 -32768 ... 32767".	
Temperature value	0 ... 20 ... 40°C
This parameter determines the object value after the bus voltage returns. It is visible only if "data point type value range = DPT 9.001 0 ... 40°C".	
Brightness value	0, 50 ... 300 ... 1500 lux
This parameter determines the object value after the bus voltage returns. It is visible only if "data point type value range = DPT 9.004 0 ... 1500 lux".	
Colour temperature value	1000 ... 2700 ... 10000 K
This parameter determines the object value after the bus voltage returns. It is visible only if "data point type value range = DPT 249.600 colour temperature value + brightness".	
Brightness value	0 ... 100%
This parameter determines the object value after the bus voltage returns. It is visible only if "data point type value range = DPT 249.600 colour temperature value + brightness".	

Adjustment duration in the actuator	0 ... 100 min, 0, 1 ... 59 s, 0 ... 900 ms
<p>This parameter determines the object value after the bus voltage returns.</p> <p>It is visible only if "data point type value range = DPT 249.600 colour temperature value + brightness".</p>	
Colour value	#000000 ... #FFFFFF
<p>This parameter determines the object values of the 3-byte value transmitter (or 6-byte value transmitter), brightness value (V), saturation (S) and colour hue (H) objects after the bus voltage returns.</p> <p>It is visible with "data point type value range = RGB/HSV with colour wheel sequence (RGB: DPT 232.600, HSV: DPT 5.003, DPT 5.001, DPT 5.001)", "data point type value range = RGB/HSV with brightness adjustment (RGB: DPT 232.600, HSV: DPT 5.003, DPT 5.001, DPT 5.001)" and "data point type value range = colour value RGBW/HSVW (RGBW: DPT 251.600, HSVW: DPT 5.003, DPT 5.001, DPT 5.001, DPT 5.001)".</p> <p>The value (RGB/HSV) is configured by means of a colour picker.</p> <p>With the data point type value range "colour value RGBW/HSVW (RGBW: DPT 251.600, HSVW: DPT 5.003, DPT 5.001, DPT 5.001, DPT 5.001)", the white value is configured by means of a separate slider.</p>	
White value	0 ... 255
<p>This parameter determines the object value of the white value (W) after the bus voltage returns.</p> <p>It is visible only if "data point type value range = colour value RGBW/HSVW (RGBW: DPT 251.600, HSVW: DPT 5.003, DPT 5.001, DPT 5.001, DPT 5.001)".</p>	
Transmit value cyclically	Inactive Active
<p>The value status of the switch channel output objects can be transmitted cyclically on the bus.</p> <p>This parameter enables the cyclical transmission.</p>	
Cycle time	0...24 h 0...5...59 min 0...59 s
<p>This parameter defines the interval at which the value status is transmitted on the bus.</p> <p>The cycle time can be parameterised between 3 seconds and 24 hours.</p>	
Disabling function	Inactive Active
<p>This parameter enables the disabling function for the channel.</p>	

At the beginning of the disabling function	no reaction Transmit value
Besides disabling the channel, the device can immediately react when the disabling occurs. This parameter defines the reaction of the channel at the beginning of the disabling.	
Value	0 ... 100%
This parameter determines the object value at the beginning of the disabling. It is visible only if "data point type value range = DPT 5.001 0 ... 100%".	
Value	0 ... 255
This parameter determines the object value at the beginning of the disabling. It is visible only if "data point type value range = DPT 5.010 0 ... 255".	
Value	0 ... 360°
This parameter determines the object value at the beginning of the disabling. It is visible only if "data point type value range = DPT 5.003 0 ... 360°".	
Value	0 ... 255%
This parameter determines the object value at the beginning of the disabling. It is visible only if "data point type value range = DPT 5.004 0 ... 255%".	
Value	-128...0 ... 127
This parameter determines the object value at the beginning of the disabling. It is visible only if "data point type value range = DPT 6.010 -128 ... 127".	
Value	0 ... 65535
This parameter determines the object value at the beginning of the disabling. It is visible only if "data point type value range = DPT 7.001 0 ... 65535".	
Colour temperature value	1000 ... 2700 ... 10000 K
This parameter determines the object value at the beginning of the disabling. It is visible only if "data point type value range = DPT 7.600 1000 ... 10000 K".	
Value	-32768 ... 0 ... 32767
This parameter determines the object value at the beginning of the disabling. It is visible only if "data point type value range = DPT 8.001 -32768 ... 32767".	
Temperature value	0 ... 20 ... 40°C
This parameter determines the object value at the beginning of the disabling. It is visible only if "data point type value range = DPT 9.001 0 ... 40°C".	

Brightness value	0, 50 ... 300 ... 1500 lux
This parameter determines the object value at the beginning of the disabling. It is visible only if "data point type value range = DPT 9.004 0 ... 1500 lux".	
Colour temperature value	1000 ... 2700 ... 10000 K
This parameter determines the object value at the beginning of the disabling. It is visible only if "data point type value range = DPT 249.600 colour temperature value + brightness".	
Brightness value	0 ... 100%
This parameter determines the object value at the beginning of the disabling. It is visible only if "data point type value range = DPT 249.600 colour temperature value + brightness".	
Adjustment duration in the actuator	0 ... 100 min, 0, 1 ... 59 s, 0 ... 900 ms
This parameter determines the object value at the beginning of the disabling. It is visible only if "data point type value range = DPT 249.600 colour temperature value + brightness".	
Colour value	#000000 ... #FFFFFF
This parameter determines the object values of the 3-byte value transmitter (or 6-byte value transmitter), brightness value (V), saturation (S) and colour hue (H) objects at the beginning of the disabling. It is visible with "data point type value range = RGB/HSV with colour wheel sequence (RGB: DPT 232.600, HSV: DPT 5.003, DPT 5.001, DPT 5.001)", "data point type value range = RGB/HSV with brightness adjustment (RGB: DPT 232.600, HSV: DPT 5.003, DPT 5.001, DPT 5.001)" and "data point type value range = colour value RGBW/HSVW (RGBW: DPT 251.600, HSVW: DPT 5.003, DPT 5.001, DPT 5.001, DPT 5.001)". The value (RGB/HSV) is configured by means of a colour picker. With the data point type value range "colour value RGBW/HSVW (RGBW: DPT 251.600, HSVW: DPT 5.003, DPT 5.001, DPT 5.001, DPT 5.001)", the white value is configured by means of a separate slider.	
White value	0 ... 255
This parameter determines the object value of the white value (W) object at the beginning of the disabling. It is visible only if "data point type value range = colour value RGBW/HSVW (RGBW: DPT 251.600, HSVW: DPT 5.003, DPT 5.001, DPT 5.001, DPT 5.001)".	

At the end of the disabling function	no reaction Transmit current state Transmit value
Besides disabling the channel, the device can immediately react at the end of the disabling. This parameter defines the reaction of the channel at the end of the disabling.	
Value	0 ... 100%
This parameter determines the object value at the end of the disabling. It is visible only if "data point type value range = DPT 5.001 0 ... 100%".	
Value	0 ... 255
This parameter determines the object value at the end of the disabling. It is visible only if "data point type value range = DPT 5.010 0 ... 255".	
Value	0 ... 360°
This parameter determines the object value at the end of the disabling. It is visible only if "data point type value range = DPT 5.003 0 ... 360°".	
Value	0 ... 255%
This parameter determines the object value at the end of the disabling. It is visible only if "data point type value range = DPT 5.004 0 ... 255%".	
Value	-128...0 ... 127
This parameter determines the object value at the end of the disabling. It is visible only if "data point type value range = DPT 6.010 -128 ... 127".	
Value	0 ... 65535
This parameter determines the object value at the end of the disabling. It is visible only if "data point type value range = DPT 7.001 0 ... 65535".	
Colour temperature value	1000 ... 2700 ... 10000 K
This parameter determines the object value at the end of the disabling. It is visible only if "data point type value range = DPT 7.600 1000 ... 10000 K".	
Value	-32768 ... 0 ... 32767
This parameter determines the object value at the end of the disabling. It is visible only if "data point type value range = DPT 8.001 -32768 ... 32767".	
Temperature value	0 ... 20 ... 40°C
This parameter determines the object value at the end of the disabling. It is visible only if "data point type value range = DPT 9.001 0 ... 40°C".	

Brightness value	0, 50 ... 300 ... 1500 lux
This parameter determines the object value at the end of the disabling. It is visible only if "data point type value range = DPT 9.004 0 ... 1500 lux".	
Colour temperature value	1000 ... 2700 ... 10000 K
This parameter determines the object value at the end of the disabling. It is visible only if "data point type value range = DPT 249.600 colour temperature value + brightness".	
Brightness value	0 ... 100%
This parameter determines the object value at the end of the disabling. It is visible only if "data point type value range = DPT 249.600 colour temperature value + brightness".	
Adjustment duration in the actuator	0 ... 100 min, 0, 1 ... 59 s, 0 ... 900 ms
This parameter determines the object value at the end of the disabling. It is visible only if "data point type value range = DPT 249.600 colour temperature value + brightness".	
Colour value	#000000 ... #FFFFFF
This parameter determines the object values of the 3-byte value transmitter (or 6-byte value transmitter), brightness value (V), saturation (S) and colour hue (H) objects at the end of the disabling. It is visible with "data point type value range = RGB/HSV with colour wheel sequence (RGB: DPT 232.600, HSV: DPT 5.003, DPT 5.001, DPT 5.001)", "data point type value range = RGB/HSV with brightness adjustment (RGB: DPT 232.600, HSV: DPT 5.003, DPT 5.001, DPT 5.001)" and "data point type value range = colour value RGBW/HSVW (RGBW: DPT 251.600, HSVW: DPT 5.003, DPT 5.001, DPT 5.001, DPT 5.001)". The value (RGB/HSV) is configured by means of a colour picker. With the data point type value range "colour value RGBW/HSVW (RGBW: DPT 251.600, HSVW: DPT 5.003, DPT 5.001, DPT 5.001, DPT 5.001)", the white value is configured by means of a separate slider.	
White value	0 ... 255
This parameter determines the object value of the white value (W) object at the end of the disabling. It is visible only if "data point type value range = colour value RGBW/HSVW (RGBW: DPT 251.600, HSVW: DPT 5.003, DPT 5.001, DPT 5.001, DPT 5.001)".	
Object polarity	0 = enabled / 1 = disable 1 = enabled / 0 = disable
This parameter defines the value of the disabling object at which the disabling function is active.	

8.2.4.2 Object list

The following communication objects are available in the "switch" channel function with the parameterised "value transmitter" function. The name can be adjusted with the "Name" parameter.

Object no.	Function	Name	Type	DPT	Flag
397, 421, ..., 469	Object 1 - Value transmitter - 0...100%	K n - Output	1-byte	5,001	C, R, -, T, A
409, 433, ..., 481	Object 2 - Value transmitter - 0...100%				

1-byte object for the transmission of values from 0 to 100%. This is object 1 or 2 of the parameterised output objects.

i These objects are visible only if "data point type | value range = DPT 5.001 | 0 ... 100%".

Object no.	Function	Name	Type	DPT	Flag
397, 421, ..., 469	Object 1 - Value transmitter - 0...255	K n - Output	1-byte	5,010	C, R, -, T, A
409, 433, ..., 481	Object 2 - Value transmitter - 0...255				

1-byte object for the transmission of values from 0 to 255. This is object 1 or 2 of the parameterised output objects.

i These objects are visible only if "data point type | value range = DPT 5.010 | 0 ... 255".

Object no.	Function	Name	Type	DPT	Flag
397, 421, ..., 469	Object 1 - Value transmitter - 0...360	K n - Output	1-byte	5,003	C, R, -, T, A
409, 433, ..., 481	Object 2 - Value transmitter - 0...360				

1-byte object for the transmission of values from 0 to 360°. This is object 1 or 2 of the parameterised output objects.

i These objects are visible only if "data point type | value range = DPT 5.003 | 0 ... 360°".

Object no.	Function	Name	Type	DPT	Flag
397, 421, ..., 469	Object 1 - Value transmitter - 0...255%	K n - Output	1-byte	5,004	C, R, -, T, A
409, 433, ..., 481	Object 2 - Value transmitter - 0...255%				
<p>1-byte object for the transmission of values from 0 to 255%. This is object 1 or 2 of the parameterised output objects.</p> <p>i These objects are visible only if "data point type value range = DPT 5.004 0 ... 255%".</p>					

Object no.	Function	Name	Type	DPT	Flag
397, 421, ..., 469	Object 1 - Value transmitter - -128...127	K n - Output	1-byte	6,010	C, R, -, T, A
409, 433, ..., 481	Object 2 - Value transmitter - -128...127				
<p>1-byte object for the transmission of values from -128 to 127. This is object 1 or 2 of the parameterised output objects.</p> <p>i These objects are visible only if "data point type value range = DPT 6.010 -128 ... 127".</p>					

Object no.	Function	Name	Type	DPT	Flag
397, 421, ..., 469	Object 1 - Value transmitter - 0...65535	K n - Output	2-byte	7,001	C, R, -, T, A
409, 433, ..., 481	Object 2 - Value transmitter - 0...65535				
<p>2-byte object for the transmission of values from 0 to 65535. This is object 1 or 2 of the parameterised output objects.</p> <p>i These objects are visible only if "data point type value range = DPT 7.001 0 ... 65535".</p>					

Object no.	Function	Name	Type	DPT	Flag
397, 421, ..., 469	Object 1 - Value transmitter - Colour temperature value	K n - Output	2-byte	7,600	C, R, -, T, A
409, 433, ..., 481	Object 2 - Value transmitter - Colour temperature value				

2-byte object for transmitting colour temperatures from 1000 to 10000 Kelvin. This is object 1 or 2 of the parameterised output objects.

i These objects are visible only if "data point type | value range = DPT 7.600 | 1000 ... 10000 K".

Object no.	Function	Name	Type	DPT	Flag
397, 421, ..., 469	Object 1 - Value transmitter - -32768...32767	K n - Output	2-byte	8,001	C, R, -, T, A
409, 433, ..., 481	Object 2 - Value transmitter - -32768...32767				

2-byte object for the transmission of values from -32768 to 32767. This is object 1 or 2 of the parameterised output objects.

i These objects are visible only if "data point type | value range = DPT 8.001 | -32768 ... 32767".

Object no.	Function	Name	Type	DPT	Flag
397, 421, ..., 469	Object 1 - Value transmitter - Temperature value	K n - Output	2-byte	9,001	C, R, -, T, A
409, 433, ..., 481	Object 2 - Value transmitter - Temperature value				

2-byte object for transmitting temperature values from 0 to 40 °C. This is object 1 or 2 of the parameterised output objects.

i These objects are visible only if "data point type | value range = DPT 9.001 | 0 ... 40°C".

Object no.	Function	Name	Type	DPT	Flag
397, 421, ..., 469	Object 1 - Value transmitter - Brightness value	K n - Output	2-byte	9,004	C, R, -, T, A
409, 433, ..., 481	Object 2 - Value transmitter - Brightness value				
<p>2-byte object for the transmission of brightness values from 0 to 1500 lux. This is object 1 or 2 of the parameterised output objects.</p> <p>i These objects are visible only if "data point type value range = DPT 9.004 0 ... 1500 lux".</p>					

Object no.	Function	Name	Type	DPT	Flag
397, 421, ..., 469	Object 1 - Value transmitter - Colour temperature value and brightness value	K n - Output	6-byte	249,600	C, R, -, T, A
409, 433, ..., 481	Object 2 - Value transmitter - Colour temperature value and brightness value				
<p>6-byte object used to transmit a colour temperature value, a brightness value and the adjustment time in the actuator. The actuator sets the received values during the adjustment time. This is object 1 or 2 of the parameterised output objects.</p> <p>i These objects are visible only if "data point type value range = DPT 249.600 colour temperature value + brightness" applies.</p>					

Object no.	Function	Name	Type	DPT	Flag
397, 421, ..., 469	Object 1 - Value transmitter - RGB/HSV (colour wheel sequence)	K n - Output	3-byte	232,600	C, R, -, T, A
409, 433, ..., 481	Object 2 - Value transmitter - RGB/HSV (colour wheel sequence)				
<p>3-byte object for transmitting 3-byte colour information. This is object 1 or 2 of the parameterised output objects.</p> <p>i These objects are visible only if "data point type value range = RGB/HSV with colour wheel sequence (RGB: DPT 232.600, HSV: DPT 5.003, DPT 5.001, DPT 5.001)".</p>					

Object no.	Function	Name	Type	DPT	Flag
397, 421, ..., 469	Object 1 - Value transmitter - RGB/HSV (brightness adjustment)	K n - Output	3-byte	232,600	C, R, -, T, A
409, 433, ..., 481	Object 2 - Value transmitter - RGB/HSV (brightness adjustment)				
<p>3-byte object for transmitting 3-byte colour information. This is object 1 or 2 of the parameterised output objects.</p> <p>i These objects are visible only with data point type value range: RGB/HSV with brightness adjustment (RGB: DPT 232.600, HSV: DPT 5.003, DPT 5.001, DPT 5.001).</p>					

Object no.	Function	Name	Type	DPT	Flag
397, 421, ..., 469	Object 1 - Value transmitter - RGBW	K n - Output	6-byte	251,600	C, R, -, T, A
409, 433, ..., 481	Object 2 - Value transmitter - RGBW				
<p>6-byte object for transmitting 6-byte colour information. This is object 1 or 2 of the parameterised output objects.</p> <p>i These objects are visible only with data point type value range: colour value RGBW/HSVW (RGBW: DPT 251.600, HSVW: DPT 5.003, DPT 5.001, DPT 5.001, DPT 5.001).</p>					

Object no.	Function	Name	Type	DPT	Flag
398, 422, ..., 470	Object 1 - Value transmitter - Colour hue (H)	K n - Output	1-byte	5,003	C, R, -, T, A
410, 434, ..., 482	Object 2 - Value transmitter - Colour hue (H)				
<p>1-byte object for transmitting the colour hue. This is object 1 or 2 of the parameterised output objects.</p> <p>i These objects are visible only with data point type value range:</p> <ul style="list-style-type: none"> - RGB/HSV with colour wheel sequence (RGB: DPT 232.600, HSV: DPT 5.003, DPT 5.001, DPT 5.001) - RGB/HSV with brightness adjustment (RGB: DPT 232.600, HSV: DPT 5.003, DPT 5.001, DPT 5.001) - Colour value RGBW/HSVW (RGBW: DPT 251.600, HSVW: DPT 5.003, DPT 5.001, DPT 5.001, DPT 5.001) 					

Object no.	Function	Name	Type	DPT	Flag
399, 423, ..., 471	Object 1 - Value transmitter - Saturation (S)	K n - Output	1-byte	5,001	C, R, -, T, A
411, 435, ..., 483	Object 2 - Value transmitter - Saturation (S)				

1-byte object for transmitting the saturation. This is object 1 or 2 of the parameterised output objects.

- i** These objects are visible only with data point type | value range:
- RGB/HSV with colour wheel sequence (RGB: DPT 232.600, HSV: DPT 5.003, DPT 5.001, DPT 5.001)
 - RGB/HSV with brightness adjustment (RGB: DPT 232.600, HSV: DPT 5.003, DPT 5.001, DPT 5.001)
 - Colour value RGBW/HSVW (RGBW: DPT 251.600, HSVW: DPT 5.003, DPT 5.001, DPT 5.001, DPT 5.001)

Object no.	Function	Name	Type	DPT	Flag
400, 424, ..., 472	Object 1 - Value transmitter - brightness value (V)	K n - Output	1-byte	5,001	C, R, -, T, A
412, 436, ..., 484	Object 2 - Value transmitter - brightness value (V)				

1-byte object for transmitting the brightness value. This is object 1 or 2 of the parameterised output objects.

- i** These objects are visible only with data point type | value range:
- RGB/HSV with colour wheel sequence (RGB: DPT 232.600, HSV: DPT 5.003, DPT 5.001, DPT 5.001)
 - RGB/HSV with brightness adjustment (RGB: DPT 232.600, HSV: DPT 5.003, DPT 5.001, DPT 5.001)
 - Colour value RGBW/HSVW (RGBW: DPT 251.600, HSVW: DPT 5.003, DPT 5.001, DPT 5.001, DPT 5.001)

Object no.	Function	Name	Type	DPT	Flag
401, 425, ..., 473	Object 1 - Value transmitter - White value (W)	K n - Output	1-byte	5,001	C, R, -, T, A
413, 437, ..., 485	Object 2 - Value transmitter - White value (W)				
<p>1-byte object for transmitting the white level. This is object 1 or 2 of the parameterised output objects.</p> <p>i These objects are visible only with data point type value range: colour value RGBW/HSVW (RGBW: DPT 251.600, HSVW: DPT 5.003, DPT 5.001, DPT 5.001, DPT 5.001).</p>					

Object no.	Function	Name	Type	DPT	Flag
403, 427, ..., 475	Object 1 - Value transmitter - Brightness value (V) - Status	K n - Input	1-byte	5,001	C, -, W, -, U
415, 438, ..., 487	Object 2 - Value transmitter - Brightness value (V) - Status				
<p>1-byte object for receiving the brightness value. This is object 1 or 2 of the parameterised output objects.</p> <p>i These objects are only visible with the following configuration:</p> <ul style="list-style-type: none"> - Data point type value range: RGB/HSV with brightness adjustment (RGB: DPT 232.600, HSV: DPT 5.003, DPT 5.001, DPT 5.001) - "Start value" parameter = as value from brightness (V) status object 					

Object no.	Function	Name	Type	DPT	Flag
403, 427, ..., 475	Object 1 - Value transmitter - Colour hue (H) - Status	K n - Input	1-byte	5,003	C, -, W, -, U
415, 438, ..., 487	Object 2 - Value transmitter - Colour hue (H) - Status				
<p>1-byte object for receiving the colour hue. This is object 1 or 2 of the parameterised output objects.</p> <p>i These objects are only visible with the following configuration:</p> <ul style="list-style-type: none"> - Data point type value range: RGB/HSV with colour wheel sequence (RGB: DPT 232.600, HSV: DPT 5.003, DPT 5.001, DPT 5.001) - "Start value" parameter = as value from colour hue (H) status object 					

Object no.	Function	Name	Type	DPT	Flag
403, 427, ..., 475	Object 1 - Value transmitter - RGB - Status	K <i>n</i> - Input	3-byte	232,600	C, -, W, -, U
415, 438, ..., 487	Object 2 - Value transmitter - RGB - Status				
<p>3-byte object for receiving 3-byte colour information. This is object 1 or 2 of the parameterised output objects.</p> <p>i These objects are only visible with the following configuration:</p> <ul style="list-style-type: none"> - Parameter: data point type value range: RGB/HSV with brightness adjustment (RGB: DPT 232.600, HSV: DPT 5.003, DPT 5.001, DPT 5.001), RGB/HSV with colour wheel sequence (RGB: DPT 232.600, HSV: DPT 5.003, DPT 5.001, DPT 5.001). - "Start value" parameter = as value from RGB status object 					
Object no.	Function	Name	Type	DPT	Flag
408, 432, ..., 480	Object 1 - Value transmitter - Disabling	K <i>n</i> - Input	1-bit	1,003	C, -, W, -, U
420, 444, ..., 492	Object 2 - Value transmitter - Disabling				
<p>1-bit object for activating or deactivating the disabling function. The object polarity can be parameterised. This is object 1 or 2 of the parameterised output objects.</p>					

8.2.5 Scene extension

In the "switch" channel function, each object of the switch can be parameterised separately for the "scene extension" function. The ETS indicates up to two communication objects for each switch channel output object for the "scene extension" function. The parameters can be used to determine which value the "scene extension" object receives when the contact is closed and/or opened. Furthermore, the behaviour of the switch channel output object after the bus voltage returns can be parameterised and a disabling function activated. The switching status of the switch channel output objects can be transmitted cyclically on the bus. No distinction is made between a brief or long press.

In the scene extension function, the device either calls a parameterised scene number (1...64) or switches between two scenes when the contact is closed or opened. This makes it possible to recall scenes stored in other devices.

Setting options when closing or opening the contact:

- Recall scene: results in simply recalling the scene.

- Switch over scene: The input option for a second scene number (1...64) appears. The two entered scene numbers are switched to and from each time the contact is closed or opened.
- i** This function can be used to call up to four different scenes if the switch is switched four times (Close - Open - Close - Open) if "Switch over scenes" is parameterised for "When closing the contact" and "When opening the contact".

8.2.5.1 Table of parameters

The following parameters are available in the "switch" channel function with the parameterised "scene extension" function for each switch channel output object.

When closing the contact	Recall scene Switch over scene
<p>The functionality of the scene extension when closing the contact of the switch is set here.</p> <p>Recall scene: results in simply recalling the scene.</p> <p>Switch over scene: The input option for a second scene number (1...64) appears. The two entered scene numbers are switched to and from each time the contact is closed.</p> <p>i The device transmits a telegram with the respective scene number on the bus.</p>	
Scene number	1...64
<p>According to the KNX standard, objects with data type 18.001 "Scene Control" can call up to 64 scenes by their numbers. The scene number to be transmitted when closing the contact is defined here.</p> <p>The input of the scene number is available only if "When closing the contact = Call scene".</p>	
First scene number	1...64
<p>According to the KNX standard, objects with data type 18.001 "Scene Control" can call up to 64 scenes by their numbers. The scene number to be transmitted when closing the contact is defined here.</p> <p>The input of the first scene number is available only if "When closing the contact = Switch over scene".</p>	
Second scene number	1, 2 ... 64
<p>According to the KNX standard, objects with data type 18.001 "Scene Control" can call up to 64 scenes by their numbers. The scene number to be transmitted when closing the contact is defined here.</p> <p>The input of the second scene number is available only if "When closing the contact = Switch over scene".</p>	

When opening the contact	Recall scene Switch over scene
<p>The functionality of the scene extension when opening the contact of the switch is set here.</p> <p>Recall scene: results in simply recalling the scene.</p> <p>Switch over scene: The input option for a second scene number (1...64) appears. The two entered scene numbers are switched to and from each time the contact is opened.</p> <p>i The device transmits a telegram with the respective scene number on the bus.</p>	
Scene number	1...64
<p>According to the KNX standard, objects with data type 18.001 "Scene Control" can call up to 64 scenes by their numbers. The scene number to be transmitted when opening the contact is defined here.</p> <p>The input of the scene number is available only if "When closing the contact = Call scene".</p>	
First scene number	1...64
<p>According to the KNX standard, objects with data type 18.001 "Scene Control" can call up to 64 scenes by their numbers. The scene number to be transmitted when opening the contact is defined here.</p> <p>The input of the first scene number is available only if "When closing the contact = Switch over scene".</p>	
Second scene number	1, 2 ... 64
<p>According to the KNX standard, objects with data type 18.001 "Scene Control" can call up to 64 scenes by their numbers. The scene number to be transmitted when opening the contact is defined here.</p> <p>The input of the second scene number is available only if "When closing the contact = Switch over scene".</p>	
After bus voltage return	no reaction Transmit current state Recall scene
<p>This parameter determines the reaction after the bus voltage returns.</p> <p>Either no telegram, a telegram according to the current input state at the channel or a parameterised scene number is transmitted on the bus according to the parameterisation.</p> <p>The reaction after the bus voltage returns takes place only after the parameterised "delay after bus voltage returns" expires ("General" parameter page).</p>	

Scene number	1...64
The parameter defines here the scene number to be transmitted after the bus voltage returns.	
Disabling function	Inactive Active
This parameter enables the disabling function for the channel.	
At the beginning of the disabling function	no reaction Recall scene
Besides disabling the channel, the device can immediately react when the disabling occurs. This parameter defines the reaction of the channel at the beginning of the disabling.	
Scene number	1...64
The scene number to be transmitted at the beginning of the disabling is defined here.	
At the end of the disabling function	no reaction Transmit current state Recall scene
Besides disabling the channel, the device can immediately react at the end of the disabling. This parameter defines the reaction of the channel at the end of the disabling.	
Scene number	1...64
The scene number to be transmitted at the end of the disabling is defined here.	
Object polarity	0 = enabled / 1 = disable 1 = enabled / 0 = disable
This parameter defines the value of the disabling object at which the disabling function is active.	

8.2.5.2 Object list

The following communication objects are available in the "switch" channel function with the parameterised "scene extension" function. The name can be adjusted with the "Name" parameter.

Object no.	Function	Name	Type	DPT	Flag
590, 598, ..., 614	Object 1 - Scene extension - Scene number	K <i>n</i> - Output	1-byte	18,001	C, R, -, T, A

1-byte object for recalling, switching over or storing one of a maximum of 64 scenes at a scene push-button sensor. This is object 1 of the parameterised output objects.

Object no.	Function	Name	Type	DPT	Flag
591, 599, ..., 615	Object 1 - Scene extension - Disabling	K <i>n</i> - Input	1-bit	1,003	C, -, W, -, U

1-bit object for activating or deactivating the disabling function. The object polarity can be parameterised. This is object 1 of the parameterised output objects.

Object no.	Function	Name	Type	DPT	Flag
594, 602, ..., 618	Object 2 - Scene extension - Scene number	K <i>n</i> - Output	1-byte	18,001	C, R, -, T, A

1-byte object for recalling, switching over or storing one of a maximum of 64 scenes at a scene push-button sensor. This is object 2 of the parameterised output objects.

Object no.	Function	Name	Type	DPT	Flag
595, 603, ..., 619	Object 2 - Scene extension - Disabling	K <i>n</i> - Input	1-bit	1,003	C, -, W, -, U

1-bit object for activating or deactivating the disabling function. The object polarity can be parameterised. This is object 2 of the parameterised output objects.

8.2.6 Room temperature control point

In the "switch" channel function, each object of the switch can be parameterised separately for the "room temperature control point" function. The ETS indicates up to three communication objects for each switch channel output object for the "room temperature control point" function. The parameters can be used to determine which values the "RTC control point" objects receive when the contact is closed or opened. Furthermore, the behaviour of the switch channel output object after the bus voltage returns can be parameterised and a disabling function activated. The RTC status of the switch channel output objects can be transmitted cyclically on the bus. No distinction is made between a brief or long press.

The "room temperature control point" channel function can be used to actuate a KNX room temperature controller.

The room temperature control point itself is not involved in the temperature control process. It allows the user to operate the single-room regulation from different points in the room. The room temperature control point can also be used to control central heating control devices located, for example, in a sub-distribution unit.

Typical KNX room temperature controllers generally offer different ways of influencing the room temperature control:

- Operating mode switchover:
Switching between different modes of operation (e. g. "Comfort", "Night" ...) with different setpoint temperatures assigned to each mode by the controller.
- Presence function:
Signalling the presence of a person in a room. The signalling may also be combined with a configured switchover in the mode of operation.
- Target temperature shift:
Adjustment of the target temperature via a temperature offset (DPT 9.002) or via levels (DPT 6.010).

The room temperature control point is operated by the switch functions of the device. In this way, it is possible to completely control a room temperature controller by changing the operating mode, specifying the presence function or adjusting the target temperature shift.

8.2.6.1 Operating mode switchover

Switchover of the controller operating mode can be effected in accordance with the standard function block for room temperature controllers defined in the KNX handbook using two 1-byte communication objects. The operating mode can be switched over with the normal and with the forced objects. The objects "RTC control point - Operating mode" enable the following modes to be selected:

- Comfort
- Standby
- Night
- Frost/heat protection
- Switchover: comfort/standby
- Switchover: comfort/night
- Switchover: standby/night
- Switchover: comfort/standby/night

The communication object "RTC control point - Operating mode - Forcing" is of higher priority. It permits forced switching between the following modes of operation:

- Forcing inactive (auto)
- Comfort
- Standby
- Night
- Frost/heat protection

- Switchover: comfort/standby
- Switchover: comfort/night
- Switchover: standby/night
- Switchover: comfort/standby/night
- Toggle: forced inactive (auto) / comfort
- Toggle: forced inactive (auto) / standby
- Toggle: forced inactive (auto) / night
- Switchover: forced inactive (auto) / frost/heat protection

The operating mode transmitted on the bus when closing or opening the switch of the room temperature control point is defined by the parameters "When closing the contact" and "When opening the contact". It is possible that either one of the above modes is called up or two or three modes are switched between.

8.2.6.2 Presence function

All channels whose functionality is set to "presence function" have the two communication objects "RTC control point - Presence" and "RTC control point - Presence - Status". The parameters "When closing the contact" and "When opening the contact" determine the object value transmitted on the bus when closing or opening the contact.

8.2.6.3 Target temperature shift

Another function of the room temperature control point that is available is the target temperature shift. It makes use of either two 2-byte communication objects with datapoint type 9.002 or two 1-byte communication objects with datapoint type 6.010 (integer with sign).

This control point function allows the basic setpoint temperature to be shifted on a room temperature controller by closing or opening the contact. The control point is usually operated in the same way as the main control point. A switch output object parameterised as setpoint temperature shift reduces or increases the setpoint temperature shift value once each time the contact is closed or opened. The direction of the value adjustment is defined by the parameters "When closing the contact" and "When opening the contact".

Communication with main controller

To enable the device to shift the target temperature on a room temperature controller, the controller must have input and output objects for the target temperature shift. In this case, the output object of the controller must be connected to the input object of the room temperature control point, and the input object of the controller must be connected to the output object of the room temperature control point in each case via their own group address.

All objects are of the same datapoint type and have the same value range. A target temperature shift is interpreted by count values: a shift in positive direction is expressed by positive values, whereas a shift in negative direction is represented by negative object values. An object value of "0" means that no target temperature shift has been set.

The room temperature control points detect the current position of the setpoint adjustment by means of the object "RTC control point - Target temperature shift - Status" of the room temperature control point connected to the room temperature controller. Starting from the value of the communication object, the setpoint is adjusted in the configured direction each time a button is pressed on a room temperature control point. Each time the setpoint is adjusted, the new shift by means of the object "RTC control point - Target temperature shift" of the room temperature control point is sent to the room temperature regulator.

With the "by counter value" function, the individual levels are weighted by the controller itself.

This requires that the respective communication objects are connected to all room temperature control points and the controller. The feedback information from the controller enables the room temperature control point to continue the adjustment at any time at the right point.

8.2.6.4 Table of parameters

The following parameters are available in the "switch" channel function with the parameterised "room temperature control point" function for each switch channel output object.

Function	Operating mode switchover Forced oper. mode switchover Presence function Target temperature shift
A room temperature control point can optionally switch over (force) the operating mode with normal or high priority, change the presence status or change the current room temperature setpoint value. With regard to the setting of this parameter, the ETS shows further parameters.	
When closing the contact	Comfort Standby Night Frost/heat protection Switchover: comfort/standby Switchover: comfort/night Switchover: standby/night Switchover: comfort/standby/night
If the room temperature control point is intended to change over the operating mode of the room temperature controller with normal priority, the extension can either switch on a defined operating mode or switch between different operating modes when the contact is closed.	
When opening the contact	Comfort Standby Night Frost/heat protection Switchover: comfort/standby Switchover: comfort/night Switchover: standby/night Switchover: comfort/standby/night
If the room temperature control point is intended to change over the operating mode of the room temperature controller with normal priority, the extension can either switch on a defined operating mode or switch between different operating modes when the contact is opened.	

When closing the contact	Forcing inactive (auto) Comfort Standby Night Frost/heat protection Switchover: comfort/standby Switchover: comfort/night Switchover: standby/night Switchover: comfort/standby/night Toggle: forced inactive (auto) / comfort Toggle: forced inactive (auto) / standby Toggle: forced inactive (auto) / night Switchover: forced inactive (auto) / frost/heat protection
--------------------------	--

If the room temperature control point is intended to switch the operating mode of the room temperature controller with high priority, the extension can either enable the change-over with normal priority (auto), switch on a defined operating mode with high priority or switch between different operating modes when the contact is closed.

When opening the contact	Forcing inactive (auto) Comfort Standby Night Frost/heat protection Switchover: comfort/standby Switchover: comfort/night Switchover: standby/night Switchover: comfort/standby/night Toggle: forced inactive (auto) / comfort Toggle: forced inactive (auto) / standby Toggle: forced inactive (auto) / night Switchover: forced inactive (auto) / frost/heat protection
--------------------------	--

If the room temperature control point is intended to switch the operating mode of the room temperature controller with high priority, the extension can either enable the change-over with normal priority (auto), switch on a defined operating mode with high priority or switch between different operating modes when the contact is opened.

When closing the contact	Presence ON Presence OFF Presence TOGGLE
The room temperature control point can switch the presence state of the room temperature controller either on or off in a defined way or the extension can switch between both states ("Presence TOGGLE") when the contact is closed. This parameter is only visible if "Function = presence function".	
When opening the contact	Presence ON Presence OFF Presence TOGGLE
The room temperature control point can switch the presence state of the room temperature controller either on or off in a defined way or the extension can switch between both states ("Presence TOGGLE") when the contact is opened. This parameter is only visible if "Function = presence function".	
Target temperature shift	By relative temperature value By meter value
Depending on the setting of the "Target temperature shift" parameter, the shift takes place by means of the 2-byte communication object in accordance with KNX DPT 9.002 or KNX DPT 6.010. This parameter is visible only if "function = target temperature shift".	
When closing the contact	+2 K +1.5 K +1 K +0.5 K -0.5 K -1 K -1.5 K -2 K
The temperature difference is defined in Kelvin here by which the setpoint temperature will be shifted up or down when the contact is closed. To shift the target temperature value, the room temperature control point uses the two communication objects "RTC control point - Target temperature shift" and "RTC control point - Target temperature shift - Status". The communication object "RTC control point - Target temperature shift - Status" informs the room temperature control point about the current state of the room temperature controller. Based on this value and the parameter here, the room temperature control point calculates the new level value, which it sends to the room temperature controller via the communication object "RTC control point - Target temperature shift". This parameter is visible only if "Functionality = setpoint temperature shift" and "Setpoint temperature shift = by relative temperature value".	

When opening the contact	+2 K +1.5 K +1 K +0.5 K -0.5 K -1 K -1.5 K -2 K
--------------------------	---

The difference in temperature by which the setpoint temperature is shifted up or down when the contact is opened is defined in Kelvin here.

To shift the target temperature value, the room temperature control point uses the two communication objects "RTC control point - Target temperature shift" and "RTC control point - Target temperature shift - Status".

The communication object "RTC control point - Target temperature shift - Status" informs the room temperature control point about the current state of the room temperature controller. Based on this value and the parameter here, the room temperature control point calculates the new level value, which it sends to the room temperature controller via the communication object "RTC control point - Target temperature shift".

This parameter is visible only if "Functionality = setpoint temperature shift" and "Setpoint temperature shift = by relative temperature value".

When closing the contact	Increase setpoint temperature Reduce setpoint temperature
--------------------------	---

The direction of the target temperature shift is defined here at the room temperature control point.

To shift the target temperature value, the room temperature control point uses the two communication objects "RTC control point - Target temperature shift" and "RTC control point - Target temperature shift - Status".

The communication object "RTC control point - Target temperature shift - Status" informs the extension about the current state of the room temperature controller. Based on this value and the parameter here, the room temperature control point calculates the new level value, which it sends to the room temperature controller via the communication object "RTC control point - Target temperature shift".

This parameter is visible only if "function = target temperature shift" and "type of target temperature shift = above meter value".

When opening the contact	Increase setpoint temperature Reduce setpoint temperature
<p>The direction of the target temperature shift is defined here at the room temperature control point.</p> <p>To shift the target temperature value, the room temperature control point uses the two communication objects "RTC control point - Target temperature shift" and "RTC control point - Target temperature shift - Status".</p> <p>The communication object "RTC control point - Target temperature shift - Status" informs the extension about the current state of the room temperature controller. Based on this value and the parameter here, the room temperature control point calculates the new level value, which it sends to the room temperature controller via the communication object "RTC control point - Target temperature shift".</p> <p>This parameter is visible only if "function = target temperature shift" and "type of target temperature shift = above meter value".</p>	
After bus voltage return	no reaction Transmit current state Comfort Standby Night Frost/heat protection
<p>This parameter determines the reaction after the bus voltage returns.</p> <p>Either no telegram, a telegram according to the current input state at the channel, a comfort telegram, a standby telegram, a night telegram or a frost/heat protection telegram is transmitted on the bus according to the parameterisation.</p> <p>The reaction after the bus voltage returns takes place only after the parameterised "delay after bus voltage returns" expires ("General" parameter page).</p> <p>Visible only if "Functionality = operating mode change-over".</p>	

After bus voltage return	no reaction Transmit current state Forcing inactive (auto) Comfort Standby Night Frost/heat protection
--------------------------	---

This parameter determines the reaction after the bus voltage returns.

Either no telegram, a telegram according to the current input state at the channel, a forcing inactive (auto) telegram, a comfort telegram, a standby telegram, a night telegram or a frost/heat protection telegram is transmitted on the bus according to the parameterisation.

The reaction after the bus voltage returns takes place only after the parameterised "delay after bus voltage returns" expires ("General" parameter page).

Visible only if "Functionality = forced operating mode change-over".

After bus voltage return	no reaction Transmit current state Presence ON Presence OFF Presence TOGGLE
--------------------------	--

This parameter determines the reaction after the bus voltage returns.

Either no telegram, a telegram according to the current input state at the channel or a presence telegram is transmitted on the bus according to the parameterisation.

The reaction after the bus voltage returns takes place only after the parameterised "delay after bus voltage returns" expires ("General" parameter page).

This parameter is only visible if "Function = presence function".

After bus voltage return	no reaction +2 K +1.5 K +1 K +0.5 K -0.5 K -1 K -1.5 K -2 K
--------------------------	--

This parameter determines the reaction after the bus voltage returns.
 Either no telegram or a temperature value telegram is transmitted on the bus according to the parameterisation.
 The reaction after the bus voltage returns takes place only after the parameterised "delay after bus voltage returns" expires ("General" parameter page).
 This parameter is visible only if "Functionality = setpoint temperature shift" and "Setpoint temperature shift = by relative temperature value".

After bus voltage return	no reaction Increase setpoint temperature Reduce setpoint temperature
--------------------------	--

This parameter determines the reaction after the bus voltage returns.
 Either no telegram or a counting value telegram is transmitted on the bus according to the parameterisation.
 The reaction after the bus voltage returns takes place only after the parameterised "delay after bus voltage returns" expires ("General" parameter page).
 This parameter is visible only if "function = target temperature shift" and "type of target temperature shift = above meter value".

Send operating mode cyclically	Inactive Active
--------------------------------	---------------------------

The switching status of the switch channel output objects can be transmitted cyclically on the bus.
 This parameter enables the cyclical transmission.
 Visible only if "Functionality = operating mode change-over".

Send forced operation mode cyclically	Inactive Active
---------------------------------------	---------------------------

The switching status of the switch channel output objects can be transmitted cyclically on the bus.
 This parameter enables the cyclical transmission.
 Visible only if "Functionality = forced operating mode change-over".

Send presence status cyclically	Inactive Active
<p>The switching status of the switch channel output objects can be transmitted cyclically on the bus.</p> <p>This parameter enables the cyclical transmission.</p> <p>This parameter is only visible if "Function = presence function".</p>	
Send target temperature shift cyclically	Inactive Active
<p>The switching status of the switch channel output objects can be transmitted cyclically on the bus.</p> <p>This parameter enables the cyclical transmission.</p> <p>This parameter is visible only if "function = target temperature shift".</p>	
Cycle time	0...24 h 0...5...59 min 0...59 s
<p>This parameter defines the interval at which the switching status is transmitted on the bus.</p> <p>The cycle time can be parameterised between 3 seconds and 24 hours.</p>	
Disabling function	Inactive Active
<p>This parameter enables the disabling function for the channel.</p>	
At the beginning of the disabling function	no reaction Comfort Standby Night Frost/heat protection
<p>Besides disabling the channel, the device can immediately react when the disabling occurs.</p> <p>This parameter defines the reaction of the channel at the beginning of the disabling.</p> <p>Visible only if "Functionality = operating mode change-over".</p>	

At the beginning of the disabling function	no reaction Forcing inactive (auto) Comfort Standby Night Frost/heat protection
--	---

Besides disabling the channel, the device can immediately react when the disabling occurs.
 This parameter defines the reaction of the channel at the beginning of the disabling.
 Visible only if "Functionality = forced operating mode change-over".

At the beginning of the disabling function	no reaction Presence ON Presence OFF Presence TOGGLE
--	--

Besides disabling the channel, the device can immediately react when the disabling occurs.
 This parameter defines the reaction of the channel at the beginning of the disabling.
 This parameter is only visible if "Function = presence function".

At the beginning of the disabling function	no reaction +2 K +1.5 K +1 K +0.5 K -0.5 K -1 K -1.5 K -2 K
--	--

Besides disabling the channel, the device can immediately react when the disabling occurs.
 This parameter defines the reaction of the channel at the beginning of the disabling.
 This parameter is visible only if "Functionality = setpoint temperature shift" and "Setpoint temperature shift = by relative temperature value".

<p>At the beginning of the disabling function</p>	<p>no reaction Increase setpoint temperature Reduce setpoint temperature</p>
<p>Besides disabling the channel, the device can immediately react when the disabling occurs.</p> <p>This parameter defines the reaction of the channel at the beginning of the disabling.</p> <p>This parameter is visible only if "function = target temperature shift" and "type of target temperature shift = above meter value".</p>	
<p>At the end of the disabling function</p>	<p>no reaction Transmit current state Comfort Standby Night Frost/heat protection</p>
<p>Besides disabling the channel, the device can immediately react at the end of the disabling.</p> <p>This parameter defines the reaction of the channel at the end of the disabling.</p> <p>Visible only if "Functionality = operating mode change-over".</p>	
<p>At the end of the disabling function</p>	<p>no reaction Transmit current state Forcing inactive (auto) Comfort Standby Night Frost/heat protection</p>
<p>Besides disabling the channel, the device can immediately react at the end of the disabling.</p> <p>This parameter defines the reaction of the channel at the end of the disabling.</p> <p>Visible only if "Functionality = forced operating mode change-over".</p>	
<p>At the end of the disabling function</p>	<p>no reaction Transmit current state Presence ON Presence OFF Presence TOGGLE</p>
<p>Besides disabling the channel, the device can immediately react at the end of the disabling.</p> <p>This parameter defines the reaction of the channel at the end of the disabling.</p> <p>This parameter is only visible if "Function = presence function".</p>	

At the end of the disabling function	no reaction +2 K +1.5 K +1 K +0.5 K -0.5 K -1 K -1.5 K -2 K
Besides disabling the channel, the device can immediately react at the end of the disabling. This parameter defines the reaction of the channel at the end of the disabling. This parameter is visible only if "Functionality = setpoint temperature shift" and "Setpoint temperature shift = by relative temperature value".	
At the end of the disabling function	no reaction Increase setpoint temperature Reduce setpoint temperature
Besides disabling the channel, the device can immediately react at the end of the disabling. This parameter defines the reaction of the channel at the end of the disabling. This parameter is visible only if "function = target temperature shift" and "type of target temperature shift = above meter value".	
Object polarity	0 = enabled / 1 = disable 1 = enabled / 0 = disable
This parameter defines the value of the disabling object at which the disabling function is active.	

8.2.6.5 Object list

The following communication objects are available in the "switch" channel function with the parameterised "room temperature control point" function. The name can be adjusted with the "Name" parameter.

Object no.	Function	Name	Type	DPT	Flag
966, 980, ..., 1008	Object 1 - RTC control point - Operating mode	K n - Output	1-byte	20,102	C, R, -, T, A

1-byte object for switching a room temperature controller between the Comfort, Standby, Night and Frost/heat protection operating modes. This is object 1 of the parameterised output objects.

This object is only visible if "Function = operating mode switchover".

Object no.	Function	Name	Type	DPT	Flag
967, 981, ..., 1009	Object 1 - RTC control point - Operating mode - Status	K n - Input	1-byte	20,102	C, -, W, -, U

1-byte object for receiving the operating mode of a room temperature controller. This is object 1 of the parameterised output objects.

This object is only visible if "Function = operating mode switchover".

Object no.	Function	Name	Type	DPT	Flag
966, 980, ..., 1008	Object 1 - RTC control point - Operating mode - Forced	K n - Output	1-byte	20,102	C, R, -, T, A

1-byte object for switching a room temperature controller under forced control between the Automatic, Comfort, Standby, Night and Frost / heat protection operating modes. This is object 1 of the parameterised output objects.

This object is only visible if "Function = forced operating mode switchover".

Object no.	Function	Name	Type	DPT	Flag
967, 981, ..., 1009	Object 1 - RTC control point - Operating mode - Forcing - Status	K n - Input	1-byte	20,102	C, -, W, -, U

1-byte object for receiving the operating mode of a room temperature controller. This is object 1 of the parameterised output objects.

This object is only visible if "Function = forced operating mode switchover".

Object no.	Function	Name	Type	DPT	Flag
966, 980, ..., 1008	Object 1 - RTC control point - Presence	K <i>n</i> - Output	1-bit	1,018	C, R, -, T, A
<p>1-bit object for changing over the presence status of a room temperature controller. This is object 1 of the parameterised output objects.</p> <p>This object is only visible if "Function = presence function".</p>					
967, 981, ..., 1009	Object 1 - RTC control point - Presence - Status	K <i>n</i> - Input	1-bit	1,018	C, -, W, -, U
<p>1-bit object for receiving the presence status of a room temperature controller. This is object 1 of the parameterised output objects.</p> <p>This object is only visible if "Function = presence function".</p>					
966, 980, ..., 1008	Object 1 - RTC control point - Target temperature shift	K <i>n</i> - Output	2-byte	9,002	C, R, -, T, A
<p>2-byte object for specification of a target temperature shift in Kelvin. The value "0" means that no shift is active. Values can be specified between -670760 K and 670760 K. This is object 1 of the parameterised output objects.</p> <p>This object is visible only if "function = target temperature shift" and "type of target temperature shift = above relative temperature value".</p>					
967, 981, ..., 1009	Object 1 - RTC control point - Target temperature shift - Status	K <i>n</i> - Input	2-byte	9,002	C, -, W, -, U
<p>2-byte object for receiving the status of the current target temperature shift in Kelvin. This is object 1 of the parameterised output objects.</p> <p>This object is visible only if "function = target temperature shift" and "type of target temperature shift = above relative temperature value".</p>					
966, 980, ..., 1008	Object 1 - RTC control point - Target temperature shift	K <i>n</i> - Output	1-byte	6,010	C, R, -, T, A
<p>1-byte object for specification of a target temperature shift. The value "0" means that no shift is active. The value is depicted in a two's complement in the positive or negative direction. This is object 1 of the parameterised output objects.</p> <p>This object is visible only if "function = target temperature shift" and "type of target temperature shift = above meter value".</p>					

Object no.	Function	Name	Type	DPT	Flag
967, 981, ..., 1009	Object 1 - RTC control point - Target temperature shift - Status	K <i>n</i> - Input	1-byte	6,010	C, -, W, -, U
<p>1-byte object to receive the status of the current target temperature shift. This is object 1 of the parameterised output objects.</p> <p>This object is visible only if "function = target temperature shift" and "type of target temperature shift = above meter value".</p>					
968, 982, ..., 1010	Object 1 - RTC control panel - Disabling	K <i>n</i> - Input	1-bit	1,003	C, -, W, -, U
<p>1-bit object for activating or deactivating the disabling function. The object polarity can be parameterised. This is object 1 of the parameterised output objects.</p>					
973, 987, ..., 1015	Object 2 - RTC control point - Operating mode	K <i>n</i> - Output	1-byte	20,102	C, R, -, T, A
<p>1-byte object for switching a room temperature controller between the Comfort, Standby, Night and Frost/heat protection operating modes. This is object 2 of the parameterised output objects.</p> <p>This object is only visible if "Function = operating mode switchover".</p>					
974, 988, ..., 1016	Object 2 - RTC control point - Operating mode - Status	K <i>n</i> - Input	1-byte	20,102	C, -, W, -, U
<p>1-byte object for receiving the operating mode of a room temperature controller. This is object 2 of the parameterised output objects.</p> <p>This object is only visible if "Function = operating mode switchover".</p>					
973, 987, ..., 1015	Object 2 - RTC control point - Operating mode - Forced	K <i>n</i> - Output	1-byte	20,102	C, R, -, T, A
<p>1-byte object for switching a room temperature controller under forced control between the Automatic, Comfort, Standby, Night and Frost / heat protection operating modes. This is object 2 of the parameterised output objects.</p> <p>This object is only visible if "Function = forced operating mode switchover".</p>					

Object no.	Function	Name	Type	DPT	Flag
974, 988, ..., 1016	Object 2 - RTC control point - Operating mode - Forcing - Status	K n - Input	1-byte	20,102	C, -, W, -, U
<p>1-byte object for receiving the operating mode of a room temperature controller. This is object 2 of the parameterised output objects.</p> <p>This object is only visible if "Function = forced operating mode switchover".</p>					

Object no.	Function	Name	Type	DPT	Flag
973, 987, ..., 1015	Object 2 - RTC control point - Presence	K n - Output	1-bit	1,018	C, R, -, T, A
<p>1-bit object for changing over the presence status of a room temperature controller. This is object 2 of the parameterised output objects.</p> <p>This object is only visible if "Function = presence function".</p>					

Object no.	Function	Name	Type	DPT	Flag
974, 988, ..., 1016	Object 2 - RTC control point - Presence - Status	K n - Input	1-bit	1,018	C, -, W, -, U
<p>1-bit object for receiving the presence status of a room temperature controller. This is object 2 of the parameterised output objects.</p> <p>This object is only visible if "Function = presence function".</p>					

Object no.	Function	Name	Type	DPT	Flag
973, 987, ..., 1015	Object 2 - RTC control point - Target temperature shift	K n - Output	2-byte	9,002	C, R, -, T, A
<p>2-byte object for specification of a target temperature shift in Kelvin. The value "0" means that no shift is active. Values can be specified between -670760 K and 670760 K. This is object 2 of the parameterised output objects.</p> <p>This object is visible only if "function = target temperature shift" and "type of target temperature shift = above relative temperature value".</p>					

Object no.	Function	Name	Type	DPT	Flag
974, 988, ..., 1016	Object 2 - RTC control point - Target temperature shift - Status	K n - Input	2-byte	9,002	C, -, W, -, U
<p>2-byte object for receiving the status of the current target temperature shift in Kelvin. This is object 2 of the parameterised output objects.</p> <p>This object is visible only if "function = target temperature shift" and "type of target temperature shift = above relative temperature value".</p>					

Object no.	Function	Name	Type	DPT	Flag
973, 987, ..., 1015	Object 2 - RTC control point - Target temperature shift	K <i>n</i> - Output	1-byte	6,010	C, R, -, T, A
<p>1-byte object for specification of a target temperature shift. The value "0" means that no shift is active. The value is depicted in a two's complement in the positive or negative direction. This is object 2 of the parameterised output objects.</p> <p>This object is visible only if "function = target temperature shift" and "type of target temperature shift = above meter value".</p>					
Object no.	Function	Name	Type	DPT	Flag
974, 988, ..., 1016	Object 2 - RTC control point - Target temperature shift - Status	K <i>n</i> - Input	1-byte	6,010	C, -, W, -, U
<p>1-byte object to receive the status of the current target temperature shift. This is object 2 of the parameterised output objects.</p> <p>This object is visible only if "function = target temperature shift" and "type of target temperature shift = above meter value".</p>					
Object no.	Function	Name	Type	DPT	Flag
975, 989, ..., 1017	Object 2 - RTC control panel - Disabling	K <i>n</i> - Input	1-bit	1,003	C, -, W, -, U
<p>1-bit object for activating or deactivating the disabling function. The object polarity can be parameterised. This is object 2 of the parameterised output objects.</p>					

8.3 Output

The "output" channel function can be parameterised for each channel. An LED or an electronic relay can be connected to the output and actuated via the bus. The object polarity can be parameterised.

With the LED connected, the channel can implement different application cases in combination with the logic functions Applications.

8.3.1 Applications

This chapter describes a selection of implementable application cases of the "output" channel function.

The cases are implemented in combination with the available logic functions. The logic functions are enabled on the "General" parameter page and parameterised on separate parameter pages. The output is connected via group addresses by the communication objects with the logic functions.

- i** Any evaluation of a forced position object can be performed directly by means of the status of the actuator and visualised by means of the output of the push-button interface.

8.3.1.1 flashing

The "flashing" application case can visualise an alarm with the LED connected to the output.

As soon as the device receives a 1-bit KNX telegram for the initiation of an alarm by means of the communication object "Logic gate (Inverter) - Input 1", an LED connected to the channel LED can flash in the "output" channel function.

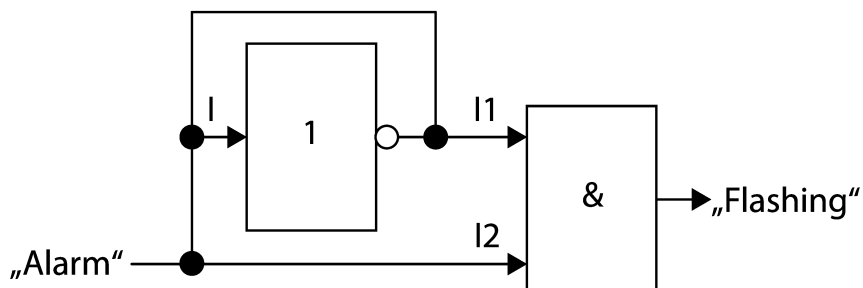

Figure 14: "Flashing" diagram

Example: parameterisation for "flashing" application case
Number of logic functions = 2
Channel function = output
Object polarity = 1 = ON / 0 = OFF
Type of logic function n = logic gate Selection: Logic gate = Invert (NOT)
Transmission criterion = always transmit when the inputs are updated
Delay for transmission of the result = 1 s
Type of logic function m = logic gate Selection: Logic gate = AND
Input 1 = input object, Invert input = inactive
Input 2 = input object, Invert input = inactive
Input 3 = deactivated
Input 4 = deactivated
Transmission criterion = transmit only if the output changes
Delay for transmission of the result = 0 s

For the implementation of the "flashing" application case, six communication objects are to be connected via three group addresses as illustrated in the "Flashing" diagram in the parameterisation example.

Example: connecting objects for "flashing" application case
Group address 1 Logic n - Input / logic gate (inverter) input 1 Logic m - Input / logic gate (AND) input 2
Group address 2 Logic n - Input / logic gate (inverter) input 1 Logic m - Input / logic gate (AND) input 1 Logic n - Output / Logic gate output
Group address 3 K n - Input / output - Switching Logic m - Output / Logic gate output

8.3.1.2 Timing functions

The "time functions" application case can be used to switch on the LED connected to the output after a delay, switch it off after a delay or switch it on and off after a delay.

Delayed switch-on

As soon as the device receives a 1-bit KNX telegram for the initiation of the delayed switch-on process by means of the "Disabling element input" communication object, an LED connected to the channel can flash after a delay in the "output" channel function.

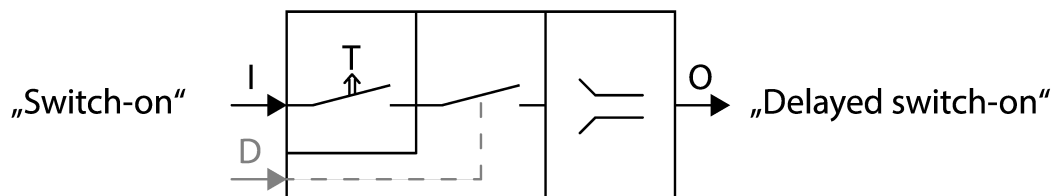

Figure 15: "Delayed switch-on" diagram

Example: parameterisation for "delayed switch-on" application case
Number of logic functions = 1
Channel function = output
Object polarity = 1 = ON / 0 = OFF
Type of logic function n = disabling element (filtering/time)
Time function = delay only ON telegrams
Delay for ON telegrams = 10 s
Disabling object polarity = 0 = enabled / 1 = disabled
Filter function = ON -> ON / OFF -> OFF
Transmission criterion = always transmit when the input is updated

For the implementation of the "delayed switch-on" application case, three communication objects are to be connected via two group addresses as illustrated in the "Delayed switch-on" diagram in the parameterisation example.

The communication object "Logic n - Input / Disabling element Disabling function" is not used in this application case.

Example: connecting objects for "delayed switch-on" application case
Group address 1 Logic n - Input / Disabling element input
Group address 2 K n - Input / output - Switching Logic n - Output / Disabling element output

i KNX telegrams used to switch off the output are processed without delay.

Delayed switch-off

As soon as the device receives a 1-bit KNX telegram for the initiation of the delayed switch-off process by means of the "Disabling element input" communication object, an LED connected to the channel can be switched off after a delay in the "output" channel function.

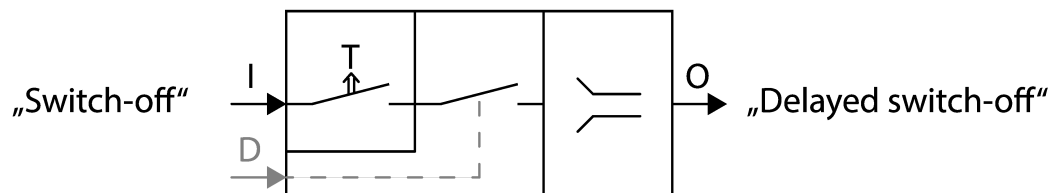

Figure 16: "Delayed switch-off" diagram

Example: parameterisation for "delayed switch-off" application case
Number of logic functions = 1
Channel function = output
Object polarity = 1 = ON / 0 = OFF
Type of logic function n = disabling element (filtering/time)
Time function = delay only OFF telegrams
Delay for OFF telegrams = 10 s
Disabling object polarity = 0 = enabled / 1 = disabled
Filter function = ON -> ON / OFF -> OFF
Transmission criterion = always transmit when the input is updated

For the implementation of the "delayed switch-off" application case, three communication objects are to be connected via two group addresses as illustrated in the "Delayed switch-off" diagram in the parameterisation example.

The communication object "Logic n - Input / Disabling element Disabling function" is not used in this application case.

Example: connecting objects for "delayed switch-off" application case
Group address 1 Logic n - Input / Disabling element input
Group address 2 K n - Input / output - Switching Logic n - Output / Disabling element output

i KNX telegrams used to switch on the output are processed without delay.

Delayed switch-on and switch-off

As soon as the device receives 1-bit KNX telegrams for the initiation of the delayed switch-off process by means of the "Disabling element input" communication object, an LED connected to the channel can be switched on and off after a delay in the "output" channel function.

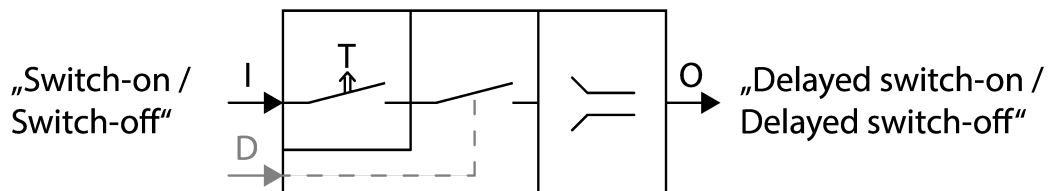

Figure 17: "Delayed switch-on and switch-off" diagram

Example: parameterisation for "delayed switch-on and switch-off" application case
Number of logic functions = 1
Channel function = output
Object polarity = 1 = ON / 0 = OFF
Type of logic function n = disabling element (filtering/time)
Time function = delay ON and OFF telegrams
Delay for ON telegrams = 5 s
Delay for OFF telegrams = 10 s
Disabling object polarity = 0 = enabled / 1 = disabled
Filter function = ON -> ON / OFF -> OFF
Transmission criterion = always transmit when the input is updated

For the implementation of the "delayed switch-on and switch-off" application case, three communication objects are to be connected via two group addresses as illustrated in the "Delayed switch-on and switch-off" diagram in the parameterisation example.

The communication object "Logic n - Input / Disabling element Disabling function" is not used in this application case.

Example: connecting objects for "delayed switch-on and switch-off" application case	
Group address 1	Logic n - Input / Disabling element input
Group address 2	K n - Input / output - Switching Logic n - Output / Disabling element output

Staircase function (delayed switch-off, triggerable)

As soon as the device receives a 1-bit KNX telegram for the initiation of the delayed switch-off process by means of the "Disabling element input" communication object, an LED connected to the channel can be switched off after a delay in the "output" channel function. The LED is switched off after a delay again if there are new KNX telegrams.

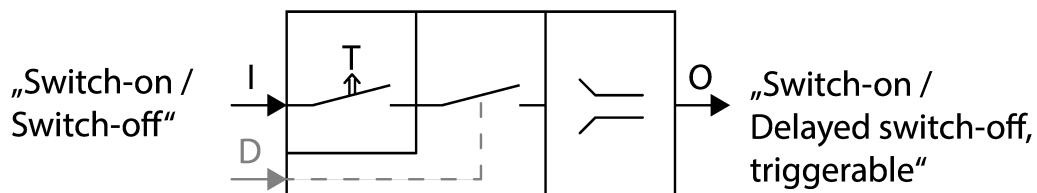

Figure 18: "Staircase function" diagram

Example: parameterisation for "staircase function" application case
Number of logic functions = 1
Channel function = output
Object polarity = 1 = ON / 0 = OFF
Type of logic function n = disabling element (filtering/time)
Time function = delay only OFF telegrams
Delay for OFF telegrams = 1 min
Disabling object polarity = 0 = enabled / 1 = disabled
Filter function = ON -> ON / OFF -> OFF
Transmission criterion = transmit only if the output changes

For the implementation of the "staircase function" application case, three communication objects are to be connected via two group addresses as illustrated in the "staircase function" diagram in the parameterisation example.

The communication object "Logic n - Input / Disabling element Disabling function" is not used in this application case.

Example: connecting objects for "staircase function" application case
Group address 1 Logic n - Input / Disabling element input
Group address 2 K n - Input / output - Switching Logic n - Output / Disabling element output

i KNX telegrams used to switch on the output are processed without delay.

8.3.1.3 Disabling function

The output can be disabled in the "disabling function" application case.

A channel at the "output" channel function can be disabled as soon as the device receives a 1-bit KNX telegram for the initiation of the disabling by means of the communication object "Disabling element Disabling function".

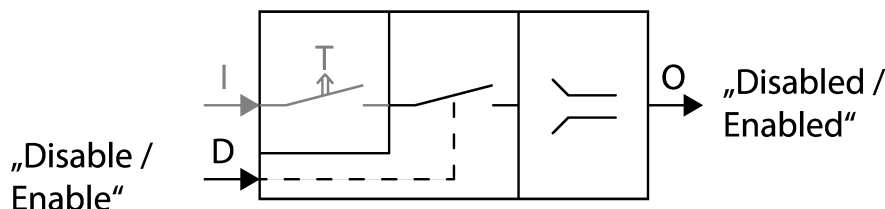

Figure 19: "Disabling function" diagram

Example: parameterisation for "disabling function" application case
Number of logic functions = 1
Channel function = output
Object polarity = 1 = ON / 0 = OFF
Type of logic function n = disabling element (filtering/time)
Time function = no delay
Filter function = ON -> ON / OFF -> OFF
Transmission criterion = always transmit when the input is updated

For the implementation of the "disabling function" application case, four communication objects are to be connected via three group addresses as illustrated in the "Disabling function" diagram in the parameterisation example.

Example: connecting objects for "disabling function" application case
Group address 1 Logic n - Input / Disabling element input
Group address 2 K n - Input / output - Switching Logic n - Output / Disabling element output
Group address 3 Logik n - Input / Disabling element Disabling function

8.3.1.4 Status indication reference value

In the "status indication reference value" application case, the LED connected to the output can light up depending on the value received. Different value telegrams can be received.

As soon as the device receives a value telegram for the initiation of the comparison-based switch-on and switch-off processes by means of the "comparator input" communication object, an LED connected to the channel can be switched on and off in the "output" channel function.

Example: parameterisation for "status indication references value" application case
Number of logic functions = 1
Channel function = output
Object polarity = 1 = ON / 0 = OFF
Type of logic function n = comparator
Data format = 1-byte value 0...255 (DPT 5.010)
Reference function = greater than or equal ($E \geq V$)
Reference value (V) = 150
Transmission criterion = transmit only if the output changes

For the implementation of the "status indication reference value" application case, three communication objects are to be connected via two group addresses as illustrated in the "Status indication reference value" diagram in the parameterisation example.

Example: connecting objects for "status indication references value" application case
Group address 1 Logic n - Input / Comparator input
Group address 2 K n - Input / output - Switching Logic n - Output / Comparator output

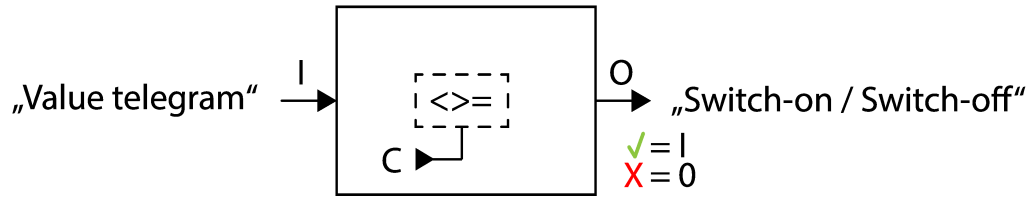

Figure 20: "Status indication reference value" diagram

i KNX telegrams used to switch off the output are processed without delay.

8.3.2 Table of parameters

The following parameter is available in the "output" channel function.

Object polarity	1 = ON / 0 = OFF 0 = ON / 1 = OFF
This parameter defines the value of the output object at which the channels is actuated.	

8.3.3 Object list

The following communication objects are available in the "output" channel function. The name can be adjusted with the "Name" parameter.

Object no.	Function	Name	Type	DPT	Flag
5, 10, ..., 20	Output - Switching	K <i>n</i> - Input	1-bit	1,001	C, -, W, -, U
1-bit object for receiving switching telegrams (ON, OFF). The output channel is actuated according to the parameterisation.					



Hager Controls S.A.S.

B.P. 10140

Saverne Cedex

France

T +33 (0) 3 88 02 87 00

info@hager.com

hager.com