

Hager Electro GmbH & Co. KG – Zum Gunterstal – 66440 Blieskastel – Germany
Solution Development & Marketing, Product Management Enclosures
Tel. +49 6842 945 0
www.hagergroup.net

Technical Product Documentation

Product / Product Range:

Empty Enclosures for Low-Voltage Switchgear and Controlgear Assemblies in accordance with IEC 62208

Rated operational voltage (U_e) **400 V** – Rated insulation voltage (U_i) **1,000 V** – Rated frequency (f_n) **50 Hz**

Designation:

1. Empty Outdoor Cabinets (KVS)
2. Empty Outdoor Pillars (ZAS)
3. Empty Outdoor Pillars (HAS)

Manufacturer:

Hager Electro GmbH & Co. KG
Zum Gunterstal
66440 Blieskastel
Germany

The results verify the requirements given by the above mentioned standard.

The results of test reports listed in this documentation are exclusively linked to the tested samples and compared or assessed variants.

This documentation shall not be reproduced except in full, without written approval.

Pascal Polster
SDM PM Enclosures

Date: 25/07/24 Ver. 1.1

List of Design Verifications

Characteristic to be verified	Clause or sub-clause	Verification by	Applicable document(s)	Verified product / range / series
Marking	9.3	Test	VAL230219436	ZAL10...P/V ZAL13...P/V ZAL17...P ZAL20...P ZAL142... ZAL162...
Static loads	9.4	Test	VAL230219436	
Lifting	9.5	N/A	-	
Mechanical Operation	9.6	Test	VAL230219436	
Axial loads of metal inserts	9.7	N/A	-	
Degree of protection against external mechanical impacts (IK code)	9.8	Test	VAL230219436	
Degree of protection against access to hazardous parts and against ingress of solid objects and/or water (IP code)	9.9	Test	VAL230219436	
Thermal stability	9.10.1	Test	VAL230219436	
Resistance to heat	9.10.2	Data sheet		
Resistance to abnormal heat and fire	9.10.3	Test	VAL230219436	
Dielectric strength	9.11	Test	VAL230219436	
Continuity of the protective circuit	9.12	N/A	-	

Resistance to ultra-violet (UV) radiation	9.13	Test	VAL230219436	
Resistance to corrosion	9.14	Test	HPB18040315 HPB20044415 HPB23014215	
Thermal power dissipation capability	9.15	Calculation	VAL230219436	

The test sequence described in table 1 of IEC 62208 was respected.

9.3 Marking

The wipe test was done in sequence with water and a solvent, and the marking was still legible afterwards.

9.4 Static Loads

The enclosures and their doors were tested with an evenly distributed weight of 1.25 times the permissible loads described in the corresponding product segments. The loads were retained for 1 h in a closed position at a temperature of 70 °C. During the test, the doors were opened five times through 90° resting at least 1 minute in the open position. The enclosures showed no cracks or permanent distortions. No mechanical characteristics were impaired during or after the test cycle.

9.5 Lifting

This clause is not applicable to the product range since there are no lifting devices for the enclosures.

9.6 Mechanical operation

After 200 mechanical cycles of the closing mechanism and the door, the protection degree of the enclosure was not affected. The force necessary for using the door did not change after the test.

9.7 Axial loads of metal inserts

In the ZAS and HAS range (Designations 2. and 3.), M6 threaded inserts are used in the backwall. These were tested with an axial load of 500 N. The inserts remained in their position, no movement could be witnessed. Furthermore, no cracks or splits appeared in the material containing the inserts.

9.8 Degree of protection against external mechanical impacts (IK code)

The verification of the protection degree against mechanical impacts (IK code) was carried out in accordance with IEC 62262. While the enclosure was fixed as in the normal use case, all exposed surfaces whose largest dimensions are less than or equal to 1 m were hit three times with the described hammer applying an impact energy of 20 J (IK10). All other surfaces whose largest dimensions exceed 1 m were hit 5 times accordingly. The impacts were evenly distributed over the face of the enclosure. The specimens passed since the degree of protection (IP code) was not impaired after the test. The dielectric properties maintained and the function of the doors and covers was not impacted.

9.9 Degree of protection against access to hazardous parts and against ingress of solid objects and/or water (IP code)

The listed enclosures were inspected in accordance with IEC 60529:1989, IEC 60529:1989/AMD1:1999, and IEC 60529:1989/AMD2:2013, sub-clauses 12.1, 12.2., 13.1, 13.2, 14.1, and 14.2. The value IPX4 is fulfilled by all assemblies since no water can enter the protected area inside the cabinets. The value IP4X is also fulfilled by all enclosures, except for the aeration area of the KVS range indicated in the respective sections (designations 1.) Here, we have a reduction to IP3XD between roof and back wall and between the door edges and the side walls (for details, see the respective sections on page 18). Thus, the standard requirements are fulfilled.

9.10 Properties of insulating materials

9.10.1 Thermal stability

The listed enclosures were tested in accordance with IEC 60068-2-2:2007, Test Bb, at a temperature of 70 °C, with natural air circulation, for a duration of 168 h and a recovery of 96 h. There appeared no cracks or other deteriorations on the housing surface.

9.10.2 Resistance to Heat

The ball pressure test according to EN 60695-10-2:2014 was passed for the insulating materials of the tested product ranges.

9.10.3 Resistance to abnormal heat and fire

All insulating materials used in the listed references were subjected to the glow-wire test according to IEC 60695-2-10/-11. All requirements were fulfilled. The temperature of the glow-wire tip was

- 960 °C for parts necessary to retain current-carrying parts in position (housing material)
- 650 °C for all other parts, including parts necessary to retain the protective conductor

9.11 Dielectric strength

After 48 h of preconditioning at 40 °C at a humidity level between 91 % and 95 % the value of 2,200 V was applied for a duration of 1 min between two metal foils, one in contact with the external surface and the other inside the enclosure at the limit of the protected space. The samples showed no damage, flashovers or breakdowns.

9.12 Continuity of the protective circuit

This test is not applicable to this product range.

9.13 Resistance to ultra-violet (UV) radiation

Specimens of the housing material of the listed enclosures were UV tested in accordance with ISO 4892-2:2013, method A, cycle 1 for an overall duration of 500 h. The samples fulfilled the requirements and retained their values of flexural strength (ISO 178) and Charpy impact (ISO 179) for at least 70 %.

KVS range (designation 1.) and ZAS range (designation 2.)

Test Criterion	Unit	Target	Value
before weathering			
Impact strength	KJ/m ²	--	47
Flexural modulus of elasticity	MPa	--	10,400
Flexural strength	MPa	--	136
Elongation at flexural strength	%	--	2.2
after weathering			
Impact strength	KJ/m ²	≥ 33	45
Flexural modulus of elasticity	MPa	≥ 7,280	10,000
Flexural strength	MPa	≥ 95	129
Elongation at flexural strength	%	≥ 1.5	2.2

HAS range (designation 3.)

Test Criterion	Unit	Target	Value
before weathering			
Impact strength	KJ/m ²	--	41
Flexural modulus of elasticity	MPa	--	10,500
Flexural strength	MPa	--	109
Elongation at flexural strength	%	--	1.6
after weathering			
Impact strength	KJ/m ²	≥ 29	35
Flexural modulus of elasticity	MPa	≥ 7,350	10,000
Flexural strength	MPa	≥ 76	122
Elongation at flexural strength	%	≥ 1.1	1.8

9.14 Resistance to corrosion

The ferrous metallic constructional parts of the listed assemblies were subjected to the damp heat cycling test of IEC 60028-2-30: Severity A – Temperature 55 °C, 6 cycles and variant 1. After the test, no unacceptable deteriorations were observed, in compliance with ISO 628-3:2016.

9.15 Thermal power dissipation capability

See the respective sections in the product segments.

1. Empty Outdoor Cabinets (KVS)

ZAL10xPV / ZAL13xPV



Overview of series Empty Outdoor Cabinets (KVS)

Cable Distribution Cabinets KVS (CDC)		
Size	1	2
Width in mm	780	1110
Height in mm	Depth: 315 mm	
1005		
Empty enclosure:	ZAL101	ZAL102
Empty enclosure w/ mounting plate:	ZAL101P	ZAL102P
Asymmetrical enclosure (2 doors):	ZAL101V	ZAL102V
1355		
Empty enclosure:	ZAL131	ZAL132
Empty enclosure w/ mounting plate:	ZAL131P	ZAL132P
Asymmetrical enclosure (2 doors):	--	ZAL132V

Reference table empty outdoor cabinets (KVS)

Reference	Description
ZAL101	Cable distribution cabinet, size 1, empty, single door, 1005 x 780 x 315 mm
ZAL101P	Cable distribution cabinet, size 1, w/ mounting plate, single door, 1005 x 780 x 315 mm
ZAL101V	Cable distribution cabinet, size 1, w/ mounting plate, asymmetric doors, 1005 x 780 mm x 315 mm
ZAL102	Cable distribution cabinet, size 2, empty, two-door, 1005 x 1100 x 315 mm
ZAL102P	Cable distribution cabinet, size 2, w/ mounting plate, two-door, 1005 x 1100 x 315 mm
ZAL102V	Cable distribution cabinet, size 2, w/ mounting plate, asymmetric doors, 1005 x 1100mm x 315 mm
ZAL131	Cable distribution cabinet, size 1, empty, single door, 1355 x 780 x 315 mm

ZAL131P	Cable distribution cabinet, size 1, with mounting plate, single door, 1355 x 780 x 315 mm
ZAL132	Cable distribution cabinet, size 2, empty, two-door, 1355 x 1100 x 315 mm
ZAL132P	Cable distribution cabinet, size 2, with mounting plate, two-door, 1355 x 1100 x 315 mm
ZAL132V	Cable distribution cabinet, size 2, w/ mounting plate, asymmetric doors, 1355 x 1100mm x 315 mm

Measurements in accordance with DIN 43629-1

Pedestals

		Empty Outdoor Enclosures (KVS)	
Size		1	2
Width in mm		780	1110
Height in mm		Depth: 315 mm	
Necessary Amount of ZAY95075:		3 bags	4 bags
Pedestal ZAX - Standard			
900			
		ZAX006	ZAX007
Pedestal ZAX - Wall Console			
640			
		ZAX012	ZAX013
Pedestal ZAX - On-ground pedestal			
250			
		ZAX015	ZAX016
Pedestal ZAX - Case for increasing the height			
225			
		ZAX021HAA	ZAX022HAA
Pedestal ZAX - Pedestal for flood-risk areas			
1125			
		ZAX031	ZAX032

Reference table Pedestals for Cable Distribution Cabinets

Reference	Description
ZAX006	Embedded pedestal, size 1, height: 900 mm
ZAX007	Embedded pedestal, size 2, height: 900 mm
ZAX012	Wall console, size 1, height: 640 mm
ZAX013	Wall console, size 2, height: 640 mm
ZAX015	Surface-mounted base, size 1, height: 250 mm
ZAX016	Surface-mounted base, size 2, height: 250 mm
ZAX021HAA	Frame for base elevation, CDC, for size 1, height: 225 mm
ZAX022HAA	Frame for base elevation, CDC, for size 2, height: 225 mm
ZAX031	Elevated embedded pedestal, size 1, height: 1125 mm
ZAX032	Elevated embedded pedestal, size 2, height: 1125 mm

Measurements in accordance with DIN 43629-2

General Characteristics

Technical Characteristic	Technical Value
Dimensional Standard	DIN 43629-1/-2/-3
Product Standards	IEC 62208:2023-06, EN 62208:2011
Classification according to IEC 62208	
Type of Material	Insulating
Method of Fixing	Floor standing (on-ground / in-ground) / wall mounting (wall console)
Intended Location	Outdoor
Degree of Protection (IP)	general: IP44 (IEC 60529) ventilation areas: IP34D (IEC 60529)
Protection against Mechanical Impact (IK)	IK10 (IEC 62262)
Rated Insulation Voltage U_i	1,000 V AC
Enclosure Material	
Material Type	Glass-fibre reinforced polyester (EN 14598-1 UP)
Colour	RAL 7035
Material Conformity	Low-Voltage Directive 2014/35/EU RoHS Directive 2011/65/EU + RoHS 2015/863/EU (Amendment) REACH Regulation EC 1907/2006
General Characteristics	
Surface Structure	Ribbed
Surface Treatment	Untreated
Protection Class	II
Permissible Loads	See chapter <i>Permissible Loads</i>
Environmental Conditions	
Ambient temperature min./max./24 h average	-25 °C / 40 °C / 35 °C Working temperatures for devices must be considered.
Humidity conditions	Relative humidity temporarily as high as 100 % at a max. temperature 25 °C
Pollution Degree	3
Electrical Characteristics	
Volume Resistivity	10 ¹⁴ Ohm cm (IEC 60093)
Dielectric Strength	4 kV (EN 60598-1) 14.5 kV (IEC 61439-1:2020)
Tracking Resistance	CTI 600 (IEC 60112)
Thermal Characteristics	
Glow-wire test	960 °C (IEC 60095-2-12)
Flammability	V0 4.0 mm (UL 94)
Heat Resistance	> 140 °C (IEC 62208 / IEC 60216) > 200 °C (ISO 75-2 A)
Chemical Characteristics	
Halogen content	Halogen free
UV and Corrosion Resistance	

UV resistance, mechanical	> 70 % retaining values of flexural strength (ISO 178) and Charpy impact (ISO 179)
Corrosion Resistance of Metal Parts	Damp heat cycling test (IEC 60028-2-30), Severity A, 55 °C, 6 cycles and variant 1
Further Requirements according to IEC 62208	
Axial Loads of Metal Inserts	Not applicable
Thermal Stability (9.9.1)	Dry heat IEC 60068-2-2 Test Bb / 70 °C
Resistance to Normal Heat (9.9.2)	IEC 60085
Resistance to Abnormal Heat and to Fire (9.9.3)	960 °C IEC 60695-2-10 / -11
Dielectric Strength (9.10)	1.5 times 2,200 VAC

Interface characteristics

In respect to IEC 62208

Characteristic	Value
Voltage Ratings	
Rated voltage U_n	400 V AC
Rated operational voltage U_e	400 V AC
Rated insulation voltage U_i	1,000 V AC
Rated impulse withstand voltage U_{imp}	up to 8 kV consider the values of the devices
Current Ratings	
Rated diversity factor RDF	none
Rated frequency f_n	50 Hz

Classification (IEC 62208:2023-06, cl. 4)

a) type of material:

insulating

b) method of fixing:

floor standing (necessary pedestal: in-ground socles and on-ground socles)

wall mounting (necessary pedestal: wall console)

c) intended location:

outdoor

d) degree of protection:

IP Code (IEC 60529): **IP44**, except defined ventilation areas: **IP34D**

IK Code (IEC 62262): **IK10**

e) rated insulation voltage:

1,000 VAC

Other characteristics (IEC 62208:2023-06, clause 6.3)

a) dimensions (see 6.3.2)

See product table on page 7ff.

b) mounting arrangements (see 6.3.3)

All enclosures are either empty or equipped with mounting plates. Empty enclosures have domes indicating the position for fastening a mounting plate. Mounting plates are made of PVC and 6 mm thick.

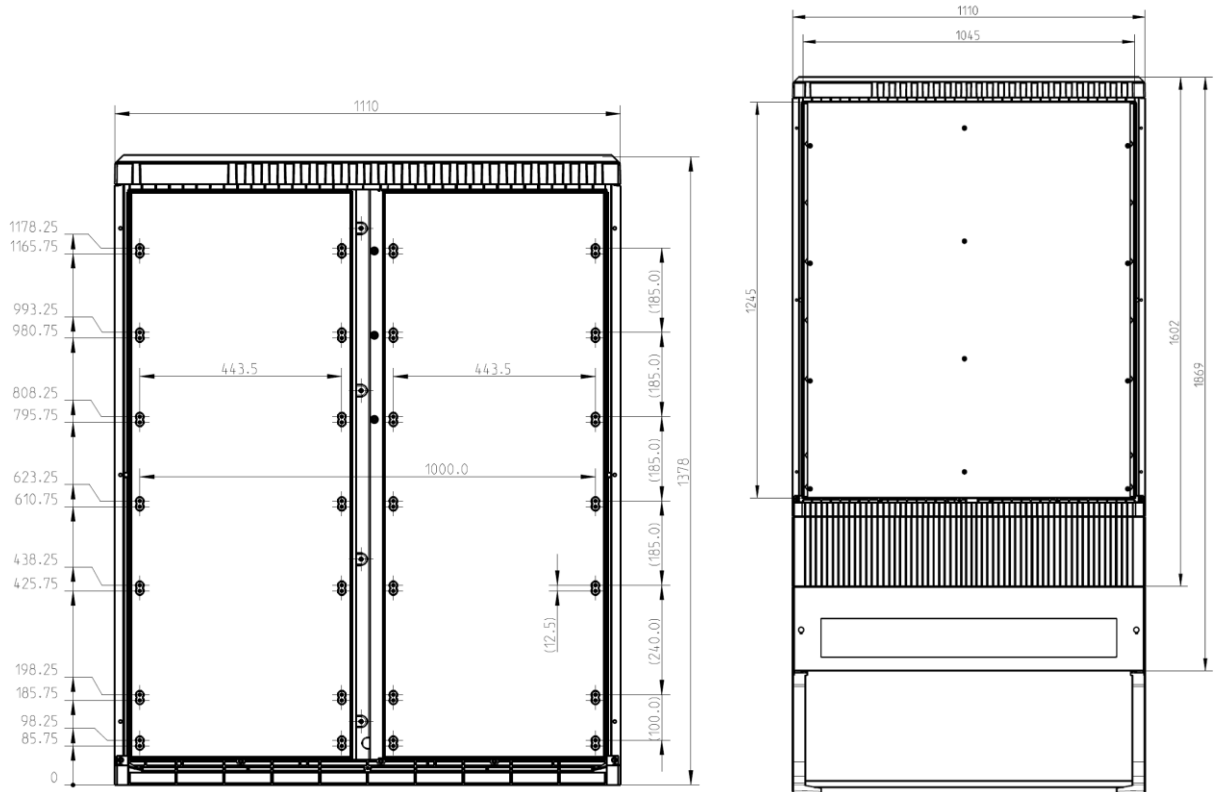

Left: Representative figure of an empty cabinet with the positioning of the domes for fastening the mounting plate. Right: Representative figure of an enclosure with the mounting plate inside.

The following table shows the dimensions of the mounting plates integrated in the corresponding cabinets.

Cabinet Product Reference	Mounting Plate Reference	Dimensions Mounting Plate H x W x D / mm x mm x mm
ZAL101P	ZAY76963	895 x 754 x 6
ZAL101V	9-76963 (not sold separately)	895 x 686 x 6
ZAL102P	ZAY76964	925 x 1,036 x 6
ZAL102V	9-76964 (not sold separately)	895 x 1,036 x 6
ZAL131P	ZAY76960	1,245 x 754 x 6
ZAL132P	ZAY76961	1,245 x 1,036 x 6
ZAL132V	9-76961 (not sold separately)	1,245 x 1,016 x 6

c) permissible loads (see 6.3.4)

Cabinet Product Reference	Permissible Load Mounting on backwall	Permissible Load Mounting on door
ZAL101 / ZAL101P / ZAL101V	50 kg	1 kg
ZAL102 / ZAL102P / ZAL102V	50 kg	1 kg
ZAL131 / ZAL131P / ZAL131V	50 kg	1 kg
ZAL132 / ZAL132P / ZAL132V	50 kg	1 kg

d) lifting and transport devices, if necessary (see 6.3.5)

The cabinets have no lugs to attach lifting devices. Transportation of the cabinet on pallet is recommended. Lifting on top of the pedestal has to be done manually by at least two persons wearing safety gloves and shoes.

e) protective measures (see 6.3.6)

Protection class II

f) thermal power dissipation capability (see 6.3.7)

see dedicated chapter on page 19f.

g) applicable service conditions (see cl. 7)

Ambient air temperature: - 25 °C to max. 40 °C (short-term) / 35 °C (average over a period of 24 hours)

Humidity conditions: 15 % to max. 100 % (at a temperature range of -25 °C to +27 °C) / 60 % (at temperature of 35 °C) / 46 % (at a temperature of 40 °C)

Moderate condensation can occur inside the cabinet due to shifts in temperature levels. The use of base filler material ZAY95075 is a prerogative to avoid excessive condensation and humidity ingress through the soil (in-ground application). The following table shows the necessary amount of ZAY95075 (25 l bag of base filler material).

Cabinet Product Reference	Necessary amount of ZAY95075
ZAL101 / ZAL101P / ZAL101V	3 bags
ZAL131 / ZAL131P / ZAL131V	
ZAL102 / ZAL102P / ZAL102V	4 bags
ZAL132 / ZAL132P / ZAL132V	

h) location and size of protected space

see dedicated chapter on page 17

i) rated insulation voltage U_i of enclosures constructed of an insulating material and Class II enclosures (see 9.11.3, Table 4)

1,000 V AC

j) degree of protection against mechanical impact (IK code, see 8.6)

IK10

k) degree of protection against contact with hazardous live parts, ingress of solid foreign bodies and water (IP code, see 8.7)

IP44 except defined ventilation areas (IP34D), see dedicated chapter on page 18

l) maximum permissible temperatures inside for which enclosures constructed of insulating material is suitable (see 9.10.2)

The temperature inside the enclosure shall never exceed 70 °C. The operating temperatures of the intended devices must be considered.

Definition of Protected Space and IP Protection

The protected space inside the cabinets begins at the inner top of the cabinet and reaches down as far as defined by height A in the table below. The width of the protected space is shown as parameter B in the table and is 48 mm away from the inner side walls on both sides of the cabinet. Parameter C shows the depth of the protected space beginning from the inner back wall of the cabinet.

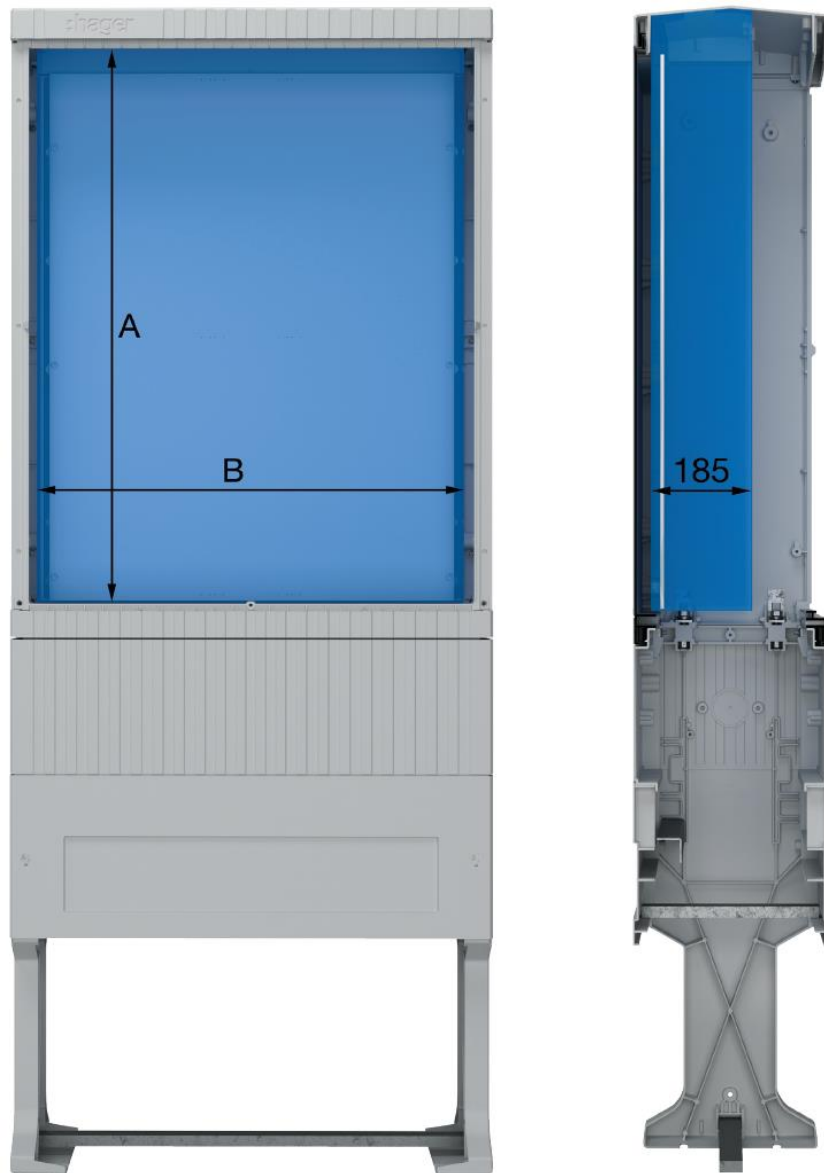

Cabinet Reference	A = Height / mm	B = Width /mm	C = Depth / mm
ZAL101*	790	750	185
ZAL102*	940	1,000	185
ZAL131*	1,240	750	185
ZAL132*	1,240	1,000	185

The cabinets have an IP protection of IP44 in accordance with IEC 60529 except in the defined ventilation areas shown below. In these areas, the protection is reduced to IP34D. This means, that still no water can reach the protected space since the second numeral of the code remains identical. The first numeral is reduced to 3 with the addition of the letter "D" at the end. This means, 1 mm wire cannot enter the cabinet to reach the protected space, but a spherical object that can run through the ventilation labyrinth might enter the enclosure.

Left: Ventilation area between back wall and roof; right: ventilation area at the edges of back wall and door to the side wall

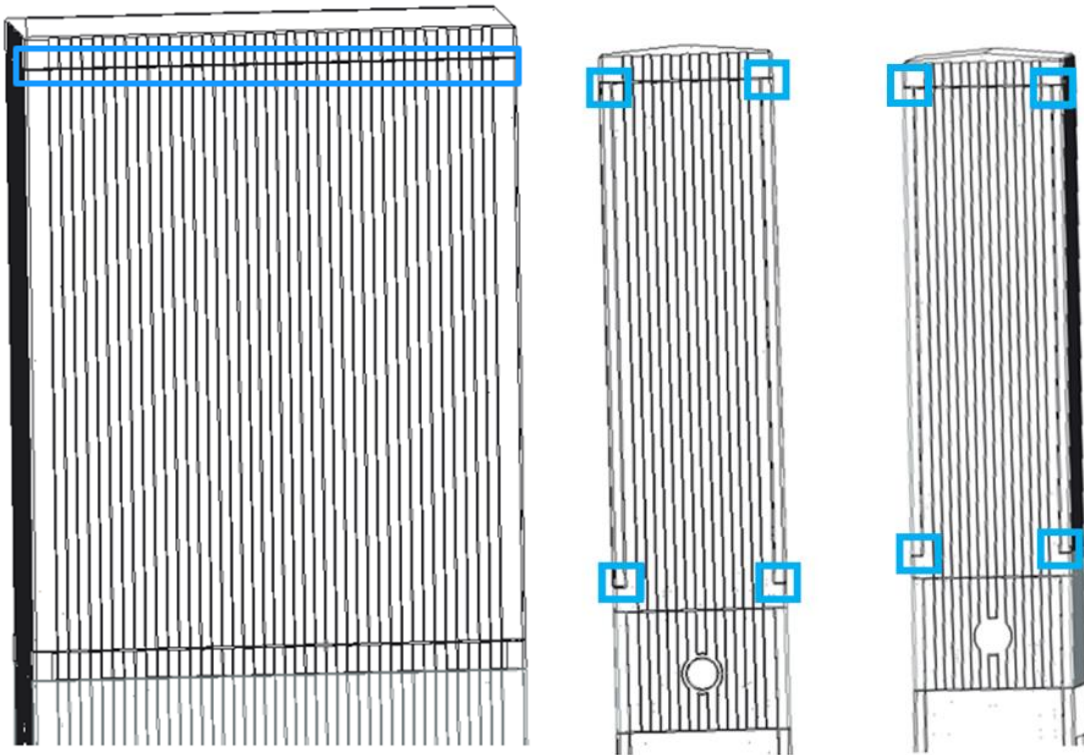

Thermal Power Dissipation

The overview of these values are shown in the table below, indicating the maximum power dissipation capability of the cabinet at a temperature increase of $\Delta T = 35 \text{ K}$ at an ambient temperature of $35 \text{ }^\circ\text{C}$, with the maximum temperature at 100 % cabinet height. This is therefore the worst-case value for the assembly.

Reference	Outer dimensions H x W x D / mm	$P_{\text{max}} /$ W	Weight / kg empty / asymmetric / mounting plate
ZAL101*	1,005 x 780 x 315	254	30 / 33 / 33
ZAL102*	1,005 x 1,110 x 315	375	39 / 54 / 48
ZAL131*	1,355 x 1,110 x 315	328	39 / -- / 45
ZAL132*	1,355 x 1,110 x 315	450	50 / 64 / 61

The verification of temperature-rise according to IEC 62208 can be achieved via calculation as described in sub-clause 9.15.4 in that standard. When designing the assembly, the temperature-rise limits must be respected. It falls to the assembly manufacturer to fulfil this verification when designing the assembly.

The following values are representative for the maximum power dissipation capability of the cabinets. Thus, the sum of all power dissipation values of all installed electrical equipment like cables, devices, meters, etc. must be smaller than the values below in the tables below. The installation situation, ambient temperature and the installed device with the lowest maximum operating temperature determine which value must be considered for the assembly.

Following, the tables show the calculated values for all cabinets in accordance with IEC 60890.

Key:

Location of temperature reference point:

t1,0: at 100 % height of the cabinet

t0,75: at 75% height of the cabinet

t0,5: at 50 % height of the cabinet

Type of installation:

FR: free standing enclosure

AP: wall mounting enclosure

ZAL101*

ΔT	t1,0		t0,75		t0,5	
	FR	AP	FR	AP	FR	AP
+5K	22 W	19 W	27 W	23 W	33 W	28 W
+10K	53 W	46 W	64 W	54 W	79 W	66 W
+15K	88 W	76 W	106 W	90 W	131 W	109 W
+20K	126 W	109 W	152 W	129 W	188 W	157 W
+25K	167 W	144 W	200 W	170 W	248 W	207 W
+30K	209 W	181 W	251 W	214 W	311 W	260 W
+35K	254 W	219 W	304 W	259 W	377 W	315 W

ZAL131*

ΔT	t1,0		t0,75		t0,5	
	FR	AP	FR	AP	FR	AP
+5K	29 W	24 W	36 W	30 W	46 W	38 W
+10K	69 W	59 W	85 W	72 W	109 W	90 W
+15K	114 W	98 W	141 W	119 W	181 W	150 W
+20K	163 W	140 W	201 W	170 W	259 W	215 W
+25K	216 W	184 W	266 W	225 W	343 W	284 W
+30K	271 W	232 W	334 W	282 W	430 W	356 W
+35K	328 W	281 W	405 W	342 W	521 W	431 W

ZAL102*

ΔT	t1,0		t0,75		t0,5	
	FR	AP	FR	AP	FR	AP
+5K	33 W	28 W	39 W	32 W	47 W	38 W
+10K	79 W	67 W	93 W	78 W	112 W	92 W
+15K	130 W	111 W	154 W	129 W	185 W	152 W
+20K	187 W	159 W	220 W	184 W	265 W	218 W
+25K	247 W	210 W	290 W	243 W	350 W	288 W
+30K	310 W	264 W	364 W	305 W	439 W	361 W
+35K	375 W	319 W	441 W	370 W	532 W	437 W

ZAL132*

ΔT	t1,0		t0,75		t0,5	
	FR	AP	FR	AP	FR	AP
+5K	40 W	36 W	48 W	43 W	59 W	52 W
+10K	94 W	86 W	114 W	102 W	141 W	124 W
+15K	157 W	143 W	188 W	169 W	234 W	206 W
+20K	224 W	204 W	269 W	242 W	335 W	295 W
+25K	296 W	270 W	356 W	320 W	442 W	389 W
+30K	371 W	338 W	447 W	401 W	555 W	489 W
+35K	450 W	410 W	541 W	486 W	672 W	592 W

2. Empty Outdoor Pillars (ZAS)

ZAL17xP / ZAL20xP

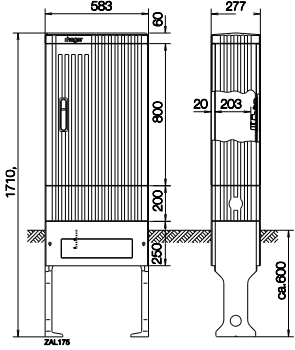
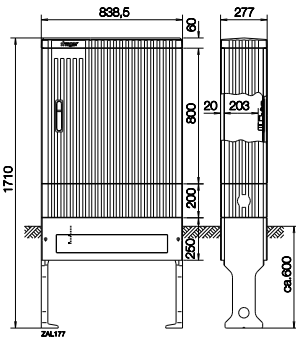
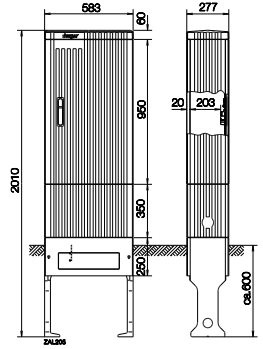
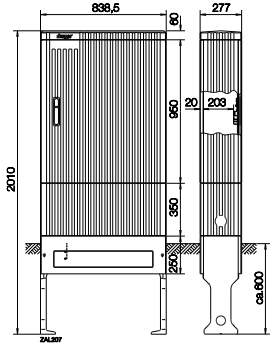

Overview of series Empty Outdoor Pillars (ZAS)

Distribution & Metering Pillars ZAS		
Size	5	7
Width in mm	583	839
Height in mm		
1710		
Empty enclosure:	ZAL175	ZAL177
Empty enclosure w/ mounting plate:	ZAL175P	ZAL177P
2010		
Empty enclosure:	ZAL205	ZAL207
Empty enclosure w/ mounting plate:	ZAL205P	ZAL207P
Necessary Amount of ZAY95075:	2 bags	3 bags

Reference table empty outdoor cabinets (KVS)

Reference	Description
ZAL175	Distribution Pillar, 175 series, empty, 1710 x 583 x 277 mm
ZAL175P	Distribution Pillar, 175 series, with mounting plate, 1710 x 583 x 277 mm
ZAL177	Distribution Pillar, 177 series, empty, 1710 x 838.5 x 277 mm
ZAL177P	Distribution Pillar, 177 series, with mounting plate, 1710 x 838.5 x 277 mm
ZAL205	Distribution Pillar, 205 series, empty, 2010 x 583 x 277 mm
ZAL205P	Distribution Pillar, 205 series, with mounting plate, 2010 x 583 x 277 mm
ZAL207	Distribution Pillar, 207 series, empty, 2010 x 838.5 x 277 mm
ZAL207P	Distribution Pillar, 207 series, with mounting plate, 2010 x 838.5 x 277 mm

General Characteristics

Technical Characteristic	Technical Value
Product Standards	IEC 62208:2023-06, EN 62208:2011
Classification according to IEC 62208	
Type of Material	Insulating
Method of Fixing	Floor standing (in-ground)
Intended Location	Outdoor
Degree of Protection (IP)	IP44 (IEC 60529)
Protection against Mechanical Impact (IK)	IK10 (IEC 62262)
Rated Insulation Voltage U_i	1,000 V AC
Enclosure Material	
Material Type	Glass-fibre reinforced polyester (EN 14598-1 UP)
Colour	RAL 7035
Material Conformity	Low-Voltage Directive 2014/35/EU RoHS Directive 2011/65/EU + RoHS 2015/863/EU (Amendment) REACH Regulation EC 1907/2006
General Characteristics	
Surface Structure	Ribbed
Surface Treatment	Untreated
Protection Class	II
Permissible Loads	See chapter <i>Permissible Loads</i>
Environmental Conditions	
Ambient temperature min./max./24 h average	-25 °C / 40 °C / 35 °C Working temperatures for devices must be considered.
Humidity conditions	Relative humidity temporarily as high as 100 % at a max. temperature 25 °C
Pollution Degree	3
Electrical Characteristics	
Volume Resistivity	10 ¹⁴ Ohm cm (IEC 60093)
Dielectric Strength	4 kV (EN 60598-1) 14.5 kV (IEC 61439-1:2020)
Tracking Resistance	CTI 600 (IEC 60112)
Thermal Characteristics	
Glow-wire test	960 °C (IEC 60095-2-12)
Flammability	V0 4.0 mm (UL 94)
Heat Resistance	> 140 °C (IEC 62208 / IEC 60216) > 200 °C (ISO 75-2 A)
Chemical Characteristics	
Halogen content	Halogen free
UV and Corrosion Resistance	
UV resistance, mechanical	> 70 % retaining values of flexural strength (ISO 178) and Charpy impact (ISO 179)
Corrosion Resistance of Metal Parts	Damp heat cycling test (IEC 60028-2-30), Severity A, 55 °C, 6 cycles and variant 1

Further Requirements according to IEC 62208	
Axial Loads of Metal Inserts	Compliant to section 9.6
Thermal Stability (9.9.1)	Dry heat IEC 60068-2-2 Test Bb / 70 °C
Resistance to Normal Heat (9.9.2)	IEC 60085
Resistance to Abnormal Heat and to Fire (9.9.3)	960 °C IEC 60695-2-10 / -11
Dielectric Strength (9.10)	1.5 times 2,200 VAC

Interface characteristics

In respect to IEC 62208

Characteristic	Value
Voltage Ratings	
Rated voltage U_n	400 V AC
Rated operational voltage U_e	400 V AC
Rated insulation voltage U_i	1,000 V AC
Rated impulse withstand voltage U_{imp}	up to 8 kV consider the values of the devices
Current Ratings	
Rated diversity factor RDF	none
Rated frequency f_n	50 Hz

Classification (IEC 62208:2023-06, cl. 4)

a) type of material:

insulating

b) method of fixing:

floor standing (in-ground mounting)

c) intended location:

outdoor

d) degree of protection:

IP Code (IEC 60529): **IP44**

IK Code (IEC 62262): **IK10**

e) rated insulation voltage:

1,000 VAC

Other characteristics (IEC 62208:2023-06, clause 6.3)

a) dimensions (see 6.3.2)

See product table on page 22

b) mounting arrangements (see 6.3.3)

All enclosures are either empty or equipped with mounting plates. Empty enclosures have perforated strips integrated in the backwall for inserting M6 insert nuts. Those are used for fastening a mounting plate. Mounting plates are made of PVC and 6 mm thick.

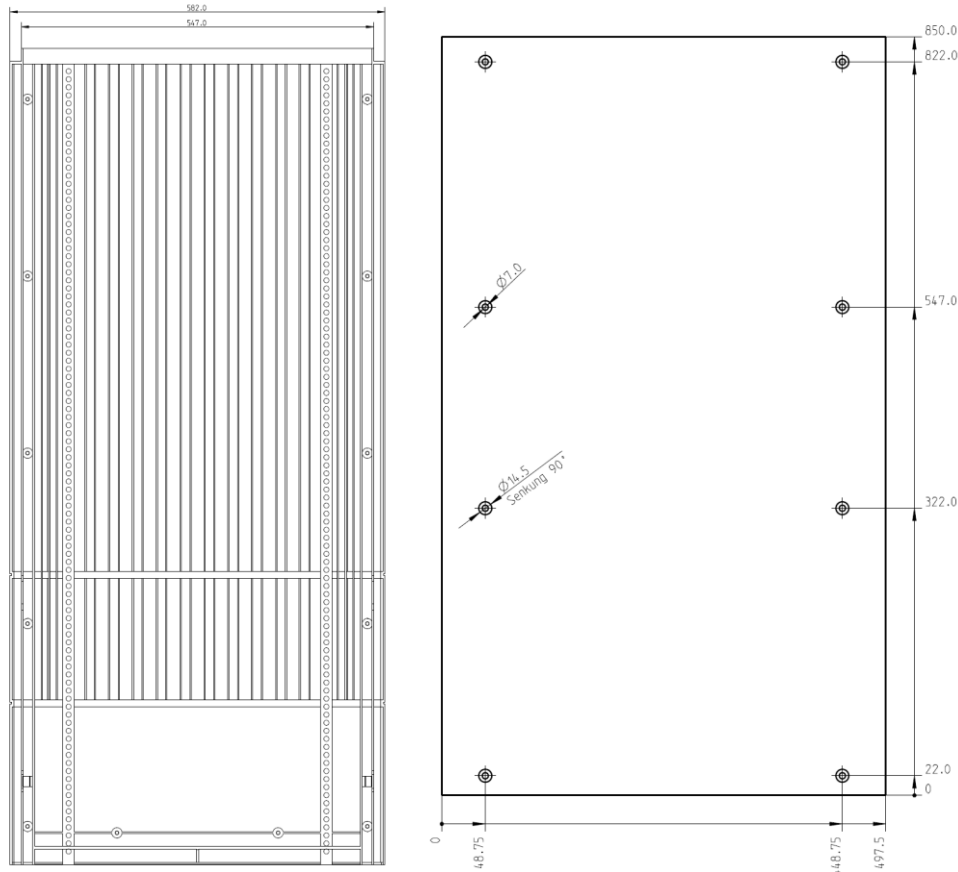

Left: Representative figure of a back wall of an empty cabinet with the perforated strip to mount the mounting plate. / Right: representative figure of a mounting plate.

The following table shows the dimensions of the mounting plates integrated in the corresponding cabinets.

Cabinet Product Reference	Mounting Plate Reference	Dimensions Mounting Plate H x W x D / mm x mm x mm
ZAL175P	ZAY47435M	850 x 497.5 x 6
ZAL177P	ZAY79270M	850 x 755.5 x 6
ZAL205P	ZAY47436M	997.5 x 497.5 x 6
ZAL207P	ZAY79268M	1,000 x 755.5 x 6

c) permissible loads (see 6.3.4)

Cabinet Product Reference	Permissible Load Mounting on backwall	Permissible Load Mounting on door
ZAL175 / ZAL175P	50 kg	1 kg
ZAL177 / ZAL177P	50 kg	1 kg
ZAL205 / ZAL205P	50 kg	1 kg
ZAL207 / ZAL207P	50 kg	1 kg

d) lifting and transport devices, if necessary (see 6.3.5)

The cabinets have no lugs to attach lifting devices. Transportation of the cabinet on pallet is recommended.

e) protective measures (see 6.3.6)

Protection class II

f) thermal power dissipation capability (see 6.3.7)

see dedicated chapter on page 30f.

g) applicable service conditions (see cl. 7)

Ambient air temperature: - 25 °C to max. 40 °C (short-term) / 35 °C (average over a period of 24 hours)

Humidity conditions: 15 % to max. 100 % (at a temperature range of -25 °C to +27 °C) / 60 % (at temperature of 35 °C) / 46 % (at a temperature of 40 °C)

Moderate condensation can occur inside the cabinet due to shifts in temperature levels. The use of base filler material ZAY95075 is a prerogative to avoid excessive condensation and humidity ingress through the soil (in-ground application). The following table shows the necessary amount of ZAY95075 (25 l bag of base filler material).

Cabinet Product Reference	Necessary amount of ZAY95075
ZAL175 / ZAL175P	2 bags
ZAL205 / ZAL205P	
ZAL177 / ZAL177P	3 bags
ZAL207 / ZAL207P	

h) location and size of protected space

see dedicated chapter on page 29

i) rated insulation voltage U_i of enclosures constructed of an insulating material and Class II enclosures (see 9.11.3, Table 4)

1,000 V AC

j) degree of protection against mechanical impact (IK code, see 8.6)

IK10

k) degree of protection against contact with hazardous live parts, ingress of solid foreign bodies and water (IP code, see 8.7)

IP44

l) maximum permissible temperatures inside for which enclosures constructed of insulating material is suitable (see 9.10.2)

The temperature inside the enclosure shall never exceed 70 °C. The operating temperatures of the intended devices must be considered.

Definition of Protected Space and IP Protection

The protected space inside the cabinets begins at the inner top of the cabinet and reaches down as far as defined by height A in the table below. The width of the protected space is shown as parameter B in the table and is 39 mm away from the inner side walls on both sides of the cabinet. Parameter C shows the depth of the protected space beginning from the inner back wall of the cabinet.

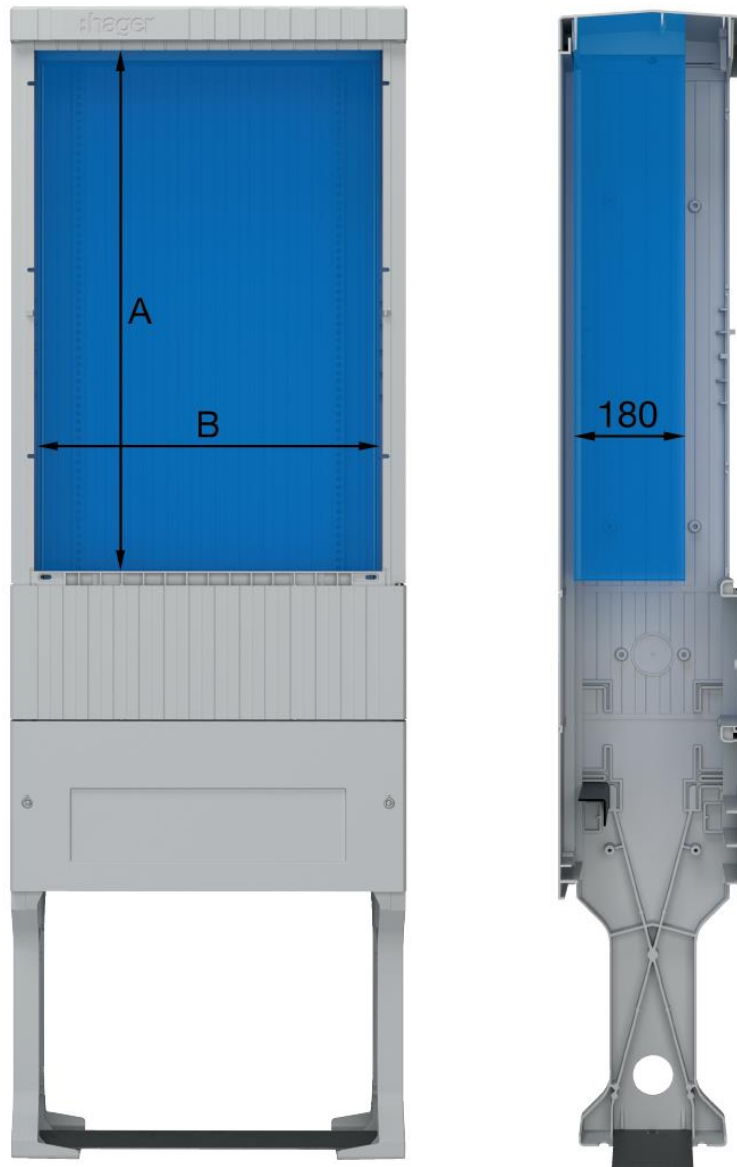

Cabinet Reference	A = Height / mm	B = Width /mm	C = Depth / mm
ZAL175*	800	500	180
ZAL177*	800	750	180
ZAL205*	1,100	500	180
ZAL207*	1,100	750	180

Thermal Power Dissipation

The overview of these values are shown in the table below, indicating the maximum power dissipation capability of the cabinet at a temperature increase of $\Delta T = 35 \text{ K}$ at an ambient temperature of $35 \text{ }^\circ\text{C}$, with the maximum temperature at 100 % cabinet height. This is therefore the worst-case value for the assembly.

Reference	Outer dimensions H x W x D / mm	$P_{\text{max}} /$ W	Weight / kg empty / w/ mounting plate
ZAL175*	1,710 x 583 x 277	185	25 / 29
ZAL177*	1,710 x 838.5 x 277	277	37 / 47
ZAL205*	2,010 x 583 x 277	229	32 / 36
ZAL207*	2,010 x 838.5 x 277	341	38 / 48

The verification of temperature-rise according to IEC 62208 can be achieved via calculation as described in sub-clause 9.15.4 in that standard. When designing the assembly, the temperature-rise limits must be respected. It falls to the assembly manufacturer to fulfil this verification when designing the assembly.

The following values are representative for the maximum power dissipation capability of the cabinets. Thus, the sum of all power dissipation values of all installed electrical equipment like cables, devices, meters, etc. must be smaller than the values below in the tables below. The installation situation, ambient temperature and the installed device with the lowest maximum operating temperature determine which value must be considered for the assembly.

Following, the tables show the calculated values for all cabinets in accordance with IEC 60890.

Key:

Location of temperature reference point:

t1,0: at 100 % height of the cabinet

t0,75: at 75% height of the cabinet

t0,5: at 50 % height of the cabinet

Type of installation:

FR: free standing enclosure

AP: wall mounting enclosure

ZAL175*

ΔT	t1,0	t0,75	t0,5
	FR	FR	FR
+5K	16 W	20 W	26 W
+10K	39 W	48 W	63 W
+15K	64 W	80 W	105 W
+20K	92 W	115 W	150 W
+25K	122 W	152 W	198 W
+30K	153 W	190 W	249 W
+35K	185 W	231 W	302 W

ZAL177*

ΔT	t1,0	t0,75	t0,5
	FR	FR	FR
+5K	24 W	29 W	37 W
+10K	58 W	71 W	89 W
+15K	96 W	117 W	147 W
+20K	138 W	168 W	211 W
+25K	182 W	221 W	279 W
+30K	229 W	278 W	350 W
+35K	277 W	337 W	424 W

ZAL205*

ΔT	t1,0	t0,75	t0,5
	FR	FR	FR
+5K	20 W	25 W	35 W
+10K	48 W	61 W	83 W
+15K	79 W	101 W	137 W
+20K	114 W	145 W	196 W
+25K	150 W	192 W	259 W
+30K	189 W	240 W	325 W
+35K	229 W	291 W	394 W

ZAL207*

ΔT	t1,0	t0,75	t0,5
	FR	FR	FR
+5K	30 W	37 W	49 W
+10K	71 W	89 W	116 W
+15K	118 W	147 W	192 W
+20K	170 W	211 W	275 W
+25K	224 W	279 W	363 W
+30K	281 W	350 W	455 W
+35K	341 W	423 W	551 W

3. Empty Outdoor Pillars (HAS)

ZAL142X / ZAL162X



Overview of series Empty Outdoor Pillars (HAS)

House Connection Pillars HAS	
Width in mm	320
Height in mm	Depth: 225 mm
1420	
Empty enclosure:	ZAL142
Empty enclosure w/ mounting plate:	ZAL142P
1595	
Empty enclosure:	ZAL162
Empty enclosure w/ mounting plate:	ZAL162P
Necessary Amount of ZAY95075:	1 bag

Reference table empty outdoor cabinets (KVS)

Reference	Description
ZAL142	Distribution Pillar, Series 142, empty, 1420 x 320 x 225 mm
ZAL142P	Distribution Pillar, Series 142, with mounting plate, 1420 x 320 x 225 mm
ZAL162	Distribution Pillar, Series 162, empty, 1595 x 320 x 225 mm
ZAL162P	Distribution Pillar, Series 162, with mounting plate, 1595 x 320 x 225 mm

General Characteristics

Technical Characteristic	Technical Value
Product Standards	IEC 62208:2023-06, EN 62208:2011
Classification according to IEC 62208	
Type of Material	Insulating
Method of Fixing	Floor standing (in-ground)
Intended Location	Outdoor
Degree of Protection (IP)	IP44 (IEC 60529)
Protection against Mechanical Impact (IK)	IK10 (IEC 62262)
Rated Insulation Voltage U_i	1,000 V AC
Enclosure Material	
Material Type	Glass-fibre reinforced polyester (EN 14598-1 UP)
Colour	RAL 7035
Material Conformity	Low-Voltage Directive 2014/35/EU RoHS Directive 2011/65/EU + RoHS 2015/863/EU (Amendment) REACH Regulation EC 1907/2006
General Characteristics	
Surface Structure	Ribbed
Surface Treatment	Untreated
Protection Class	II
Permissible Loads	See chapter <i>Permissible Loads</i>
Environmental Conditions	
Ambient temperature min./max./24 h average	-25 °C / 40 °C / 35 °C Working temperatures for devices must be considered.
Humidity conditions	Relative humidity temporarily as high as 100 % at a max. temperature 25 °C
Pollution Degree	3
Electrical Characteristics	
Dielectric Strength	14.5 kV (IEC 61439-1:2020)
Tracking Resistance	CTI 600 (IEC 60112)
Thermal Characteristics	
Glow-wire test	960 °C (IEC 60095-2-12)
Flammability	V0 3.5 mm (UL 94)
Heat Resistance	> 140 °C (IEC 62208 / IEC 60216)
Chemical Characteristics	
Halogen content	Halogen free
UV and Corrosion Resistance	
UV resistance, mechanical	> 70 % retaining values of flexural strength (ISO 178) and Charpy impact (ISO 179)
Corrosion Resistance of Metal Parts	Damp heat cycling test (IEC 60028-2-30), Severity A, 55 °C, 6 cycles and variant 1
Further Requirements according to IEC 62208	
Axial Loads of Metal Inserts	Compliant to section 9.6
Thermal Stability (9.9.1)	Dry heat IEC 60068-2-2 Test Bb / 70 °C

Resistance to Normal Heat (9.9.2)	IEC 60085
Resistance to Abnormal Heat and to Fire (9.9.3)	960 °C IEC 60695-2-10 / -11
Dielectric Strength (9.10)	1.5 times 2,200 VAC

Interface characteristics

In respect to IEC 62208

Characteristic	Value
Voltage Ratings	
Rated voltage U_n	400 V AC
Rated operational voltage U_e	400 V AC
Rated insulation voltage U_i	1,000 V AC
Rated impulse withstand voltage U_{imp}	up to 8 kV consider the values of the devices
Current Ratings	
Rated diversity factor RDF	none
Rated frequency f_n	50 Hz

Classification (IEC 62208:2023-06, cl. 4)

a) type of material:

insulating

b) method of fixing:

floor standing (in-ground mounting)

c) intended location:

outdoor

d) degree of protection:

IP Code (IEC 60529): **IP44**

IK Code (IEC 62262): **IK10**

e) rated insulation voltage:

1,000 VAC

Other characteristics (IEC 62208:2023-06, clause 6.3)

a) dimensions (see 6.3.2)

See product table on page 33

b) mounting arrangements (see 6.3.3)

All enclosures are either empty or equipped with mounting plates. Empty enclosures have perforated strips integrated in the backwall for inserting M6 insert nuts. Those are used for fastening a mounting plate. Mounting plates are made of PVC and 6 mm thick.

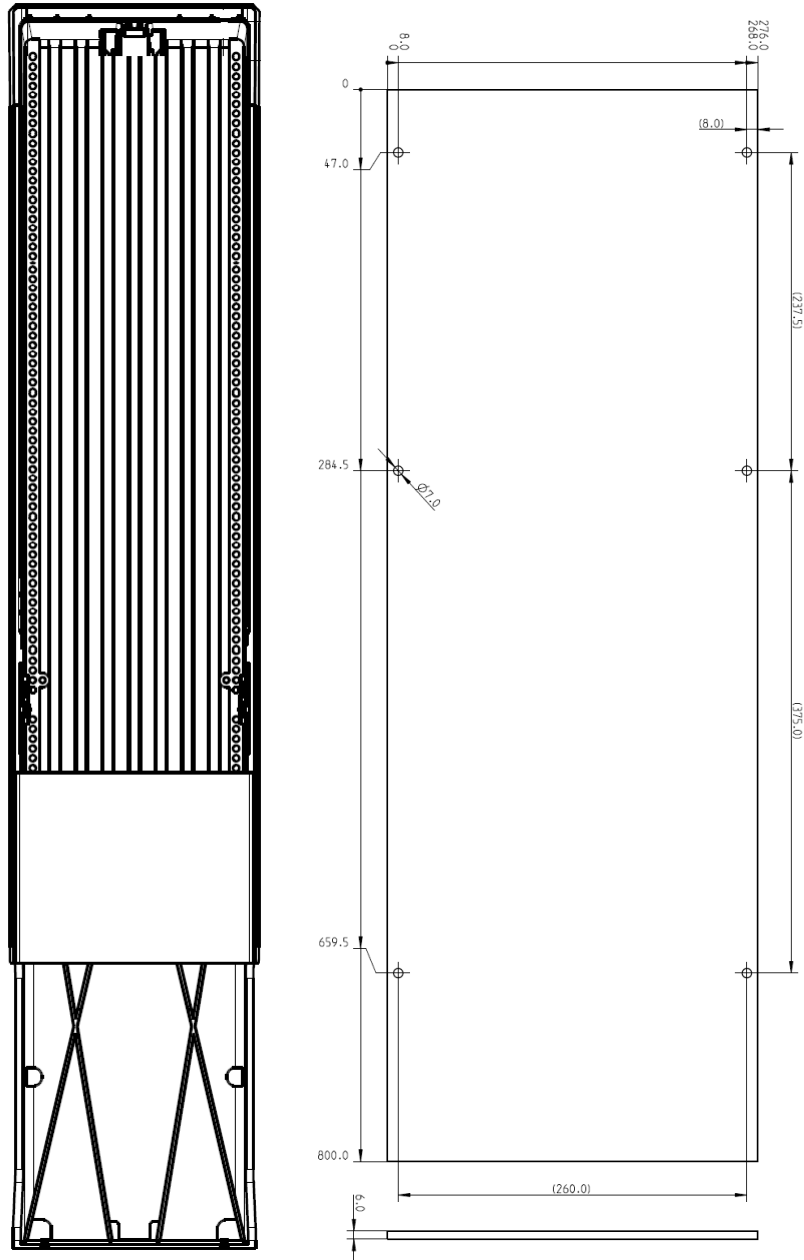

Left: Representative figure of a back wall of an empty cabinet with the perforated strip to mount the mounting plate. / Right: representative figure of a mounting plate.

The following table shows the dimensions of the mounting plates integrated in the corresponding cabinets.

Cabinet Product Reference	Mounting Plate Reference	Dimensions Mounting Plate H x W x D / mm x mm x mm
ZAL142P	ZAY47433M	800 x 276 x 6
ZAL162P	ZAY47434M	600 x 276 x 6

c) permissible loads (see 6.3.4)

Cabinet Product Reference	Permissible Load Mounting on backwall	Permissible Load Mounting on door
ZAL142 / ZAL142P	50 kg	1 kg
ZAL162 / ZAL162P	50 kg	1 kg

d) lifting and transport devices, if necessary (see 6.3.5)

The cabinets have no lugs to attach lifting devices. Transportation of the cabinet on pallet is recommended.

e) protective measures (see 6.3.6)

Protection class II

f) thermal power dissipation capability (see 6.3.7)

see dedicated chapter on page 41f.

g) applicable service conditions (see cl. 7)

Ambient air temperature: - 25 °C to max. 40 °C (short-term) / 35 °C (average over a period of 24 hours)

Humidity conditions: 15 % to max. 100 % (at a temperature range of -25 °C to +27 °C) / 60 % (at temperature of 35 °C) / 46 % (at a temperature of 40 °C)

Moderate condensation can occur inside the cabinet due to shifts in temperature levels. The use of base filler material ZAY95075 is a prerogative to avoid excessive condensation and humidity ingress through the soil (in-ground application). The following table shows the necessary amount of ZAY95075 (25 l bag of base filler material).

Cabinet Product Reference	Necessary amount of ZAY95075
ZAL142 / ZAL142P	1 bag
ZAL162 / ZAL162P	

h) location and size of protected space

see dedicated chapter on page 40

i) rated insulation voltage U_i of enclosures constructed of an insulating material and Class II enclosures (see 9.11.3, Table 4)

1,000 V AC

j) degree of protection against mechanical impact (IK code, see 8.6)

IK10

k) degree of protection against contact with hazardous live parts, ingress of solid foreign bodies and water (IP code, see 8.7)

IP44

l) maximum permissible temperatures inside for which enclosures constructed of insulating material is suitable (see 9.10.2)

The temperature inside the enclosure shall never exceed 70 °C. The operating temperatures of the intended devices must be considered.

Definition of Protected Space and IP Protection

The protected space inside the cabinets begins at the inner top of the cabinet and reaches down as far as defined by height A in the table below. The width of the protected space is shown as parameter B in the table and is 8 mm away from the left and 30 mm away from the right inner side wall of the cabinet. Parameter C shows the depth of the protected space beginning from the inner back wall of the cabinet.

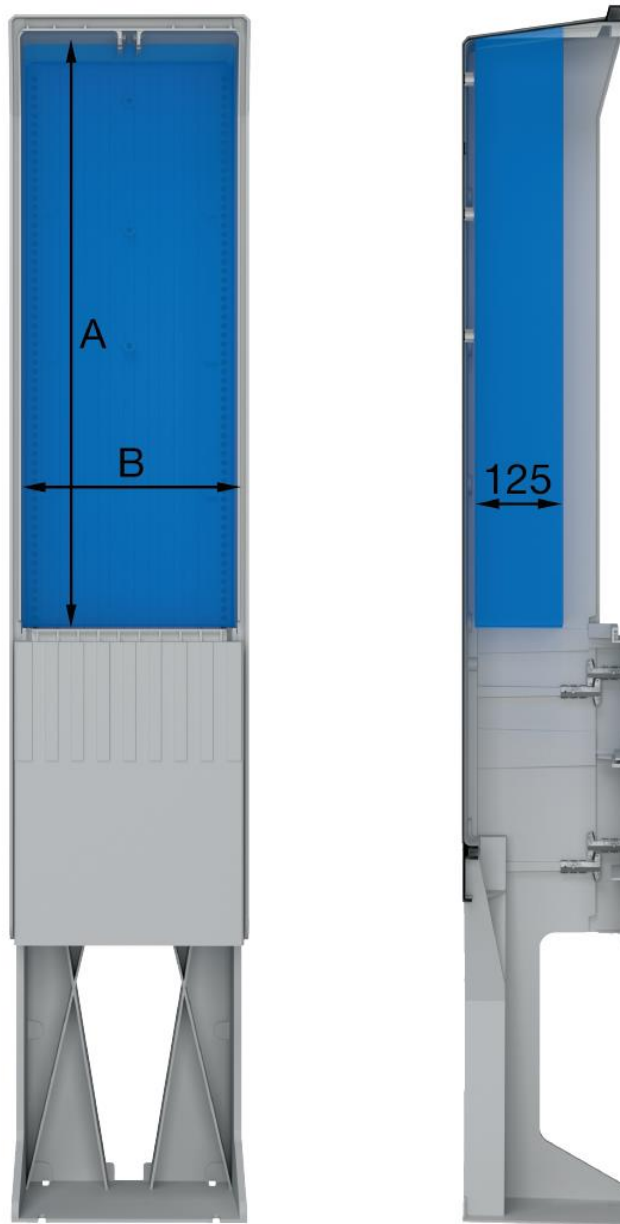

Cabinet Reference	A = Height / mm	B = Width /mm	C = Depth / mm
ZAL142*	650	250	125
ZAL162*	800	250	125

Thermal Power Dissipation

The overview of these values are shown in the table below, indicating the maximum power dissipation capability of the cabinet at a temperature increase of $\Delta T = 35 \text{ K}$ at an ambient temperature of $35 \text{ }^\circ\text{C}$, with the maximum temperature at 100 % cabinet height. This is therefore the worst-case value for the assembly.

Reference	Outer dimensions H x W x D / mm	$P_{\text{max}} /$ W	Weight / kg empty / w/ mounting plate
ZAL142*	1,420 x 320 x 225	80	13 / 15
ZAL162*	1,595 x 320 x 225	115	14 / 17

The verification of temperature-rise according to IEC 62208 can be achieved via calculation as described in sub-clause 9.15.4 in that standard. When designing the assembly, the temperature-rise limits must be respected. It falls to the assembly manufacturer to fulfil this verification when designing the assembly.

The following values are representative for the maximum power dissipation capability of the cabinets. Thus, the sum of all power dissipation values of all installed electrical equipment like cables, devices, meters, etc. must be smaller than the values below in the tables below. The installation situation, ambient temperature and the installed device with the lowest maximum operating temperature determine which value must be considered for the assembly.

Following, the tables show the calculated values for all cabinets in accordance with IEC 60890.

Key:

Location of temperature reference point:

t1,0: at 100 % height of the cabinet

t0,75: at 75% height of the cabinet

t0,5: at 50 % height of the cabinet

Type of installation:

FR: free standing enclosure

AP: wall mounting enclosure

ZAL142*

ΔT	t1,0	t0,75	t0,5
	FR	FR	FR
+5K	7 W	7 W	9 W
+10K	16 W	16 W	22 W
+15K	27 W	27 W	36 W
+20K	39 W	39 W	52 W
+25K	52 W	52 W	69 W
+30K	66 W	66 W	86 W
+35K	80 W	80 W	105 W

ZAL162*

ΔT	t1,0	t0,75	t0,5
	FR	FR	FR
+5K	10 W	10 W	13 W
+10K	24 W	24 W	32 W
+15K	40 W	40 W	53 W
+20K	57 W	57 W	76 W
+25K	75 W	75 W	101 W
+30K	95 W	95 W	126 W
+35K	115 W	115 W	153 W