

Application description EASY

KNX building management system

KNX push-button module

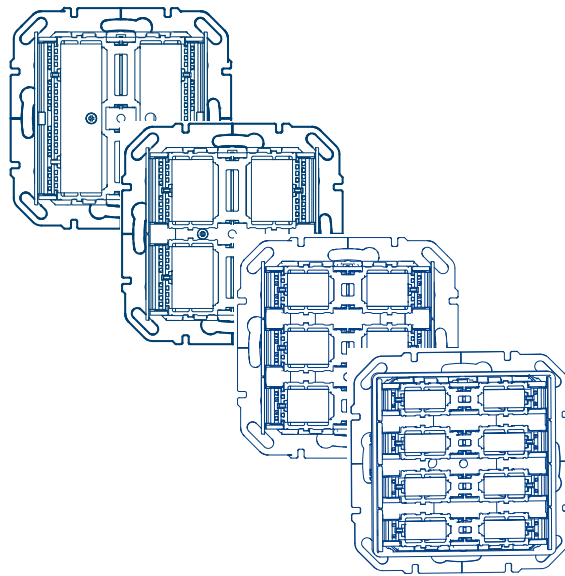

Push-button sensor technical unit, x-gang,
KNX Secure

81181000, 81184000, 81186000, 81188000



Product overview









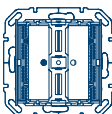

	Order number	Product designation	Application programme	TP product Radio product
	8118 1000	Push-button insert, 1-gang, KNX Secure		TP product
	8118 4000	Push-button insert, 4-gang, KNX Secure		TP product
	8118 6000	Push-button insert, 6-gang, KNX Secure		TP product
	8118 8000	Push-button insert, 8-gang, KNX Secure		TP product

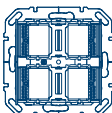
Table 1: Product overview

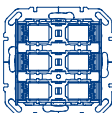
We reserve the right to make changes of a technical nature.

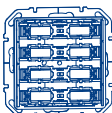
1	Table of contents.....	3
2	General.....	6
2.1	General information about this application description.....	6
2.2	Programming software configuration tool.....	6
2.3	Commissioning.....	6
3	Function and device description.....	7
3.1	Device overview.....	7
3.2	Functional description.....	8
3.3	Operating concept.....	8
3.3.1	Button/input.....	9
3.3.2	Range of functions.....	9
3.4	Functional overview.....	11
4	Project preparation.....	19
4.1	Project editing.....	19
4.2	Selecting the device.....	19
4.2.1	Menu section — Parameters.....	20
4.3	Overview inputs/outputs.....	22
4.4	Parameterisation of Status LED/backlighting.....	23
4.4.1	Function status LED.....	23
4.4.2	Overview of outputs.....	23

5	Independent push-button configuration.....	26
5.1	Lighting functions.....	28
5.1.1	Function on  /off 	28
5.1.2	Switching function (buttons).....	28
5.1.3	'Toggle switch' function.....	29
5.1.4	Timer function.....	29
5.1.5	Master ON/OFF function.....	29
5.1.6	Priority On/Off toggle function.....	30
5.1.7	Scene function.....	32
5.1.8	Automatic control deactivation toggle.....	33
5.1.9	Overview of all possible linking combinations.....	34
5.2	Dimming functions.....	38
5.2.1	Dimming Up (On)/Down (Off) functions.....	38
5.2.2	Dimming Up/Down functions.....	38
5.2.3	Dimming function.....	38
5.2.4	Colour temperature colder/warmer.....	39
5.2.5	Colour scrolling forwards/backwards.....	39
5.2.6	Scene function.....	40
5.2.7	Automatic control deactivation toggle.....	40
5.2.8	Overview of all possible linking combinations.....	40
5.3	Roller shutter function.....	43
5.3.1	Basics of roller shutter/blind control.....	43
5.3.2	Functions blinds up / blinds down.....	46
5.3.3	Roller shutter position function.....	47
5.3.4	Function slat angle.....	47
5.3.5	Functions Roller shutter and slat position.....	47
5.3.6	Functions roller shutter up / roller shutter down.....	48
5.3.7	Priority up toggle/down toggle functions.....	48
5.3.8	Master up/Master down.....	49
5.3.9	Scene function.....	50
5.3.10	Automatic control deactivation toggle.....	50
5.3.11	Overview of all possible linking combinations.....	50
5.4	Functions Heating/cooling.....	53
5.4.1	Function Comfort mode.....	54
5.4.2	Function Standby mode.....	54
5.4.3	Eco mode function.....	54
5.4.4	Function Protection mode.....	54
5.4.5	Function Setpoint offset.....	55
5.4.6	Function Priority comfort toggle.....	55
5.4.7	Priority protection toggle function.....	56
5.4.8	Function Heating / cooling toggle.....	56
5.4.9	HVAC mode switch.....	56
5.4.10	Increase/decrease the setpoint.....	57
5.4.11	Scene function.....	57
5.4.12	Automatic control deactivation toggle.....	57
5.4.13	Overview of all possible linking combinations.....	57
5.5	Audio functions.....	60
5.5.1	Scene function.....	62
5.5.2	Automatic control deactivation toggle.....	62
5.5.3	Overview of all possible linking combinations.....	62

6	Temperature sensor function parameters.....	63
6.1	Internal temperature sensor.....	63
6.2	External temperature sensor.....	63
7	Appendix.....	65
7.1	Technical data.....	65
7.2	Accessories.....	65
7.3	Accessories.....	67
7.4	Accessories.....	69

2 General

2.1 General information about this application description

This document describes the programming and setting of easy-compliant KNX products using the *Configuration tool*.

2.2 Programming software configuration tool

The application programs for the KNX products are already preinstalled in the configuration tool.



If the current application software is not available in the configuration tool, then the configuration tool must be updated (see 'Configuration tool' installation handbook).

2.3 Commissioning

The commissioning process for the device refers primarily to the linking of the buttons (hereinafter inputs) and the switch actuator outputs (hereinafter outputs) as well as the selection of the respective push-button functions (switching, dimming, roller shutter/blind, etc.).



The commissioning process for the configuration tool can be found in the corresponding instructions.

Programming with the configuration tool is restricted to one bus line and does not require a line coupler. As a result, it is possible to combine wired and wireless-network KNX devices.

3 Function and device description

3.1 Device overview

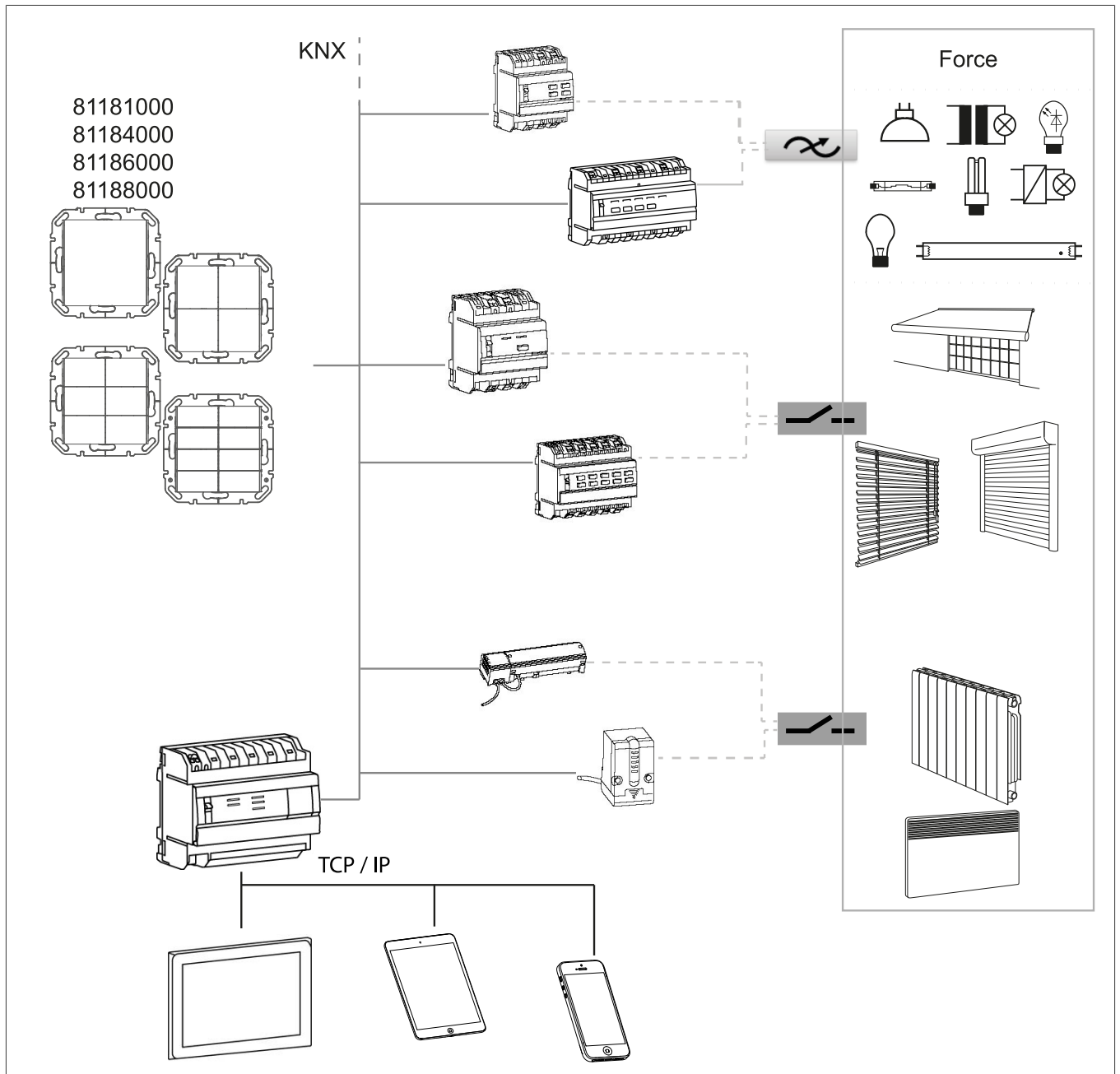

Fig. 1: Device overview

3.2 Functional description

The devices are monoblock modules with an integrated bus coupling unit. The following functions can be assigned to the inputs:

- Switching
- Dimming
- Roller shutter
- Heating / cooling
- Audio

The assignment of functions can be freely selected for each input and is determined by the settings. Depending on the function settings, telegrams are transmitted to the KNX system bus. They trigger the corresponding switching, dimming, blind/roller shutter functions, open or save light scenes and set dimming, brightness or temperature values by touching the button.

3.3 Operating concept

The function of the individual buttons/inputs is dependent upon the programming of the device. Depending on the version, devices are fitted with up to eight pressing points.

Triggering of functions and operation of electrical loads takes place via push-button operation areas (Fig. 2: Push button operation areas), dashed) and can be set individually for each device.

Example: Push-button 4-gang

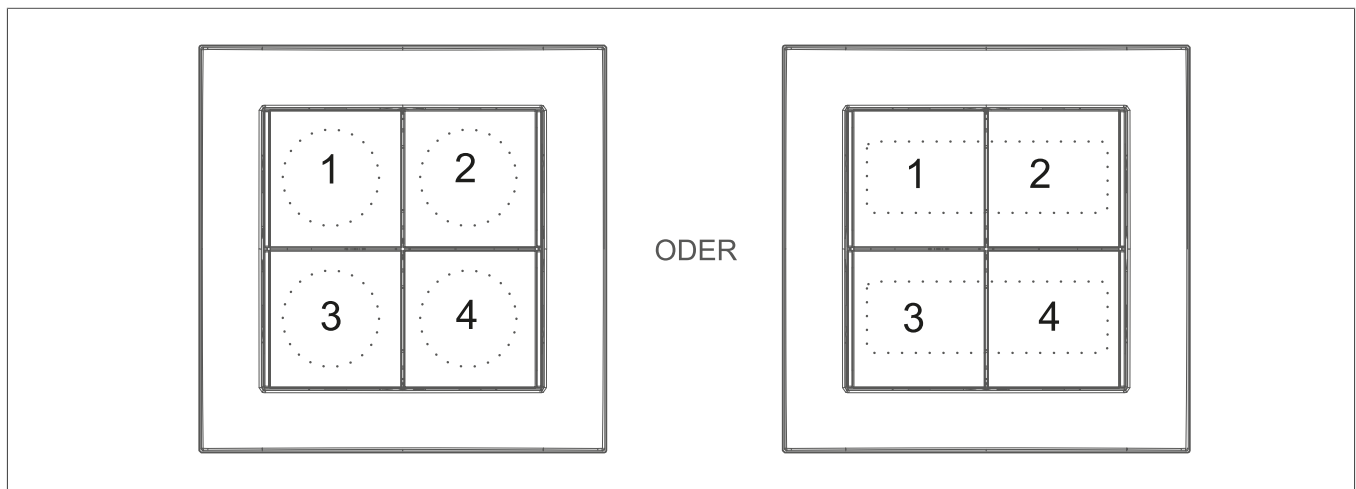

Fig. 2: Push button operation areas

Operation of the single button:

- Switching lighting on/off and dimming brighter/darker is carried out alternately by repeated pressing of a push-button operation area.

Operation as rocker (pair of buttons):

- Two adjacent push-button operation areas form a pair of buttons. For example, touching the left-hand area switches the lighting on/makes it brighter; touching the right-hand area switches it off/makes it darker.

Operating guide

The device differentiates between short and long touches.

Short press operation

- Switching the lighting
- Roller shutter/blind: The device sends the Stop or Slat step command to the bus via the corresponding communication object (slat step). Switching the lighting
- Timer: The ON command is transmitted through the Timer object for the time set at the output.

Long press operation

- Dimming the lighting
- Roller shutter/blind: The device sends an Up/Down move command via the bus through the corresponding communication object (move).
- Timer: The OFF command interrupts active timer operation through the Timer object and switches the output off directly.
- Scene: Keep the scene button pressed. The outputs in question flash briefly to confirm that the configurations have been saved.



Note

The detection time for a long key press is already configured in the system.

3.3.1 Button/input

The left (1) or right (2) side are designated as input. The respective inputs can work independently of each other → 1-push-button operation (e.g. left push-button operation area → Roller shutter UP/DOWN and right push-button operation area light ON/OFF) but can also work together in a single function → two-push-button operation (light switching: left ON/right OFF).

3.3.2 Range of functions

- A function can be assigned to each button (input).
- Each individual button can be used for one function from lighting, dimming, roller shutter, heating/cooling to Audio.

Lighting

Each button can be assigned one of the following functions: 'On, Off, Switching, Toggle switch, Timer, Priority on/off toggle, Scene, Automatic control deactivation toggle'.

- On
- Off
- Switching
- Toggle switch
- Timer
- Priority On toggle
- Priority Off toggle
- Master on
- Master off
- Scene
- Automatic control deactivation toggle

Dimming

Each key can be assigned one of the functions.

- Dimming up (on)
- Dimming down (off)
- Dimming Up/Down
- Dimming
- Colour temperature colder
- Colour temperature warmer
- Colour scrolling forwards
- Colour scrolling backwards
- Scene
- Automatic control deactivation toggle

Roller shutter

Each key can be assigned one of the functions.

- Blind open
- Blind up
- Roller shutter up
- Roller shutter down
- Position shutter
- Slat angle
- Position roller shutter and slat
- Priority Up toggle
- Priority Down toggle
- Master control Up
- Master control Down
- Scene
- Automatic control deactivation toggle

Heating / cooling

Each key can be assigned one of the functions.

- Comfort mode
- Eco mode
- Standby mode
- Protection mode
- Setpoint Offset
- Priority Comfort toggle
- Priority Protection toggle
- Heating/cooling toggle
- HVAC mode switch
- Increase the setpoint value
- Decrease the setpoint value
- Scene and automatic control deactivation toggle

Audio

Each key can be assigned one of the functions.

- Audio on
- Audio off
- Audio On Off
- Loudness +

- Loudness -
- Audio Favorite
- Scene
- Automatic control deactivation toggle

Status LED / Backlight

Status LED

- Each button has an RGB status LED.
- The colour of the RGB status LED for on or off is to be set centrally.

Backlighting

- The backlighting can be set to **Always on**, **Always off** or as **Status display (on/up/down at 1)**.

The full lighting on the device, the status LED and the backlighting can be fully switched off using an external command.

Temperature probe

The device has an internal temperature sensor and connection terminals for an external temperature sensor. In addition, the room temperature can be measured, processed and sent to the bus.

3.4 Functional overview

The functions described in the following section enable the individual configuration of the device inputs or outputs.



The symbols are also shown in the appendix as an overall overview.

No function

The **No function** function means that no function is assigned to the button. The button is disabled.

Lighting

ON/OFF

- With the **On/Off** function, the lighting is switched on or off when the relevant configured button is pressed.

Switching (push button function)

- The **Switching** function is a push-button function which causes the device to send a '1-command' to the bus when the button is pressed and a '0-command' when the button is released.

Toggle switch

- The **'Toggle switch'** function switches on the lighting upon the first key-press and switches it off again upon the second.

Timer

- The **Timer** function enables the actuator output to be switched on for an adjustable duration. The switching time can be interrupted before the delay time elapses. An adjustable switch-off warning signals the end of the delay time by inverting the output state for 1 s.

Priority on toggle/Priority off toggle

- The **Priority** function makes it possible to specify a defined condition or to force a defined condition of the function.

Master On/Master Off

- The **Master ON/OFF** function allows a common ON or OFF command to be sent from a central point.

Scene

- In the **Scene** function, several switching/dimming/blind outputs can be grouped together and switched on/off at the touch of a button. A maximum of 8 scenes can be created.

Automatic control deactivation toggle

- This function can be used for time-controlled switching, interrupting and deactivating of ongoing operations, e.g. lighting.

Communication commands Lighting function

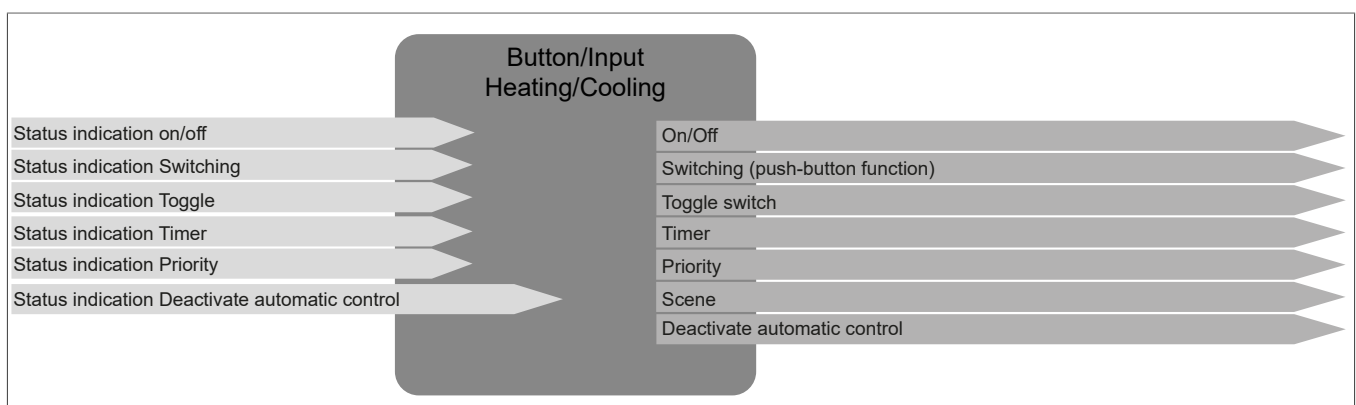

Fig. 3: Input/output signals Lighting function

Dimming

Dimming up (on)/Dimming down (off)

- With the **Dimming** function, the lighting or lighting circuit can be dimmed up or down (long press of the button) or switched on or off (short press of the button) by pressing the relevant configured button.

Dimming Up/Down

- With the **Dimming up/down** function, the lighting can be dimmed up/down with the same button.

Dimming

- The lighting is assigned a certain brightness value in percent with the **Dimming (dimming value %)** function.

Colour temperature colder

- The **Colour temperature colder** function reduces the colour temperature of the lighting.

Colour temperature warmer

- The **Colour temperature warmer** function increases the colour temperature of the lighting.

Colour scrolling forwards

- With the **Colour scrolling forwards** function, a new colour is assigned to the lighting with each button press (clockwise).

Colour scrolling backwards

- With the **Colour scrolling backwards** function, a new colour is assigned to the lighting with each button press (anti-clockwise).

Scene

- In the **Scene** function, several switching/dimming/blind outputs can be grouped together and switched on/off at the touch of a button. A maximum of 8 scenes can be created.

Automatic control deactivation toggle

- This function can be used for time-controlled switching, interrupting and deactivating of ongoing operations, e.g. lighting.

Communication commands Dimming function

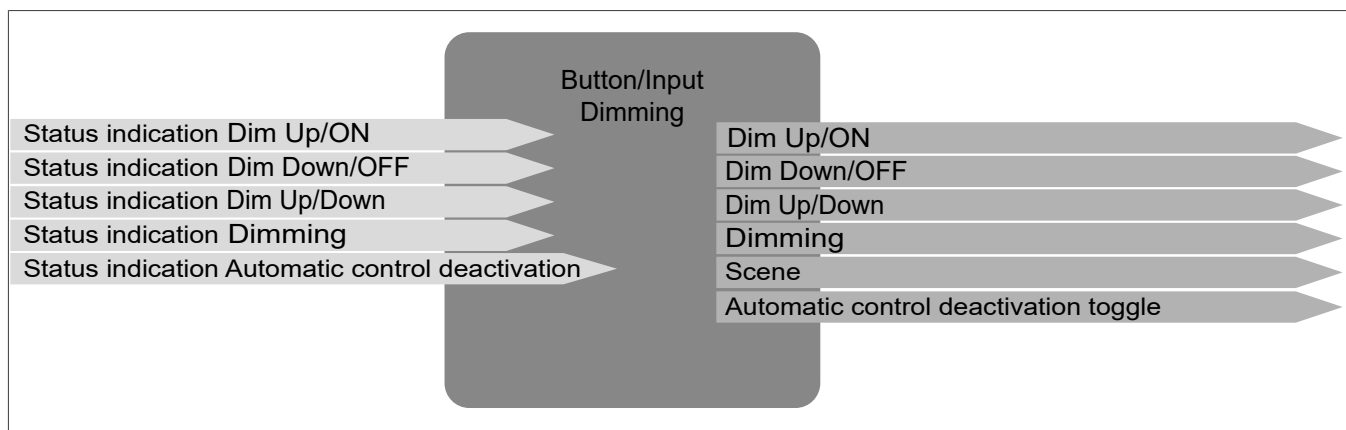

Fig. 4: Input/output signals Dimming function



All functions from the **Lighting** function group can be linked with a dimming output. However, only the relevant **switching command** is executed in the switch output.

Roller shutter

The Roller shutter function allows blinds, roller shutters, awnings or similar hangings to be opened and closed.

Roller shutters up/down - Blinds up/down

- With these functions, it is possible to move a roller shutter/blind up/down or to open/close an awning, for example, by pressing the button.

Position of roller shutters/slat angle/position of roller shutters and slat

- With these functions, it is possible to set the position of the roller shutter/blind or the angle of the slat by pressing the button.

Priority up toggle/down toggle

- With these functions, it is possible to impose the up/down command in a roller shutter/blind actuator by pressing the button; in other words, the position that is currently set is interrupted and Priority mode is switched on. The Priority control function makes it possible to specify a defined condition for forcing a defined condition of the function, for example: Window cleaner function.

Scene

- In the **Scene** function, several switching/dimming/blind outputs can be grouped together and switched on/off at the touch of a button. A maximum of 8 scenes can be created.

Automatic control deactivation toggle

- This function can be used for time-controlled switching, interrupting and deactivating of ongoing operations, e.g. blinds.

Communication commands Roller shutter function

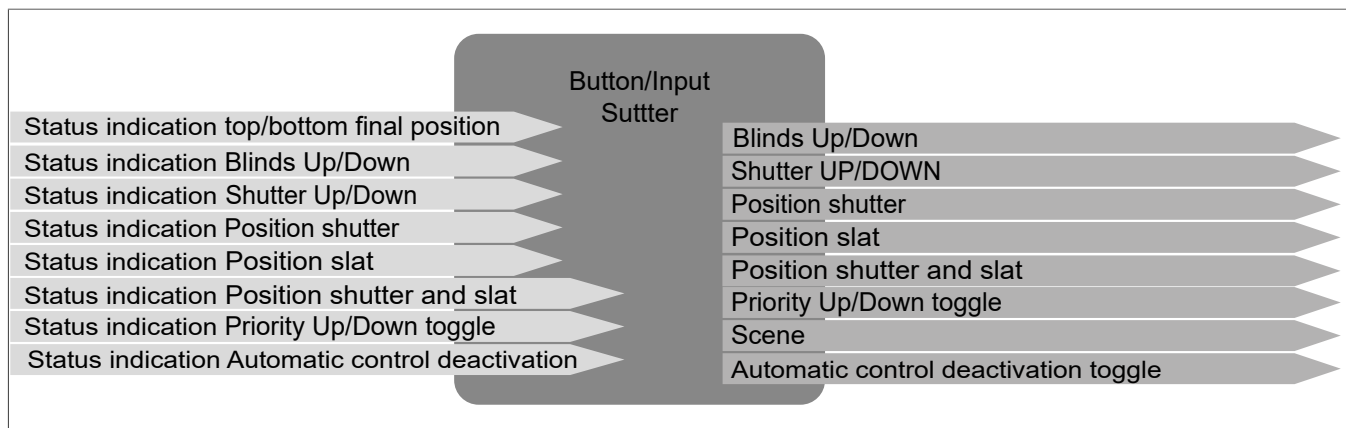

Fig. 5: Input/output signals Roller shutter function

Heating / cooling

Operating mode

- Comfort mode
- Eco mode
- Standby mode
- Protection mode

With one of these functions, it is possible to switch on/toggle the relevant operating mode – Comfort, Eco, Standby or Protection – by pressing the button.

Setpoint shift

- With this function, it is possible to increase/decrease the set temperature setpoint in the thermostat by pressing the button.

Priority comfort toggle/Priority protection toggle

- With one of these functions, it is possible to activate the Comfort/Protection mode on a thermostat by pressing the button. This action overrides the ongoing heating or cooling operation and immediately switches the device to Priority mode. The Priority function makes it possible to specify a defined condition or to force a defined condition of the function.

Heating/cooling toggle

- With this function, it is possible to change between heating and cooling.

HVAC mode switch

- This **HVAC mode switch** function switches off the heating or cooling system each time a button is pressed.

Increase the setpoint/decrease the setpoint

- The function increases or decreases the setpoint value by 0.1°C each time the button is pressed.

Scene

- In the **Scene** function, several switching/dimming/blind outputs can be grouped together and switched on/off at the touch of a button. A maximum of 8 scenes can be created.

Automatic control deactivation toggle

- This function can be used for time-controlled switching, interrupting and deactivating of ongoing operations, e.g. blinds.

Communication commands Heating/cooling function

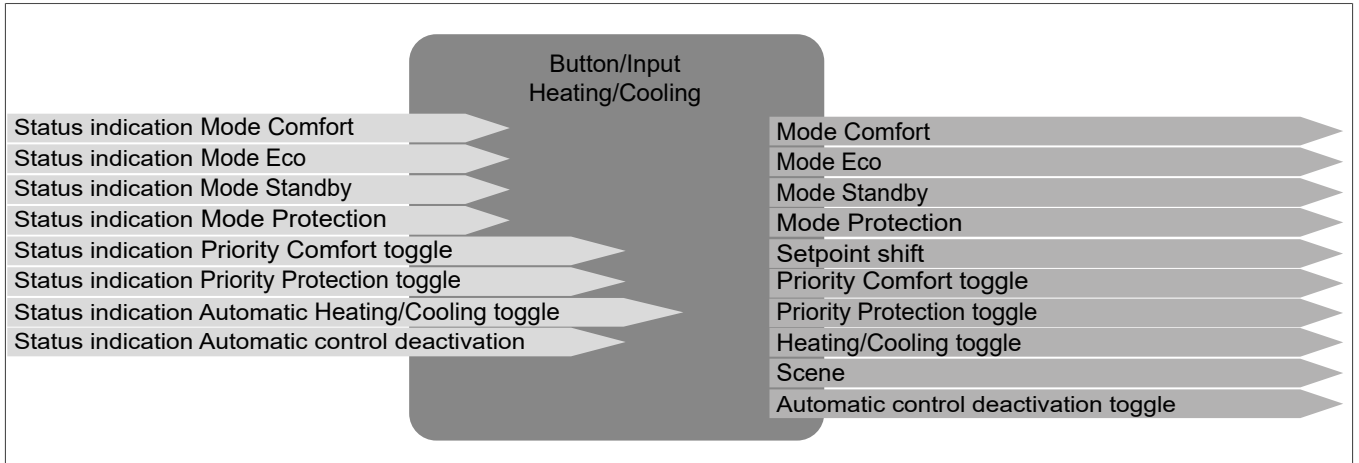

Fig. 6: Input/output signals Heating/cooling function

Audio

Audio On/Audio Off

- With the **Audio On/Audio Off** function, pressing a button on the device will either turn the connected music source on or off.

Audio On Off

- When the **Audio On function is off**, pressing a button on the device causes the connected music source to be switched on or off (Toggle function).

Volume +/Volume -

- With the **Volume +/Volume -** function, pressing a button on the device increases or decreases the volume of the connected music source.

Audio Favorite

- With the **Audio favourite** function, pressing a button on the device causes the connected music source to play the stored audio favourite file.

Scene

- In the **Scene** function, several switching/dimming/blind/audio outputs can be grouped together and switched on/off at the touch of a button. A maximum of 8 scenes can be created.

Automatic control deactivation toggle

- This function can be used for time-controlled switching, interrupting and deactivating of ongoing operations, e.g. blinds.

Communication commands Audio function

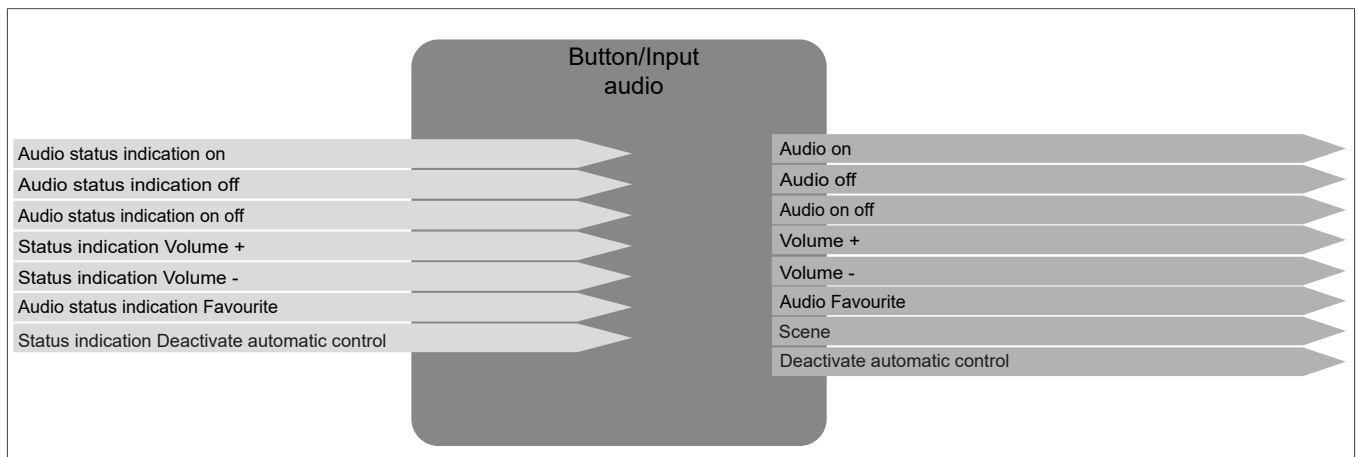

Fig. 7: Input/output signals Audio function

4 Project preparation

The following sections describe the configuration of the parameters for 1 to 4-gang push button devices. The function of the different devices only differs in the number of inputs. For this reason, only the first input pair/button pair will ever be described.



Parameterisation and commissioning are carried out using the *configuration tool*.

If all devices are integrated into the project, then you can start configuring the device.



The set parameters are updated continuously during the configuration. The device signals that the parameters are being updated by making all of the status LEDs flash blue.

4.1 Project editing

To ensure that the commissioning process with the **configuration tool** is successful, the following requirements must be met:

- ▶ A network connection to the **configuration tool** has been established.
- ▶ All of the devices used (wired or wireless) are connected to the **configuration tool**.
- ▶ Start the **configuration tool** software (browser version or tablet app).
- ▶ Create the project and enter the project-specific data (project name, address, customer data).
- ▶ Click on search to scan devices.
- ▶ The **configuration tool** has scanned the device and started with the parameterisation.

4.2 Selecting the device

First of all, the corresponding device must be selected in the device list to start the configuration.

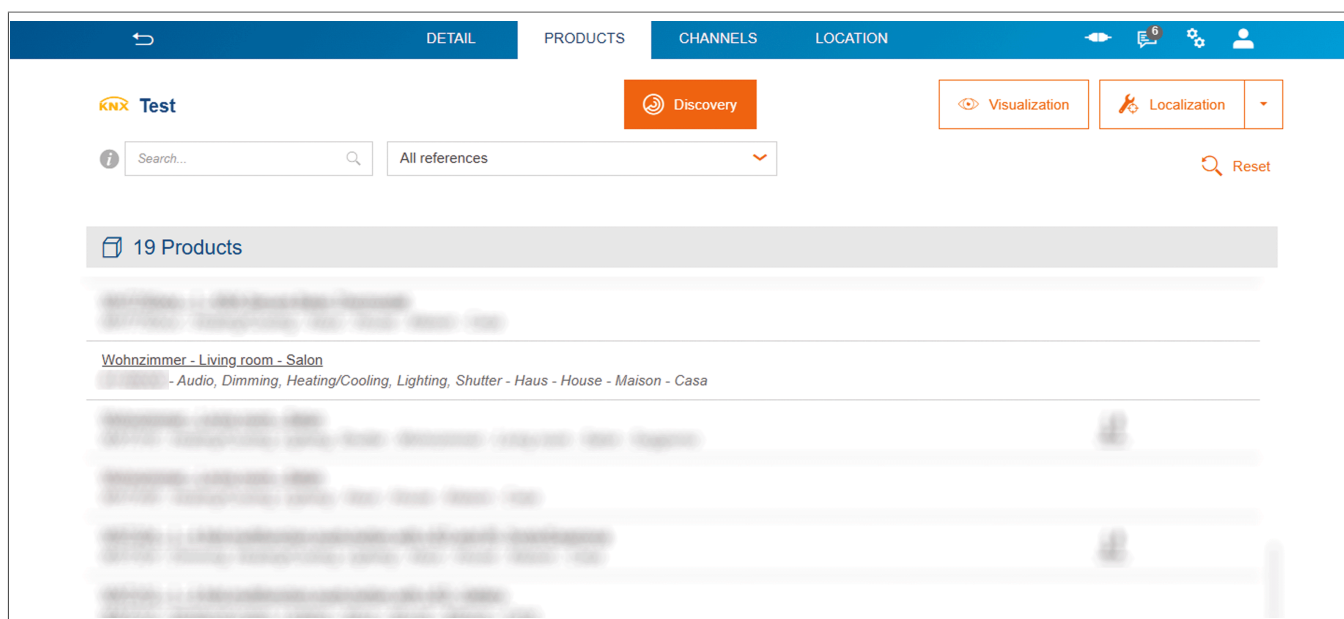

Fig. 8: Selecting the device

- Select the device in the device overview. The following view opens.

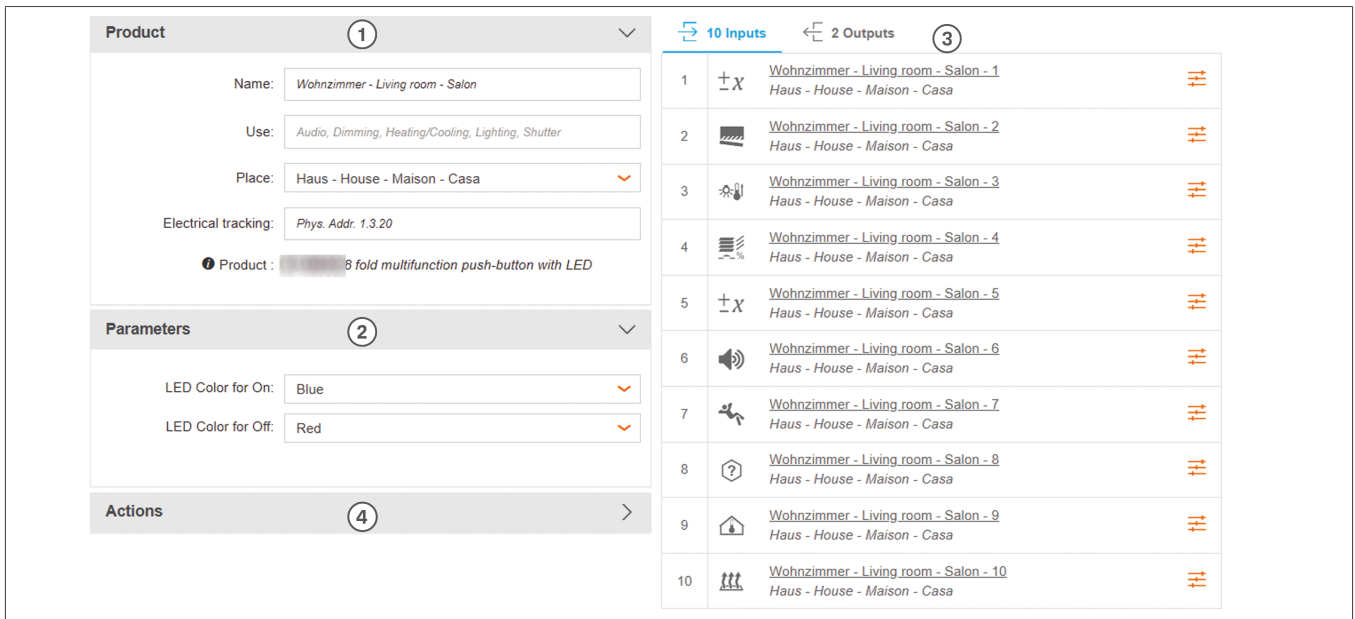

Fig. 9: Home page

The view is divided into four sections.

Device (①)

- General information such as name, application, location of the device and name are listed under **Device**.

Parameters (②)

- Depending on the input selection, the parameters and values that can be set and changed are visible under **Parameters**.

Inputs/outputs (③)

- The available inputs of the device are listed under Inputs.
 - Input 1-8: Inputs of single button, depending on function selection
 - Input 9: Internal room temperature sensor 🏠
 - Input 10: External room temperature sensor 🌡️
- Output 1: Backlighting [FPL]
- Output 2: Turn off the device LEDs 🚫

Other (④)

- General settings on the device can be configured under menu Actions.

4.2.1 Menu section — Parameters

Under Parameters, the settings for the colour of the status LED must be defined for the connected load in both ON and OFF operating status. These settings are made for the entire device.

LED colour for on/off
Off
Red

Table 2: Colour choice status LED

LED colour for on/off

Green

Blue

Red/green

Red/blue

Green/blue

White

Table 2: Colour choice status LED

Parameter	Description	Value
LED colour for on	This parameter allows the status LED colour when ON to be set for the entire device.	Off Red Green Blue Red/green Red/blue Green/blue White
LED colour for off	This parameter allows the status LED colour when OFF to be set for the entire device.	Off Red Green Blue Red/green Red/blue Green/blue White

4.3 Overview inputs/outputs

The number of device inputs and outputs is determined by the device type used.

The figure below shows the inputs for the push button on the left-hand side and the outputs on the right-hand side.















10 inputs 		2 outputs 	
	Room -1 Home		Room -1 House - lighting
	Room -2 Home		Room -1 House - lighting
	Room -3 Home		
	Room -4 Home		
	Room -5 Home		
	Room -6 Home		
	Room -7 Home		
	Room -8 Home		
	Room -9 Home		
	Room -10 Home		

Table 3: Overview inputs/outputs

The device shown features a total of 10 inputs and two outputs. The inputs are split into the actual inputs/buttons 1-8 and two inputs for configuring the temperature control.

- Inputs/push buttons 1 - 8

The ‘Lighting – Dimming – Roller shutters – Heating/cooling’ functions can be assigned to the inputs/buttons 1-8.

- Inputs/push buttons 9 - 10

These inputs/buttons are assigned the ‘Room temperature sensor’ and ‘Floor temperature sensor’ functions permanently.

Outputs refer to functions which are triggered by pressing another button or by timer functions, e.g. function of backlighting or switching off all status LEDs on the device if necessary.

- Output 1: Backlighting 

In the parameters for output 1, the settings and function of the backlighting must be made.

– Output 2: Switching off the status LEDs 

Under output 2, the status LEDs for the entire device can be switched off if necessary, e.g. at night (1-command) and switched back on again in the day with a 0-command.

4.4 Parameterisation of Status LED/backlighting

4.4.1 Function status LED

In this section, the functions of the status LEDs for the each individual input are described. Each button is fitted with an RGB status LED that is connected internally to the operating function depending on the function of the buttons.



The colour of the status LEDs is set centrally under Menu field - Parameters (see [Menu section — Parameters](#)).

Always Off
Always On
Status display (on/up/down at 1)
Status display flashing at 1

Table 4: Function selection status LED

Parameter	Description
Always Off	The status LED of the selected button is always switched off.
Always On	The status LED of the selected button is always switched on.
Status display (on/up/down at 1) ¹	The status LED of the selected button is switched on with an on, up or down command.
Status display flashing at 1	The status LED of the selected button is switched on flashing with an on, up or down command. The flashing frequency is 2 Hz.

Table 5: Function of the status LED

¹ * If an output is controlled by several inputs, then the function of the status LED is set to status indicator (on/up/down at 1) automatically for all devices used.

4.4.2 Overview of outputs

The device has two outputs.

Output 1: Backlighting 

Output 2: Switch off device LEDs 



Fig. 10: Overview of outputs

Backlighting

To be able to set the function of the backlighting, all of the outputs of the device must be selected first. Clicking on the symbol opens a parameter window to set the function of the backlighting.

The LEDs for the backlighting are only visible when using the buttons for the push-button sensor module, x-gang, backlit (see [Chapter 7.2](#)).

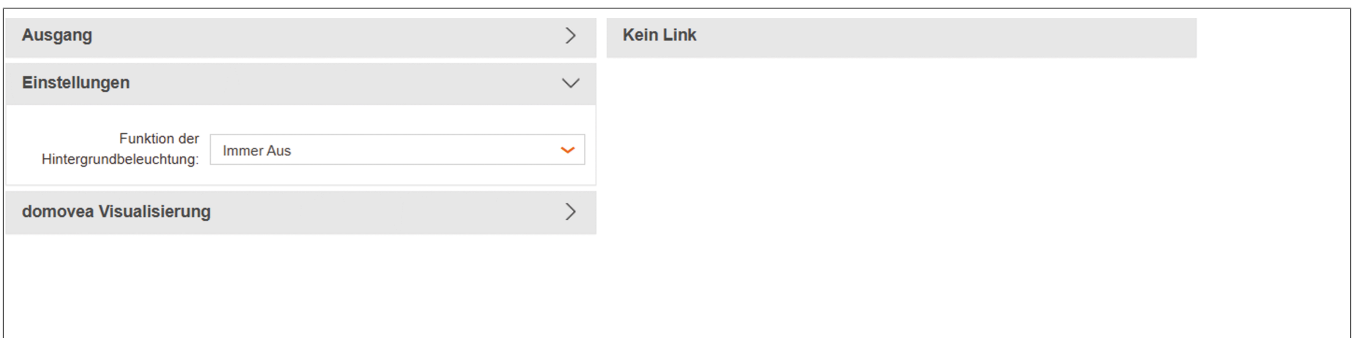

Fig. 11: Backlighting

Parameter	Description
Always Off	The backlighting of the device is always switched off.
Always On	The backlighting of the device is always switched on.
Status display (on/up/down at 1)	The backlighting of the device is always switched on with an on, up or down command.

Table 6: Function of the backlighting

Switch off device LEDs

With this function, it is possible to switch off all RGB status LEDs and the backlighting of the device with a command from a time switch, another push button or a brightness sensor, e.g. at night.

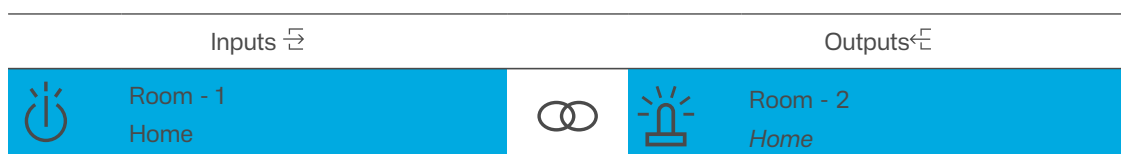

Table 7: Switching off the status LED/backlighting

	Room - 2 Home	
-----------------------------------------------------------------------------------	------------------	--

Table 7: Switching off the status LED/backlighting

5 Independent push-button configuration

This chapter describes the configuration of the independent push button. Only the first pair of independent push buttons is described. Additional independent push buttons must be configured accordingly. The functions of the button/input are divided into the following function groups.

Function
› No function
› Lighting
› Dimming
› Roller shutter
› Heating/cooling
› Audio

Table 8: Function selection of the independent push button

The No function[Ⓢ] function is preset at the beginning of the parameterisation. This means that the relevant button/input is not active.

The **Lighting, Dimming, Roller shutter, Heating/cooling and Audio** functions have different sub-functions, which are described in the following sections.

Parameter	Description	Value
No function	The input has no function (inactive).	
Lighting	This parameter sets the function of the independent push-button under Lighting .	On Off Switching (push-button function) Toggle switch Timer Priority On (toggle) Priority Off (toggle) Master on Master off Scene Automatic control deactivation toggle
Dimming	This parameter sets the function of the independent push-button under Dimming .	Dimming up (on) Dimming down (off) Dimming Up/Down Dimming Colour temperature colder Colour temperature warmer Colour scrolling forwards

Table 9: Function of the button

Parameter	Description	Value
		<ul style="list-style-type: none"> Colour scrolling backwards Scene Automatic control deactivation toggle
Roller shutter	This parameter sets the function of the independent push-button under Roller shutter .	<ul style="list-style-type: none"> Blind open Blind up Roller shutter up Roller shutter down Position shutter Slat angle Position roller shutter and slat Priority Up toggle Priority Down toggle Master control Up Master control Down Scene Automatic control deactivation toggle
Heating/cooling	This parameter sets the function of the independent push-button under Heating/cooling .	<ul style="list-style-type: none"> Comfort mode Eco mode Standby mode Protection mode Setpoint Offset Priority Comfort toggle Priority Protection toggle Heating/cooling toggle HVAC mode switch Increase the setpoint value Decrease the setpoint value Scene Automatic control deactivation toggle
Audio	This parameter sets the function of the independent push-button under Audio .	<ul style="list-style-type: none"> Audio on Audio off Audio On Off Loudness + Loudness - Audio Favorite Scene Automatic control deactivation toggle

Table 9: Function of the button

5.1 Lighting functions

The 'Lighting' function is used to switch the lighting or socket circuits on/off with a switching actuator.

Function	
On	Priority On toggle
Off	Priority Off toggle
Switching	Master on
Toggle switch	Master off
Timer	Scene
	Automatic control deactivation toggle

Table 10: Function selection of the independent push button



All of the combination possibilities between inputs - outputs/inputs are listed at the end of the chapter.

- Functions on/ off

The **On/Off** functions are used to control the lighting and socket circuits. The two adjacent buttons/inputs should be parameterised with the functions Lighting **On** and Lighting **Off** so that the lighting can be switched on and off by a device.

5.1.1 Function on /off

The **On/Off** functions are used to control the lighting and socket circuits. The two adjacent buttons/inputs should be parameterised with the functions Lighting **On** and Lighting **Off** so that the lighting can be switched on and off by a key.

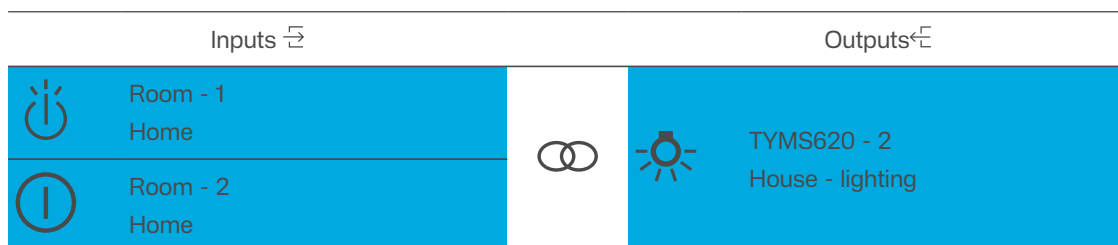

Table 11: Linking function On - Off

5.1.2 Switching function (buttons)

Pressing the button switches on the switch actuator channel and releasing the button switches it off again (push-button function). The function can be used to switch on an installation contactor/self-retaining relay, for example (conventionally wired stairway timer or bell push-button).



Inputs ↗	↘	Outputs ↙
 Room - 2 Home		 TYMS620 - 2 House - lighting

Table 12: Linking switching function

5.1.3 'Toggle switch' function

The 'Toggle switch' function means changing over. When the 'Toggle switch' function is active, pressing the same independent push button triggers an alternate switching command.



Inputs ↗	↘	Outputs ↙
 Room - 1 Home		 TYMS620 - 2 House - lighting

Table 13: Linking Toggle switch function

5.1.4 Timer function

In the Timer function, when a short key-press occurs, the corresponding switch output is switched for the time set in the switching actuator. When a long key-press occurs, the ongoing timer operation is interrupted and the switch output is switched off.



Inputs ↗	↘	Outputs ↙
 Room - 1 Home		 TYMS620 - 2 House - lighting

Table 14: Linking Timer function

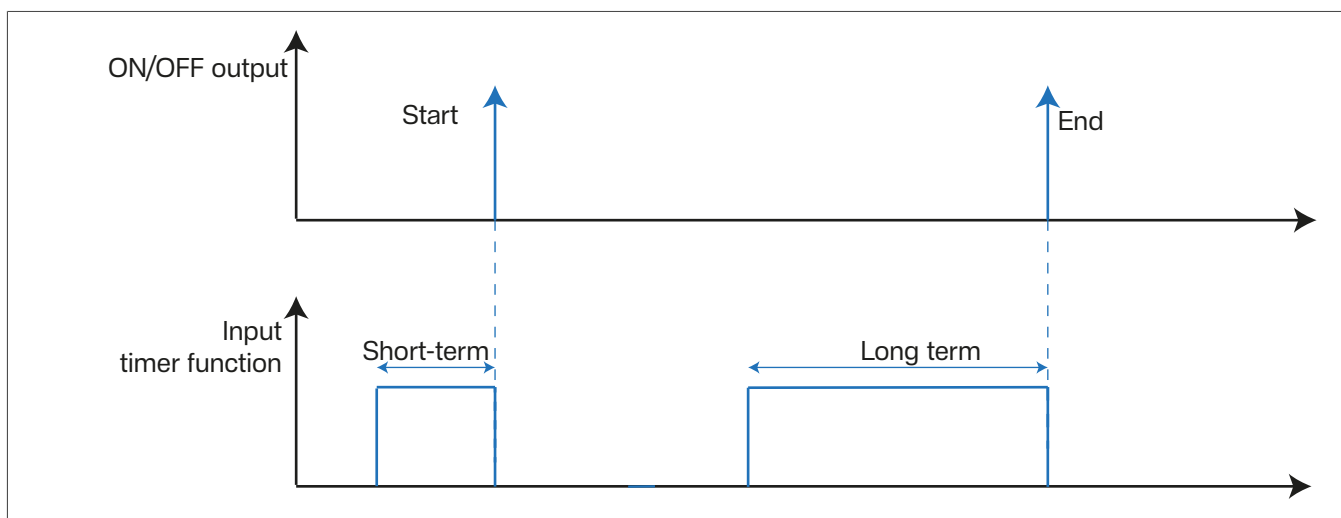

Fig. 12: Signal-time diagram for timer

5.1.5 Master ON/OFF function

Inputs ↗	↘	Outputs ↙

Table 15: Linking function Master On/Off

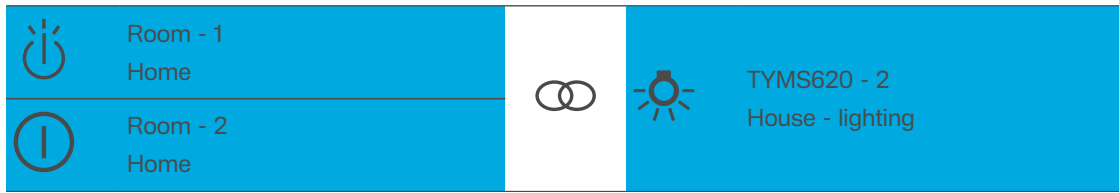

Table 15: Linking function Master On/Off

5.1.6 Priority On/Off toggle function

This function allows a switch output to be forced to a switch position regardless of the switching signal (higher priority). As a result, the Priority can be switched on/off with the same button (toggle).

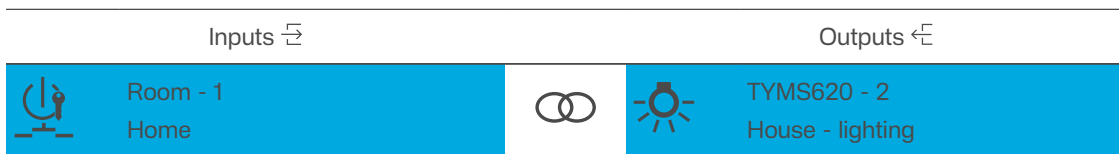

Table 16: Linking Priority on toggle function

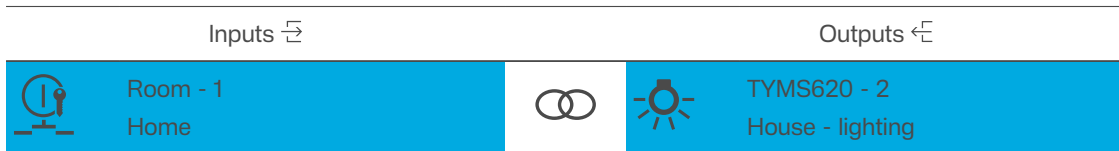

Table 17: Linking Priority off toggle function

When 'Priority' is active, incoming switch telegrams are still evaluated and the parameters set in the switch output are executed when 'Priority' is not active.

A 'Priority' function activated before a bus voltage failure is always deactivated after a bus voltage recovery. The effect of Priority depends on the linked actuator channel

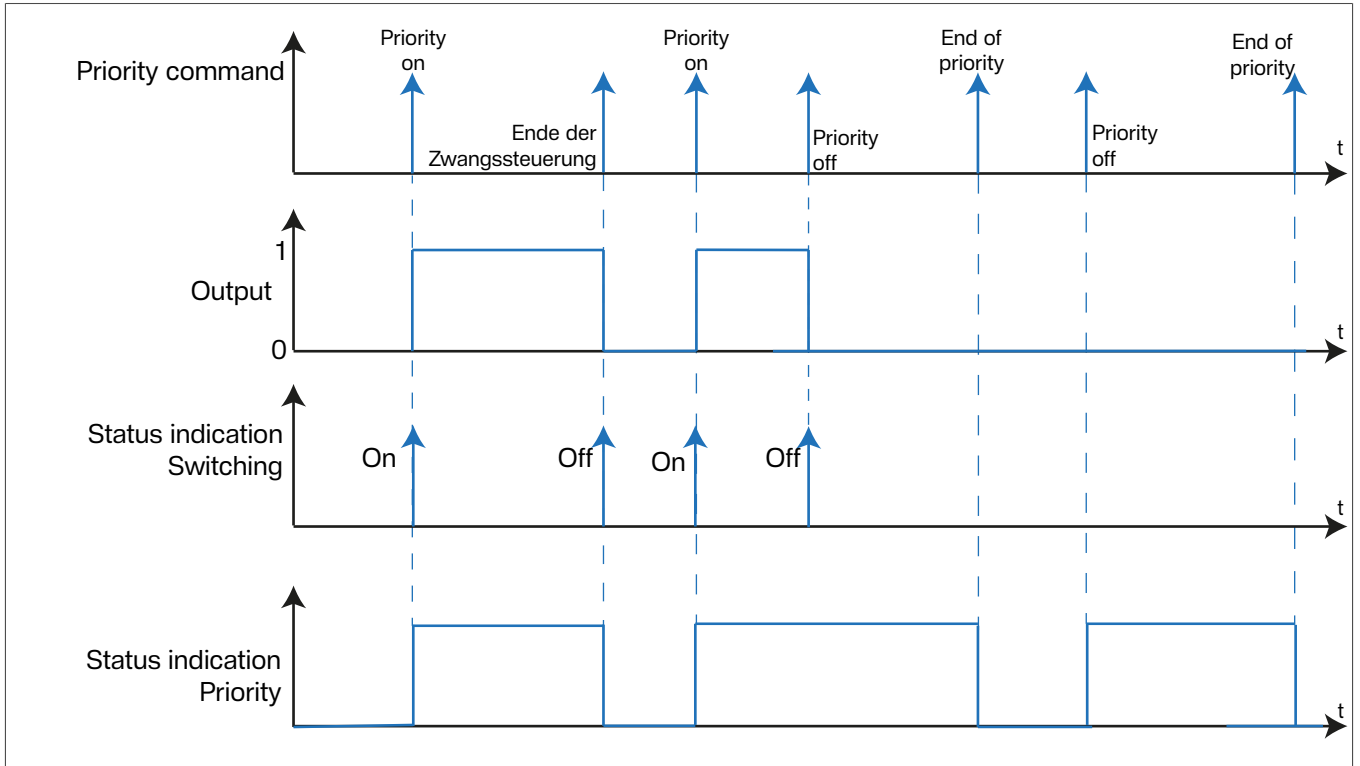

Fig. 13: Signal-time diagram for Priority

Example: Locking motion detector

The **Locking motion detector** function is an application which prevents the motion detector from switching the lighting on/off constantly during an event, for example. As a result, the motion detector operation is disabled from a central point. The motion detector function is also enabled from a central point.

5.1.7 Scene function

The **Scene** function can be used as a scene extension unit and can be used to call up or save configured light scenes that are stored in other KNX devices. The device can call up and save a maximum of 8 scenes. Through a short key-press, the device transmits a value between 0 and 7 (where value 0 corresponds to scene 1 and value 7 corresponds to scene 8) to the bus. The scene is called up when the button is released.

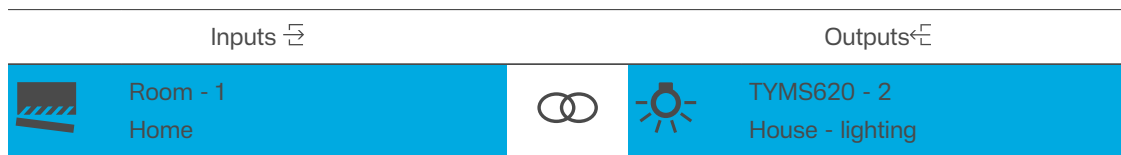

Table 18: Linking Scene function

After selecting the Scene function, an additional menu field opens to determine the scene number. A scene between 1 and 8 can be entered here.

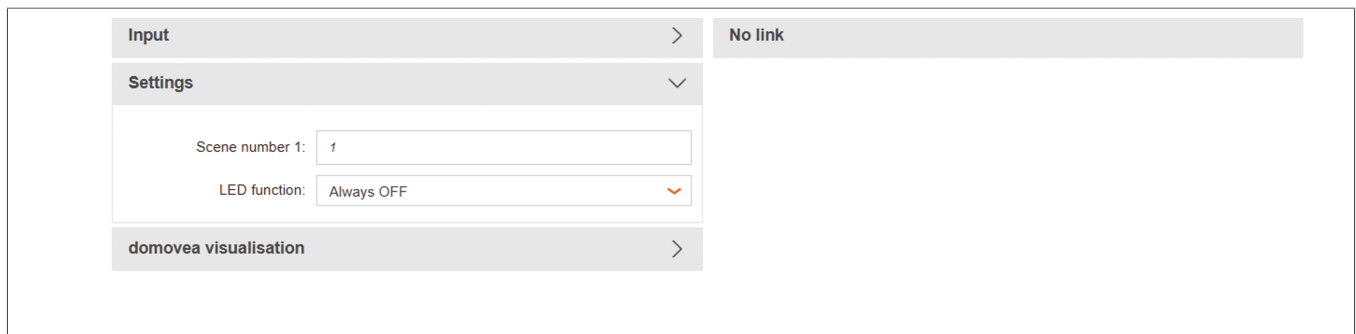

Fig. 14: Entering the scene number

The related scene parameter values can be changed with the corresponding operating sections and stored with a long button press.

Example: Scene TV

In the Scene TV example, the typical scene values are changed and then the scene is saved again.

- 1 Switch on scene using a short press of the button **A**.
Scene is activated e.g., lighting dimmed to 30%, blinds closed to 85%.
- 2 Set new scene parameters on the push button **B**.

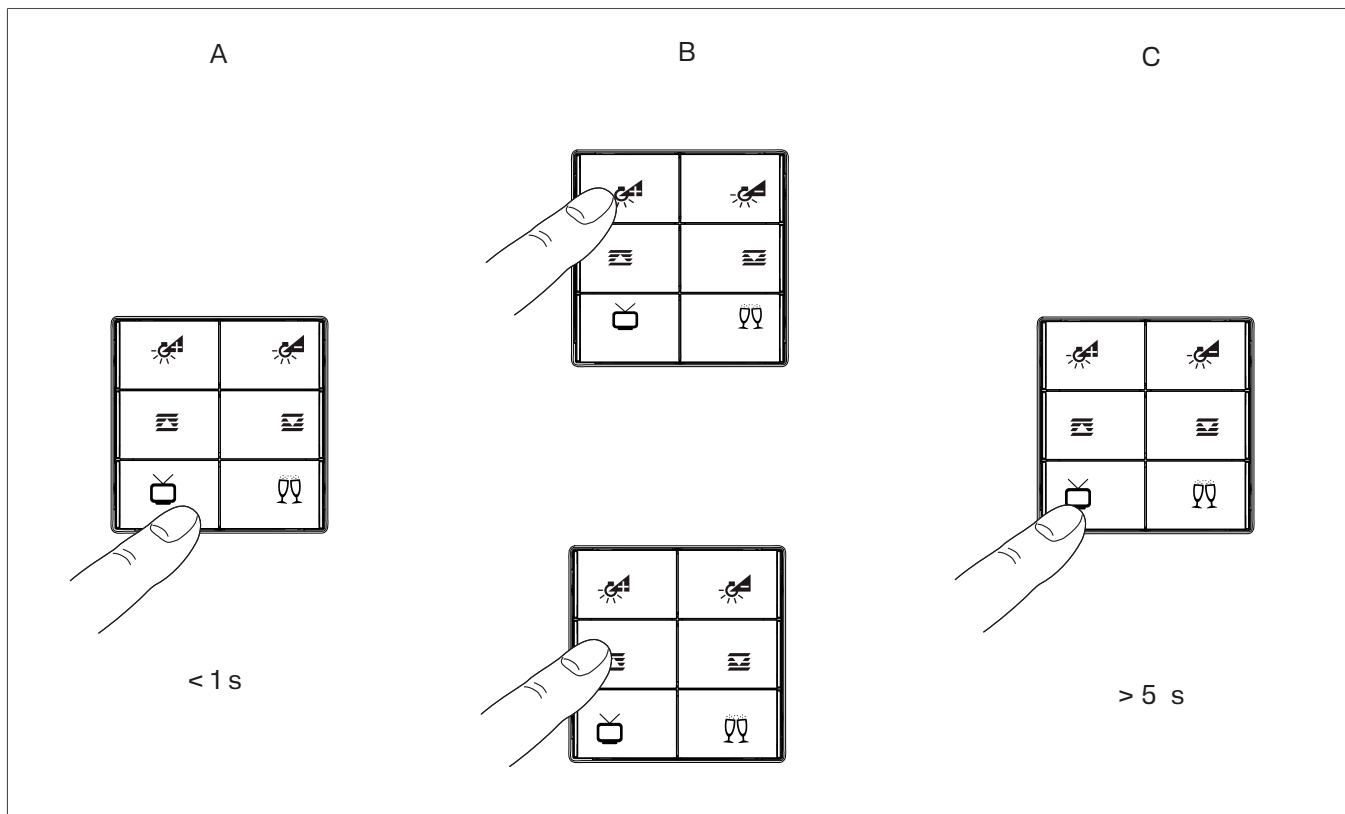

Fig. 15: Scene call-up

- Change lighting brightness, dim up or down, change blind position.
- Hold the button for Scene TV for longer than 5s .

New scene parameters have been saved. Pressing the button again activates the new scene settings.

The Save scene by a long press of the button function is switched on by default.

5.1.8 Automatic control deactivation toggle

With this function, it is possible to deactivate and activate the automatic functions in the actuators which are already running (Toggle mode).

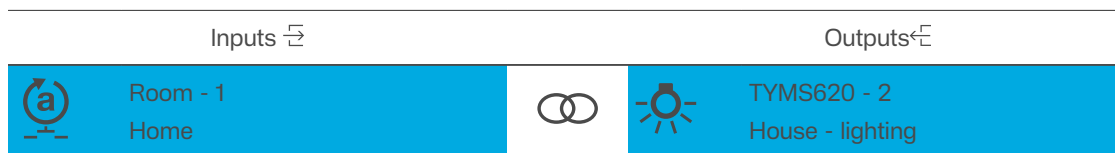

Table 19: Linking Automatic control deactivation toggle function

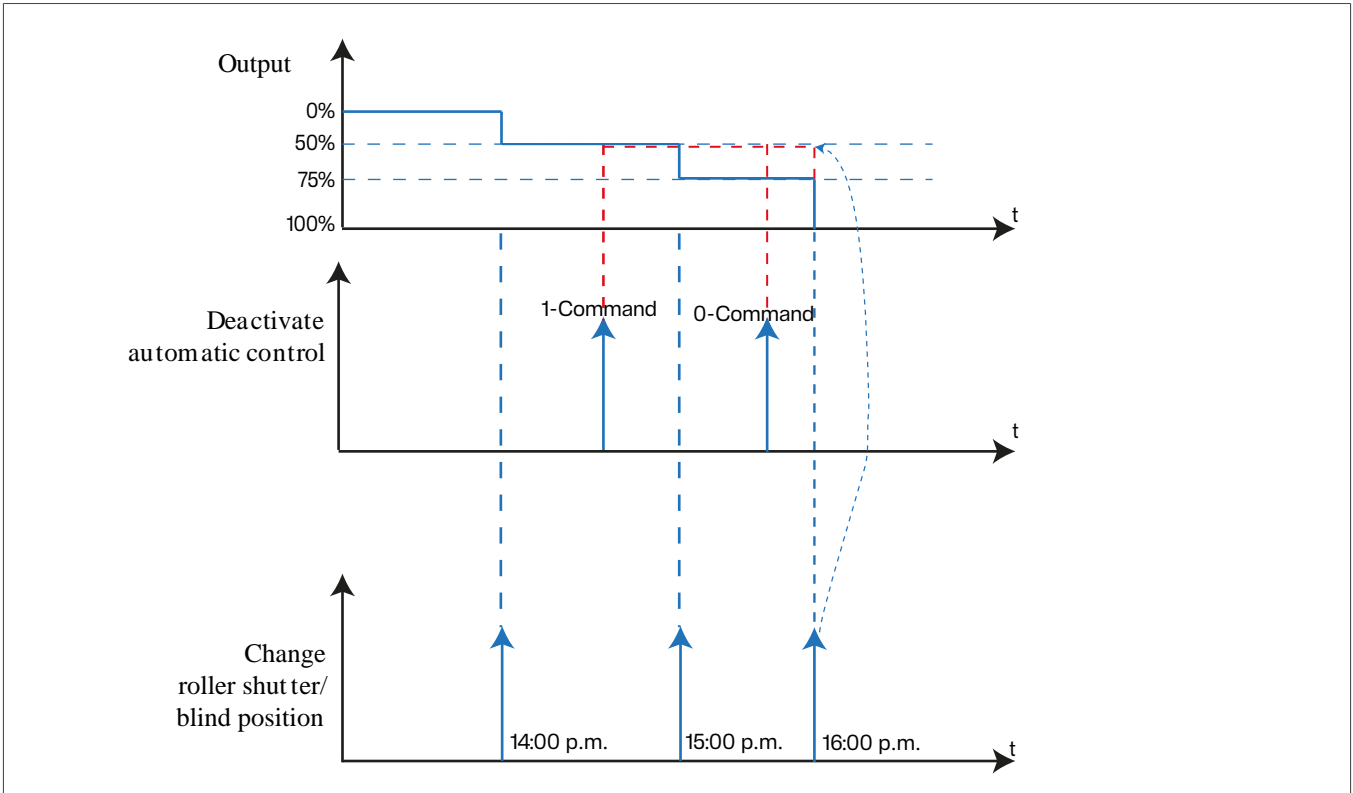

Fig. 16: Signal-time diagram for Automatic control deactivation

Example: Shading control using position of sun

The shading control should move the blind up and down depending on the position of the sun. In the example (Fig. 56), the blind is moved to different positions at 2 p.m., 3 p.m. and 4 p.m. Between 2 p.m. and 3 p.m. (1), the button with the **Deactivate automatic control** function is pressed. As a result, the blind position for 3 p.m. is not carried out, but remains in the 2 p.m. position. Between 3 p.m. and 4 p.m. (2), the button with the **Deactivate automatic control** function is pressed again (toggle operation). The Deactivate automatic control function is now switched off and the blind moves into the corresponding position at 4 p.m.

5.1.9 Overview of all possible linking combinations

The following overview shows all linking combination possibilities for the **Lighting** function. It is worth noting that inputs can also be linked with inputs (depending on the function selection).

Linking	
Input	Output
	Orientation/labelling field illumination
	ON/OFF output
	Dimming output

Table 20: Combination possibilities Lighting input - output

			 Logic function
			 Fan-Coil output
			 Orientation/labelling field illumination
			 ON/OFF output
	Room - 1 Home		 Dimming output
			 Logic function
			 Fan-Coil output
			 Orientation/labelling field illumination
			 ON/OFF output
	Room - 1 Home		 Dimming output
			 Logic function
			 Fan-Coil output
			 Orientation/labelling field illumination
			 ON/OFF output
	Room - 1 Home		 Dimming output
			 Logic function
			 Fan-Coil output
			 ON/OFF output
	Room - 1 Home		 Dimming output

Table 20: Combination possibilities Lighting input – output

Independent push-button configuration

Lighting functions











				Fan-Coil output
				ON/OFF output
	Room - 1 Home			Dimming output
				Fan-Coil output
				ON/OFF output
	Room - 1 Home			Dimming output
				Fan-Coil output

Table 20: Combination possibilities Lighting input – output

Linking



































Input 		Linking 	Output 
 Room - 1 Home			 ON/OFF output <hr/>  Dimming output
 Room - 1 Home			 ON/OFF output <hr/>  Dimming output
 Room - 1 Home			 ON/OFF output <hr/>  Dimming output
 Room - 1 Home			 ON/OFF output <hr/>  Dimming output
 Room - 1 Home			 ON/OFF output
 Room - 1 Home			 ON/OFF output <hr/>  Dimming output
 Room - 1 Home			 ON/OFF output <hr/>  Dimming output
 Room - 1 Home			 ON/OFF output <hr/>  Dimming output

Table 21: Combination possibilities Lighting input – output

5.2 Dimming functions

The lighting can be switched on/off (short press of button) and dimmed brighter, darker (long press of button) with the **Dimming** function.

Dimming	
Dimming up (on)	Colour temperature colder
Dimming down (off)	Colour scrolling forwards
Dimming Up/Down	Colour scrolling backwards
Dimming	Scene
Colour temperature warmer	Automatic control deactivation toggle

Table 22: Overview of dimming functions



All functions from the **Lighting** function group can be linked with a dimming output. Only the relevant **switching command** is executed.

5.2.1 Dimming Up (On)/Down (Off) functions

With the Dimming up (on)/down (off) functions, dimmable lights/lamps are switched on/off with a short press of the button and dimmed up or down with a long press of the button. This means that two buttons are needed for dimming. One button for Dimming up (on) and the second button for Dimming down (off).

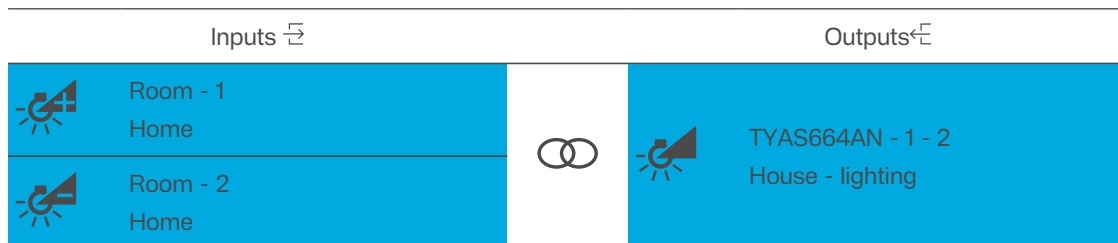

Table 23: Linking Dimming up (on)/down (off) function

5.2.2 Dimming Up/Down functions

With this function, the lighting can be switched on/off with a short press of the button and dimmed up/down with a long press of the same button (toggle).

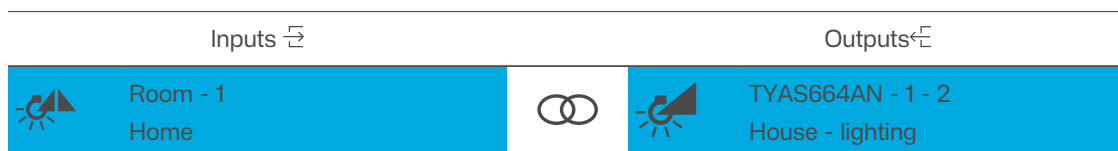

Table 24: Linking Dimming up/down function

5.2.3 Dimming function

When the **Dimming - dimming value** function is selected, the lighting is switched on at a fixed dimming value set previously. The dimming value is entered in an additional menu field as a whole number.

The range for the dimming value is between 0 % and 100 %. The **Dimming – dimming value** function assigns a specific brightness value to the lamp via the connected actuator.

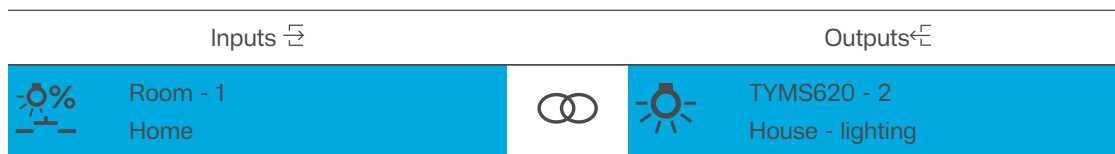

Table 25: Linking Dimming – dimming value function

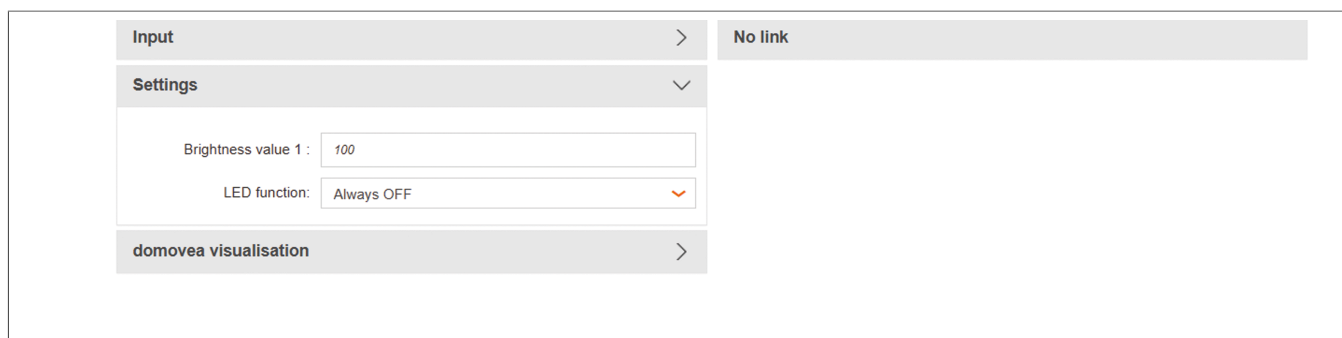

Fig. 17: Set dimming value

5.2.4 Colour temperature colder/warmer

General

The product supports the control of DALI devices of the type ‘Colour Control’ (DALI Device Type 8). The use of DALI devices and suitable light sources makes it possible to control the colour of an RGBW LED luminaire.

The Colour temperature colder function allows the colour temperature to be reduced.

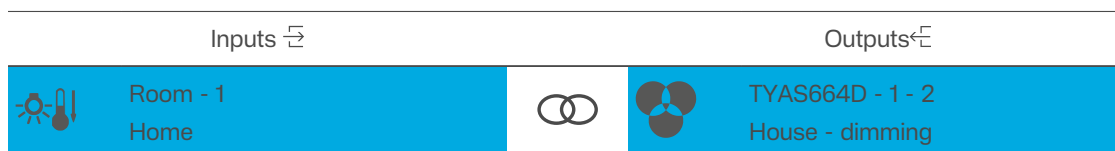

Table 26: Linking Colour temperature colder function

The Colour temperature warmer function allows the colour temperature to be increased.

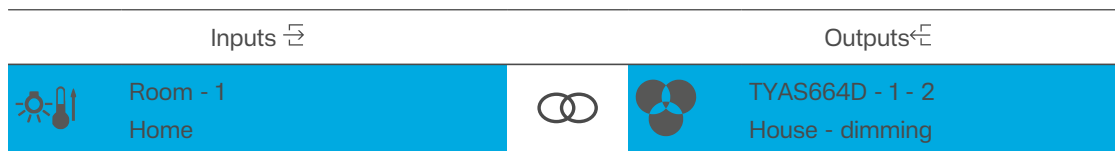

Table 27: Linking Colour temperature warmer function

5.2.5 Colour scrolling forwards/backwards

The product supports the control of DALI devices of the type ‘Colour Control’ (DALI Device Type 8). The use of DALI devices and suitable light sources makes it possible to control the colour of an RGBW LED.

Colour scrolling allows a colour to be selected from a predefined set of colours. With each button press, a new colour is set in a clockwise direction. The colour sequence is shown in the illustration.

In addition to the colour white, the available colour set is structured as follows:

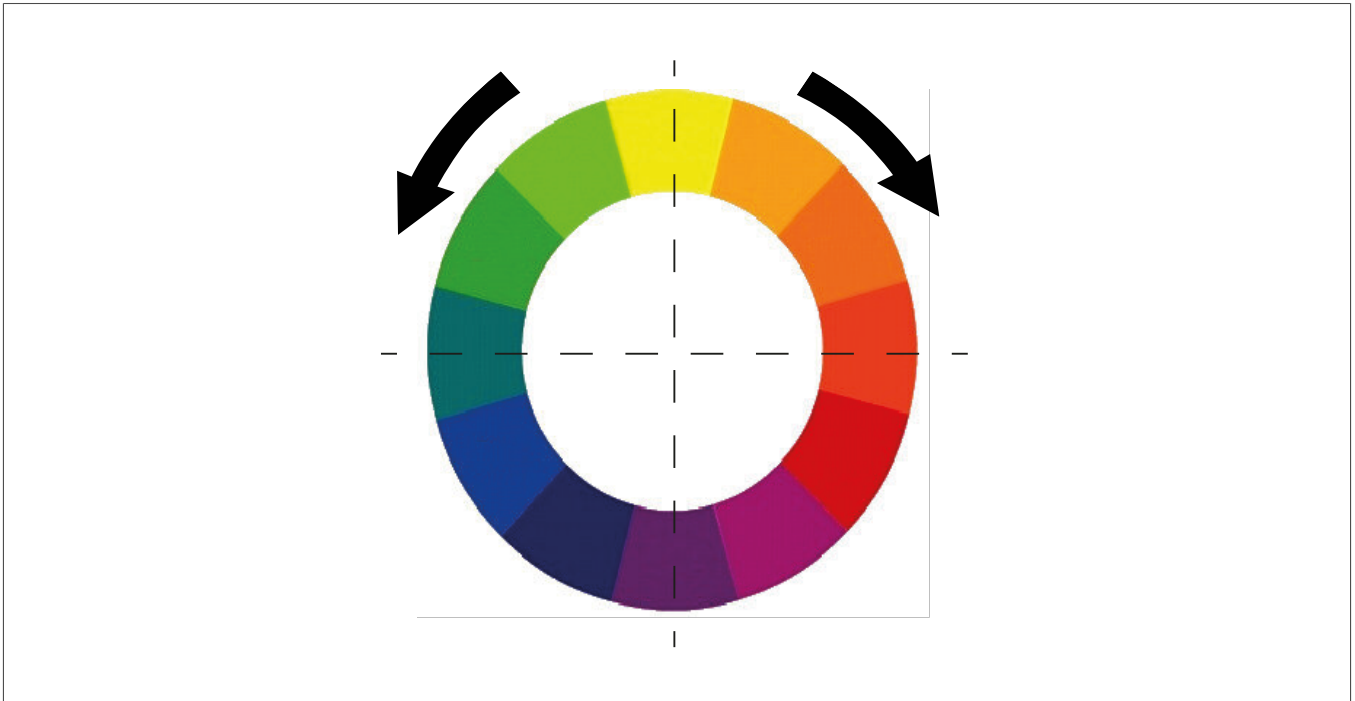

Fig. 18: Colour temperature diagram

Colour scrolling forwards causes the colours to change in a clockwise direction.

Inputs ↔	↔	Outputs ←
Room - 1 Home		TYAS664D - 1 - 2 House - lighting

Table 28: Linking Colour scrolling forwards function

Colour scrolling backwards causes the colours to change in an anti-clockwise direction.

Inputs ↔	↔	Outputs ←
Room - 1 Home		TYAS664D - 1 - 2 House - lighting

Table 29: Linking Colour scrolling backwards function

5.2.6 Scene function

The detailed description of the Scene function can be found in Chapter [see "Scene function", page 32](#).

5.2.7 Automatic control deactivation toggle

The detailed description of the **deactivate automatic control toggle** function can be found in chapter [see "Automatic control deactivation toggle", page 33](#).

5.2.8 Overview of all possible linking combinations

The following overview shows all linking combination possibilities for the **Dimming** function. It is worth noting that inputs can also be linked with inputs (depending on the function selection).

Linking













































Input 			Output 
 Room - 1 Home			 ON/OFF output <hr/>  Dimming output
 Room - 1 Home			 ON/OFF output <hr/>  Dimming output
 Room - 1 Home			 ON/OFF output <hr/>  Dimming output
 Room - 1 Home			 ON/OFF output <hr/>  Dimming output
 Room - 1 Home			 ON/OFF output <hr/>  Dimming output
 Room - 1 Home			 Dimming output
 Room - 1 Home			 ON/OFF output <hr/>  Dimming output
 Room - 1 Home			 Dimming output
 Room - 1 Home			 Dimming output
 Room - 1 Home			 Dimming output
 Room - 1 Home			 Dimming output / colour temperature
 Room - 1			 Dimming output / colour temperature

Table 30: Combination possibilities Dimming input – output

Independent push-button configuration

Dimming functions

Home			
	Room - 1 Home		 Dimming output / colour temperature
	Room - 1 Home		 Dimming output / colour temperature

Table 30: Combination possibilities Dimming input – output

5.3 Roller shutter function

The **Roller shutter** function for the buttons/inputs is configured in the following parameter windows.

This function is used for activating roller shutters, blinds, awnings and other hangings. With the Roller shutter and Blind functions, a distinction is made between a long and short button press.

Roller shutter function

- Short button press: Step-by-step motion command up/down or stop command
- Long button press: Motion command (up/down)

Function blind

- Short button press: Motion command for step-by-step up/down, slat step, adjustment of the slat angle or stop command
- Long button press: Motion command (up/down)













Function	
 Blinds open	 Priority Up toggle
 Blinds up	 Priority Down toggle
 Roller shutter up	 Master control Up
 Roller shutter down	 Master control Down
 Position shutter	 Scene
 Slat angle	 Automatic control deactivation toggle
 Position roller shutter and slat	

Table 31: Roller shutter function selection

5.3.1 Basics of roller shutter/blind control

For roller shutter/blind drives with final position switches, the position of the roller shutter/blind can be brought into the correct position by specifying a percentage value. The following settings must be observed.

For blind drives, a distinction is also made between slats arranged horizontally and vertically.

Slat adjustment for slats arranged horizontally

The top final position of the roller shutter/blinds is set using the value 0% and returned as a status value.

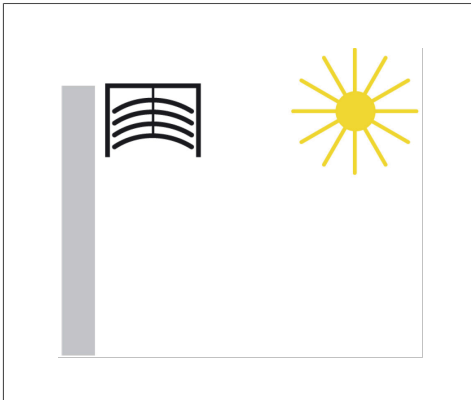

Function position in %

- Sun protection completely open
- Top final position reached 0 %

Fig. 19: Blind position top final position 0%

The bottom final position of the roller shutter/blinds is set using the value 100% and returned as a status value.

If a blind drive is moved from the top final position into the lower final position, then the slats will initially tilt into a nearly vertical position and the blind will move with closed slats until it reaches the bottom final position.

If a blind is in the bottom final position and the slats are fully closed, then this slat position is identified as vertical and 100 %. However, the fully closed slats cannot be exactly vertical ($\alpha = 180^\circ$); instead, they are at a slight angle from the vertical.

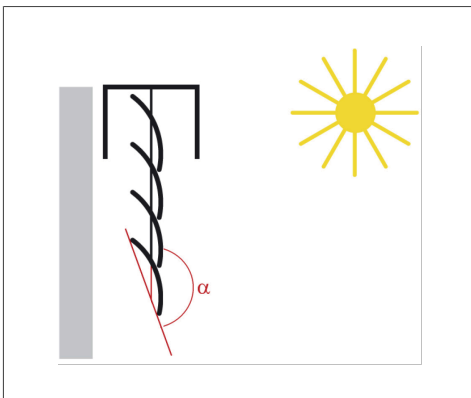

Function position in %

- Sun protection completely closed
- Bottom final position reached 100 %

Fig. 20: Blind position bottom final position

If the blind is set into motion from the vertical position (bottom end position, 100 % fully closed), the slats move into the horizontal position ($\alpha = 90^\circ$). With the slat adjustment function, it is possible determine the number of steps so that the slats can be adjusted almost infinitely.

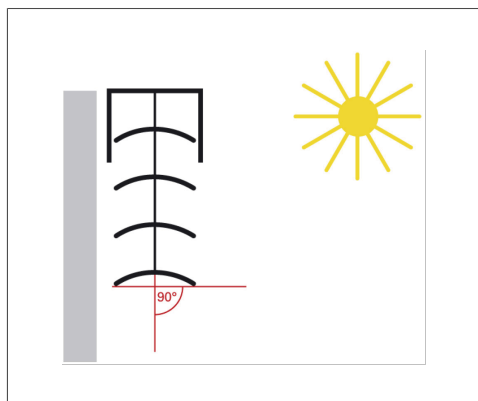

Slat angle in %

- Slat position horizontal ($\alpha = 90^\circ$)

Fig. 21: Adjust slat angle

With blinds, the position of the slats can be adjusted beyond the horizontal position until they have reached the maximum point to which they can be adjusted and the blind starts moving towards the top final position. The slat angle can therefore adopt a value between 0 and 90° .

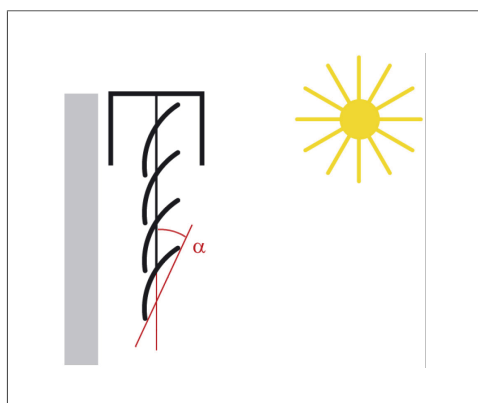

Slat angle in %

- Slat position at the start of the movement towards the top final position

Fig. 22: Slat angle at the start of the movement towards the top final position

Slat adjustment for slats arranged vertically

When there is shade or screen with slats arranged vertically, the shade behaves like slats arranged horizontally. As a result, when the slats are fully open, the value 0 % is transmitted and returned as a status value. The slats therefore form an angle of $\alpha = 90^\circ$ the fully open shade to the fully closed shade.

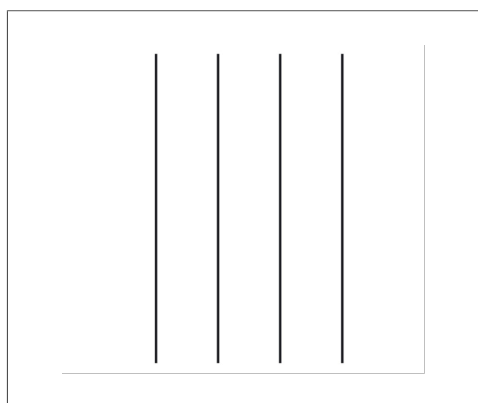

Slat angle in %

- Fully open slats arranged vertically $\alpha = 90^\circ$

Fig. 23: Slat angle for slats arranged vertically $\alpha = 90^\circ$

Fully closed slats are operated with a value of 100 %, which is also returned as a status. The angle which the slat forms with the direction of travel is approximately 0°.

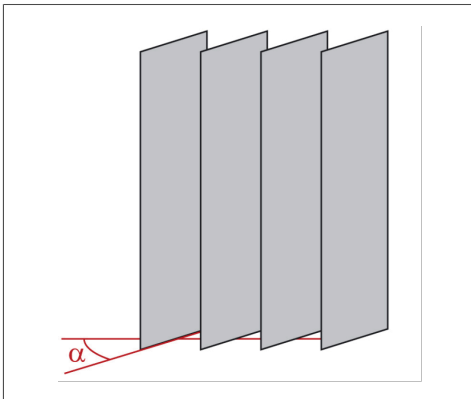

Fig. 24: Slat angle for slats arranged vertically $\alpha \approx 0^\circ$

Slat angle in %

- Fully closed slats arranged vertically $\alpha \approx 0^\circ$

If the shade is open, the slats turn into a position at an angle a little less than 180°.

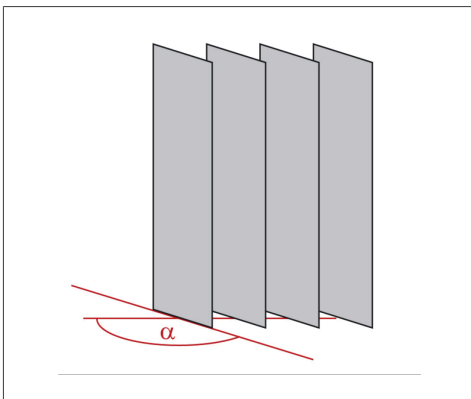

Fig. 25: Slat angle when opening $\alpha \approx 180^\circ$

Slat angle in %

- Slats arranged vertically when opening $\alpha \approx 180^\circ$

5.3.2 Functions blinds up / blinds down

If the button/input is assigned the Blind up/down function, the blinds can then be moved up and down. A motion command is transmitted to the actuator if the button is pressed for a long time and a stop command is transmitted if the button is pressed for a short time.

Further information, e.g. operating mode, running time to top/bottom final position, can be found in the application description for the respective roller shutter/blind output.

Inputs		Outputs	
	Room - 1 Home		TYAS610 - 2 House - lighting
	Room - 2 Home		

Table 32: Linking Blinds up/down function



Further information, e.g. operating mode, running time to top/bottom final position, can be found in the application description for the respective roller shutter/blind output.

5.3.3 Roller shutter position function

A short press on the button configured with the **Roller shutter position** function moves the roller shutter output in switching mode until it reaches the desired position between 0 and 100%.

- 0%: top final position reached, roller shutter/blind is open
- 100%: bottom final position reached, roller shutter/blind is closed

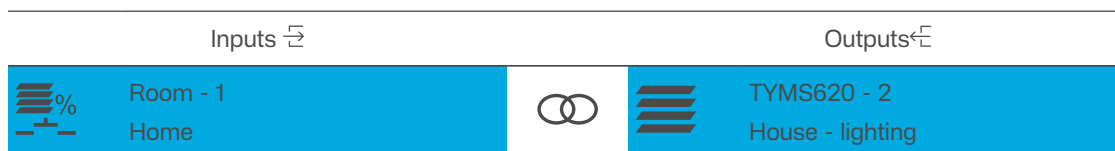

Table 33: Linking Roller shutter position function

Input >	No link
Settings v	
Position (0-100%): <input type="text" value="100"/>	
LED function: <input type="text" value="Status indication (On/Up/Down by 1)"/>	
domovea visualisation >	

Fig. 26: Entering the roller shutter position between 0 and 100 %

5.3.4 Function slat angle

A short press on the button configured with the **Slat angle** function switches on the blind output until it reaches the set slat angle 0–100%.

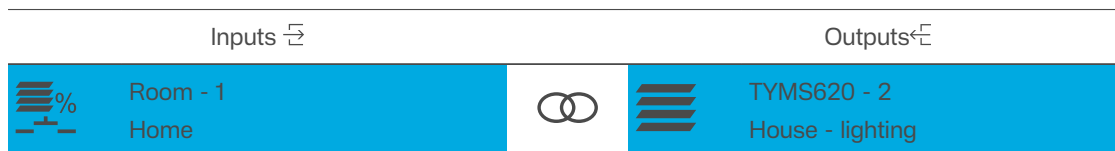

Table 34: Linking Slat angle function

Input >	No link
Settings v	
Slat angle (0-100%): <input type="text" value="100"/>	
LED function: <input type="text" value="Always OFF"/>	
domovea visualisation >	

Fig. 27: Entering the slat angle 0 - 100 %

5.3.5 Functions Roller shutter and slat position

A short press on the button configured with the **Roller shutter and slat position** function switches the roller shutter/blind output on until it reaches the set slat angle between 0 and 100% and the position between 0 and 100%.

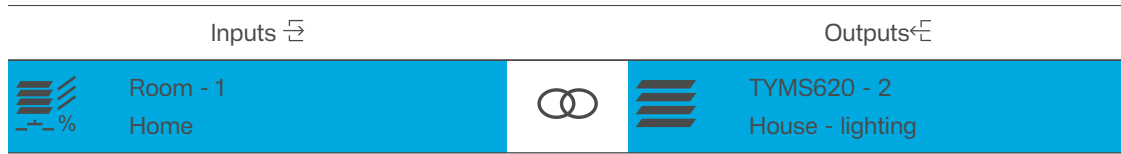

Table 35: Linking Roller shutter and slat position function

Input >	No link
Settings v	
Position (0-100%):	<input type="text" value="100"/>
Slat angle (0-100%):	<input type="text" value="100"/>
LED function:	Status indication (On/Up/Down by 1) v
domovea visualisation >	

Fig. 28: Entering the position/slat angle 0 - 100 %

5.3.6 Functions roller shutter up / roller shutter down

If the button/input is assigned the **Roller shutter up/down** function, the roller shutters can therefore be moved up and down. A motion command is transmitted to the output if the button is pressed for a long time and a stop command is transmitted if the button is pressed for a short time.

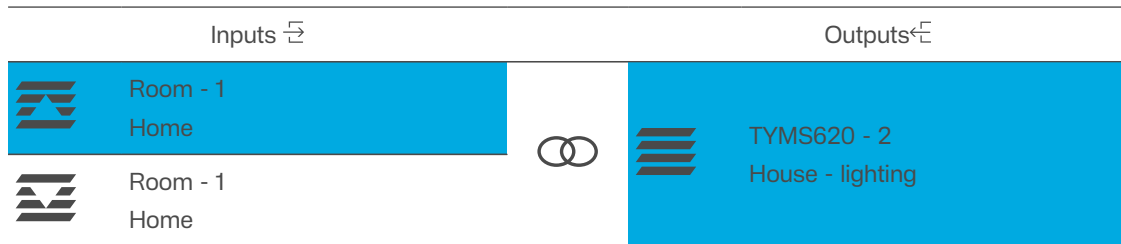

Table 36: Linking Roller shutter up/down function

	Further information, e.g. operating mode, running time to top/bottom final position, can be found in the settings for the respective roller shutter/blind output.
--	-------------------------------------------------------------------------------------------------------------------------------------------------------------------

5.3.7 Priority up toggle/down toggle functions

The **Priority** function allows a roller shutter/blind output to be forced to a switch position by a telegram regardless of a switching command (higher priority). As a result, the Priority can be switched on/off with the same button (toggle).

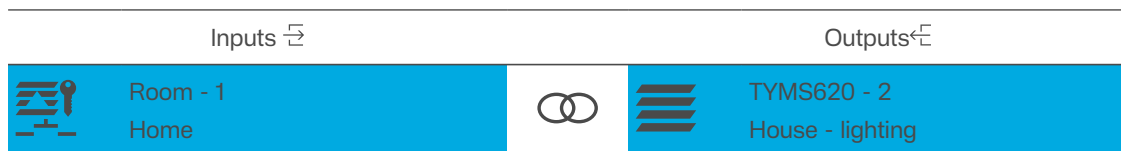

Table 37: Linking Priority up toggle function



Table 38: Linking Priority down toggle function



Table 38: Linking Priority down toggle function

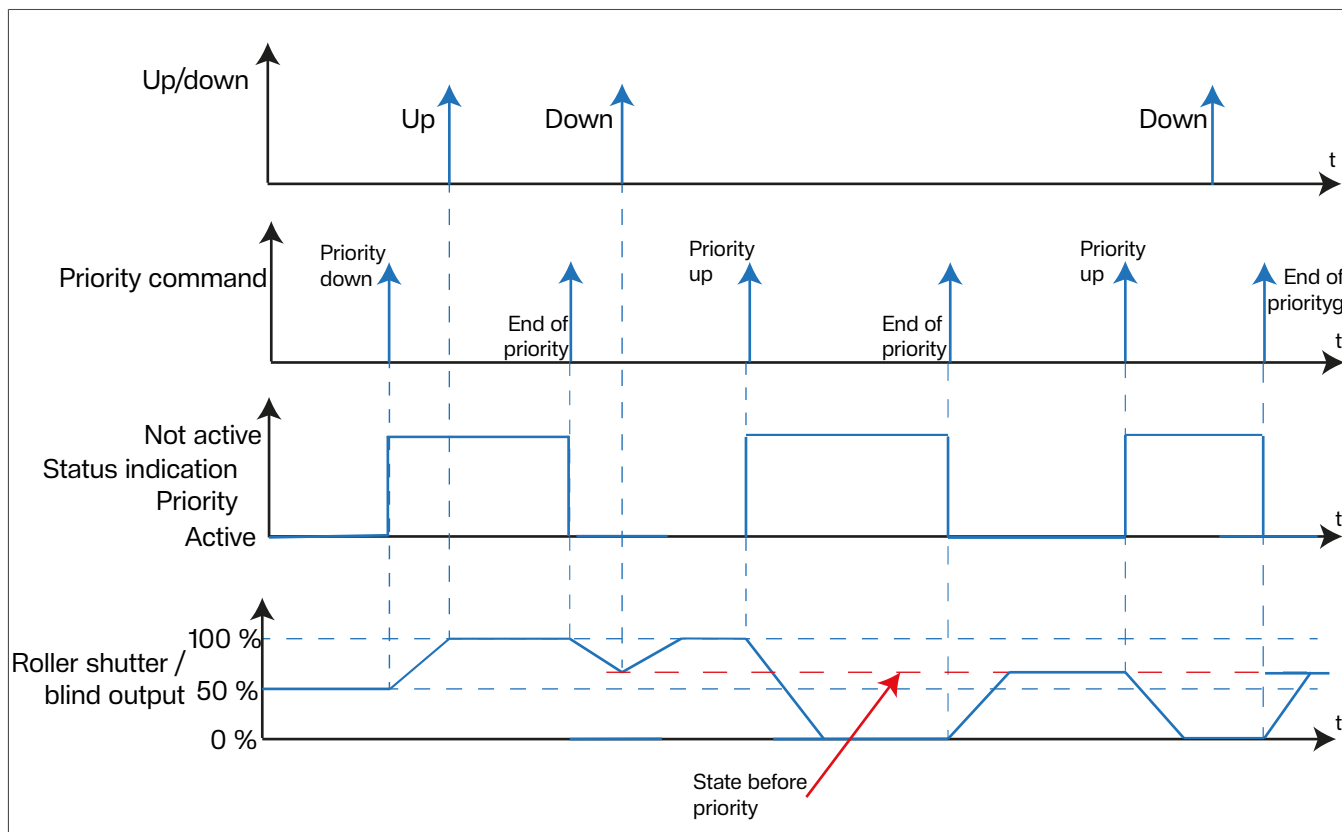

Fig. 29: Signal-time diagram for Priority roller shutter/blind

The value of the telegram is defined according to the following syntax:

When 'Priority' is active, incoming switch telegrams are still evaluated internally; when 'Priority' is no longer active, the current switching state is set.

A 'Priority' function activated before a bus voltage failure is always deactivated after a bus voltage recovery. The effect of the 'Priority' function depends on the actuator channel connected (lighting, shutter/blind, heating).

Example: Window cleaner function

The window cleaner function is an application that prevents a manual operation of the blind/roller shutter from being executed during the window cleaning. As a result, the blind/roller shutter operation is disabled from a central point. Blinds that have already been lowered are moved to the upper stop position. The manual blind/roller shutter function is also enabled from a central point.

5.3.8 Master up/Master down

With the Master Up/Down function, it is possible to open or close a group of roller shutters or blinds. In contrast to the Up/Down function, the status indicator of the controlled outputs is not transmitted. This prevents overloading of the KNX bus when outputs are switched simultaneously. It is recommended to use this function when the number of roller shutter/blind outputs exceeds 20.

Master up:

Pressing the button starts **upwards movement** for a linked group of blinds and roller shutters simultaneously.

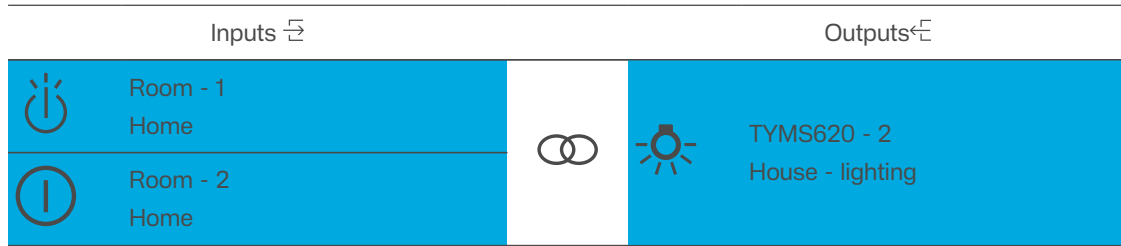

Table 39: Linking Master up function

Master down:

Pressing the button starts **downwards movement** for a linked group of blinds and roller shutters simultaneously.

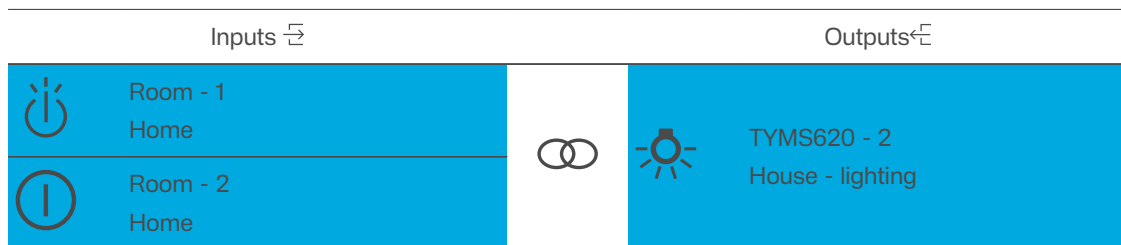

Table 40: Linking Master down function

5.3.9 Scene function

The detailed description of the Scene function can be found in Chapter [see "Scene function", page 32](#).

5.3.10 Automatic control deactivation toggle

With this function, it is possible to deactivate and activate the automatic functions in the actuators which are already running (Toggle mode).

The detailed description of the deactivate automatic control toggle function can be found in chapter [5.1.8 "Automatic control deactivation toggle", page 33](#).

5.3.11 Overview of all possible linking combinations

The following overview shows all linking combination possibilities for the **Roller shutter** function.

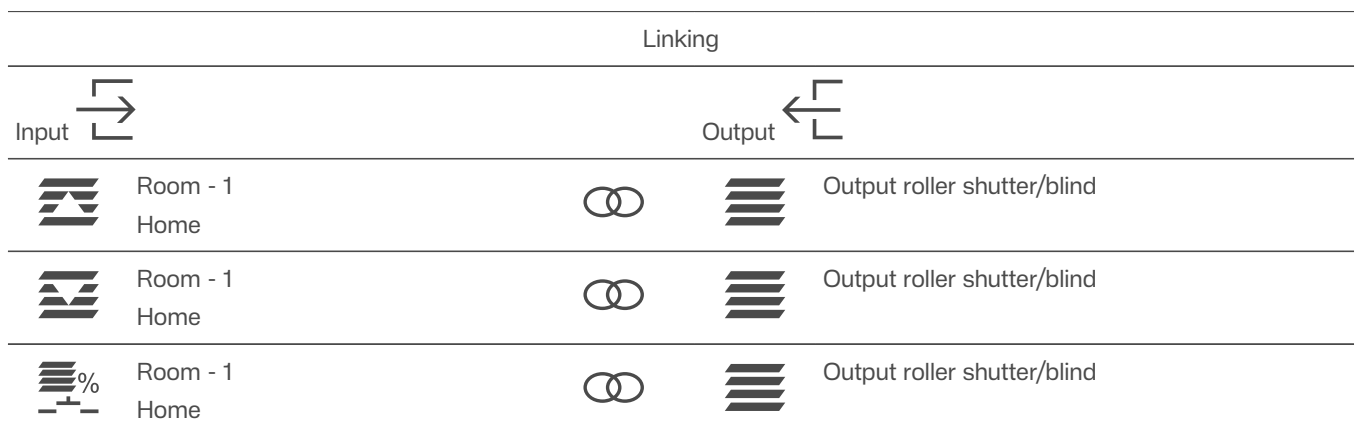

Table 41: Combination possibilities Roller shutter input – output

























































	Room - 1 Home			Output roller shutter/blind
	Room - 1 Home			Output roller shutter/blind
	Room - 1 Home			Output roller shutter/blind
	Room - 1 Home			Output roller shutter/blind
	Room - 1 Home			Output roller shutter/blind
	Room - 1 Home			Output roller shutter/blind
	Room - 1 Home			Output roller shutter/blind
	Room - 1 Home			Output roller shutter/blind
	Room - 1 Home			Output roller shutter/blind
	Room - 1 Home			Output roller shutter/blind
	Room - 1 Home			Output roller shutter/blind
	Room - 1 Home			Output roller shutter/blind
	Room - 1 Home			Output roller shutter/blind
	Room - 1 Home			Output roller shutter/blind
	Room - 1 Home			Output roller shutter/blind
	Room - 1 Home			Output roller shutter/blind
	Room - 1 Home			Output roller shutter/blind
	Room - 1 Home			Output roller shutter/blind
	Room - 1 Home			Output roller shutter/blind

Table 41: Combination possibilities Roller shutter input - output

Independent push-button configuration

Roller shutter function

	Room - 1 Home			Output roller shutter/blind
	Room - 1 Home			Output roller shutter/blind
	Room - 1 Home			Output roller shutter/blind
	Room - 1 Home			Output roller shutter/blind
	Room - 1 Home			Output roller shutter/blind
	Room - 1 Home			Output roller shutter/blind
	Room - 1 Home			Output roller shutter/blind
	Room - 1 Home			Output roller shutter/blind
	TXE530 - 1 - -1 Home			Output roller shutter/blind
	TXE530 - 1 - -1 Home			Output roller shutter/blind
	TXE530 - 1 - -1 Home			Output roller shutter/blind

Table 41: Combination possibilities Roller shutter input - output

5.4 Functions Heating/cooling

The **Heating/cooling** function allows an external KNX room thermostat to be activated using the push-button operation buttons.

This allows the user to change/adjust basic controller functions (such as operating mode change-over, setpoint selection, heating/cooling change-over) from different places in the room.



The room temperature controller extension unit, however, is not involved in actually controlling the temperature.

Function	
Comfort mode	Heating/cooling toggle
Eco mode	HVAC mode switch
Standby mode	Increase the setpoint value
Protection mode	Decrease the setpoint value
Setpoint Offset	Scene
Priority Comfort toggle	Automatic control deactivation toggle
Priority Protection toggle	

Table 42: Functional overview Heating/cooling

With the Comfort, Eco, Standby and Protection mode functions, the corresponding operating modes can be switched on in the associated thermostats or changed and transmitted to the bus by pressing a button.

Examples:

Comfort mode

- The **Comfort** operating mode sets the room temperature to a temperature value pre-defined in the thermostat (Comfort temperature 21°C, for example) when presence is detected.

Standby mode

- The **Standby** operating mode reduces the room temperature after leaving the room (brief absence) to a value e.g. 19°C predefined in the thermostat.

Eco mode

- The **Eco** operating mode turns down the room temperature during holiday time (during long absence) to a value of 17°C defined in the thermostat.

Protection mode

- The **Frost protection** operating mode reduces the heating circuit temperature to a minimum temperature of 7°C defined in the controller to protect against frost damage over night or during periods of extended absence.



With underfloor heating, the change-over from Comfort to Standby is only noticeable after a certain period of time due to the sluggishness of the underfloor heating system.

The function of the status LED can also be set for the **Comfort**, **Standby**, **Eco** and **Protection** modes. The LED can be set to **Always off**, **Always on** or can be used as a **thermostat**.

Status LED
Always Off
Always on
Status display (on/up/down at 1)

Table 43: Operating mode of status LED

5.4.1 Function Comfort mode

When the button is pressed, the device sets the room temperature to a temperature value predefined in the controller, e.g. a comfort temperature of 21°C, when presence is detected.

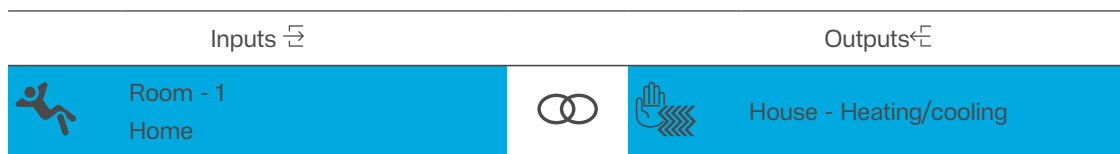

Table 44: Linking Comfort mode function

5.4.2 Function Standby mode

The device reduces the room temperature after leaving the room (brief absence) to a value predefined in the thermostat (19°C, for example).

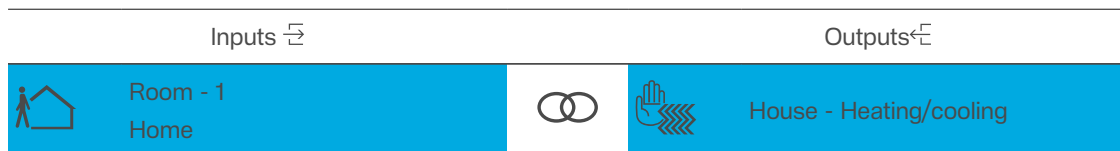

Table 45: Linking Standby mode function

5.4.3 Eco mode function

The device regulates the room temperature during holiday time (during long absence) to a value of 17°C defined in the thermostat.

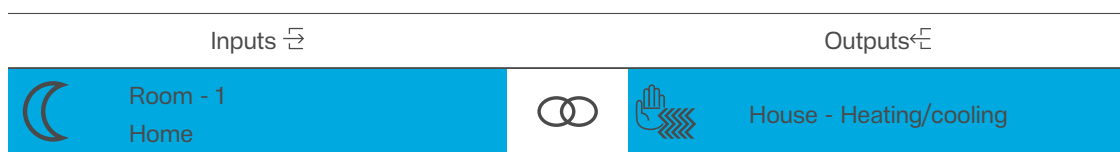

Table 46: Linking Eco mode function

5.4.4 Function Protection mode

The device reduces the heating circuit temperature to a minimum temperature of 7°C defined in the controller to protect against frost damage over night or during periods of extended absence.

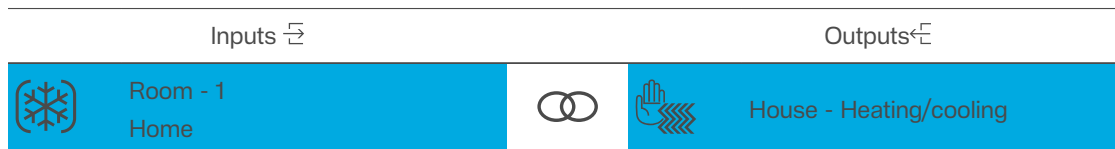

Table 47: Linking Protection mode function

5.4.5 Function Setpoint offset

The Setpoint offset function makes it possible to change the predefined setpoint temperature for the current operating mode in the thermostat by pressing a button.

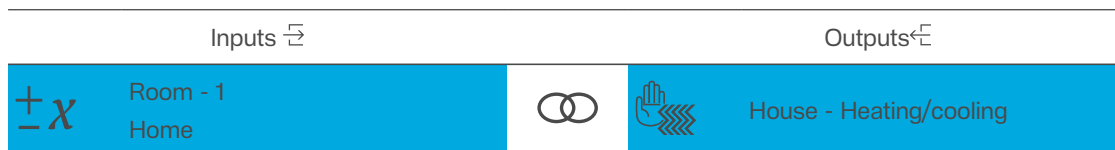

Table 48: Linking Setpoint offset function

In addition, the status LED can be set to **Always on/off**; it is important to specify whether the value predefined in the thermostat should be permanently overwritten by the Setpoint offset.

Control	Output behaviour
0	Do <i>not</i> overwrite nominal temperature value
1	Overwrite nominal temperature value

Table 49: Overwrite nominal temperature value

The range of the setpoint shift is between -1 °C to +1 °C and is specified in steps of 0.5 °C.

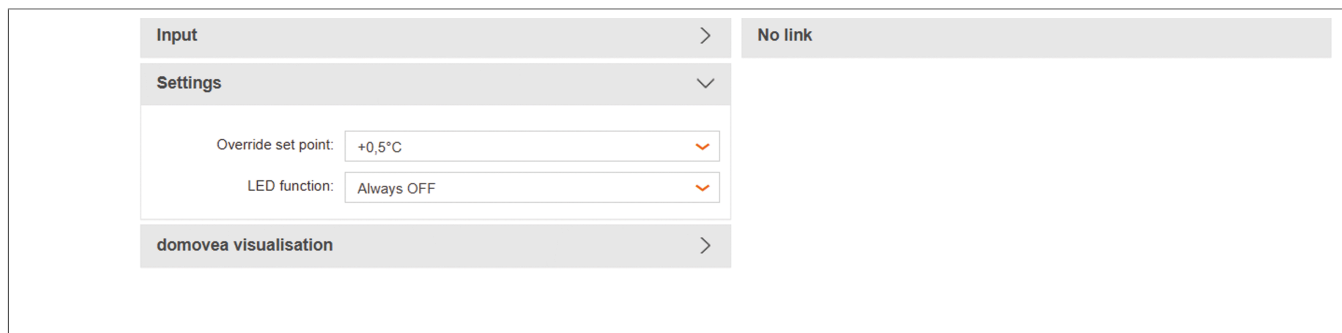

Fig. 30: Setpoint offset settings

5.4.6 Function Priority comfort toggle

With the **Priority comfort toggle** function, the operating mode which is currently running is interrupted and the thermostat is set to **Comfort** mode.

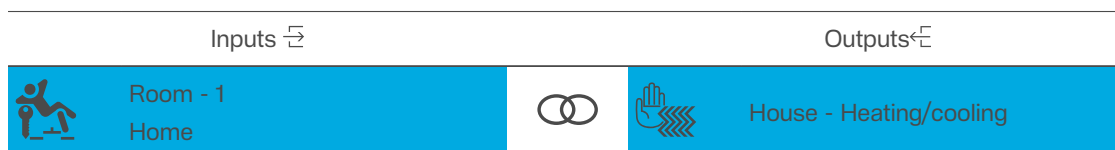

Table 50: Linking Priority comfort toggle function

Forced mode is switched on with a 1-command and off with a 0-command.

Control	Output behaviour
0	Switch off forced mode
1	Switch on forced mode

Table 51: Overwrite nominal temperature value

Example: Extending the Comfort operating mode

The **Priority comfort toggle** function can be used to prevent the previously set operating mode change-over and force the **Comfort** operating mode during events which are going to end later, for example. Once the event has finished, the forced operating mode is switched off and the actual operating mode is switched on. This is done with the same button (Toggle mode).

5.4.7 Priority protection toggle function

With the **Priority protection toggle** function, the operating mode which is currently running is interrupted and the thermostat is set to **Protection** mode.

Forced mode is switched on with a 1-command and off with a 0-command.

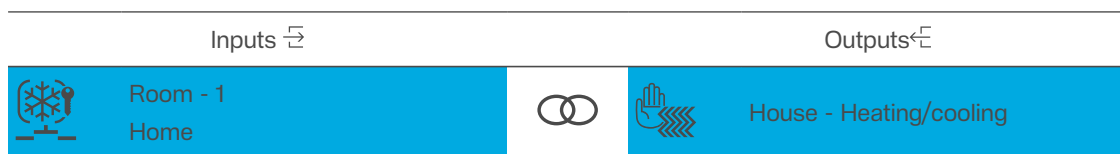

Table 52: Linking Priority protection toggle function

Example: Extending the Protection operating mode

The **Priority protection toggle** function can be used to prevent the previously set operating mode change-over and force the **Protection** operating mode during periods of extended absence. Once a person has returned, the forced operating mode is switched off and the actual operating mode is switched on. This is done with the same button (Toggle mode).

5.4.8 Function Heating / cooling toggle

This function switches between heating and cooling each time a button is pressed.

If the **Heating** function is switched on, the **Cooling** function is switched on and the **Heating** function switched off when the button is pressed.

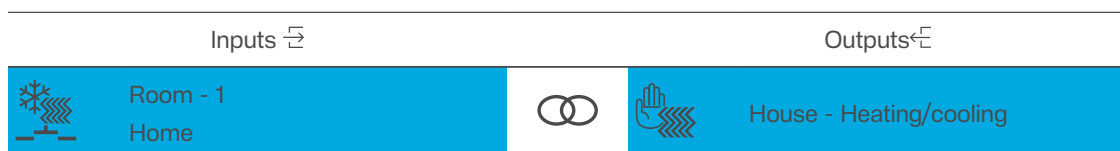

Table 53: Linking Heating/cooling toggle function



To use this function, the heating/cooling system must be designed to support both heating and cooling modes.

5.4.9 HVAC mode switch

This function switches off the heating or cooling system each time a button is pressed.



Inputs ↗		Outputs ↘	
	Room - 1 Home		Air conditioners with certified protocols via KNX gateway

Table 54: Linking HVAC mode switch function

 To use this function, the heating/cooling system must be designed to support both heating and cooling modes.

5.4.10 Increase/decrease the setpoint

Increase the setpoint value

This function increases the setpoint value each time the button is pressed.



Inputs ↗		Outputs ↘	
	Room - 1 Home		Air conditioners with certified protocols via KNX gateway

Table 55: Linking Increase setpoint function

Decrease the setpoint value

This function increases the setpoint value each time the button is pressed.



Inputs ↗		Outputs ↘	
	Room - 1 Home		Air conditioners with certified protocols via KNX gateway

Table 56: Linking Decrease setpoint function

5.4.11 Scene function

The detailed description of the Scene function can be found in Chapter 5.1.7 "Scene function", page 32.

5.4.12 Automatic control deactivation toggle

The detailed description of the **automatic control deactivation toggle** function can be found in chapter 5.1.8 "Automatic control deactivation toggle", page 33

5.4.13 Overview of all possible linking combinations

The following overview shows all linking combination possibilities for the **Heating/cooling** function. It is worth noting that inputs can also be linked with inputs (depending on the function selection).



Linking			
Input ↗		Input ↘	
	815820xx -1 Home		 Comfort mode

Table 57: Linking input – input Heating/Cooling

Independent push-button configuration

Functions Heating/cooling



















	Eco mode
	Standby mode
	Protection mode
	Automatic heating mode
	Heating switching mode
	Switching Comfort/Eco mode
	Switching Comfort/Standby mode
	Automatic protection mode
	Setpoint Offset
	Priority Comfort mode
	Priority Protection mode
	Priority Comfort toggle
	Priority Protection toggle
	Window status
	Heating/cooling switching
	Heating/cooling toggle
	Automatic Comfort mode
	Automatic Eco mode
	Automatic Standby mode

Table 57: Linking input – input Heating/Cooling

	Automatic protection mode
	Automatic heating toggle
	HVAC mode switching
	Increase the setpoint value
	Decrease the setpoint value

Table 57: Linking input – input Heating/Cooling

Linking	
Input	Output
Home	TXE530 - -1 - -1 Shading control

Table 58: Linking input – output Heating/cooling

5.5 Audio functions

The audio function makes it possible to control various IoT devices for audio transmission. However, the configuration of this function differs from that of standard KNX outputs (lighting, roller shutters, etc.). It is not possible to create a direct link in the easytool. Only the group address of the selected function can be exported to domovea. Assigning an audio function is done exclusively in domovea using the group address.

Audio
🔊 Audio source (external, controlled via the domovea via IoT link)
🔊 Audio on
🔊× Audio off
🔊🔊 Audio On Off
🔊+ Loudness +
🔊- Loudness -
🔊🎧 Audio favourite
🎨 Scene
🔊🔊 Automatic control deactivation toggle

Table 59: Overview of Audio functions

- 1 Select the input of the product.
- 2 Under **Input - Function**, select the appropriate audio function (1).

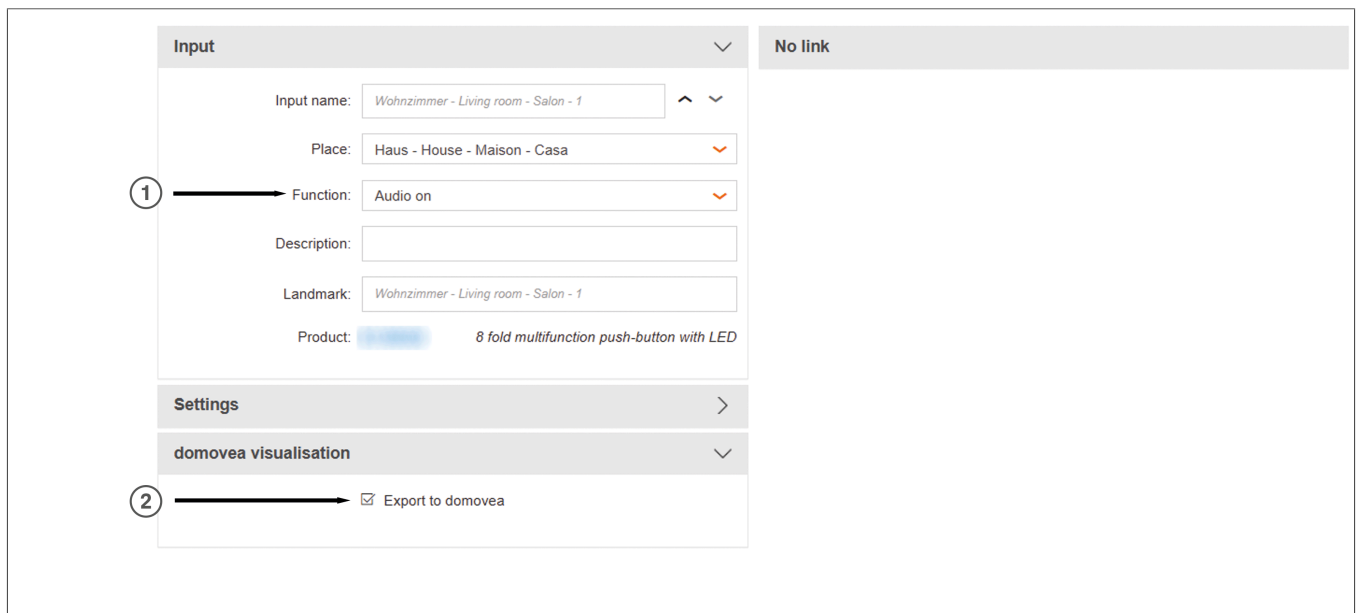

Fig. 31: Select the audio function

- 3 Select the **Export to domovea** check box (2).

In the domovea, the input is now visible with its own group address. This group address must then be assigned to the corresponding object of the IoT device function.

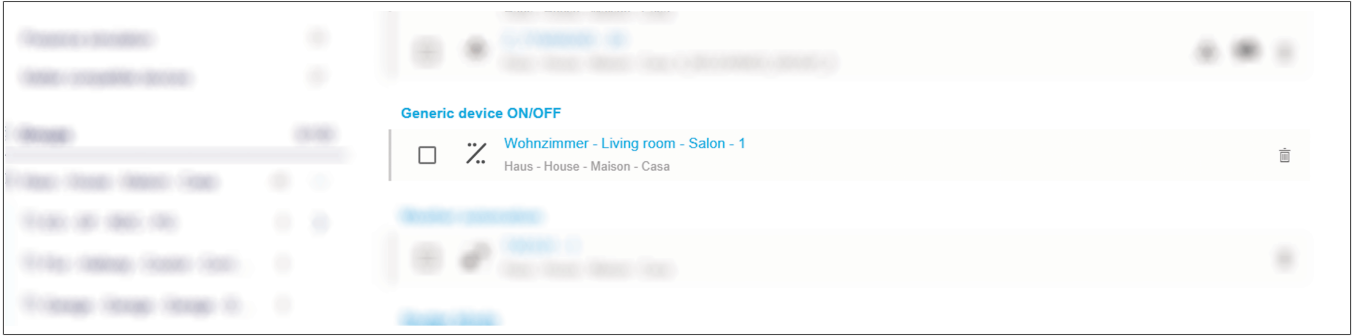

Fig. 32: Result – domovea export

Audio On/Audio Off function

With the Audio On/Audio Off function, pressing a button on the device will either turn the connected music source on or off.

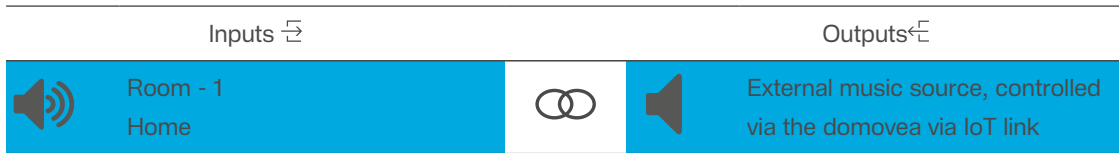

Table 60: Linking Audio ON function

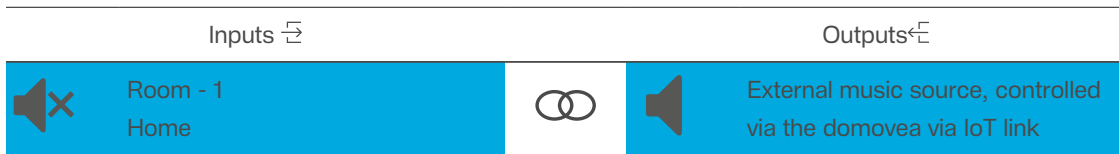

Table 61: Linking Audio OFF function

Audio On function

When the Audio On function is off, pressing a button on the device causes the connected music source to be switched on or off (Toggle function).

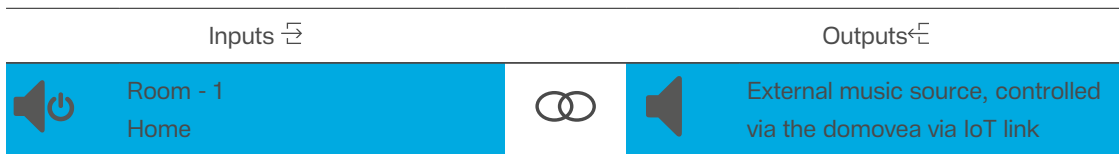

Table 62: Linking Audio On/Off function

Volume + / Volume -

With the Volume + / Volume - function, pressing a button on the device increases or decreases the volume of the connected music source.

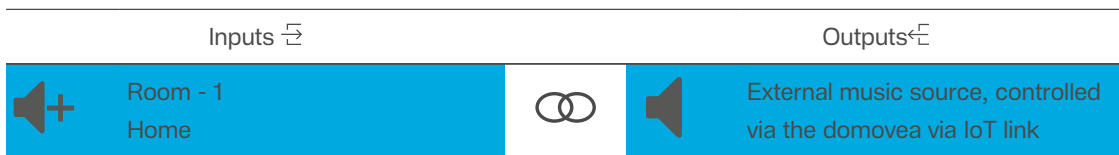

Table 63: Linking Volume + function

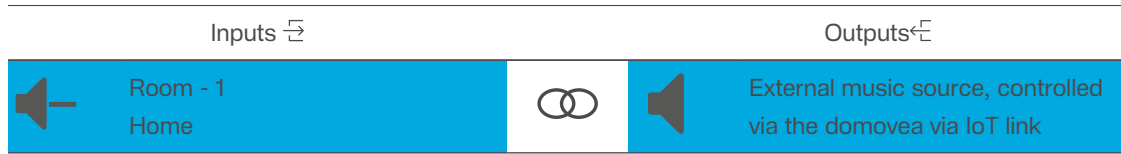

Table 64: Linking function volume -

Audio favourite function

With the Audio favourite function, pressing a button on the device causes the connected music source to play the stored audio favourite file.

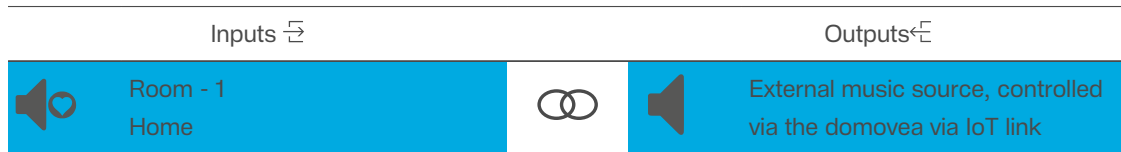

Table 65: Linking Audio favourite function

5.5.1 Scene function

The detailed description of the Scene function can be found in Chapter [see "Scene function", page 32](#).

5.5.2 Automatic control deactivation toggle

The detailed description of the **deactivate automatic control toggle** function can be found in chapter [see "Automatic control deactivation toggle", page 33](#).

5.5.3 Overview of all possible linking combinations

Linking	
Input ↗	↘ Input
Audio on	External music source, controlled via the domovea via IoT link
Audio off	
Audio On Off	
Loudness +	
Loudness -	
Audio Favorite	

Table 66: Combination possibilities Audio input - external sources

6 Temperature sensor function parameters

The following section describes and explains the configuration and settings of the internal and external temperature sensors.



Both temperature sensors can be activated/deactivated independently from one another, which means that they can also be set separately.

6.1 Internal temperature sensor

The device is directly fitted with a sensor for temperature measurement.



The measured temperature can be transmitted directly to a KNX thermostat as a second measuring point (measurement result) and can be used to synchronise the global actual temperature (synchronisation in larger rooms).

Room temperature recorded as a measurement result for building visualisation

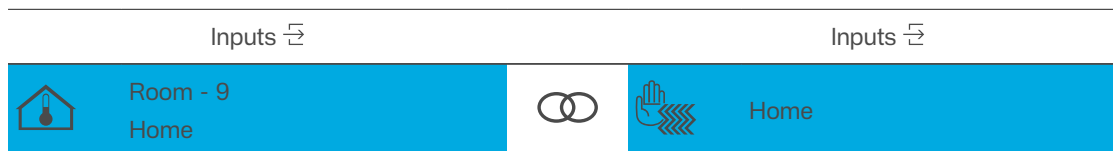

Table 67: Linking input - input Internal temperature sensor function

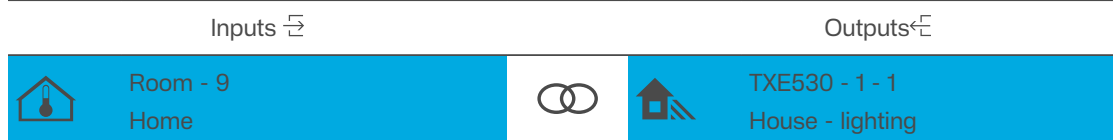

Table 68: Linking input - output Internal temperature sensor function

6.2 External temperature sensor

The external temperature sensor is a cable-based remote sensor that can be connected to the bus coupler (see accessories) directly. The temperature measured can therefore be transmitted to the BUS.



In addition, the externally measured temperature can be transmitted directly to a KNX thermostat as a second measuring point (measurement result) and can be used to synchronise the floor temperature (synchronisation in larger rooms).

The ambient temperature, for example, recorded as the measurement result when the push button is in an unfavourable location for installation (outside, etc.).

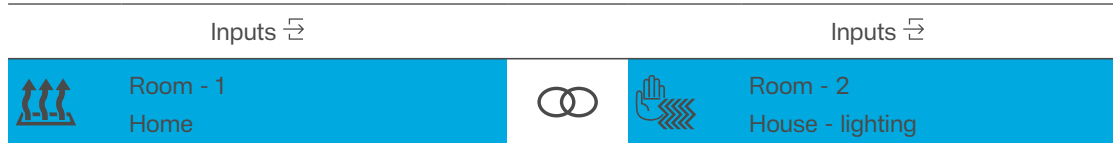

Table 69: Linking input - input Internal temperature sensor function

When selecting an installation position for the device or the external sensor, observe the following:

- Integrating the push-button into multiple combinations should be avoided especially when a flush-mounted dimmer is also installed.
- The sensors should not be installed close to large electrical loads (due to heat radiation).
- Installation near radiators or cooling systems should be avoided.
- The temperature sensor must be kept out of direct sunlight.
- Mounting sensors on the interior side of external walls may negatively affect the temperature measurement.
- Temperature sensors should be installed at least 30 cm away from doors and windows and at least 1.5 m above the floor.

The temperature is actually controlled only by the thermostat.

7 Appendix

7.1 Technical data

KNX Medium	TP1-256
Commissioning mode	system link, easy link
KNX supply voltage	21 ... 32 V $\overline{\text{SELV}}$
BUS connection mode	Bus connection terminal
KNX current consumption	Typ. 30 mA
Power consumption	typ. 150 mW
Degree of protection	IP20
Overvoltage class	III
Operating height	Max. 2000 m
Operating temperature	-5° ... +45°C
Storage/transport temperature	-20° ... +70°C
Dimensions	55 x 55 x 28 mm

7.2 Accessories

Accessories mandatory

Buttons for push-button module, 1-gang	8118 10xx
Buttons for push-button module, 1-gang, printed	8118 11xx
Buttons for push-button module, 1-gang, backlit	8118 12xx
Buttons for push-button module, 4-gang	8118 20xx
Buttons for push-button module, 4-gang, printed	8118 21xx
Buttons for push-button module, 4-gang, backlit	8118 22xx
Buttons for push-button module, 6-gang	8118 30xx
Buttons for push-button module, 6-gang, printed	8118 31xx
Buttons for push-button module, 6-gang, backlit	8118 32xx
Buttons for push-button module, 8-gang	8118 40xx
Buttons for push-button module, 8-gang, printed	8118 41xx
Buttons for push-button module, 8-gang, backlit	8118 42xx

Optional accessories

Anti-theft protection PZO screw	8195 0000
KNX bus connection terminals, 2-pole, red/black	TG008
Floor temperature sensor	EK090
KNX system line Y(ST)Y, 2x2x0.8	TG01x

7.3 Accessories

Accessories mandatory

Cover for KNX push button, 1-gang	WAK7011xx
Cover for KNX push button, 1-gang, imprint	WAK7111xx
Cover for KNX push button, 1-gang, backlit	WAK7211xx
Cover for KNX push button, 4-gang	WAK7014xx
Cover for KNX push button, 4-gang, imprint	WAK7114xx
Cover for KNX push button, 4-gang, backlit	WAK7214xx
Cover for KNX push button, 6-gang	WAK7016xx
Cover for KNX push button, 6-gang, imprint	WAK7116xx
Cover for KNX push button, 4-gang, backlit	WAK7216xx
Cover for KNX push button, 8-gang	WAK7018xx
Cover for KNX push button, 8-gang, imprint	WAK7118xx
Cover for KNX push button, 8-gang, backlit	WAK7218xx

Optional accessories

Anti-theft protection PZO screw	WDA9091
KNX bus connection terminals, 2-pole, red/black	TG008
Floor temperature sensor	EK090
KNX system line Y(ST)Y, 2x2x0.8	TG01x

7.4 Accessories

Mandatory accessories

Mounting ring	WH409500E
Mounting ring	WH409500F

Optional accessories

KNX bus plug-in terminals, 2-pole, red/black (included in scope of delivery)	TG008
Floor temperature sensor	EK090
KNX system cable, Y(ST)Y, 2x2x0.8	TG01x



Berker GmbH & Co. KG
Zum Gunterstal

66440 Blieskastel
Germany

T +49 6842 945 0
F +49 6842 945 4625
info@berker.de
berker.com