

Light control Power supply module — extension

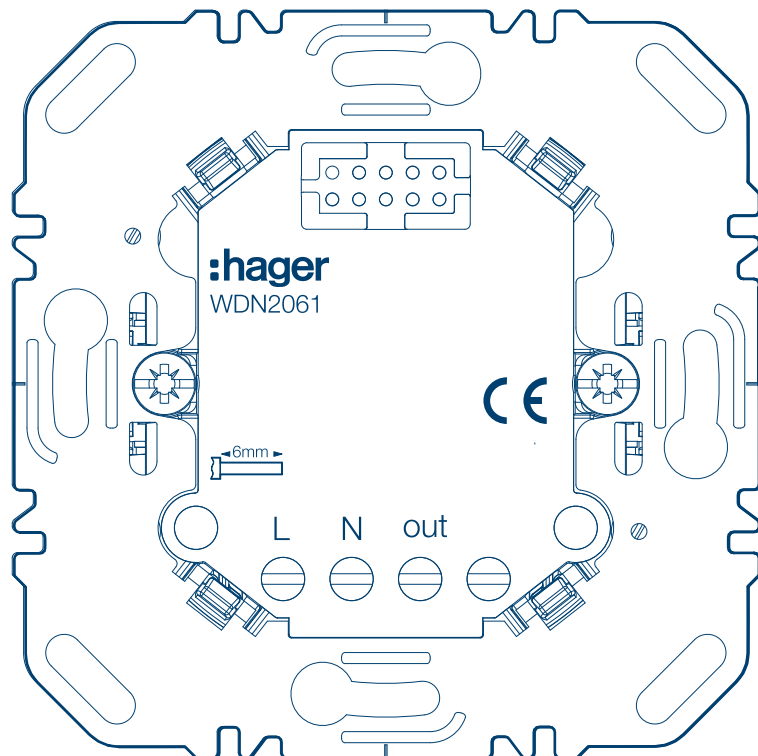

Power supply module — extension
WDN2061

CE

| | | |
|----------|--|-----------|
| 1 | Introduction..... | 3 |
| 2 | Safety instructions..... | 4 |
| 3 | Design and layout of the device..... | 5 |
| 3.1 | Dimensions..... | 5 |
| 4 | Function..... | 6 |
| 4.1 | Intended use..... | 6 |
| 5 | Operation..... | 7 |
| 6 | Installation and electrical connection..... | 8 |
| 7 | Technical data..... | 11 |
| 8 | Accessories..... | 12 |
| 9 | Disposal note..... | 13 |

1 Introduction

These instructions describe the installation of the power supply module. The device is part of the modular electronics platform, which can be connected via the Matter wireless standard.

In addition to the Quick Guide provided with the product, you can find:

- Use as a radio control station in combination with a suitable radio application module
- Use as a wired motion detector extension unit in combination with a motion detector application module
- Suitable accessories



▶ Also follow the operating instructions for the application module required for operation (e.g. motion detector application module). They explain the operation of the complete device and the corresponding setting options.

System overview

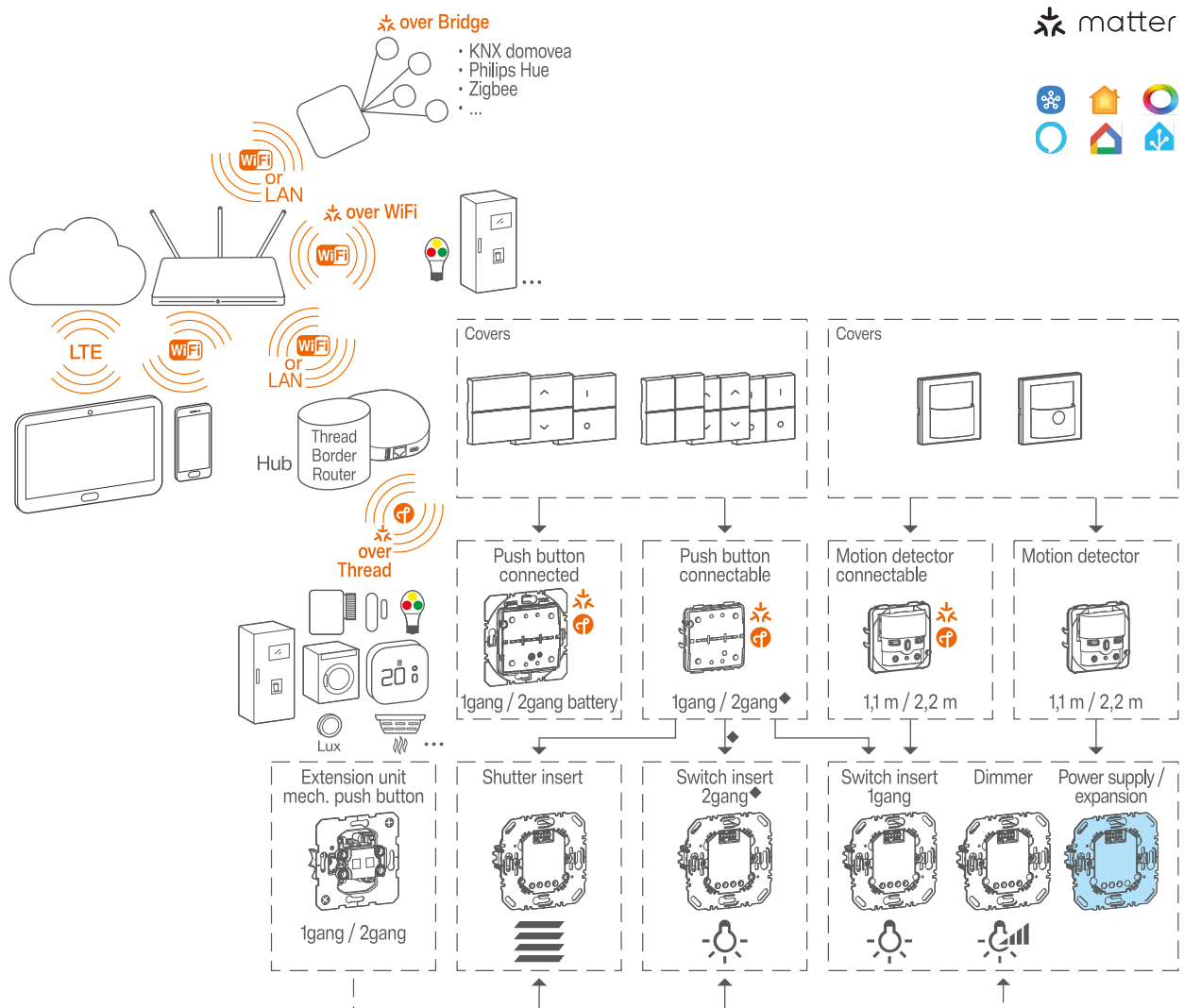

2 Safety instructions

Electrical devices may only be installed and assembled by a qualified electrician in accordance with the relevant installation standards, guidelines, regulations, directives, and safety and accident prevention regulations of the country of installation.

Failure to comply with these installation instructions may result in damage to the device, fire or other dangers.

Danger due to electric shock. Do not operate the device without application module.

3 Design and layout of the device

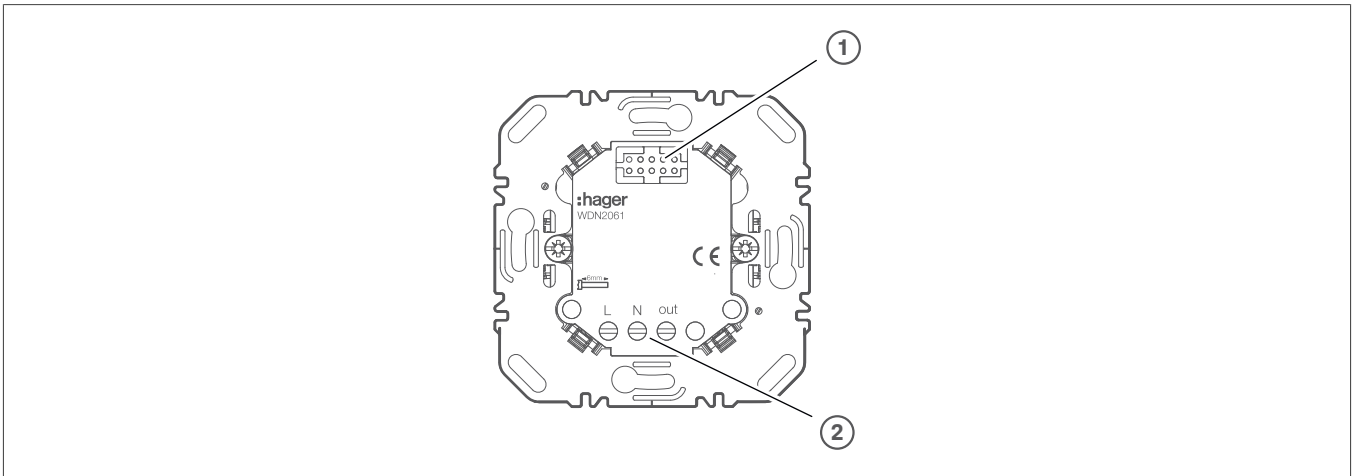

- ① Interface between insert/application module
- ② Connecting terminals

3.1 Dimensions

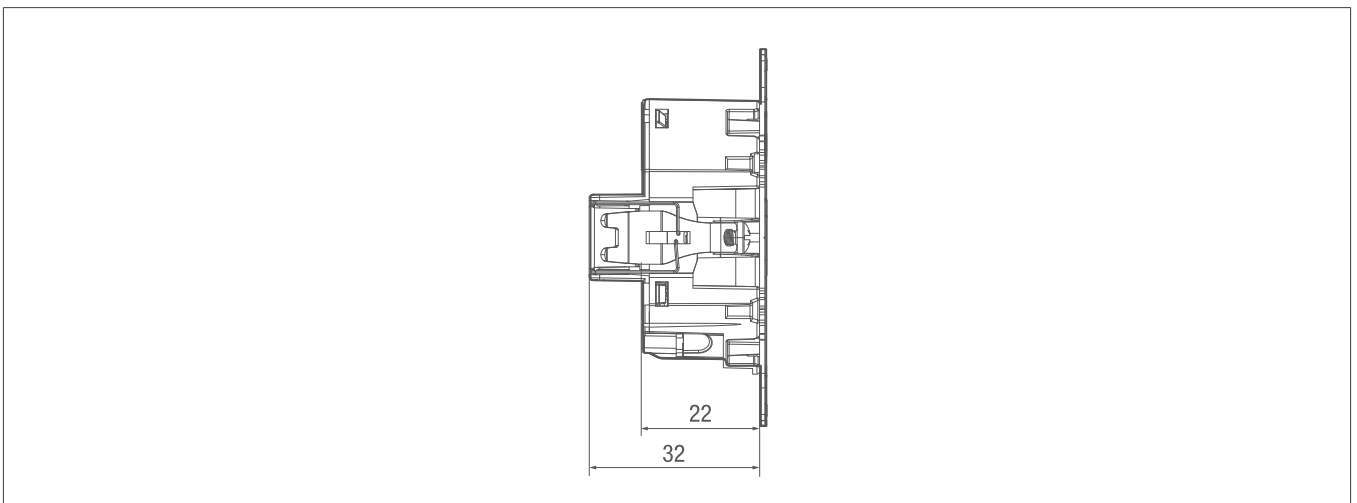

Fig. 1: Built-in depth

4 Function

4.1 Intended use

Power supply modules for connectable application modules (see 'Accessories')

Can be used in combination with a motion detector application module as a wired motion detector extension unit for a motion detector main unit



Only suitable for use in indoor areas with no drip and no spray of water

DIN 49073



Installation into wall box according to DIN 49073 (recommendation: Deep box)



Operation with suitable application module (see 'Accessories')



Not usable as a wired extension unit when using a button module as an application module.

5 Operation

Operation is described in the instructions of the respective application module (see 'Accessories').



Operation is only possible if a suitable application module is attached to the insert.

When used as an extension unit, operation is only possible if there is a suitable application module on the main unit.

6 Installation and electrical connection



Danger

Electric shock when live parts are touched!

An electric shock can lead to death!

- Disconnect all connection cables before working on the device and cover any live parts in the area!

☑ A miniature circuit breaker in accordance with the connection diagram must be installed as device protection.

- 1 Connect the device according to the connection diagram (Figure 2 or 3).

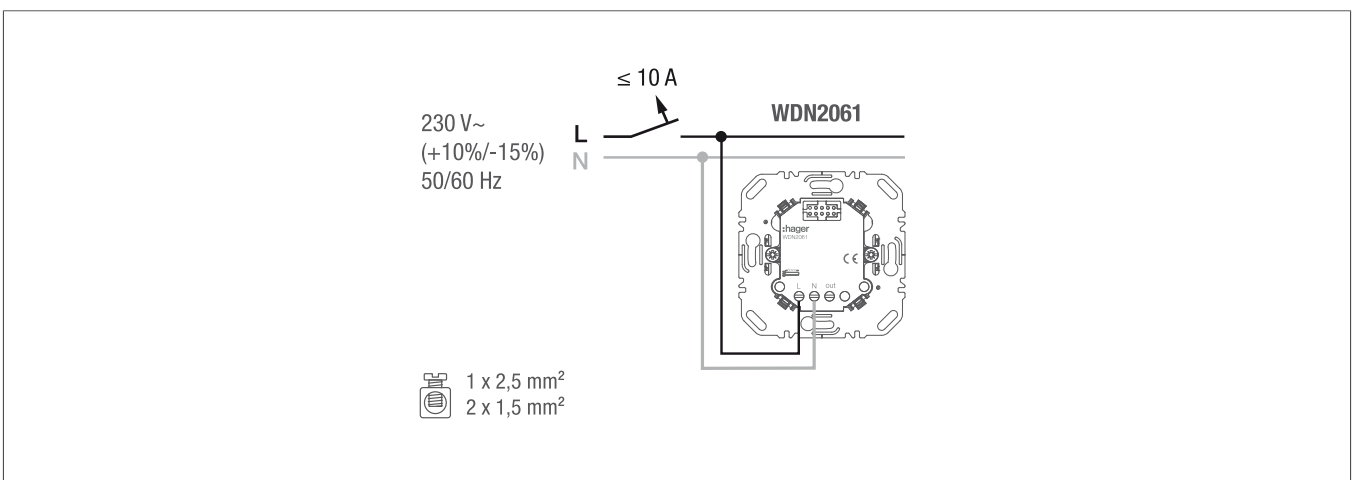

Fig. 2: Connection diagram — Use as power supply module for connected application module

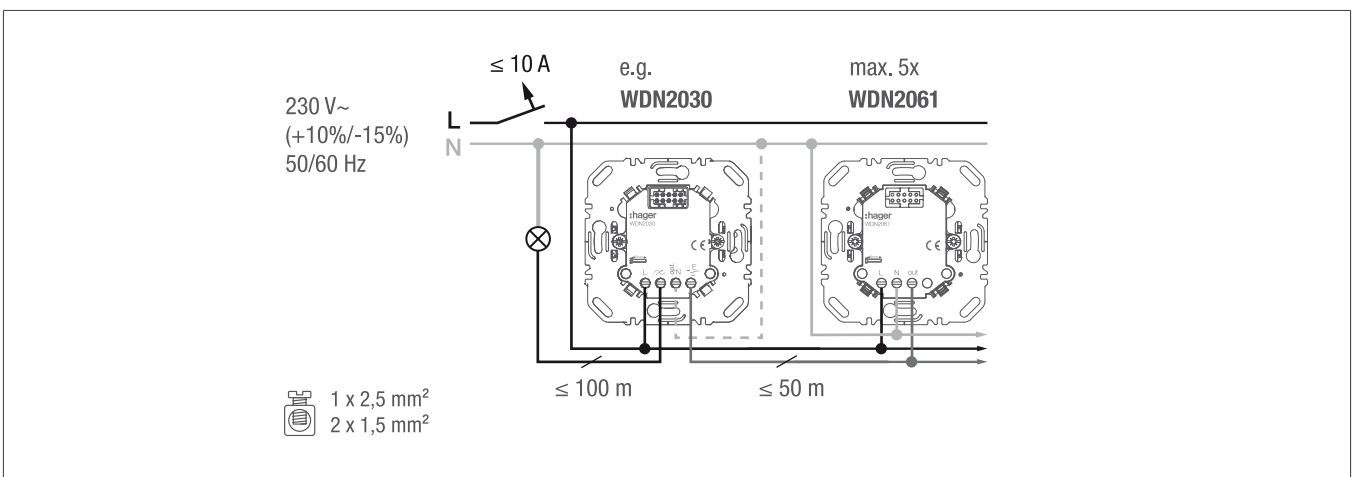
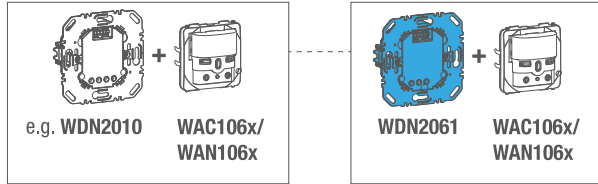

Fig. 3: Connection diagram — Use as a wired motion detector extension unit



Note on Fig. 3:

Use possible only if a motion detector application module with a suitable insert (e.g. WDN2010) is used as the main unit.



Motion detector main unit

Motion detector extension unit



Not usable as a wired extension unit when using a button module as an application module.

Installation and electrical connection

- 2 Install the device into a wall box. The connection terminals must be at the bottom.

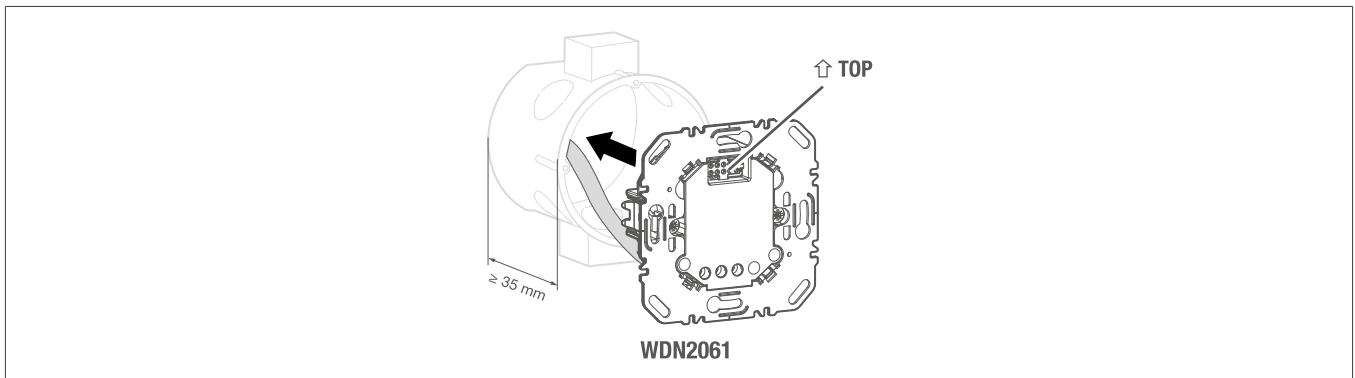



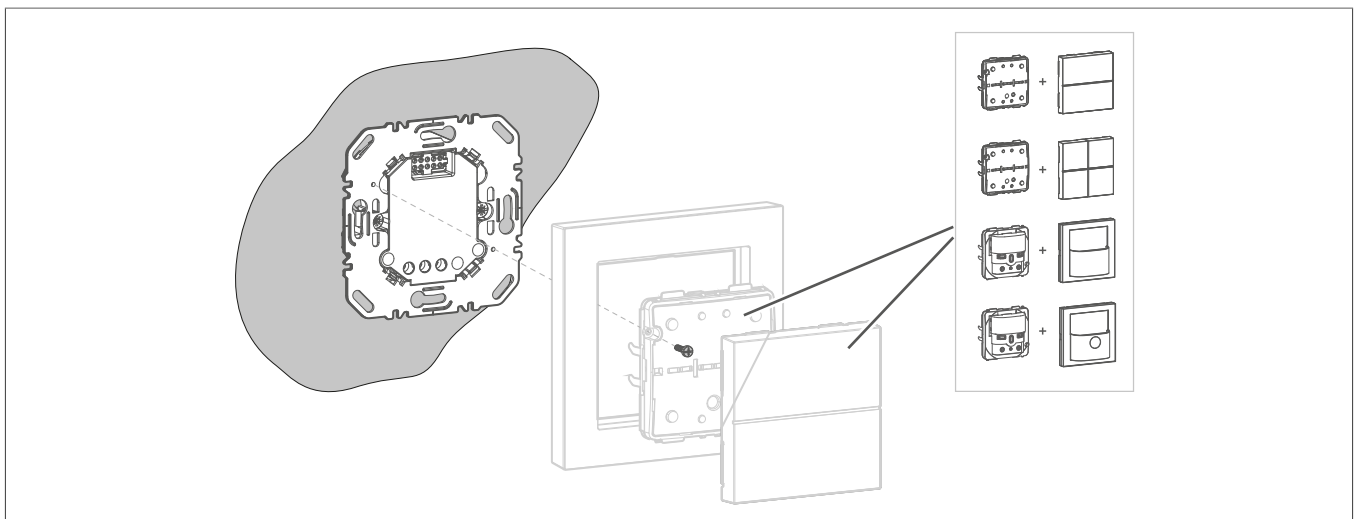















- 3 Mounting the frame and application module ► Follow the instructions for the application module used.
- 4 Secure the application module to the insert using the fixing screw.
- 5 Install the appropriate cover.

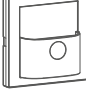

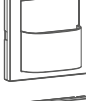
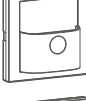
7 Technical data

| | |
|----------------------------------|---|
| Nominal voltage | AC 230 V~ (+10%/-15%) |
| Mains frequency | 50/60 Hz |
| Miniature circuit breaker | max. 10 A |
| Power consumption (standby) | < 0.1 W |
| Connecting terminals | 1 x 2.5 mm ² or 2 x 1.5 mm ² |
| Built-in depth housing | 22 mm |
| Claw guidance installation depth | 32 mm |
| Operating temperature | -5°C ... +45°C |
| Storage/transport temperature | -20°C ... +60°C |
| Relative humidity | 10 ... 95% (without condensation) |
| Degree of protection | IP20 |

8 Accessories

| Compatible application modules | | + Correct covers | | | | | |
|--|--|--|-----------|---|-----------|---|-----------|
|  | WAC1010 Matter compatible push button, 1-gang |  | WAN7010xx |  | WAN7050xx |  | WAN7011xx |
|  | WAC1020 Matter compatible push button, 2-gang |  | WAN7020xx |  | WAN7051xx |  | WAN7021xx |
|  | WAC1061 Matter compatible motion detector, installation height 1.1 m |  | WAN7030xx |  | WAN7040xx | | |
|  | WAC1062 Matter compatible motion detector, installation height 2.2 m |  | WAN7030xx |  | WAN7040xx | | |
|  | WAN1061 Motion detector, installation height 1.1m |  | WAN7030xx |  | WAN7040xx | | |
|  | WAN1062 Motion detector, installation height 2.2m |  | WAN7030xx |  | WAN7040xx | | |

9 Disposal note

Disposal note



Correct disposal of this product (electrical waste).

(Applicable in the European Union and other European countries with separate collection systems)

This marking shown on the product or its documentation indicates that it should not be disposed of with other household waste at the end of its working life. To prevent possible harm to the environment or human health from uncontrolled waste disposal, please separate this device from other types of waste. Recycle the device responsibly to promote the sustainable reuse of material resources.

Household users should contact either the dealer where they purchased this product, or their local government office, for details of where and how they can take this device for environmentally safe disposal.

Commercial users should contact their supplier and check the terms and conditions of the purchase contract. This product should not be mixed with other commercial waste for disposal.



Berker GmbH & Co. KG

Zum Gunterstal

66440 Blieskastel

Germany

T +49 6842 945 0

F +49 6842 945 4625

info@hager.com

hager.com