

Light control

Switch insert, 1-gang

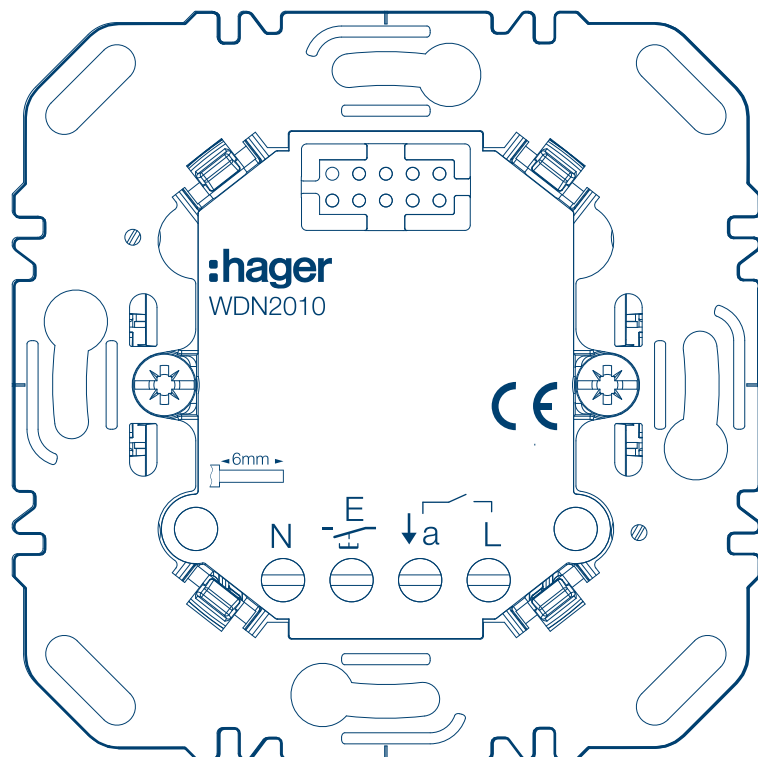

Switch insert, 1-gang, 10 A
WDN2010

CE

1	Introduction.....	3
2	Safety instructions.....	4
3	Design and layout of the device.....	5
3.1	Dimensions.....	5
4	Function.....	6
4.1	Intended use.....	6
5	Operation.....	7
6	Installation and electrical connection.....	8
7	Technical data.....	11
8	Accessories.....	12
9	Troubleshooting.....	13
10	Disposal note.....	14

1 Introduction

This manual describes the installation of the switch module, 1-gang. The device is part of the modular electronics platform, which can be connected via the Matter wireless standard.

In addition to the Quick Guide provided with the product, you can find:

- Details on how to use extension units
- Important information about connected loads
- Suitable accessories
- Troubleshooting



► Also follow the operating instructions for the application module required for operation (e.g. Push button, connectable, 1-gang). They explain the operation of the complete device and the corresponding setting options.

System overview

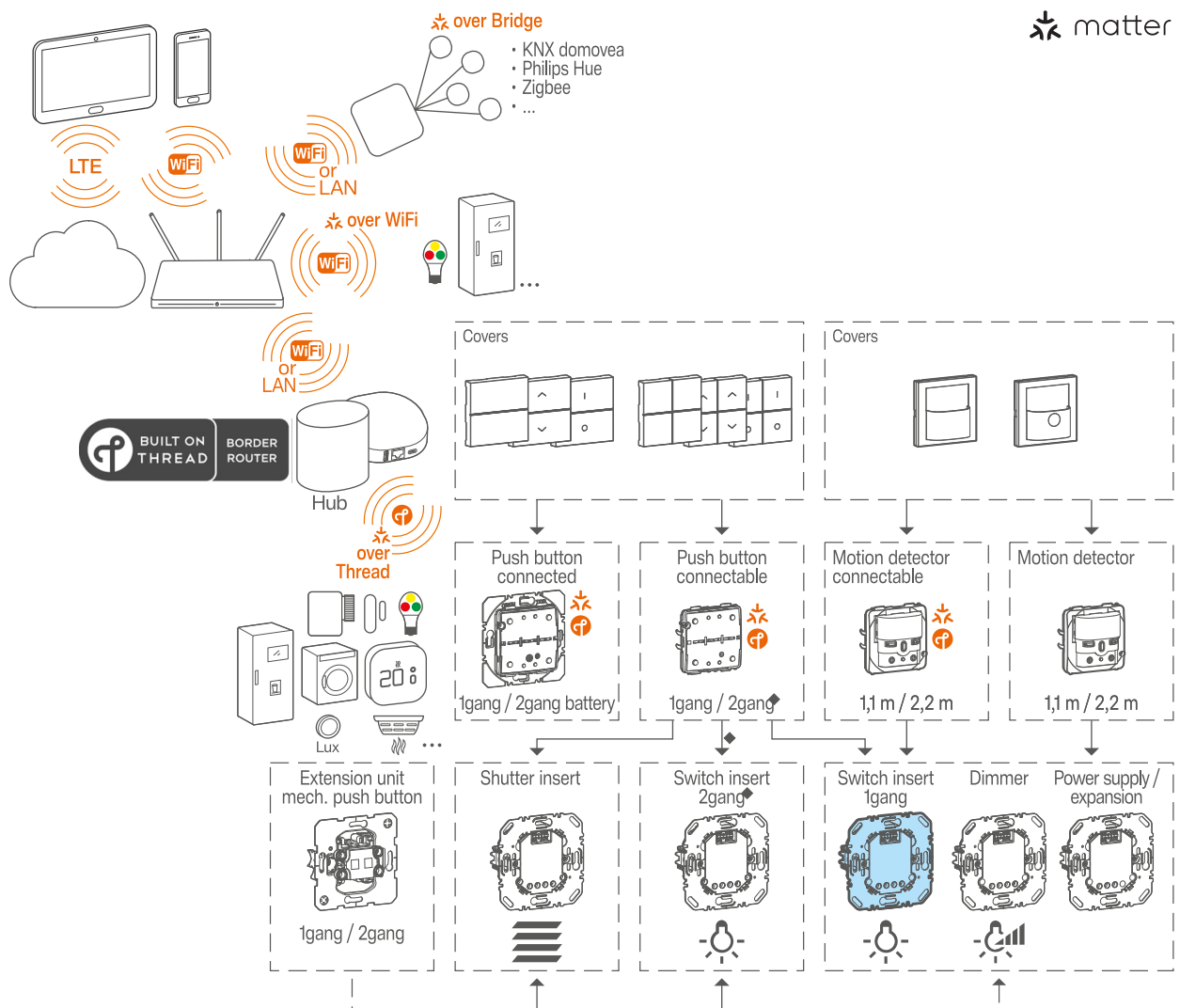

2 Safety instructions

Electrical devices may only be installed and assembled by a qualified electrician in accordance with the relevant installation standards, guidelines, regulations, directives, and safety and accident prevention regulations of the country of installation.

Failure to comply with these installation instructions may result in damage to the device, fire or other dangers.

Danger due to electric shock. Do not operate the device without application module. Secure the application module to the insert using the fixing screw.

Fire hazard. A miniature circuit breaker with tripping characteristic B in accordance with the connection diagram must be installed for protection purposes.

Fire hazard. When operating with conventional transformers, secure each transformer on the primary side according to the manufacturer's specification. Use safety transformers that comply with EN 61558-2-6 (VDE 0570 Part 2-6) only.

3 Design and layout of the device

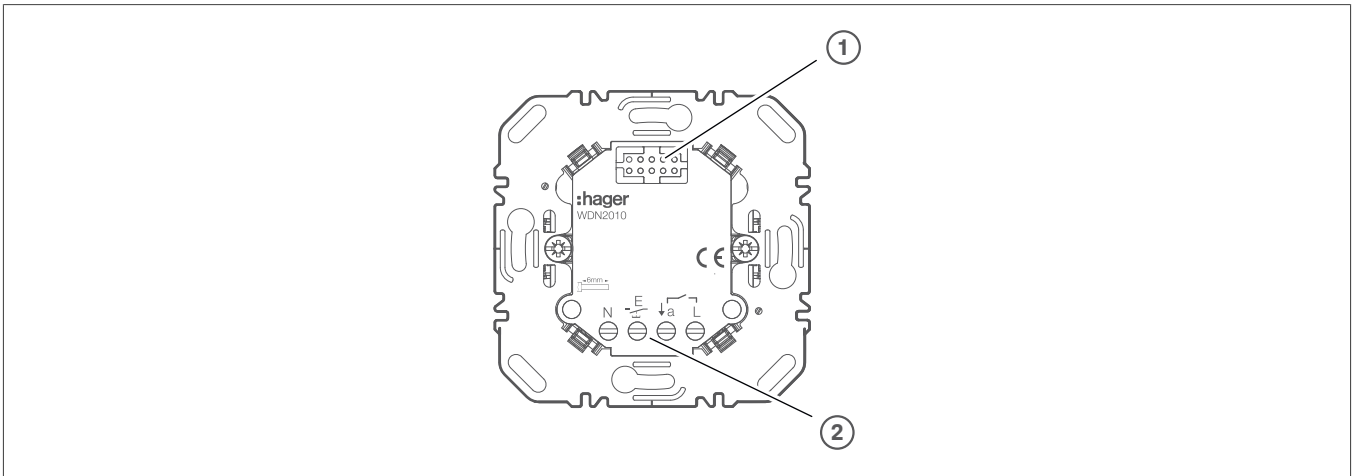

- ① Interface between insert/application module
- ② Connecting terminals

3.1 Dimensions

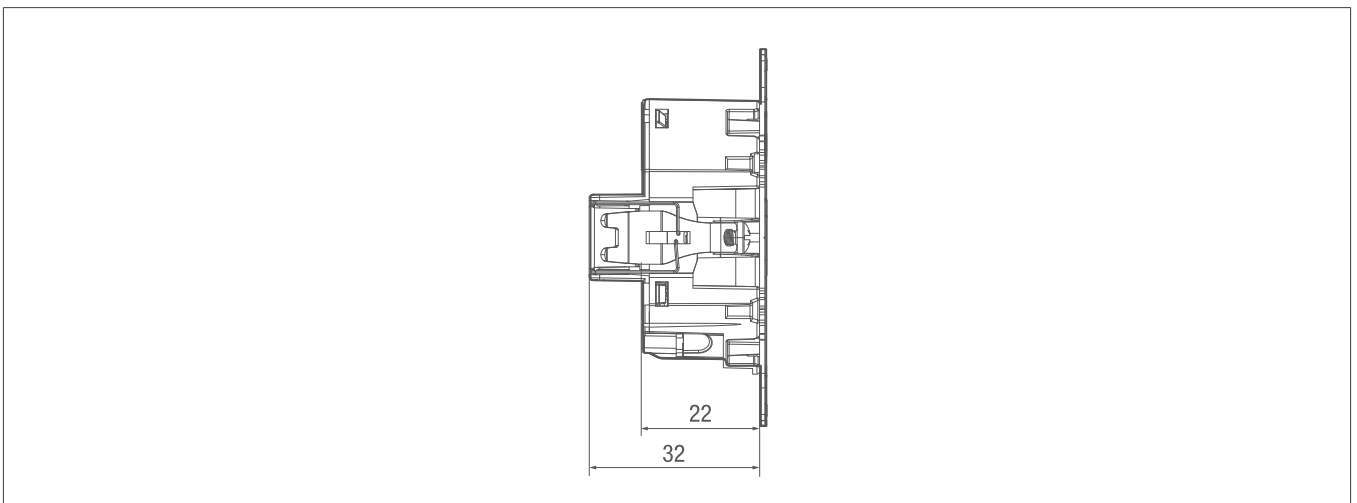

Fig. 1: Built-in depth

4 Function

4.1 Intended use



Switching lighting. For supported load types and performance values, see 'Technical data'.



Only suitable for use in indoor areas with no drip and no spray of water

Installation into wall box according to DIN 49073 (recommendation: deep box)

Operation with suitable application module (see 'Accessories')

5 Operation

Operation is described in the instructions of the respective application module (see 'Accessories').



Operation, including operation of extension units, is only possible if an application module is attached to the insert.

6 Installation and electrical connection



Danger

Electric shock when live parts are touched!

An electric shock can lead to death!

- Before working on the device, disconnect the power supply.
- Do not operate the device without application module.
- Secure the application module to the insert using the fixing screw.



Danger

Risk of destruction!

If the wrong type of miniature circuit breaker is used, the device may be destroyed in the event of a short circuit!

- Only use miniature circuit breakers with tripping characteristic B in accordance with the connection diagram.

A miniature circuit breaker in accordance with the connection diagram must be installed as device protection.

① Connect the device according to the connection diagram (Figure 2, 3 or 4).

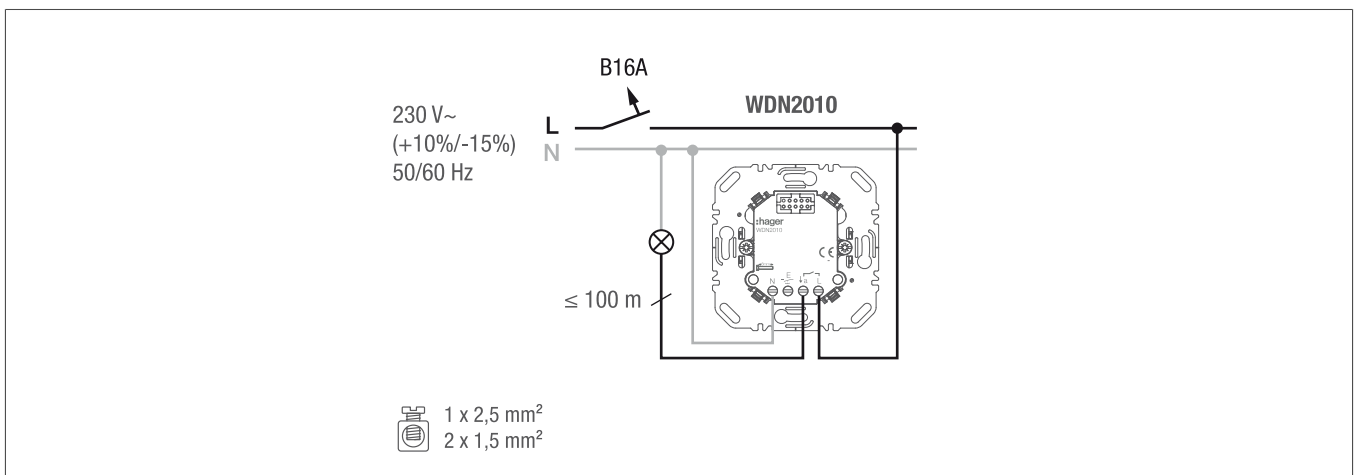

Fig. 2: Connection diagram

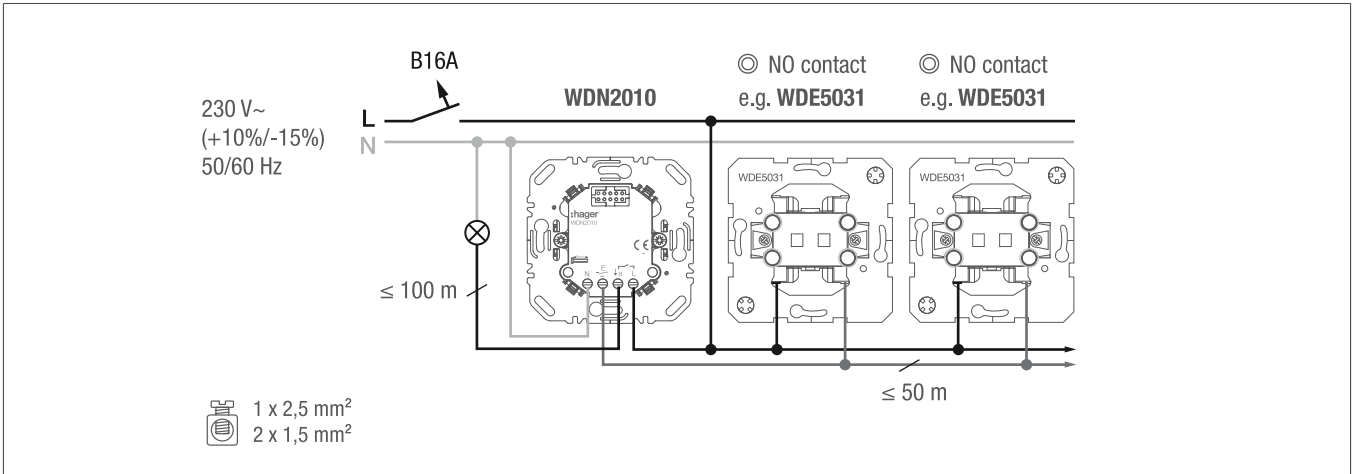

Fig. 3: Connection diagram with optional button extensions



Illuminated mechanical push button extension units must be equipped with a separate N terminal.

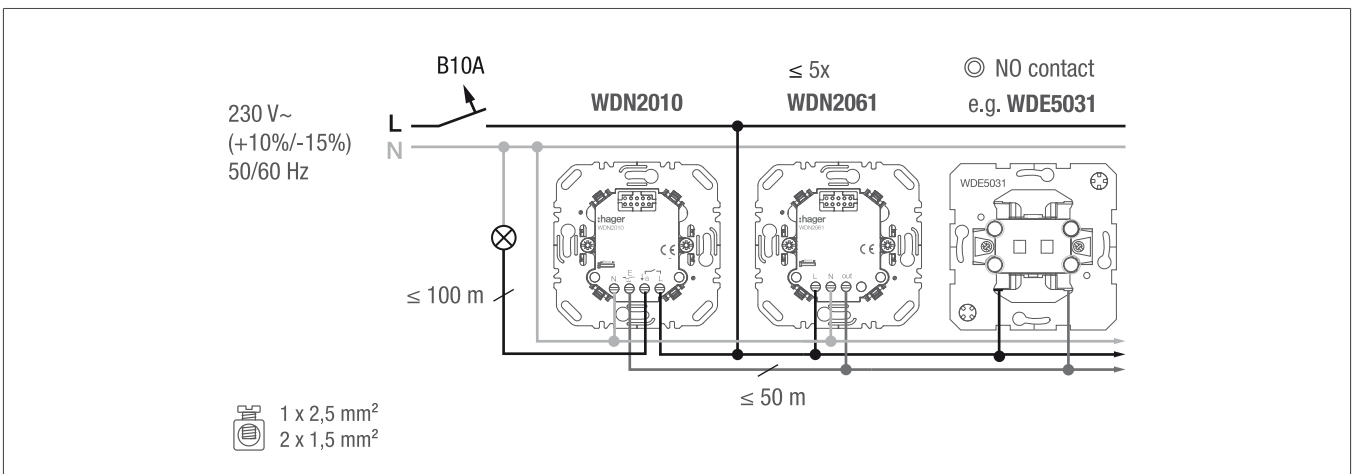
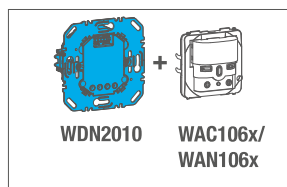

Fig. 4: Connection diagram with optional motion detector extension units and mechanical button extension units



Only use motion detector extension units if the switch insert is operated with a motion detector application module.



Motion detector main unit

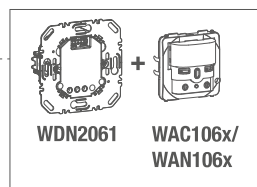

Motion detector extension unit



Note: If a WAC1010/WAC1020 button module is used as an application module, extension unit operation with the WDN2061 is not possible.

Installation and electrical connection

- 2 Install the device into a wall box. The connection terminals must be at the bottom.

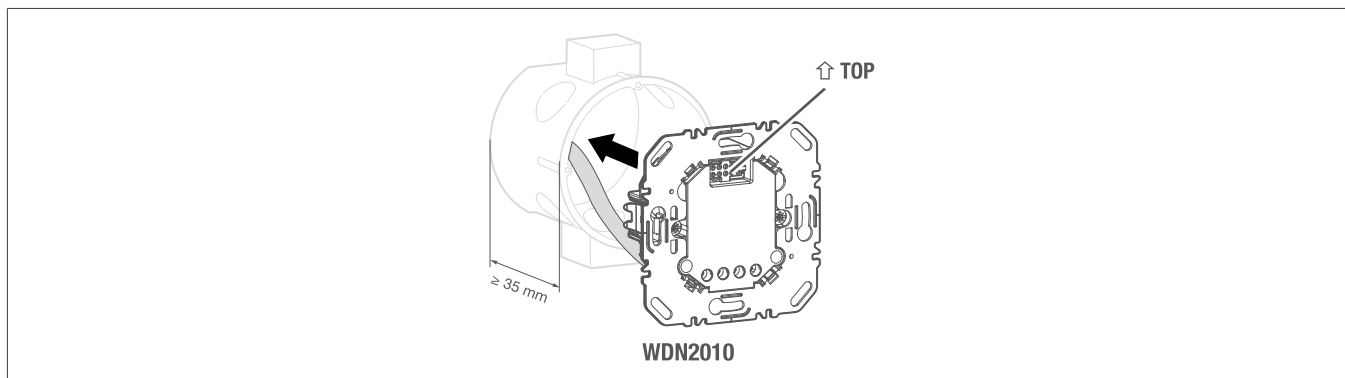

- 3 Mounting the frame and application module ► Follow the instructions for the application module used.
- 4 Secure the application module to the insert using the fixing screw.
- 5 Install the appropriate cover.

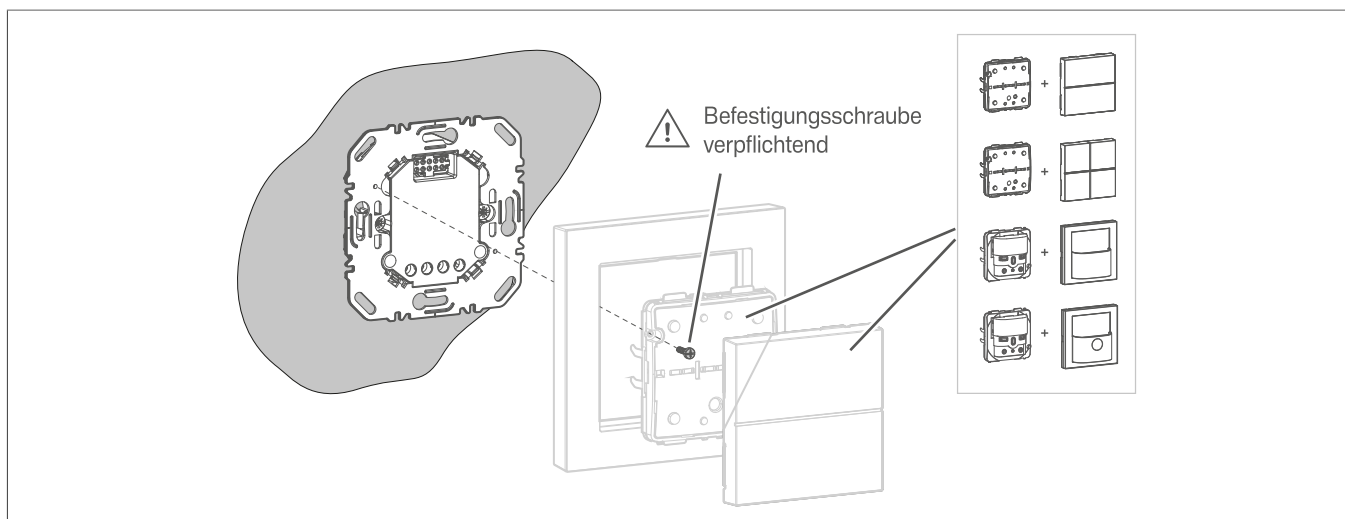

7 Technical data

Nominal voltage	AC 230 V~ (+10% / -15%)
Mains frequency	50/60 Hz
Power consumption (standby)	< 0.1 W
Type of contacts	μ-contact, NO contact
Minimum contact load	approx. 15 W
Connection terminal cross-sections	1 x 2.5 mm ² or 2 x 1.5 mm ²
Power cable length	Max. 100 m
Extension unit cable length	Max. 50 m
Number of extension unit push buttons, unilluminated	unlimited
Number of motion detector extensions (WDN2061 + top motion detector)	max. 5
Incandescent lamps	2300 W
HV halogen lamps	2300 W
LV halogen lamps with electronic transformers or dual-mode transformers	1500 VA
NV halogen lamps with conventional transformers	1500 VA
LED lamps 230 V (Retrofit LED)	350 W
LED lamps 230 V (Retrofit Filament LED)	500 W
Built-in depth housing	22 mm
Claw guidance installation depth	32 mm
Operating temperature	-5°C ... +45°C
Storage/transport temperature	-20°C ... +60°C
Relative humidity	5 ... 85 % (without condensation)
Degree of protection	IP20



Mixed loads possible to lowest maximum load.







Important information about transformers:

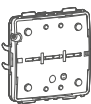
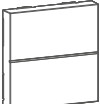
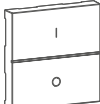
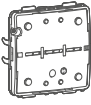
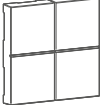
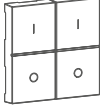

Use conventional or electronic transformers in accordance with the manufacturer's specifications.

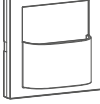
The performance data including transformer power loss are 20 % for inductive transformers and 10 % for electronic transformers.

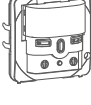
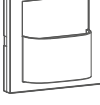
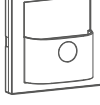
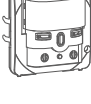
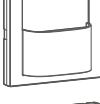
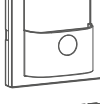
8 Accessories

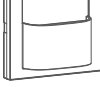
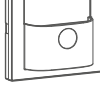
Compatible application modules			+ Correct covers			
	WAC1010	Matter compatible button module, 1-gang		WAN7010xx		WAN7011xx
	WAC1020	Matter compatible button module, 2-gang		WAN7020xx		WAN7021xx
	WAC1061	Matter compatible motion detector, installation height 1.1m		WAN7030xx		WAN7040xx
	WAC1062	Matter compatible motion detector, installation height 2.2m		WAN7030xx		WAN7040xx
	WAN1061	Motion detector, installation height 1.1m		WAN7030xx		WAN7040xx
	WAN1062	Motion detector, installation height 2.2m		WAN7030xx		WAN7040xx

9 Troubleshooting

Device can no longer be switched on.

Relay contact is oxidised.

💡 Increase connected load. Observe the minimum contact load (see 'Technical data').

Device switches on and can no more be switched off. The maximum permissible load has not been exceeded.

Relay have been overloaded due to excessive inrush currents. The device is damaged and must be replaced.

💡 Disconnect the device from any supply voltage before disassembling.

💡 Before replacing the device, check the connected load and replace it if necessary.

💡 Inrush current limiters available from specialist retailers can provide a solution. Comply with the manufacturer's data.

10 Disposal note

Disposal note



Correct disposal of this product (electrical waste).

(Applicable in the European Union and other European countries with separate collection systems)

This marking shown on the product or its documentation indicates that it should not be disposed of with other household waste at the end of its working life. To prevent possible harm to the environment or human health from uncontrolled waste disposal, please separate this device from other types of waste. Recycle the device responsibly to promote the sustainable reuse of material resources.

Household users should contact either the dealer where they purchased this product, or their local government office, for details of where and how they can take this device for environmentally safe disposal.

Commercial users should contact their supplier and check the terms and conditions of the purchase contract. This product should not be mixed with other commercial waste for disposal.



Berker GmbH & Co. KG

Zum Gunterstal

66440 Blieskastel

Germany

T +49 6842 945 0

F +49 6842 945 4625

info@hager.com

hager.com